



LIGHTING
2011-12



Right Hand Drive



The Hella Online Catalogue

Faster – always up to date – efficient



We offer an online catalogue on the internet, in addition to the printed catalogue. The online catalogue offers the key advantage of being constantly up to date. New products are immediately documented into the online catalogue.

When you start a product enquiry on the online catalogue, the ingenious search system will get you to the right answer in the quickest possible way. The vehicle-independent search function is invaluable, allowing you to research quickly all those products which are for universal use or multifunctional.

The online catalogue also provides detailed facts, additional information and topical links to further relevant documents.

For further information: www.hella.com/catalogue

Article Overview



Assembly Groups, Manufacturer, Product Groups Selection



Vehicle Selection



Article Document View



Hella KGaA Hueck & Co.
Rixbecker Straße 75
59552 Lippstadt/Germany
Tel.: +49(0)2941/38-0
Fax: +49(0)2941/38-7133
Internet: www.hella.com

Hella Asia Singapore Pte Ltd
Regional Headquarters Asia Pacific
Independent Aftermarket
2 International Business Park
#02-12 The Strategy
Singapore 609930

Tel: +65 6854 7300
Fax: +65 6854 7302
E-mail: singapore@hella.com
Internet: www.hella.com.sg

HELLA Automotive South Africa (Pty) Ltd
P O Box 6130
Moselville, Uitenhage,
SOUTH AFRICA
6232

Tel.: +27 (0) 41-996-5700
Fax.: +27 (0) 41-996-5720
<http://www.hella.co.za>

Hella-New Zealand Limited
P.O. Box 51427
81-83 Ben Lomond Crescent
Pakuranga, Auckland 1706
Telephone: (09) 577 0000
Facsimile: (09) 576-2476
Internet: www.hella.co.nz



Application Chart - Headlights, Signal and Sundry Lights for Cars	1.01-1.186	1
Application Chart - Headlights, Signal and Sundry Lights for Light Trucks	2.01-2.36	2
Application Chart - Headlights, Signal and Sundry Lights for Commercial Vehicles	3.01-3.82	3
Fog Lights, Driving Lights, Headlights, Work Lights and Search Lights	4.01-4.126	4
Signal Lights and Reflectors	5.01-5.234	5
Optical and Acoustic Warning Systems	6.01-6.59	6
Beamsetters	7.01-7.06	7
Bulbs	8.01-8.21	8
List of Part Numbers List of Type Approval Numbers Vehicle Manufacturer's No. - Hella No.	9.01-9.67	9

A		L	
Accessories for beamsetters series IV	7.02-7.03	Licence plate lights	5.153-5.157
Accessories for fog- and driving lights	4.25	Light series "5760"	4.47-4.49
Accessories for old-type of rotating/flashing beacons	6.23-6.25	Light series "Oval 100 / 120"	4.50-4.62
Accessories for rotating/flashing beacons	6.21-6.22	Light series "Module 120"	4.63-4.65
Accessories for work lights	4.122-4.125	Light series "Module 6213"	4.65-4.69
Assortments of bulbs for garages	8.06	Light series "7145"	4.69-4.70
Auxiliary indicators	5.181-5.183	Light series "001 240"	5.88
B		"001 259"	5.97-5.99
Beamsetters series IV and Economy	7.02-7.05	"001 423"	5.74
Built-in headlights	4.26-4.44	"002 582"	5.57
Bulbs with plastic caps	8.17-8.20	"002 776"	5.62
Bulb holders	8.20	"003 014"	5.102-5.103
Bulb overview	8.02	"003 018"	5.63
Bulb sets	8.03-8.05	"003 057"	5.100
Bulbs for headlights	8.06-8.12	"003 167"	5.29
Bulbs for signal lights	8.12-8.16	"003 182"	5.61
C		"003 184"	5.58
Clearance lights	5.158-5.161	"003 185"	5.63
Clearance- and position lights	5.143	"003 236"	5.105-5.107
Connectors	8.20-8.21	"003 389"	5.136-5.137
D		"003 734"	5.114-5.115
Daytime running lights	5.147-5.152	"003 748"	5.119
Door lights	5.220-5.222	"004 119"	5.112-5.113
Driving lights	4.03-4.24	"004 361"	5.121
E		"004 431/004 432"	5.108-5.109
Emergency triangles	5.228	"005 200"	5.105-5.107
External fitting headlights	4.45-4.46	"005 603"	5.112-5.113
F		"006 040"	5.25-5.27
Failure control for LED indicators	5.05-5.07	"006 717"	5.117
Flashing beacons	6.14-6.20, 6.26-6.28	"007 547"	5.28
Fog lights	4.03-4.24	"008 221"	5.65-5.66
H		"008 405"	5.64
Handlebar indicator lights	5.180	"008 645"	5.126-5.128
Handlights	5.216-5.219	"008 805"	5.111
Hazard flasher lights	5.226-5.227	"008 982"	5.109-5.110
Headlights, signal and sundry lights - application chart for cars	1.01-1.186	"009 001"	5.67-5.71
Headlights, signal and sundry lights - application chart for commercial vehicles and buses	3.01-3.81	"340 000"	5.125
Headlights, signal and sundry lights - application chart for light commercial vehicles	2.01-2.36	"340 001"	5.122-5.124
I		"343 130"	5.89-5.96
Indicator lights	5.173-5.179	"343 390"	5.89-5.96
Indicator-position lights	5.184-5.185	"343 640"	5.22-5.24
Interior lights	5.186-5.212	"343 690"	5.129-5.130
Information on LED technology headlights	4.02	"344 169"	5.79-5.86
Information on work lights	4.02	"344 200"	5.76-5.79
		"959 010/011"	5.75
		"959 037/050"	5.55-5.56
		"959 590/640/790"	5.134-5.135
		"959 820/821/822/950"	5.87
		"962 964"	5.116
		"963 639"	5.122-5.124
		"963 959"	5.120
		"964 169"	5.79-5.86
		"964 295"	5.131-5.132
		"965 039"	5.72-5.73
		"959 037/050"	5.55-5.56
		"996 012"	5.104
		"997 006"	5.60
		"997 027"	5.118
		"997 131"	5.59
		"998 232"	5.43
		"998 233"	5.43



Alphabetical Index

L		W	
List of part numbers	9.02-9.15	Warning lights	5.223-5.225
List of type approval numbers	9.54-9.67	Work lights	4.71-4.121
O			
Optical warning systems OWS 7: Product descriptions and spare parts	6.33-6.37		
Optical warning systems OWS 4: Spare parts for old-type systems	6.46		
Optical warning systems OWS 540 up to 1600: Product descriptions, accessories and spare parts	6.40-6.45		
Optical warning systems OWS-QS: Accessories and spare parts	6.38-6.39		
Optical warning systems Rapror: Product descriptions and accessories	6.31-6.32		
P			
Position lights	5.145-5.146		
R			
Reading lights	5.213-5.216		
Rear lights	5.107-5.109, 5.111		
Rear fog and reverse lights	5.163-5.166		
Rear- and position lights	5.141-5.142, 5.144		
Reflectors	5.229-5.234		
Reverse lights	5.167-5.168		
Rotating beacon and siren combinations RTK 7: Product descriptions and spare parts	6.47-6.49		
Rotating beacon and siren combinations RTK-VE 7: Product descriptions, modules and spare parts	6.54-6.55		
Rotating beacon and siren combinations RTK-VE: Product descriptions and accessories	6.55-6.59		
Rotating beacons, accessories and spare parts	6.04-6.13		
Rotating-/flashing beacon and siren combinations RTK-QS: Accessories and spare parts	6.50-6.53		
S			
Safety brake lights	5.169-5.172		
Search lights	4.126		
Side- marker lights	5.138-5.140		
Signal lights	5.08-5.54		
Spare parts for beamsetters series III	7.06		
Spare parts for old-type rotating/flashing beacons	6.23-6.25		
T			
Track-control lights	5.162		
V			
Vehicle manufacturer's no. - Hella no.	9.16-9.53		

Type approval numbers E1 - E24

All Hella devices have E type approval.

Exceptions to this are devices with national type approval that are only marked for Germany and equipment for local authority vehicles.

See overview of type approval numbers in Chapter 9.



What does GGVS/ADR mean?

Some headlights and lights in the range are marked with this symbol. This means that these products are approved for mounting to transport equipment which complies with the requirements of GGVS/ADR B Rn 10251 and Rn 11251 for electrical equipment.

GGVS

Act governing the transportation of hazardous goods by road

ADR

Accord européen relatif au transport international des marchandises dangereuses par route (European Agreement concerning the International Carriage of Dangerous Goods by Road)

What do the IP protective ratings mean?

Protective rating IP5K4K

Dust may only penetrate to such an extent that function and safety are not impaired.

Water being sprayed against the housing at increased pressure may not have a harmful effect; water pressure approx. 4 bar.

Protective rating IP6K4K

Dust must not penetrate.

Water being sprayed against the housing at increased pressure may not have a harmful effect; water pressure approx. 4 bar.

Protective rating IPX9K

Water that is directed against the housing during high-pressure/steam jet cleaning may not have a harmful effect; water pressure approx. 80 bar.

Decisive for the specification of the protective rating are the splashwater test and the dust test

The splash-water test provides information about how headlights, lights and beacons resist rain, splashwater, mud and high-pressure cleaners.

For this purpose, water is sprayed constantly onto the test specimen in a closed chamber as if through a high-pressure cleaner.

The dust test examines the degree to which the test specimen is protected against penetration by solid particles including dust.

For this purpose, the test sample is exposed to a flow of dust/air mixture for a certain length of time in the chamber.

Lighting technology - examples for terminal descriptions according to DIN 72552

54	Trailer signals, trailer plug fitting and light combinations, stop light
54g	Trailer signals, compressed air valve for permanent brake in the trailer, electromagnetic actuation
55	Fog lights
56	Headlight
56a	Headlight, spotlight and spotlight control
56b	Headlight, low beam
56d	Headlight, flashing lights
57	Parking light for motorbikes (outside Germany also for cars and trucks)
57a	Parking light
57L	Parking light left
57R	Parking light right
58	Position light, tail light, licence plate lighting and instrument lighting
58b	Tail light switchover for single-axle tractors
58c	Trailer plug fitting for tail light laid with a single wire and fused in the trailer
58d	Adjustable instrument lighting, tail light and position light
58L	Position light left
58R	Position light right



Headlights, Signal and Sundry Lights for Cars



1



List of Manufacturers/Page

1.01 - 1.05

Headlights, Signal and Sundry Lights -
Application Chart for Cars

1.06 - 1.186



List of Manufacturers/Page



Manufacturer	Model year	Page	Manufacturer	Model year	Page
Alfa Romeo			BMW		
145, 146 (930)	07/94->01/01	1.06	3 (E46) Compact	06/01->02/05	1.31
Audi			3 (E90/E91) Sedan, Touring	01/05->	1.31 - 1.32
A1 (8X0)	05/10->	1.06	3 (E92/E93) Coupé, Convert.	09/06->	1.33
A2 (8Z0)	02/00->08/05	1.06	5 (E28)	06/81->12/87	1.33
A3 (8L1)	09/96->05/03	1.06 - 1.07	5 (E34)	01/88->01/97	1.33 - 1.34
A3 (8P1, 8PA)	05/03->07/08	1.07 - 1.08	5 (E39)	11/95->06/04	1.34 - 1.39
A4 (8D2, 8D5, B5)	01/95->09/01	1.08 - 1.09	5 (E60, E61)	07/03->03/07	1.39 - 1.44
A4 (8E2, 8E5, B6)	11/00->12/04	1.09	5 (F10, F11)	03/10->	1.44 - 1.45
A4 (8EC, 8ED)	11/04->06/08	1.10	6 (E24)	04/76->09/90	1.45
A4 Convertible (8H7, 8HE)	01/06->	1.10 - 1.11	6 (E63/E64)	01/04->07/07	1.45
A6 (4A, C4)	06/94->12/97	1.11 - 1.12	7 (E23)	05/77->08/86	1.46
A6 (4B, C5)	01/97->01/05	1.12 - 1.14	7 (E32)	09/86->09/94	1.46
A6 Allroad (4BH)	05/00->08/05	1.14	7 (E38)	10/94->11/01	1.47
A6 (4F2, 4F5)	05/04->10/08	1.14 - 1.15	7 (E65, E66)	11/01->03/05	1.47 - 1.48
A6 Allroad (4FH)	05/06->10/08	1.15 - 1.17	7 (F01, F02, F03, F04)	10/08->	1.48
A8 (4D2, 4D8)	01/99->	1.18	Chrysler		
A8 (4E_)	10/02->	1.18	PT Cruiser	06/00->	1.48
Convertible (B4)	05/91->08/00	1.18	Citroën		
Coupé (89, 8B)	10/88->12/96	1.19	Berlingo (MF, M_)	11/02->	1.49
Q7 (4L)	03/06->04/09	1.19	C2 (JM_)	09/03->12/09	1.49
TT (8N3, 8N9)	10/98->06/06	1.19	C3 (A51)	11/09->	1.49
80 (81, 85, B2)	08/78->08/86	1.19 - 1.20	C3 Picasso (A58)	02/09->	1.49
80 (89, 89Q, 8A, B3)	06/86->10/91	1.20 - 1.21	C4 (LC_)	11/04->	1.50
80 (8C, B4)	09/91->01/96	1.21	C4 Coupé (LA_)	11/04->08/08	1.50 - 1.51
90 (81, 85, B2)	10/84->03/87	1.21 - 1.22	C4 Picasso (UD_,JA_)	10/06->	1.51
90 (89, 89Q, 8A, B3)	04/87->09/91	1.22	DS3 (A55)	04/10->	1.52
100 (44, 44Q, C3)	08/82->11/90	1.22 - 1.23	Fiat		
100 (4A, C4)	12/90->07/94	1.23 - 1.25	Multipla (186)	04/99->09/04	1.52
200 (44, 44Q)	06/83->12/91	1.25	Punto (176)	09/93->09/99	1.52 - 1.53
BMW			Ford		
X3 (E83)	01/04->08/04	1.25 - 1.26	C-Max	02/07->	1.53
X5 (E53)	10/02->	1.26	Escort V, VI	07/90->01/95	1.53
X6 (E71, E72)	05/08->07/09	1.26	Escort VII	01/95->02/99	1.53 - 1.54
Z4 (E89)	05/09->	1.26	Fiesta III (GFJ)	01/89->12/95	1.54
3 (E30)	09/82->06/94	1.26 - 1.28	Fiesta V (JH_, JD_)	11/01->10/05	1.54 - 1.55
3 (E36)	09/90->08/00	1.28 - 1.29	Fiesta VI	10/08->	1.55
3 (E46) Sedan, Touring	02/98->	1.29 - 1.30	Focus	10/98->11/04	1.55 - 1.57
3 (E46) Convertible, Coupé	04/00->	1.30 - 1.31	Focus II	11/04->02/08	1.58 - 1.62



Manufacturer	Model year	Page	Manufacturer	Model year	Page
Ford			Mercedes-Benz		
Focus C-MAX	10/03->03/07	1.62	Vaneo (414)	02/02->	1.85
Fusion (JU_)	08/02->11/05	1.62 - 1.63	Viano (W 639)	09/10->	1.85
Galaxy (VX, VY)	03/95->05/06	1.63	190 (W 201)	10/82->08/93	1.86
Galaxy	05/06->	1.64	200 - 300 (W 123)	02/76->02/06	1.86 - 1.87
Kuga	03/08->	1.64	200 - 500 (W 124)	12/84->06/93	1.87 - 1.88
Maverick (UDS, UNS)	02/93->06/96	1.64	Nissan		
Mondeo II	01/98->11/00	1.64	Navara (D40)	04/10->	1.89
Mondeo III	11/00->03/07	1.65	Pathfinder (R51)	04/10->	1.89
Mondeo IV	03/07->10/10	1.66 - 1.67	Qashqai (J10, JJ10)	01/10->	1.89 - 1.90
S-MAX	05/06->	1.67	Terrano II (R20)	10/92->03/05	1.90
Hyundai			Opel		
i30, i30cw	04/09->	1.67	Astra F	09/91->01/98	1.90 - 1.91
KIA			Astra G	02/98->10/05	1.91 - 1.92
Cee'd	12/06->09/09	1.68	Astra H	03/04->02/07	1.92 - 1.94
Land Rover			Astra J	12/09->	1.94 - 1.95
Freelander II (FA_)	10/10->	1.68	Combo II	10/01->	1.95
Mercedes-Benz			Corsa C	10/00->	1.95
C-Class (W/S 202)	03/93->03/01	1.68 - 1.69	Insignia	07/08->	1.95 - 1.96
C-Class (W/S 203)	05/00->02/04	1.69 - 1.70	Kadett E	09/84->08/91	1.96
C-Class Sports Coupé (CL 203)	03/01->02/04	1.70	Omega A	09/86->05/94	1.96 - 1.97
CLK (C 208)	06/97->02/03	1.71	Omega B	03/94->07/03	1.97 - 1.98
CLK (C 209)	06/02->05/05	1.71	Signum	05/03->08/05	1.98 - 1.99
CLS (C 219)	10/04->	1.72	Vectra A	04/88->11/95	1.99
E-Class (W/S 124)	06/93->03/98	1.72 - 1.73	Vectra C	04/02->08/05	1.99 - 1.100
E-Class (W/S 210)	06/95->03/03	1.73 - 1.75	Zafira A (F75_)	04/99->06/05	1.100
E-Class (W/S 211)	03/02->06/06	1.75 - 1.79	Zafira B	07/05->	1.100
E-Class (W/S 212)	01/09->	1.79 - 1.80	Peugeot		
E-Class Coupé/Cabrio (C 207)	01/09->	1.80	107	06/05->	1.101
G-Class (W 460)	05/79->07/93	1.80 - 1.81	207	02/06->08/09	1.101 - 1.102
G-Class (W 461)	02/90->	1.81	Partner (5F, 5)	11/02->	1.102
G-Class (W 463)	09/89->	1.81	Puch		
GL-Class (X 164)	09/06->09/07	1.82	G-Class (W 460)	05/79->07/93	1.102 - 1.103
M-Class (W 163)	09/01->06/05	1.82	G-Class (W 461)	02/90->	1.103
M-Class (W 164)	10/08->	1.83	G-Class (W 463)	09/89->	1.103
R-Class (W 251, V251)	01/06->07/10	1.83	Renault		
S-Class Coupé (C 215)	03/99->03/06	1.84	Avantime (DE0)	09/01->05/03	1.103
SLK (R 170)	06/96->04/04	1.84	Clio II (B/C/B0/1_)	09/98->05/09	1.104
SLK (R 171)	03/04->04/08	1.84	Espace III (JE_)	11/96->10/02	1.105



List of Manufacturers/Page



Manufacturer	Model year	Page	Manufacturer	Model year	Page
Renault			Skoda		
Grand Scénic II	04/04->07/06	1.105 - 1.106	Felicia II (6U1/6U5)	01/98->06/01	1.124
Kangoo (KC0/1_)	03/98->01/08	1.106	Octavia (1U2/1U5)	09/96->	1.125 - 1.126
Laguna (B56_, 556_, K56_)	11/93->03/01	1.106 - 1.107	Octavia (1Z3/1Z5)	02/04->12/08	1.126 - 1.127
Laguna II (BG0/1_, KG0/1_)	03/01->	1.107	Roomster (5J)	03/10->	1.128 - 1.129
Mastermaxi (FH/HH/UH)	04/98->	1.107	Superb (3U4)	02/02->03/08	1.129
Mégane I	01/96->08/03	1.107	Superb (3T4, 3T5)	03/08->	1.130
Mégane II	09/03->	1.108	Yeti	05/09->	1.130
Safrane I (B54_)	04/92->07/96	1.108	Vauxhall		
Safrane II (B54_)	07/96->12/00	1.108	Astra Mk I	08/79->	1.130
Scénic I (JA0/1_)	09/99->08/03	1.108	Astra Mk II, Belmont	10/84->08/91	1.130
Scénic II (JM0/1_)	06/03->07/06	1.109 - 1.110	Astra Mk III (F)	09/91->	1.131
Twingo (C06_/S06_)	03/93->	1.110	Astra Mk IV (G)	02/98->	1.131 - 1.132
Twingo (CN0_)	03/07->	1.110	Astra Mk V (H)	03/04->02/07	1.132 - 1.134
Vel Satis (BJ0)	06/02->	1.110	Astra Mk VI (J)	12/09->	1.134 - 1.135
19 II	04/92->12/95	1.111	Carlton Mk I	11/82->09/86	1.135
Saab			Cavalier Mk I	81->84	1.135
900 I	08/86->06/94	1.111	Cavalier Mk II	10/88->09/95	1.135
Seat			Cavalier Mk III	10/00->	1.136
Alhambra (7V8, 7V9)	04/96->06/00	1.111 - 1.112	Corsa Mk II (B)	10/00->	1.136
Altea (5P1)	03/04->03/09	1.112	Corsavan Mk II (B)	10/00->	1.136
Altea XL (5P5)	10/06->03/09	1.112 - 1.113	Insignia	07/08->	1.136 - 1.137
Arosa (6H)	05/97->06/04	1.113	Nova	03/83->02/93	1.137
Cordoba I	02/93->06/99	1.113 - 1.114	Omega (B)	03/94->07/03	1.137 - 1.138
Cordoba II Hatchback	06/99->10/02	1.114	Signum	05/03->08/05	1.139
Cordoba II Vario (6K5)	06/99->12/02	1.114	Vectra Mk II	04/02->08/05	1.139 - 1.140
Cordoba III (6L2)	09/02->	1.114 - 1.115	Zafira Mk I (A)	04/99->06/05	1.140
Ibiza I (021A)	03/91->12/93	1.115	Zafira Mk II (B)	07/05->	1.140
Ibiza II (6K1)	03/93->08/99	1.115	Volkswagen		
Ibiza III (6K1)	08/99->02/02	1.115 - 1.116	Amarok	09/10->	1.140
Ibiza IV (6L1)	02/02->05/08	1.116	Bora (1J2, 1J6)	10/98->07/05	1.140 - 1.141
Leon (1M1)	11/99->06/06	1.117	Caddy I (14)	08/82->07/92	1.141 - 1.142
Leon (1P1)	05/05->	1.117 - 1.118	Caddy II (9KA9, 9K9B, 9U7)	11/95->12/00	1.142
Toledo I (1L)	05/91->03/99	1.118 - 1.120	Caddy III (2K_, 2CA, 2CH)	09/10->12/04	1.142 - 1.143
Toledo II (1M2)	04/99->05/06	1.120	Corrado (53I)	09/88->12/95	1.143
Toledo III (5P2)	10/04->	1.121	Eos (1F7)	05/06->10/10	1.144
Skoda			Fox (5Z1, 5Z3)	04/05->	1.144
Fabia (6Y)	08/99->	1.121 - 1.122	Golf I (17, 155)	07/74->08/93	1.145
Fabia II	03/10->	1.123 - 1.124	Golf II (19E, 1G1)	08/83->12/92	1.145 - 1.146
Felicia I	10/94->03/98	1.124	Golf III (1H1, 1H5, 1E7)	08/91->06/02	1.146 - 1.151
			Golf IV (1J1, 1J5)	08/97->06/06	1.151 - 1.154



List of Manufacturers/Page





**1**

Manufacturer	Model year	Page	Manufacturer	Model year	Page
Volkswagen			Volvo		
Golf V (1K1)	10/94->12/05	1.154 - 1.157	940 (944)	08/90->12/94	1.185
Golf V Estate (1K5)	06/07->07/09	1.158	960 (964)	08/90->07/94	1.186
Golf VI (5K1)	10/08->	1.158 - 1.159			
Golf VI Estate (AJ5)	07/09->	1.159 - 1.160			
Golf Plus (5M1, 521)	01/05->02/09	1.160 - 1.161			
Jetta I (17)	08/78->02/84	1.161			
Jetta II (19E, 1G2)	01/84->10/91	1.161 - 1.162			
Jetta III (1K2)	08/05->	1.162			
Lupo (6X1, 6E1)	09/98->07/05	1.162 - 1.163			
New Beetle (9C1, 1C1, 1Y7)	01/98->06/05	1.163			
Passat (3A2, 3A5, 35I)	02/88->05/97	1.163 - 1.165			
Passat (3B2, 3B5)	08/96->11/00	1.165 - 1.166			
Passat (3B3, 3B6)	11/00->08/05	1.167			
Passat (3C2, 3C5)	03/05->	1.167 - 1.168			
Polo II (86C, 80)	10/81->09/94	1.168 - 1.169			
Polo III (6N1)	10/94->10/99	1.169 - 1.171			
Polo III (6N2)	10/99->10/01	1.171 - 1.172			
Polo IV (9N_)	10/01->04/05	1.172			
Polo IV (9N2)	05/05->06/09	1.173			
Polo V (6R_)	06/09->	1.173			
Scirocco (53B)	06/81->07/82	1.173			
Scirocco (137)	09/08->	1.174			
Sharan (7M8, 7M9, 7M6)	09/95->	1.174 - 1.175			
Tiguan (5N_)	09/07->	1.175 - 1.176			
Touareg (7LA, 7L6, 7L7)	10/02->11/06	1.176			
Touran (1T1, 1T2, 1T3)	02/03->10/06	1.177 - 1.178			
Vento (1H2)	11/91->09/98	1.178 - 1.179			
Transporter (T2)	08/71->07/79	1.179			
Transporter (T3)	05/79->07/92	1.179			
Transporter (T4)	09/90->04/03	1.180 - 1.181			
Multivan (T5)	04/03->10/09	1.181 - 1.182			
Volvo					
C70	03/97->09/02	1.182			
S40 I (VS)	07/95->12/03	1.183			
S70	01/97->11/00	1.183 - 1.184			
S80	05/98->12/00	1.184			
V40 (VW)	07/95->06/04	1.184 - 1.185			
V70 I Estate	01/97->11/00	1.185			
XC 90	10/02->	1.185			
850 (LS, LW)	08/93->10/97	1.185			



Manufacturer Model	Model year	Part no.	Pk.	Note
Alfa Romeo				
145, 146 (930)		2BA 007 042-031	1	Indicator light (white), left
145 (930)	07/94->01/01	2BA 007 042-041	1	Indicator light (white), right
146 (930)	12/94->01/01	8GA 006 841-121	1	Accessories: 1x12V21W (PY21W)
Audi				
A1 (8X0)		2SK 010 436-091	1	Combination rearlight, left, with rear fog and reverse light, with bulbs
A1 (8X0)	05/10->	2SK 010 436-101	1	Combination rearlight, right, with rear fog and reverse light, with bulbs
(-) LED		8GA 002 073-121	1	Spare Parts: 3x12V21W (P21W)
		8GA 008 246-001	1	2x12V16W (W16W)
A1 (8X0)	05/10->	2SK 010 437-091	1	LED combination rearlight, left, with rear fog and reverse light, with bulbs
(+) LED		2SK 010 437-101	1	LED combination rearlight, right, with rear fog and reverse light, with bulbs
		8GA 008 246-001	1	Spare Parts: 2x12V16W (W16W)
A2 (8Z0)		6NM 007 878-041	1	Headlight levelling actuator
A2 (8Z0)	02/00->12/03			
A2 (8Z0)	02/00->08/05	9EL 270 107-011	1	Body/lens for auxiliary indicator light (white)
		8GP 003 594-121	1	Accessories: 1x12V5W (W5W)
A3 (8L1)		6NM 007 878-531	1	Headlight levelling actuator
A3 (8L1)	09/96->08/00			
(-) S3				







Manufacturer Model	Model year	Part no.	Pk.	Note
Audi				
A3 (8L1) A3 (8L1) (-) S3	09/96->08/00	9EL 963 111-011 9EL 963 112-011 8GA 006 841-121	1 1 1	Body/lens for indicator light (clear), left Body/lens for indicator light (clear), right Accessories: 1x12V21W (PY21W)
				
A3 (8L1)	09/00->05/03	1LL 008 306-151 1LL 008 306-161 6NM 007 878-541 8GH 002 089-133 8GH 007 157-121 8GP 003 594-121 8GA 006 841-121	1 1 1 1 1 1 1	DE®-H1/H7 headlight, left, with indicator light, without headlight levelling actuator, with bulbs DE®-H1/H7 headlight, right, with indicator light, without headlight levelling actuator, with bulbs Accessories: Headlight levelling actuator Spare Parts: 1x12V55W (H1) 1x12V55W (H7) 1x12V5W (W5W) 1x12V21W (PY21W)
				
A3 (8L1)	09/96->08/00	6NM 007 878-531	1	Headlight levelling actuator
				
A3 (8L1)	09/00->05/03	6NM 007 878-541	1	Headlight levelling actuator
				
A3 (8P1, 8PA) A3 (8P1) A3 Sportback (8PA) A3 Convertible	07/08-> 07/08-> 04/08->	1LJ 009 648-031 1LJ 009 648-041 8GH 007 157-121 8GP 003 594-121	1 1 1 1	FF®-H7 headlight, left, with indicator light, with daytime running light, with electric headlight levelling actuator, with bulbs FF®-H7 headlight, right, with indicator light, with daytime running light, with electric headlight levelling actuator, with bulbs Spare Parts: 2x12V55W (H7) 1x12V19W (P24W) 1x12V24W (PY24W) 1x12V5W (W5W)
				



Audi



Manufacturer Model	Model year	Part no.	Pk.	Note
Audi				
A3 (8P1, 8PA)		1N0 247 003-011	1	FF®-H7 fog light, left, with bulb
A3 (8P1)	05/03->06/08	1N0 247 003-021	1	FF®-H7 fog light, right, with bulb
A3 Sportback (8PA)	09/04->06/08			Spare Parts:
for PR no. 2JB, 2JW (standard bumper, not painted)		8GH 007 157-121	1	1x12V55W (H7)
				
A3 (8P1)	05/03->07/08	1N0 010 380-011	1	FF®-H11 fog light, left, with bulb
A3 Sportback (8PA)	09/04->07/08	1N0 010 380-021	1	FF®-H11 fog light, right, with bulb
for PR no. 2JD, 2JU, 2JY (standard bumper, Sport bumper)		8GH 008 358-121	1	Spare Parts: 1x12V55W (H11)
A3 (8P1), A3 Sportback (8PA)	08/08->			
A3 Convertible	04/08->			
				
A4 (8D2, 8D5, B5)		6NM 007 878-041	1	Headlight levelling actuator (for halogen headlight)
A4 (8D2, 8D5, B5)	01/99->09/01			
from chassis no. 8D-X-200 001				
				
A4 (8D2, 8D5, B5)	01/99->09/01	6NM 007 878-041	1	Headlight levelling actuator (for xenon headlight)
Chassis no. 8D-X-200 001 -> 8D-1-200 000				
				



Manufacturer Model	Model year	Part no.	Pk.	Note
Audi				
A4 (8D2, 8D5, B5) A4 (8D2, 8D5, B5) up to chassis no. 8D-X 199 999	01/95->12/98	9EL 158 254-011 9EL 158 254-021 8GA 006 841-121	1 1 1	Body/lens for indicator light (white), left Body/lens for indicator light (white), right Accessories: 1x12V21W (PY21W)
				
A4 (8D2, 8D5, B5) Chassis no. 8D-X 200 001 -> 8D-1-200 000	01/99->09/01	1N0 010 845-011 1N0 010 845-021 8GH 007 157-121	1 1 1	FF®-H7 fog light, left, with bulb FF®-H7 fog light, right, with bulb Spare Parts: 1x12V55W (H7)
				
A4 (8D2, 8D5, B5)	05/99->09/01	9EL 270 107-011 8GP 003 594-121	1 1	Body/lens for auxiliary indicator light (white) Accessories: 1x12V5W (W5W)
				
A4 (8E2, 8E5, B6) A4 (8E2, 8E5, B6) up to chassis no. 8E-5-400 000	11/00->12/04	6NM 007 878-041	1	Headlight levelling actuator (for halogen headlight)
				
A4 (8E2, 8E5, B6) (-) S4	11/00->12/04	1N0 009 594-011 1N0 009 594-021 8GH 008 358-121	1 1 1	FF®-H11 fog light, left, with bulb FF®-H11 fog light, right, with bulb Spare Parts: 1x12V55W (H11)
				
A4 (8E2, 8E5, B6) (-) Avant, S4	11/00->12/04	9EL 153 923-021 9EL 153 924-021 8GA 002 071-121 8GA 002 073-121 8GA 006 841-121 8GD 002 078-121	1 1 1 1 1 1	Body/lens for combination rearlight, left, with rear fog and reverse light Body/lens for combination rearlight, right, with rear fog and reverse light Accessories: 1x12V5W (R5W) 1x12V21W (P21W) 1x12V21W (PY21W) 1x12V21/5W (P21/5W)
				

**Audi**

Manufacturer Model	Model year	Part no.	Pk.	Note
Audi				
A4 (8EC, 8ED)		1N0 010 380-011	1	FF®-H11 fog light, left, with bulb
A4 (8EC, 8ED)	11/04->04/08	1N0 010 380-021	1	FF®-H11 fog light, right, with bulb
(-) RS4 from chassis no. 8E-5-400 001		8GH 008 358-121	1	Spare Parts: 1x12V55W (H11)
				
A4 RS4 (8EC, 8ED)	09/05->06/08	1N0 009 594-011	1	FF®-H11 fog light, left, with bulb
		1N0 009 594-021	1	FF®-H11 fog light, right, with bulb
		8GH 008 358-121	1	Spare Parts: 1x12V55W (H11)
				
A4 (8EC, 8ED)	11/04->11/07	2VP 965 037-051	1	Combination rearlight, left, outer part, with reverse light, with bulbs
(-) Avant for PR no. A8S, K8B		2VP 965 037-061	1	Combination rearlight, right, outer part, with reverse light, with bulbs
		8GA 002 073-121	1	Spare Parts: 4x12V21W (P21W)
				
A4 (8EC, 8ED)	11/04->11/07	2SA 965 038-031	1	Combination rearlight, left, inner part, with rear and rear fog light, with bulb
(-) Avant for PR no. A8S, K8B		2SA 965 038-041	1	Combination rearlight, right, inner part, with rear and rear fog light, with bulb
		8GA 002 073-121	1	Spare Parts: 2x12V21W (P21W)
				
A4 Convertible (8H7, 8HE)		1N0 010 380-011	1	FF®-H11 fog light, left, with bulb
A4 Convertible (8H7, 8HE)	01/06->	1N0 010 380-021	1	FF®-H11 fog light, right, with bulb
(-) RS4		8GH 008 358-121	1	Spare Parts: 1x12V55W (H11)
				



Manufacturer Model	Model year	Part no.	Pk.	Note
Audi				
A4 Convertible (8H7, 8HE) A4 Convertible RS4 (8H7, 8HE)	05/06->	1N0 009 594-011 1N0 009 594-021 8GH 008 358-121	1 1 1	FF®-H11 fog light, left, with bulb FF®-H11 fog light, right, with bulb Spare Parts: 1x12V55W (H11)
				
A6 (4A, C4) A6 (4A, C4)	06/94->12/97	9ES 145 599-001 9ES 145 600-001 8GH 002 089-133 8GH 002 090-133 8GP 003 594-121	1 1 1 1 1	DE®-H1 headlight, with DE®-H3 fog light, only spare parts available Spare Parts: Lens, left Lens, right 2x12V55W (H1) 1x12V55W (H3) 1x12V5W (W5W)
				
A6 (4A, C4)	06/94->12/97	6NM 007 282-211	1	Headlight levelling actuator
				
A6 (4A, C4)	06/94->12/97	9EL 145 833-021 9EL 145 834-021 8GA 006 841-121	1 1 1	Body/lens for indicator light (white), left Body/lens for indicator light (white), right Accessories: 1x12V21W (PY21W)
				
A6 (4A, C4)	06/94->12/97	2BM 003 647-021 8GP 003 594-121	1 1	Auxiliary indicator light (amber) Accessories: 1x12V5W (W5W)
				
A6 (4A, C4) (-) Avant	06/94->10/97	9EL 138 567-061 9EL 138 568-061 8GD 002 078-121 8GA 002 073-121	1 1 1 1	Body/lens for combination rearlight, left, outer part Body/lens for combination rearlight, right, outer part Accessories: 1x12V21/5W (P21/5W) 1x12V21W (P21W)
				



Audi







Manufacturer Model	Model year	Part no.	Pk.	Note
Audi				
A6 (4A, C4) A6 (4A, C4) Avant	06/94->12/97	9EL 140 063-021 9EL 140 064-021 8GD 002 078-121 8GA 002 073-121	1 1 1 1	Body/lens for combination rearlight, left, outer part Body/lens for combination rearlight, right, outer part Accessories: 1x12V21/5W (P21/5W) 1x12V21W (P21W)
				
A6 (4A, C4) (-) S6 A6 (4A, C4) Avant (-) S6	06/94->10/97 06/94->12/97	9EL 145 997-021 9EL 145 998-021 8GA 002 073-121	1 1 1	Body/lens for combination rearlight, left, inner part, with rear fog and reverse light Body/lens for combination rearlight, right, inner part, with rear fog and reverse light Accessories: 2x12V21W (P21W)
				
A6 (4B, C5) A6 (4B, C5) (-) 8 cyl.	01/97->08/99	1LL 007 821-291 1LL 007 821-301 6NM 007 878-531 8GH 002 089-133 8GH 007 157-121 8GP 003 594-121 8GA 006 841-121	1 1 1 1 1 1 1	DE@-H1/FF@-H7 headlight, left, with indicator light DE@-H1/FF@-H7 headlight, right, with indicator light Accessories: Headlight levelling actuator Spare Parts: 1x12V55W (H1) 1x12V55W (H7) 1x12V5W (W5W) 1x12V21W (PY21W)
				
A6 (4B, C5) (-) 8 cyl. (-) Allroad	01/97->05/01	6NM 007 878-531	1	Headlight levelling actuator
				
A6 (4B, C5) (-) Allroad	05/01->05/03	6NM 007 878-521	1	Headlight levelling actuator (for halogen headlight)
				



Manufacturer Model	Model year	Part no.	Pk.	Note
Audi				
A6 (4B, C5)		1NL 007 906-031	1	DE®-H3 fog light, left
A6 (4B, C5)	01/97->08/99	1NL 007 906-041	1	DE®-H3 fog light, right
(-) 8 cyl.		8GH 002 090-133	1	Accessories: 1x12V55W (H3)
A6 8 cyl.	11/98->01/05			
				
A6 (4B, C5)	06/01->01/05	1N0 246 039-011	1	FF®-H7 fog light, left, with bulb
(-) 8 cyl.		1N0 246 039-021	1	FF®-H7 fog light, right, with bulb
		8GH 007 157-121	1	Spare Parts: 1x12V55W (H7)
				
A6 (4B, C5)	01/99->01/05	9EL 270 107-011	1	Body/lens for auxiliary indicator light (white)
		8GP 003 594-121	1	Accessories: 1x12V5W (W5W)
				
A6 (4B, C5)	01/97->05/01	9EL 148 141-021	1	Body/lens for combination rearlight (grey/red), left, with reverse light
(-) Avant		9EL 148 142-021	1	Body/lens for combination rearlight (grey/red), right, with reverse light
		8GD 002 078-121	1	Accessories: 1x12V21/5W (P21/5W)
		8GA 002 073-121	1	2x12V21W (P21W)
				
A6 (4B, C5)	06/01->01/05	2VP 008 468-051	1	Combination rearlight, left, with reverse light, with bulbs
(-) Avant		2VP 008 468-061	1	Combination rearlight, right, with reverse light, with bulbs
		8GD 002 078-121	1	Spare Parts: 1x12V21/5W (P21/5W)
		8GA 002 073-121	1	2x12V21W (P21W)
				
A6 (4B, C5)	01/97->01/05	9EL 007 727-801	1	Design combination rearlight set (black) without bulb holder
(-) Avant		8RA 004 412-041	10	Spare Parts: Reflex-reflector (red)
		8GD 002 078-121	1	Accessories: 2x12V21/5W (P21/5W)
		8GA 002 073-121	1	4x12V21W (P21W)
		 Design		

**Audi**

Manufacturer Model	Model year	Part no.	Pk.	Note
Audi				
A6 (4B, C5) A6 (4B, C5) (-) Avant	01/97->01/05	9EL 007 727-811 8RA 004 412-041 8GD 002 078-121 8GA 002 073-121	1 10 1 1	Design combination rearlight set (brilliant silver) without bulb holder Spare Parts: Reflex-reflector (red) Accessories: 2x12V21/5W (P21/5W) 4x12V21W (P21W)
				
A6 Allroad (4BH) A6 Allroad (4BH)	05/00->08/05	9EL 270 107-011 8GP 003 594-121	1 1	Body/lens for auxiliary indicator light (white) Accessories: 1x12V5W (W5W)
				
A6 (4F2, 4F5) A6 (4F2, 4F5) (-) S6, RS6	05/04->10/08	1LE 008 880-031 1LE 008 880-041 8GH 007 157-121 8GH 002 089-133 8GA 006 841-121 8GP 003 594-121	1 1 1 1 1 1	FF®-H7/H1 headlight, left, with indicator light, with electric headlight levelling actuator, with bulbs FF®-H7/H1 headlight, right, with indicator light, with electric headlight levelling actuator, with bulbs Spare Parts: 2x12V55W (H7) 1x12V55W (H1) 1x12V21W (PY21W) 1x12V5W (W5W)
				
A6 (4F2, 4F5) (-) S6, RS6 (+) Bi-Xenon light (-) bend lighting	05/04->10/08	1LL 008 881-431 1LL 008 881-441 5DV 008 290-004 8GS 007 949-101 8GA 002 073-121 8GA 006 841-121 8GP 003 594-121	1 1 1 1 1 1 1	Bi-Xenon® headlight, left, with indicator light, with daytime running light, with headlight levelling actuator, without xenon ballast, without gas discharge bulb, with bulbs Bi-Xenon® headlight, right, with indicator light, with daytime running light, with headlight levelling actuator, without xenon ballast, without gas discharge bulb, with bulbs Accessories: Ballast unit Spare Parts: 1x35W (D2S) 1x12V21W (P21W) 1x12V21W (PY21W) 1x12V5W (W5W)
				
A6 (4F2, 4F5) (-) S6, RS6 for PR no. 8BD, AV0	10/08->	1LJ 009 925-031 1LJ 009 925-041 8GH 007 157-201 8GJ 168 119-001 8GA 006 841-121 8GP 003 594-121	1 1 1 1 1 1 1	FF®-H7/H15 headlight, left, with indicator light, with daytime running light, with electric headlight levelling actuator, with bulbs FF®-H7/H15 headlight, right, with indicator light, with daytime running light, with electric headlight levelling actuator, with bulbs Spare Parts: 1x12V55W (H7) Long Life 1x12V55/15W (H15) 1x12V21W (PY21W) 1x12V5W (W5W)
				



Manufacturer Model	Model year	Part no.	Pk.	Note
Audi				
A6 (4F2, 4F5) A6 (4F2, 4F5)	05/04->10/08	5DV 008 290-004	1	Ballast unit
				
A6 (4F2, 4F5)	05/04->10/08	5DD 008 319-501	1	Ignitor, gas discharge bulb
				
A6 (4F2, 4F5)	05/04->10/08	1N0 354 013-011 1N0 354 013-021	1 1	H7 fog light, left H7 fog light, right
		8GH 007 157-121	1	Accessories: 1x12V55W (H7)
A6 (4F5) Avant for PR no. 8TF, K8D, 8SK (+) LED	03/05->10/08	2VA 354 542-011 2VA 354 542-021	1 1	LED combination rearlight, left, outer part, with bulbs LED combination rearlight, right, outer part, with bulbs
		8GA 006 841-121	1	Spare Parts: 2x12V21W (PY21W)
A6 (4F5) Avant for PR no. 8TF, K8D, 8SK (+) LED	03/05->10/08	2NE 354 542-031 2NE 354 542-041	1 1	LED combination rearlight, left, inner part, with rear fog and reverse light, with bulbs LED combination rearlight, right, inner part, with rear fog and reverse light, with bulbs
		8GA 008 246-001	1	Spare Parts: 2x12V16W (W16W) 1x12V21W (H21W) Long Life
A6 Allroad (4FH) A6 Allroad (4FH)	05/06->10/08	1LE 008 880-031 1LE 008 880-041	1 1	H1/H7 headlight, left, with indicator light, with electric headlight levelling actuator, with bulbs H1/H7 headlight, right, with indicator light, with electric headlight levelling actuator, with bulbs
		8GH 007 157-121 8GH 002 089-133 8GA 006 841-121 8GP 003 594-121	1 1 1 1	Spare Parts: 2x12V55W (H7) 1x12V55W (H1) 1x12V21W (PY21W) 1x12V5W (W5W)





Audi



Manufacturer Model	Model year	Part no.	Pk.	Note
Audi				
A6 Allroad (4FH) A6 Allroad (4FH) (+) Bi-Xenon light (-) bend lighting	05/06->10/08	 1LL 008 881-431 1LL 008 881-441 5DV 008 290-004 8GS 007 949-101 8GA 002 073-121 8GA 006 841-121 8GP 003 594-121	1 1 1 1 1 1 1 1	Bi-Xenon® headlight, left, with indicator light, with daytime running light, with headlight levelling actuator, without xenon ballast, without gas discharge bulb, with bulbs Bi-Xenon® headlight, right, with indicator light, with daytime running light, with headlight levelling actuator, without xenon ballast, without gas discharge bulb, with bulbs Accessories: Ballast unit Spare Parts: 1x35W (D2S) 1x12V21W (P21W) 1x12V21W (PY21W) 1x12V5W (W5W)
A6 Allroad (4FH) for PR no. 8BD, AV0	10/08->	 1LJ 009 925-031 1LJ 009 925-041 8GH 007 157-201 8GJ 168 119-001 8GA 006 841-121 8GP 003 594-121	1 1 1 1 1 1 1	FF®-H7/H15 headlight, left, with indicator light, with daytime running light, with electric headlight levelling actuator, with bulbs FF®-H7/H15 headlight, right, with indicator light, with daytime running light, with electric headlight levelling actuator, with bulbs Spare Parts: 1x12V55W (H7) Long Life 1x12V55/15W (H15) 1x12V21W (PY21W) 1x12V5W (W5W)
A6 Allroad (4FH)	05/06->10/08	 5DV 008 290-004	1	Ballast unit
A6 Allroad (4FH)	05/06->10/08	 5DD 008 319-501	1	Ignitor, gas discharge bulb
A6 Allroad (4FH)	05/06->10/08	 1N0 354 013-011 1N0 354 013-021 8GH 007 157-121	1 1 1	H7 fog light, left H7 fog light, right Accessories: 1x12V55W (H7)



Manufacturer Model	Model year	Part no.	Pk.	Note
Audi				
A6 Allroad (4FH)	05/06->10/08	2VA 354 542-011	1	LED combination rearlight, left, outer part, with bulbs
A6 Allroad (4FH)	05/06->10/08	2VA 354 542-021	1	LED combination rearlight, right, outer part, with bulbs
for PR no. 8TF, K8D, 8SK		8GA 006 841-121	1	Spare Parts: 2x12V21W (PY21W)
(+ LED)				
A6 Allroad (4FH)	05/06->10/08	2NE 354 542-031	1	LED combination rearlight, left, inner part, with rear fog and reverse light, with bulbs
for PR no. 8TF, K8D, 8SK		2NE 354 542-041	1	LED combination rearlight, right, inner part, with rear fog and reverse light, with bulbs
(+ LED)		8GA 008 246-001	1	Spare Parts: 2x12V16W (W16W) 1x12V21W (H21W) Long Life



Audi



Manufacturer Model	Model year	Part no.	Pk.	Note
Audi				
A8 (4D2, 4D8) A8 (4D2, 4D8) from chassis no. 4D-1-000 001	01/99->12/02	1N0 010 845-011 1N0 010 845-021 8GH 007 157-121	1 1 1	FF®-H7 fog light, left, with bulb FF®-H7 fog light, right, with bulb Spare Parts: 1x12V55W (H7)
				
A8 (4D2, 4D8)	01/99->	9EL 270 107-011 8GP 003 594-121	1 1	Body/lens for auxiliary indicator light (white) Accessories: 1x12V5W (W5W)
				
A8 (4E_) A8 (4E_)	10/02->07/10	5DV 008 290-004	1	Ballast unit
				
A8 (4E_)	10/02->07/10	5DD 008 319-501	1	Ignitor, gas discharge bulb
				
S8	06/06->07/10	1N0 354 013-011 1N0 354 013-021 8GH 007 157-121	1 1 1	H7 fog light, left H7 fog light, right Accessories: 1x12V55W (H7)
				
Convertible (B4) Convertible (B4)	05/91->01/98	1NL 005 150-111 1NL 005 150-121 8GH 002 090-133	1 1 1	DE®-H3 fog light, left DE®-H3 fog light, right Accessories: 1x12V55W (H3)
				
Convertible (B4) all models with auxiliary indicators as standard feature	05/91->08/00	2BM 003 647-021 8GP 003 594-121	1 1	Auxiliary indicator light (amber) Accessories: 1x12V5W (W5W)
				









Manufacturer Model	Model year	Part no.	Pk.	Note
Audi				
Coupé (89, 8B) Coupé (89, 8B)	10/88->08/91	1NL 005 150-051 1NL 005 150-061 8GH 002 090-133	1 1 1	DE®-H3 fog light, left DE®-H3 fog light, right Accessories: 1x12V55W (H3)
Coupé (89, 8B)	09/91->12/96	1NL 005 150-111 1NL 005 150-121 8GH 002 090-133	1 1 1	DE®-H3 fog light, left DE®-H3 fog light, right Accessories: 1x12V55W (H3)
Q7 (4L) Q7 (4L)	03/06->04/09	6NM 007 878-041	1	Headlight levelling actuator (for halogen headlight)
Q7 (4L) (-) 12 cyl.	03/06->04/09	1N0 247 003-011 1N0 247 003-021 8GH 007 157-121	1 1 1	FF®-H7 fog light, left, with bulb FF®-H7 fog light, right, with bulb Spare Parts: 1x12V55W (H7)
TT (8N3, 8N9) TT (8N3) TT Roadster (8N9)	10/98->06/06 10/99->06/06	9EL 270 107-011 8GP 003 594-121	1 1	Body/lens for auxiliary indicator light (white) Accessories: 1x12V5W (W5W)
80 (81, 85, B2) 80 (81, 85, B2)	08/84->08/86	9EL 129 161-011 9EL 129 162-011 8GA 002 073-121	1 1 1	Body/lens for indicator light, left Body/lens for indicator light, right Accessories: 1x12V21W (P21W)
80 (81, 85, B2) all models with auxiliary indicators as standard feature	08/84->08/86	2BM 003 647-021 8GP 003 594-121	1 1	Auxiliary indicator light (amber) Accessories: 1x12V5W (W5W)



Audi



Manufacturer Model	Model year	Part no.	Pk.	Note
Audi				
80 (81, 85, B2)		9EL 129 149-021	1	Body/lens for combination rearlight, left, outer part
80 (81, 85, B2)	08/84->08/86	9EL 129 150-021	1	Body/lens for combination rearlight, right, outer part
		8GA 002 071-131	1	Accessories: 1x12V10W (R10W)
		8GD 002 078-121	1	1x12V21/5W (P21/5W)
		8GA 002 073-121	1	1x12V21W (P21W)
80 (81, 85, B2)	08/78->08/86	2JA 002 931-031	5	Interior light
		8GM 002 091-131	1	Accessories: 1x12V10W (K)
80 (89, 89Q, 8A, B3)		9EL 135 007-001	1	Body/lens for indicator light (amber), left
80 (89, 89Q, 8A, B3)	06/86->10/91	9EL 135 008-001	1	Body/lens for indicator light (amber), right
		8GA 002 073-121	1	Accessories: 1x12V21W (P21W)
80 (89, 89Q, 8A, B3)	06/86->10/91	2BA 005 296-031	1	Indicator light (white), left, with bulb
		2BA 005 296-041	1	Indicator light (white), right, with bulb
		8GA 006 841-121	1	Spare Parts: 1x12V21W (PY21W)
80 (89, 89Q, 8A, B3)	06/86->10/91	2BM 003 647-021	1	Auxiliary indicator light (amber)
all models with auxiliary indicators as standard feature		8GP 003 594-121	1	Accessories: 1x12V5W (W5W)
80 (89, 89Q, 8A, B3)	06/86->10/91	9EL 131 651-031	1	Body/lens for combination rearlight, left, outer part
		9EL 131 652-031	1	Body/lens for combination rearlight, right, outer part
		8GA 002 071-131	1	Accessories: 1x12V10W (R10W)
		8GD 002 078-121	1	1x12V21/5W (P21/5W)
		8GA 002 073-121	1	1x12V21W (P21W)



Manufacturer Model	Model year	Part no.	Pk.	Note
Audi				
80 (89, 89Q, 8A, B3) 80 (89, 89Q, 8A, B3)	06/86->10/91		9EM 131 613-021 1 9EM 131 614-021 1 9EL 131 613-031 1 9EL 131 614-031 1 8GA 002 073-121 1	Body/lens for combination rearlight, left, inner part, with rear fog and reverse light Body/lens for combination rearlight, right, inner part, with rear fog and reverse light Body/lens for combination rearlight, left, inner part, with reverse light Body/lens for combination rearlight, right, inner part, with reverse light Accessories: 2x12V21W (P21W)
80 (8C, B4) 80 (8C, B4)	09/91->01/96		1NL 005 150-111 1 1NL 005 150-121 1 8GH 002 090-133 1	DE®-H3 fog light, left DE®-H3 fog light, right Accessories: 1x12V55W (H3)
80 (8C, B4) 4/5 cyl.	09/91->01/96		9EL 141 605-011 1 9EL 141 606-011 1 8GA 006 841-121 1	Body/lens for indicator light (white), left Body/lens for indicator light (white), right Accessories: 1x12V21W (PY21W)
80 (8C, B4) all models with auxiliary indicators as standard feature	09/91->01/96		2BM 003 647-021 1 8GP 003 594-121 1	Auxiliary indicator light (amber) Accessories: 1x12V5W (W5W)
80 (8C, B4) (-) Avant	09/91->12/94		9EL 140 347-021 1 9EL 140 348-021 1 8GD 002 078-121 1 8GA 002 073-121 1	Body/lens for combination rearlight, left, outer part Body/lens for combination rearlight, right, outer part Accessories: 1x12V21/5W (P21/5W) 1x12V21W (P21W)
90 (81, 85, B2) 90 (81, 85, B2) all models with auxiliary indicators as standard feature	10/84->03/87		2BM 003 647-021 1 8GP 003 594-121 1	Auxiliary indicator light (amber) Accessories: 1x12V5W (W5W)









Audi



Manufacturer Model	Model year	Part no.	Pk.	Note
Audi				
90 (81, 85, B2)		9EL 129 149-021	1	Body/lens for combination rearlight, left, outer part
90 (81, 85, B2)	10/84->03/87	9EL 129 150-021	1	Body/lens for combination rearlight, right, outer part
		8GA 002 071-131	1	Accessories: 1x12V10W (R10W)
		8GD 002 078-121	1	1x12V21/5W (P21/5W)
		8GA 002 073-121	1	1x12V21W (P21W)
90 (81, 85, B2)	10/84->03/87	2JA 002 931-031	5	Interior light
		8GM 002 091-131	1	Accessories: 1x12V10W (K)
90 (89, 89Q, 8A, B3)		1NL 005 150-051	1	DE®-H3 fog light, left
90 (89, 89Q, 8A, B3)	04/87->09/91	1NL 005 150-061	1	DE®-H3 fog light, right
		8GH 002 090-133	1	Accessories: 1x12V55W (H3)
90 (89, 89Q, 8A, B3)	04/87->09/91	2BM 003 647-021	1	Auxiliary indicator light (amber)
all models with auxiliary indicators as standard feature		8GP 003 594-121	1	Accessories: 1x12V5W (W5W)
90 (89, 89Q, 8A, B3)	04/87->09/91	9EL 131 651-031	1	Body/lens for combination rearlight, left, outer part
		9EL 131 652-031	1	Body/lens for combination rearlight, right, outer part
		8GA 002 071-131	1	Accessories: 1x12V10W (R10W)
		8GD 002 078-121	1	1x12V21/5W (P21/5W)
		8GA 002 073-121	1	1x12V21W (P21W)
90 (89, 89Q, 8A, B3)	04/87->09/91	2NR 005 190-071	1	Body/lens with rear panel, with rear fog and reverse light left and right
	 Design	8GA 002 073-121	1	Accessories: 3x12V21W (P21W)
		8GA 002 073-121	1	Spare Parts: 1x12V21W (P21W)
100 (44, 44Q, C3)		2BM 003 647-021	1	Auxiliary indicator light (amber)
100 (44, 44Q, C3)	08/82->11/90	8GP 003 594-121	1	Accessories: 1x12V5W (W5W)
all models with auxiliary indicators as standard feature				



Manufacturer Model	Model year	Part no.	Pk.	Note
Audi				
100 (44, 44Q, C3) 100 (44, 44Q, C3) (-) Avant	08/82->11/90	 9EL 126 339-021 9EL 126 340-021 8GA 002 071-131 8GD 002 078-121 8GA 002 073-121	1 1 1 1 1	Body/lens for combination rearlight, left, outer part Body/lens for combination rearlight, right, outer part Accessories: 1x12V10W (R10W) 1x12V21/5W (P21/5W) 1x12V21W (P21W)
100 (4A, C4) 100 (4A, C4) (-) S4, TDI	12/90->07/94	 9ES 137 170-015 8GJ 002 525-131 8GP 002 067-121	3 1 1	H4 headlight, only spare parts available Spare Parts: Lens, right 1x12V60/55W (H4) 1x12V4W (T4W)
100 (4A, C4)	12/90->06/94	 6NM 007 282-211	1	Headlight levelling actuator
100 (4A, C4) (-) S4, TDI	12/90->06/94	 1NL 006 150-071 1NL 006 150-081 8GH 002 090-133	1 1 1	DE®-H3 fog light, left, with bulb DE®-H3 fog light, right, with bulb Spare Parts: 1x12V55W (H3)
100 (4A, C4) (-) S4, TDI	12/90->06/94	 9EL 139 383-031 9EL 139 384-031 8GA 002 073-121	1 1 1	Body/lens for indicator light (amber), left Body/lens for indicator light (amber), right Accessories: 1x12V21W (P21W)
100 (4A, C4) (-) S4, TDI	12/90->06/94	 2BA 006 386-071 2BA 006 386-081 8GA 006 841-121	1 1 1	Indicator light (white), left, with bulb, for conversion Indicator light (white), right, with bulb, for conversion Spare Parts: 1x12V21W (PY21W)



Audi



Manufacturer Model	Model year	Part no.	Pk.	Note
Audi				
100 (4A, C4) 100 (4A, C4) S4, TDI	09/91->06/94	 2BA 006 386-071 2BA 006 386-081 8GA 006 841-121	1 1 1	Indicator light (white), left, with bulb Indicator light (white), right, with bulb Spare Parts: 1x12V21W (PY21W)
100 (4A, C4) all models with auxiliary indicators as standard feature	12/90->06/94	 2BM 003 647-021 8GP 003 594-121	1 1	Auxiliary indicator light (amber) Accessories: 1x12V5W (W5W)
100 (4A, C4) (-) Avant, S4	12/90->06/94	 9EL 138 567-031 9EL 138 568-031 8GD 002 078-121 8GA 002 073-121	1 1 1 1	Body/lens for combination rearlight, left, outer part Body/lens for combination rearlight, right, outer part Accessories: 1x12V21/5W (P21/5W) 1x12V21W (P21W)
100 (4A, C4) (-) Avant, S4	12/90->06/94	 9EL 138 567-061 9EL 138 568-061 8GD 002 078-121 8GA 002 073-121	1 1 1 1	Body/lens for combination rearlight, left, outer part (red), for conversion Body/lens for combination rearlight, right, outer part (red), for conversion Accessories: 1x12V21/5W (P21/5W) 1x12V21W (P21W)
100 (4A, C4) S4 (-) Avant	09/91->06/94	 9EL 138 567-061 9EL 138 568-061 8GD 002 078-121 8GA 002 073-121	1 1 1 1	Body/lens for combination rearlight, left, outer part (red) Body/lens for combination rearlight, right, outer part (red) Accessories: 1x12V21/5W (P21/5W) 1x12V21W (P21W)



Manufacturer Model	Model year	Part no.	Pk.	Note
Audi				
100 (4A, C4) 100 (4A, C4) Avant	09/91->06/94	9EL 140 063-021 9EL 140 064-021 8GD 002 078-121 8GA 002 073-121	1 1 1 1	Body/lens for combination rearlight, left, outer part Body/lens for combination rearlight, right, outer part Accessories: 1x12V21/5W (P21/5W) 1x12V21W (P21W)
100 (4A, C4), Avant (-) S4	09/91->06/94	9EL 138 463-031 9EL 138 464-031 8GA 002 073-121	1 1 1	Body/lens for combination rearlight, left, inner part, with rear fog and reverse light Body/lens for combination rearlight, right, inner part, with rear fog and reverse light Accessories: 2x12V21W (P21W)
200 (44, 44Q) 200 (44, 44Q) all models with auxiliary indicators as standard feature	06/83->12/91	2BM 003 647-021 8GP 003 594-121	1 1	Auxiliary indicator light (amber) Accessories: 1x12V5W (W5W)
200 (44, 44Q)	06/83->12/91	9EL 126 339-021 9EL 126 340-021 8GA 002 071-131 8GD 002 078-121 8GA 002 073-121	1 1 1 1 1	Body/lens for combination rearlight, left Body/lens for combination rearlight, right Accessories: 1x12V10W (R10W) 1x12V21/5W (P21/5W) 1x12V21W (P21W)
BMW				
X3 (E83) X3 (E83) (+) Aerodynamic package (+) M aerodynamic package	01/04->08/04	1N0 010 501-001 8GH 008 358-121	1 1	H11 fog light, left and right, with bulb Spare Parts: 1x12V55W (H11)

**BMW**

Manufacturer Model	Model year	Part no.	Pk.	Note
BMW				
X3 (E83) X3 (E83) (+) Aerodynamic package (+) M aerodynamic package	01/04->	1N0 010 345-011 1N0 010 345-021 8GH 005 636-121	1 1 1	HB4 fog light, left, with bulb HB4 fog light, right, with bulb Spare Parts: 1x12V51W (HB4)
				
X5 (E53) X5 (E53)	10/02->	1N0 010 843-011 1N0 010 843-021 8GH 008 358-121	1 1 1	FF®-H11 fog light, left, with bulb FF®-H11 fog light, right, with bulb Spare Parts: 1x12V55W (H11)
				
X6 (E71, E72) X6 (E71, E72)	05/08->07/09	5DV 009 000-001	1	Ballast unit
				
Z4 (E89) Z4 (E89)	05/09->	1LL 009 933-431 1LL 009 933-441 8GS 009 028-201 8GH 008 356-121	1 1 1 1	Bi-Xenon®/H8 headlight, left, with indicator light, with daytime running light, with electric headlight levelling actuator, without xenon ballast, without gas discharge bulb, with bulbs Bi-Xenon®/H8 headlight, right, with indicator light, with daytime running light, with electric headlight levelling actuator, without xenon ballast, without gas discharge bulb, with bulbs Spare Parts: 1x35W (D3S) 1x12V35W (H8) 1x12V24W (PY24W)
				
3 (E30) 3 (E30) 316, 318i, 320i, 323i, 324d, 325e, 325i 325i Convertible	09/82->08/87 09/82->08/87 04/86->08/87	1K3 126 046-001 1K3 126 680-001 9AG 126 547-005 8GH 002 089-133 8GP 002 067-121	1 1 12 1 1	H1 headlight, only spare parts available Spare Parts: Main-beam unit, left Main-beam unit, right Lens-retaining rim 1x12V55W (H1) 1x12V4W (T4W)
				



Manufacturer Model	Model year	Part no.	Pk.	Note
BMW				
3 (E30)				DE®-H1 headlight, not suitable for headlight leveller, only spare parts available
3 (E30)	09/87->08/88			
M3, 316i, 318i, 320i, 324d, 324td, 325i Sedan, Convertible	09/87->08/88	1K3 134 855-011 1K3 134 856-011	1 1	Spare Parts: Main-beam unit, left Main-beam unit, right
Touring	04/88->08/88	8GH 002 089-133 8GP 003 594-121	1 1	Accessories: 2x12V55W (H1) 1x12V5W (W5W)
3 (E30)	09/88->06/94	1DL 005 930-371	1	Super DE®-H1 headlight, left, for vehicles with or without headlight leveller
M3, 316i, 318i, 320i, 324d, 324td, 325i, 325iX Sedan	09/88->01/92	1DL 005 930-381	1	Super DE®-H1 headlight, right, for vehicles with or without headlight leveller
Convertible	09/88->10/93	9BG 135 941-011 9BG 135 942-011 9DR 136 958-021	1 1 1	Spare Parts: Body with lens for dipped-beam, left Body with lens for dipped-beam, right Reflector with lens (module) for dipped-beam light
Touring	09/88->06/94	1K3 134 855-011 1K3 134 856-011	1 1	Main-beam unit, left Main-beam unit, right
3 (E30)	09/82->08/87	1NB 123 581-001 1NB 123 582-001	1 1	H3 fog light unit, left H3 fog light unit, right
3 (E30)	09/82->08/87	9EL 146 607-001	5	Lens for indicator light
3 (E30)	09/87->06/94	2BA 007 275-011 2BA 007 275-021	1 1	Indicator light (amber), left Indicator light (amber), right
(-) M3		8GA 002 073-121	1	Accessories: 1x12V21W (P21W)
3 (E30)	09/82->06/94	2BM 003 933-031 2BM 003 933-041	1 1	Auxiliary indicator light, left Auxiliary indicator light, right
3 (E30)	09/82->06/94	2KA 004 331-031	4	Licence plate light
		8GM 002 092-121	1	Accessories: 1x12V5W (C5W)



**BMW**

Manufacturer Model	Model year	Part no.	Pk.	Note
BMW				
3 (E30) 3 (E30) Sedan, Touring	09/82->06/94	2JA 003 388-001 8GM 002 091-131	1 1	Interior light Accessories: 1x12V10W (K)
				
3 (E36) 3 (E36) Compact 316i, 318ti, 318tds, 323ti Compact	03/94->08/00 03/94->08/00	1LJ 007 143-051 1LJ 007 143-061 6NM 004 375-311 9ES 145 251-005 9ES 145 252-005 9GD 142 757-031 8GH 005 636-121 8GH 005 635-121 8GP 003 594-121	1 1 1 4 4 4 1 1 1	FF®-HB3/HB4 fog light, left, with electric headlight leveller, with bulbs FF®-HB3/HB4 fog light, right, with electric headlight leveller, with bulbs Accessories: Headlight levelling actuator Spare Parts: 4 Cover lens, left (without optical pattern) 4 Cover lens, right (without optical pattern) 4 Seal 1 1x12V51W (HB4) 1 1x12V60W (HB3) 1 1x12V5W (W5W)
				
3 (E36) M3, 316i, 318i, 318is, 318tds, 320i, 323i 2.5, 325i, 325td, 325tds, 328i Sedan Coupé Convertible Compact Touring	09/90->08/00 09/90->02/98 03/92->04/99 03/93->04/99 03/94->08/00 01/95->10/99	1LL 008 875-811 8GH 007 157-121	1 1	DE®-H7/FF®-H7 headlight set (Upgrade) bright-metallized, with CELIS® position lights, with bulbs Spare Parts: 4x12V55W (H7)
	 Design			
3 (E36) Sedan Coupé Convertible Compact Touring	09/90->08/00 09/90->02/98 03/92->04/99 03/93->04/99 03/94->08/00 01/95->10/99	6NM 004 375-311	1	Headlight levelling actuator
				



Manufacturer Model	Model year	Part no.	Pk.	Note
BMW				
3 (E36)		1NB 006 270-051	1	FF®-H1 fog light, left
3 (E36)	09/90->08/00	1NB 006 270-061	1	FF®-H1 fog light, right
Sedan	09/90->02/98	8GH 002 089-133	1	Accessories: 1x12V55W (H1)
Coupé	03/92->04/99			
Convertible	03/93->04/99			
Compact	03/94->08/00			
Touring	01/95->10/99			
				
3 (E46) Sedan, Touring		1ND 007 646-011	1	FF®-HB4 fog light, left, with bulb
3 (E46) Sedan	02/98->09/01	1ND 007 646-021	1	FF®-HB4 fog light, right, with bulb
Touring	10/99->09/01	8GH 005 636-121	1	Spare Parts: 1x12V51W (HB4)
(-) M3				
				
3 (E46) Saloon, Touring	09/01->	1NA 354 695-001	1	H11 fog light, left and right, with bulb
		8GH 008 358-121	1	Spare Parts: 1x12V55W (H11)
				
3 (E46) Sedan	02/98->09/00	1N0 354 682-011	1	HB4 fog light, left, with bulb, with ribbed lens
Touring	10/99->09/00	1N0 354 682-021	1	HB4 fog light, right, with bulb, with ribbed lens
Touring	03/03->	8GH 005 636-121	1	Spare Parts: 1x12V51W (HB4)
(+) M-technique				
				
3 (E46) Sedan, Touring	09/00->	1N0 354 683-011	1	HB4 fog light, left, with bulb, clear lens
(+) M-technique		1N0 354 683-021	1	HB4 fog light, right, with bulb, clear lens
		8GH 005 636-121	1	Spare Parts: 1x12V51W (HB4)
				





**BMW**

Manufacturer Model	Model year	Part no.	Pk.	Note
BMW				
3 (E46) Sedan, Touring		2BA 008 404-011	4	Indicator light (amber), left, with bulb
3 (E46) Sedan	02/98->09/01	2BA 008 404-021	1	Indicator light (amber), right, with bulb
Touring	10/99->09/01	8GA 002 073-121	1	Spare Parts: 1x12V21W (P21W)
				
3 (E46) Sedan	02/98->09/01	2BA 008 404-031	1	Indicator light (white), left, with bulb, for conversion
Touring	10/99->09/01	2BA 008 404-041	1	Indicator light (white), right, with bulb, for conversion
		8GA 006 841-121	1	Spare Parts: 1x12V21W (PY21W)
				
3 (E46) Convertible, Coupé		1N0 354 683-011	1	HB4 fog light, left, with bulb, clear lens
3 (E46) M3 Convertible, Coupé	09/00->	1N0 354 683-021	1	HB4 fog light, right, with bulb, clear lens
(+) M-technique		8GH 005 636-121	1	Spare Parts: 1x12V51W (HB4)
				
3 (E46) Convertible	04/00->09/00	1N0 354 685-011	1	HB4 fog light, left, with bulb, with ribbed lens
Convertible	03/03->	1N0 354 685-021	1	HB4 fog light, right, with bulb, with ribbed lens
Coupé	04/99->09/00			
Coupé	03/03->	8GH 005 636-121	1	Spare Parts: 1x12V51W (HB4)
(+) M-technique				
				



Manufacturer Model	Model year	Part no.	Pk.	Note
BMW				
3 (E46) Convertible, Coupé		1N0 354 682-011	1	HB4 fog light, left, with bulb, with ribbed lens
3 (E46) M3 Convertible, Coupé	06/00->09/00	1N0 354 682-021	1	HB4 fog light, right, with bulb, with ribbed lens
3 (E46) M3 Convertible, Coupé	03/03->			Spare Parts:
(+) M-technique		8GH 005 636-121	1	1x12V51W (HB4)
				
3 (E46) Compact		1NB 354 694-011	1	H8 fog light, left, with bulb
3 (E46) Compact	06/01->02/05	1NB 354 694-021	1	H8 fog light, right, with bulb
		8GH 008 356-121	1	Spare Parts: 1x12V35W (H8)
				
3 (E90/E91) Sedan, Touring		1LL 354 687-031	1	Bi-Xenon®/H7 headlight, left, with indicator light, without bend lighting, with dynamic headlight levelling actuator, without xenon ballast, without gas discharge bulb, without bulbs
3 (E90) Sedan	01/05->09/08			
3 (E91) Touring	09/05->09/08	1LL 354 687-041	1	Bi-Xenon®/H7 headlight, right, with indicator light, without bend lighting, with dynamic headlight levelling actuator, without xenon ballast, without gas discharge bulb, without bulbs
318d, 318i, 320d, 320i, 320si, 325d, 325i, 325xi, 330d, 330i, 330xd, 330xi, 335d, 335i, 335xi				
(+) Bi-Xenon light (-) bend lighting		8GS 009 028-021	1	1x35W (D1S)
		8GH 007 157-201	1	1x12V55W (H7)
		8GA 006 841-121	1	Long Life 1x12V21W (PY21W) 1x12V10W (HML10W) Long Life
				
3 (E90) Sedan	01/05->09/08	1ZS 354 688-031	1	Bi-Xenon®/H7 headlight, left, with indicator light, with bend lighting, with dynamic headlight levelling actuator, without xenon ballast, without gas discharge bulb, without bulbs
3 (E91) Touring	09/05->09/08			
318d, 318i, 320d, 320i, 320si, 325d, 325i, 325xi, 330d, 330i, 330xd, 330xi, 335d, 335i, 335xi		1ZS 354 688-041	1	Bi-Xenon®/H7 headlight, right, with indicator light, with bend lighting, with dynamic levelling actuator, without xenon ballast, without gas discharge bulb, without bulbs
(+) Bi-Xenon light (+) bend lighting		8GS 009 028-021	1	1x35W (D1S)
		8GH 007 157-201	1	1x12V55W (H7)
		8GA 006 841-121	1	Long Life 1x12V21W (PY21W) 1x12V10W (HML10W) Long Life
				

**BMW**

Manufacturer Model	Model year	Part no.	Pk.	Note
BMW				
3 (E90/E91) Sedan, Touring				
3 (E90) Limousine, 3 (E91) Touring	09/08->	1ZS 354 692-031	1	Bi-Xenon®/H3/H8 headlight, left, without LED module for indicator light, with daytime running light, with cornering light, with bend lighting, with dynamic headlight levelling actuator, without xenon ballast, without gas discharge bulb, without bulbs
316d, 316i, 318d, 318i, 320d, 320xd, 320i, 320si, 325d, 325i, 325xi, 330d, 330i, 330xd, 330xi, 335d, 335i, 335xi, M3		1ZS 354 692-041	1	Bi-Xenon®/H3/H8 headlight, right, without LED module for indicator light, with daytime running light, with cornering light, with bend lighting, with dynamic headlight levelling actuator, without xenon ballast, without gas discharge bulb, without bulbs
(+) Bi-Xenon light (+) bend lighting		8GS 009 028-021 8GH 002 090-133 8GH 008 356-121	1 1 1	Spare Parts: 1x35W (D1S) 1x12V55W (H3) 1x12V35W (H8)
				
3 (E90) Sedan	01/05->09/08	1NA 010 502-011	1	H11 fog light, left, with bulb
3 (E91) Touring	09/05->09/08	1NA 010 502-021	1	H11 fog light, right, with bulb
(-) M sport package (-) M3		8GH 008 358-121	1	Spare Parts: 1x12V55W (H11)
				
3 (E90) Sedan	01/05->	1N0 010 345-011	1	HB4 fog light, left, with bulb
3 (E91) Touring	09/05->	1N0 010 345-021	1	HB4 fog light, right, with bulb
(+) M sport package		8GH 005 636-121	1	Spare Parts: 1x12V51W (HB4)
				
3 (E90) Sedan	01/05->09/08	2SK 010 083-801	1	Upgrade combination rearlight set (red/white)
318d, 318i, 320d, 320i, 320si, 325d, 325i, 325xi, 330d, 330i, 330xd, 330xi, 335d, 335i, 335xi		8GA 002 073-121 8GA 006 841-121 8GH 008 417-001	1 1 1	Accessories: 10x12V21W (P21W) 2x12V21W (PY21W) 2x12V21W (H21W)
				







Manufacturer Model	Model year	Part no.	Pk.	Note
BMW				
3 (E92/E93) Coupé, Convertible		1NA 354 698-011	1	H8 fog light, left, with bulb
3 (E92) Coupé	09/06->	1NA 354 698-021	1	H8 fog light, right, with bulb
3 (E93) Convertible	03/07->			Spare Parts:
(-) sport package		8GH 008 356-121	1	1x12V35W (H8)
				
5 (E28)		1NB 123 581-001	1	H3 fog light unit, left
5 (E28)	06/81->12/87	1NB 123 582-001	1	H3 fog light unit, right
		8GH 002 090-133	1	Accessories: 1x12V55W (H3)
				
5 (E28)	06/81->12/87	2BM 003 933-031	1	Auxiliary indicator light, left
		2BM 003 933-041	1	Auxiliary indicator light, right
		8GP 003 594-121	1	Accessories: 1x12V5W (W5W)
				
5 (E28)	06/81->12/87	2KA 004 331-031	4	Licence plate light
		8GM 002 092-121	1	Accessories: 1x12V5W (C5W)
				
5 (E34)	01/88->08/88			DE@-H1 headlight, only spare parts available
5 (E34) 520i, 524td, 525i, 530i, 535i		1K3 132 253-011	1	Spare Parts: Main-beam unit, left
		1K3 132 266-011	1	Main-beam unit, right
		9AH 131 741-011	2	Supporting frame, left
		9AH 131 740-011	2	Supporting frame, right
		8GH 002 089-133	1	Accessories: 2x12V55W (H1)
		8GP 003 594-121	1	1x12V5W (W5W)
5 (E34)	09/88->01/97			Super DE@-H1 headlight, for vehicles with or without headlight leveller, only spare parts available
M5, 518i, 520i, 524td, 525td, 525tds, 525i, 525iX, 530i, 535i, 540i Sedan	09/88->11/95	9BG 135 927-011	1	Spare Parts: Body with lens for dipped-beam, left
Touring	01/92->01/97	9BG 135 928-011	1	Body with lens for dipped-beam, right
		9DR 135 926-015	1	Reflector with lens (module) for dipped-beam light
		1K3 132 253-011	1	Main-beam unit, left
		1K3 132 266-011	1	Main-beam unit, right
		9AG 144 019-005	10	Lens-retaining rim
		9AH 131 741-011	2	Supporting frame, left
		9AH 131 740-011	2	Supporting frame, right
		8GH 002 089-133	1	2x12V55W (H1)
		8GP 003 594-121	1	1x12V5W (W5W)
				
5 (E34)	09/88->01/97	6NM 004 375-311	1	Headlight levelling actuator
				

**BMW**

Manufacturer Model	Model year	Part no.	Pk.	Note
BMW				
5 (E34) 5 (E34) Sedan M5, 518i, 520i, 524td, 525td, 525tds, 525i, 525iX, 530i, 535i, 540i	01/88->11/95	2VA 005 553-111	1	Combination rearlight, left, outer part (amber/red)
		2VA 005 553-121	1	Combination rearlight, right, outer part (amber/red)
		8GA 002 071-131	1	Accessories: 1x12V10W (R10W)
		8GA 002 073-121	1	2x12V21W (P21W)
5 (E34) Sedan M5, 518i, 520i, 524td, 525td, 525tds, 525i, 525iX, 530i, 535i, 540i	01/88->11/95	2VA 005 553-131	1	Combination rearlight, left, outer part (red/white), for conversion
	01/88->11/95	2VA 005 553-141	1	Combination rearlight, right, outer part (red/white), for conversion
 Design		8GA 002 071-131	1	Accessories: 1x12V10W (R10W)
		8GA 002 073-121	1	1x12V21W (P21W)
		8GA 006 841-121	1	1x12V21W (PY21W)
5 (E34) Sedan M5, 518i, 520i, 524td, 525td, 525tds, 525i, 525iX, 530i, 535i, 540i	01/88->11/95	2NR 005 554-111	1	Combination rearlight, left, inner part, with rear fog and reverse light
		2NR 005 554-121	1	Combination rearlight, right, inner part, with rear fog and reverse light
		8GM 002 091-131	1	Accessories: 1x12V10W (K)
		8GA 002 073-121	1	1x12V21W (P21W)
5 (E39) 5 (E39) 520d, 520i, 523i, 525d, 525td, 525tds, 528i, 530d, 535i, 540i Sedan	11/95->08/00	1LL 007 250-011	1	DE@-HB4/HB3 headlight, left, with body/lens for indicator light, with electric headlight levelling actuator, with bulbs
		1LL 007 250-021	1	DE@-HB4/HB3 headlight, right, with body/lens for indicator light, with electric headlight levelling actuator, with bulbs
Touring (-) M5	03/97->08/00	9ES 152 179-001	1	Spare Parts: Cover lens, left (without optical pattern)
		9ES 152 180-001	1	Cover lens, right (without optical pattern)
		8GH 005 636-121	1	1x12V51W (HB4)
		8GH 005 635-121	1	1x12V60W (HB3)
		8GP 003 594-121	1	1x12V5W (W5W)
		8GA 002 073-121	1	1x12V21W (P21W)







Manufacturer Model	Model year	Part no.	Pk.	Note
BMW				
5 (E39) 5 (E39) 520d, 520i, 523i, 525d, 525td, 525tds, 528i, 530d, 535i, 540i Sedan Touring	11/95->08/00 03/97->08/00	 1LL 008 053-591 1LL 008 053-601 8KB 157 198-801 9DX 153 746-011 8GH 007 157-121 8GA 006 841-121	1 1 1 1 1 1	Conversion for vehicles ->08/2000 with halogen dipped-beam light as standard DE@-H7/FF@-H7 headlight with clear indicator light lenses, the following components must be ordered: DE@-H7/FF@-H7 headlight, left, with indicator light (clear lens), with headlight levelling actuator, with bulbs DE@-H7/FF@-H7 headlight, right, with indicator light (clear lens), with headlight levelling actuator, with bulbs Harness Spare Parts: Reflectorgroup (CELIS@) 2x12V55W (H7) 1x12V21W (PY21W)
5 (E39) M5, 520i, 525d, 525i, 525td, 525tds, 530d, 535i, 540i Sedan Touring	09/00->06/04 09/00->07/03 09/00->06/04	 1LL 008 053-591 1LL 008 053-601 9DX 153 746-011 8GH 007 157-121 8GA 006 841-121	1 1 1 1 1	DE@-H7/FF@-H7 headlight, left, with indicator light (clear lens), with headlight levelling actuator, with bulbs DE@-H7/FF@-H7 headlight, right, with indicator light (clear lens), with headlight levelling actuator, with bulbs Spare Parts: Reflectorgroup (CELIS@) 2x12V55W (H7) 1x12V21W (PY21W)
M5 (E39) (+) Xenon light	09/00->07/03	 1LL 008 052-591 1LL 008 052-601 5DV 007 760-651 9DX 153 746-011 8GS 007 949-101 8GH 007 157-121 8GA 006 841-121	1 1 1 1 1	Xenon/FF@-H7 headlight, left, with indicator light (clear lens), with headlight levelling actuator, with xenon ballast, with gas discharge bulb, with bulbs Xenon/FF@-H7 headlight, right, with indicator light (clear lens), with headlight levelling actuator, with xenon ballast, with gas discharge bulb, with bulbs Spare Parts: Ballast unit Reflectorgroup (CELIS@) 1x35W (D2S) 1x12V55W (H7) 1x12V21W (PY21W)
5 (E39)	11/95->06/04		1	Ballast unit For vehicles ->09/98, the following components must be ordered in addition: Mounting bracket, left (BMW no. 63 12 8 386 655) Mounting bracket, right (BMW no. 63 12 8 386 656) Cover for low beam left/right (BMW no. 63 12 8 387 527)

**BMW**

Manufacturer Model	Model year	Part no.	Pk.	Note
BMW				
5 (E39) 5 (E39)	11/95->08/00	9ES 152 179-801 9ES 152 179-001 9ES 152 180-001	1 1 1	Cover lens set for headlights (without optical pattern), with lenses for indicator light (clear) and 12V21W (PY21W)-Long Life-bulbs, for conversion Spare Parts: Cover lens (without optical pattern), left, with lens for indicator light (clear) and 12V21W (PY21W)-Long Life-bulb Cover lens (without optical pattern), right, with lens for indicator light (clear) and 12V21W (PY21W)-Long Life-bulb 2x12V21W (PY21W) Long Life
				
5 (E39) (-) M-technique	09/97->08/00	1NA 009 026-011 1NA 009 026-021 8GH 007 157-121	1 1 1	FF®-H7 fog light, left, with bulb FF®-H7 fog light, right, with bulb Spare Parts: 1x12V55W (H7)
				
5 (E39) Sedan (+) M-technique	09/97->08/00	1N0 354 682-011 1N0 354 682-021 8GH 005 636-121	1 1 1	HB4 fog light, left, with bulb, with ribbed lens HB4 fog light, right, with bulb, with ribbed lens Spare Parts: 1x12V51W (HB4)
				
5 (E39) (+) M-technique	09/00->	1N0 354 683-011 1N0 354 683-021 8GH 005 636-121	1 1 1	HB4 fog light, left, with bulb, clear lens HB4 fog light, right, with bulb, clear lens Spare Parts: 1x12V51W (HB4)
				
5 (E39) (-) M5	09/00->06/04	1NA 354 693-011 1NA 354 693-021 8GH 008 356-121	1 1 1	FF®-H8 fog light, left, with bulb FF®-H8 fog light, right, with bulb Spare Parts: 1x12V35W (H8)
				



Manufacturer Model	Model year	Part no.	Pk.	Note
BMW				
5 (E39) 5 (E39) 520d, 520i, 523i, 525d, 525td, 525tds, 528i, 530d, 535i, 540i Sedan (-) M5	11/95->08/00	9EL 146 293-031 9EL 146 294-031 8GA 002 071-121 8GA 002 073-121	1 1 1 1	Body/lens for combination rearlight (amber/red), left, with rear fog and reverse light Body/lens for combination rearlight (amber/red), right, with rear fog and reverse light Accessories: 2x12V5W (R5W) 4x12V21W (P21W)
				
5 (E39) 520d, 520i, 523i, 525d, 525td, 525tds, 528i, 530d, 535i, 540i Sedan (-) M5	11/95->08/00	2VP 007 240-091 2VP 007 240-101 8GA 002 071-121 8GA 002 073-121 8GA 006 841-121	1 1 1 1 1	Combination rearlight (red/white), left, with rear fog and reverse light, with 12V21W (PY21W) bulb, for conversion Combination rearlight (red/white), right, with rear fog and reverse light, with 12V21W (PY21W) bulb, for conversion Accessories: 2x12V5W (R5W) 3x12V21W (P21W) Spare Parts: 1x12V21W (PY21W)
				
5 (E39) M5 Sedan	12/98->08/00	2VP 007 240-091 2VP 007 240-101 8GA 002 071-121 8GA 002 073-121 8GA 006 841-121	1 1 1 1 1	Combination rearlight (red/white), left, with rear fog and reverse light, with 12V21W (PY21W) bulb Combination rearlight (red/white), right, with rear fog and reverse light, with 12V21W (PY21W) bulb Accessories: 2x12V5W (R5W) 3x12V21W (P21W) Spare Parts: 1x12V21W (PY21W)
				
5 (E39) 520d, 520i, 523i, 525d, 525td, 525tds, 528i, 530d, 535i, 540i Sedan	11/95->08/00	2VP 008 272-821 8GA 002 073-121 8GA 006 841-121 8GA 008 246-001	1 1 1	CELIS® LED combination rearlight set (black/red), with LED tail light Accessories: 4x12V21W (P21W) 2x12V21W (PY21W) 2x12V16W (W16W)
				

**BMW**

Manufacturer Model	Model year	Part no.	Pk.	Note
BMW				
5 (E39) 5 (E39) 520d, 520i, 523i, 525d, 525td, 525tds, 528i, 530d, 535i, 540i Sedan	11/95->08/00	2VP 008 272-861	1	CELIS® LED combination rearlight set (white/red), with LED tail light
		9EL 153 567-101	1	Spare Parts: Body/lens, left
		8GA 002 073-121	1	Accessories: 6x12V21W (P21W)
		8GA 006 841-121	1	2x12V21W (PY21W)
5 (E39) 520d, 520i, 523i, 525d, 525td, 525tds, 528i, 530d, 535i, 540i Sedan	11/95->08/00	2SK 008 272-831	1	CELIS® LED combination rearlight set (brilliant silver), with LED tail light
		8GA 002 073-121	1	Accessories: 6x12V21W (P21W)
		8GA 006 841-121	1	2x12V21W (PY21W)
5 (E39) 520i, 525d, 525i, 525td, 525tds, 530d, 535i, 540i Sedan (-) M5	09/00->07/03	2VP 008 272-231	1	Combination rearlight, left, with rear fog and reverse light, with LED tail light, with bulbs, indicator with amber lens
		2VP 008 272-241	1	Combination rearlight, right, with rear fog and reverse light, with LED tail light, with bulbs, indicator with amber lens
		8GA 002 073-121	1	Spare Parts: 4x12V21W (P21W)
5 (E39) 520i, 525d, 525i, 525td, 525tds, 530d, 535i, 540i Sedan (-) M5	09/00->07/03	2VP 008 272-211	1	Combination rearlight, left, with rear fog and reverse light, with LED tail light, with bulbs, indicator with clear lens, for conversion
		2VP 008 272-221	1	Combination rearlight, right, with rear fog and reverse light, with LED tail light, with bulbs, indicator with clear lens, for conversion
		8GA 002 073-121	1	Spare Parts: 3x12V21W (P21W)
		8GA 006 841-121	1	1x12V21W (PY21W)



Manufacturer Model	Model year	Part no.	Pk.	Note
BMW				
5 (E39) 5 (E39) M5 Sedan	09/00->07/03	2VP 008 272-211 2VP 008 272-221 8GA 002 073-121 8GA 006 841-121	1 1 1 1	Combination rearlight, left, with rear fog and reverse light, with LED tail light, with bulbs, indicator with clear lens Combination rearlight, right, with rear fog and reverse light, with LED tail light, with bulbs, indicator with clear lens Spare Parts: 3x12V21W (P21W) 1x12V21W (PY21W)
5 (E39) 520i, 525d, 525i, 525td, 525tds, 530d, 535i, 540i Sedan	09/00->07/03	2VP 008 272-811 8GA 002 073-121 8GA 006 841-121	1 1 1	CELIS® LED combination rearlight set (grey/red), with LED tail light Accessories: 6x12V21W (P21W) 2x12V21W (PY21W)
5 (E39) 520i, 525d, 525i, 525td, 525tds, 530d, 535i, 540i Sedan	09/00->07/03	2SK 008 272-801 8GA 002 073-121 8GA 006 841-121	1 1 1	CELIS® LED combination rearlight set (brilliant silver), with LED tail light Accessories: 6x12V21W (P21W) 2x12V21W (PY21W)
5 (E60, E61) 5 (E60, E61) 520d, 520i, 523i, 525d, 525i, 525xi, 530d, 525xd, 530i, 530xd, 530xi, 535d, 540i, 545i, 550i Sedan Touring	07/03->03/07 06/04->03/07	1LF 008 673-091 1LF 008 673-101 8GH 007 157-121 8GA 006 841-121 8GP 003 594-121	1 1 1 1 1	FF®-H7 headlight, left, with indicator light (white lens), with white LED side-marker light, with dynamic headlight levelling actuator, with bulbs FF®-H7 headlight, right, with indicator light (white lens), with white LED side-marker light, with dynamic headlight levelling actuator, with bulbs Spare Parts: 2x12V55W (H7) 1x12V21W (PY21W) 2x12V5W (W5W)





**BMW**

Manufacturer Model	Model year	Part no.	Pk.	Note
BMW				
5 (E60, E61) 5 (E60, E61) M5, 520i, 525d, 525i, 530d, 530i, 530xd, 535d, 545i Sedan Touring (+) Bi-Xenon light (-) bend lighting	07/03->12/04	1LL 160 695-001	1	Bi-Xenon®/FF®-H7 headlight, left, with indicator light (white lens), with white LED side-marker light, with dynamic headlight levelling actuator, without xenon ballast, without gas discharge bulb, with bulbs Bi-Xenon®/FF®-H7 headlight, right, with indicator light (white lens), with white LED side-marker light, with dynamic headlight levelling actuator, without xenon ballast, without gas discharge bulb, with bulbs Spare Parts: Reflectorgroup (CELIS®) Accessories: Ballast unit 1x35W (D2S) Spare Parts: 1x12V55W (H7) 1x12V21W (PY21W) 1x12V10W (H10W)
		1LL 160 696-001	1	
	06/04->12/04	9DX 159 419-001	1	
		5DV 008 290-004 8GS 007 949-101 8GH 007 157-121 8GA 006 841-121	1 1 1 1	
5 (E60, E61) 520d, 520i, 523i, 525d, 525i, 525xi, 530d, 525xd, 530i, 530xd, 530xi, 535d, 550i Sedan, Touring (+) Bi-Xenon light (-) bend lighting	01/05->03/07	1LL 163 081-001	1	Bi-Xenon®/FF®-H7 headlight, left, with indicator light (white lens), with white LED side-marker light, with dynamic headlight levelling actuator, without xenon ballast, without gas discharge bulb, with bulbs Bi-Xenon®/FF®-H7 headlight, right, with indicator light (white lens), with white LED side-marker light, with dynamic headlight levelling actuator, without xenon ballast, without gas discharge bulb, with bulbs Spare Parts: Reflectorgroup (CELIS®) Accessories: Ballast unit 1x35W (D1S) Spare Parts: 1x12V55W (H7) 1x12V21W (PY21W) Silver Vision 1x12V10W (H10W)
		1LL 163 082-001	1	
	04/07->	9DX 159 419-001	1	
		5DV 009 000-001 8GS 009 028-021 8GH 007 157-121	1 1 1	
5 (E60, E61) 520d, 520i, 523i, 525d, 525i, 525xi, 525xd, 530d, 530xd, 530xi, 535d, 540i, 545i, 550i Sedan, Touring	04/07->	1LL 009 449-031	1	DE®-H7 headlight, left, with indicator light (white lens), with white LED side-marker light, with bulbs DE®-H7 headlight, right, with indicator light (white lens), with white LED side-marker light, with bulbs Spare Parts: 2x12V55W (H7) 1x12V21W (PY21W) 1x12V10W (H10W)
		1LL 009 449-041	1	
	04/07->	8GH 007 157-121 8GA 006 841-121	1 1	





Manufacturer Model	Model year	Part no.	Pk.	Note
BMW				
5 (E60, E61) 5 (E60, E61) M5, 520d, 520i, 523i, 525d, 525i, 525xi, 525xd, 530d, 530xi, 535d, 540i, 545i, 550i, 530xd, Sedan, Touring (+) Bi-Xenon light (-) bend lighting	04/07->	1LL 164 909-001	1	Bi-Xenon® headlight, left, with indicator light (clear lens), with H8 daytime running light, with white LED side-marker light, with dynamic headlight levelling actuator, without xenon ballast, without gas discharge bulb, with bulbs
		1LL 164 910-001	1	Bi-Xenon® headlight, right, with indicator light (clear lens), with H8 daytime running light, with white LED side-marker light, with dynamic headlight levelling actuator, without xenon ballast, without gas discharge bulb, with bulbs
		5DV 009 000-001	1	Accessories: Ballast unit
		8GS 009 028-021 8GH 008 356-121 8GA 006 841-121	1 1 1	Spare Parts: 1x35W (D1S) 1x12V35W (H8) 1x12V21W (PY21W)
5 (E60, E61) M5, 520d, 520i, 523i, 525d, 525i, 525xi, 525xd, 530d, 530xd, 530xi, 535d, 540i, 545i, 550i Sedan, Touring (+) Bi-Xenon light (+) bend lighting	04/07->	1ZS 169 009-131	1	Bi-Xenon®/H3 headlight, left, with indicator light (clear lens), with cornering light, with H8 daytime running light, with white LED side-marker light, with dynamic headlight levelling actuator, without xenon ballast, without gas discharge bulb, with bulbs
		1ZS 169 009-141	1	Bi-Xenon®/H3 headlight, right, with indicator light (clear lens), with cornering light, with H8 daytime running light, with white LED side-marker light, with dynamic headlight levelling actuator, without xenon ballast, without gas discharge bulb, with bulbs
		5DV 009 000-001	1	Accessories: Ballast unit
		8GS 009 028-021 8GH 002 090-133 8GH 008 356-121 8GA 006 841-121	1 1 1 1	Spare Parts: 1x35W (D1S) 1x12V55W (H3) 1x12V35W (H8) 1x12V21W (PY21W)
5 (E60, E61) Sedan, Touring	07/03->12/04	5DV 008 290-004	1	Ballast unit
5 (E60, E61) Sedan, Touring	07/03->12/04			
		5DD 008 319-501	1	Ignitor, gas discharge bulb
				



**BMW**

Manufacturer Model	Model year	Part no.	Pk.	Note
BMW				
5 (E60, E61) 5 (E60, E61) Sedan, Touring	01/05->	5DV 009 000-001	1	Ballast unit
				
5 (E60, E61) Sedan, Touring (-) M-technique	07/03->	1N0 010 345-011 1N0 010 345-021 8GH 005 636-121	1 1 1	HB4 fog light, left, with bulb HB4 fog light, right, with bulb Spare Parts: 1x12V51W (HB4)
				
5 (E60, E61) Sedan, Touring (+) M-technique (-) M5	07/03->	1N0 354 696-011 1N0 354 696-021 8GH 005 636-121	1 1 1	HB4 fog light, left, with bulb HB4 fog light, right, with bulb Spare Parts: 1x12V51W (HB4)
				
5 (E60, E61) M5, 520d, 520i, 523i, 525i, 525xi, 530d, 525xd, 530i, 530xd, 530xi, 535d, 540i, 545i, 550i Sedan	07/03->03/07	2VP 008 679-111 2VP 008 679-121 8GA 008 246-001	1 1 1	Combination rearlight (clear/red), left, with rear fog and reverse light, with bulbs Combination rearlight (clear/red), right, with rear fog and reverse light, with bulbs Spare Parts: 1x12V16W (W16W)
				
5 (E60, E61) M5, 520d, 520i, 523i, 525i, 525xi, 530d, 525xd, 530i, 530xd, 530xi, 535d, 540i, 545i, 550i Sedan	07/03->03/07	2SK 008 679-811	1	Upgrade combination rearlight set (brilliant), with Diadem bulbs
				







Manufacturer Model	Model year	Part no.	Pk.	Note
BMW				
5 (E60, E61) 5 (E60, E61) M5, 520d, 520i, 523i, 525i, 525xi, 530d, 525xd, 530i, 530xd, 530xi, 535d, 540i, 545i, 550i Sedan	07/03->03/07	2SK 008 679-831	1	Upgrade combination rearlight set (brilliant/red), with Diadem bulbs
				
5 (E60) M5, 520d, 520i, 523i, 525i, 525xi, 530d, 525xd, 530i, 530xd, 530xi, 535d, 540i, 545i, 550i Sedan	07/03->03/07	9EL 008 679-841	1	Upgrade combination rearlight set (black), without bulb holder
				
5 (E60) M5, 520d, 520i, 523i, 525d, 525i, 525xi, 525xd, 530d, 530xd, 530xi, 535d, 540i, 545i, 550i Sedan	04/07->	2VP 009 425-111 2VP 009 425-121 8GA 002 073-271 8GA 008 246-001	1 1 1 1	Combination rearlight, left, with rear fog and reverse light, with LED indicator light and LED tail light, with bulbs Combination rearlight, right, with rear fog and reverse light, with LED indicator light and LED tail light, with bulbs Spare Parts: 3x12V21W (P21W) Long Life 1x12V16W (W16W)
				
5 (E61) M5, 520d, 520i, 523i, 525d, 525i, 525xi, 525xd, 530d, 530xd, 530xi, 535d, 540i, 545i, 550i Touring	04/07->	2VA 009 426-111 2VA 009 426-121 8GA 002 073-271	1 1 1	Combination rearlight, left, outer part, with LED indicator light and LED tail light, with bulbs Combination rearlight, right, outer part, with LED indicator light and LED tail light, with bulbs Spare Parts: 2x12V21W (P21W) Long Life
				

**BMW**

Manufacturer Model	Model year	Part no.	Pk.	Note
BMW				
5 (E60, E61) 5 (E61) M5, 520d, 520i, 523i, 525d, 525i, 525xi, 525xd, 530d, 530xd, 530xi, 535d, 540i, 545i, 550i Touring	04/07->	2TZ 009 427-111 2TZ 009 427-121 8GA 008 246-001	1 1 1	Combination rearlight, left, inner part, with rear fog and reverse light, with bulbs Combination rearlight, right, inner part, with rear fog and reverse light, with bulbs Spare Parts: 2x12V16W (W16W)
				
5 (F10, F11) 5 (F10, F11) 520d, 523i, 525d, 528i, 530d, 535d, 535i, 550i Sedan Touring	03/10-> 03/10-> 09/10->	1LL 010 131-031 1LL 010 131-041 8GH 007 157-201	1 1 1	DE@-H7/FF@-H7 headlight, left, with indicator light, with electric headlight levelling actuator DE@-H7/FF@-H7 headlight, right, with indicator light, with electric headlight levelling actuator Accessories: 2x12V55W (H7) Long Life Spare Parts: 1x12V24W (PY24W)
				
5 (F10, F11) 520d, 523i, 525d, 528i, 530d, 535d, 535i, 550i Sedan Touring (+) Bi-Xenon light (-) bend lighting	03/10-> 03/10-> 09/10->	1LL 010 131-531 1LL 010 131-541 9DW 177 231-011 9DW 177 231-021 9DW 177 229-001 8GS 009 028-021	1 1 1 1 1 1	Bi-Xenon@ headlight, left, without LED module for indicator light, without LED module for daytime running light, without bend lighting, with dynamic headlight levelling actuator, without xenon ballast, without gas discharge bulb Bi-Xenon@ headlight, right, without LED module for indicator light, without LED module for daytime running light, without bend lighting, with dynamic headlight levelling actuator, without xenon ballast, without gas discharge bulb Accessories: LED module for indicator light, left LED module for indicator light, right Repair set for LED daytime running light 1x35W (D1S)
				



Manufacturer Model	Model year	Part no.	Pk.	Note
BMW				
5 (F10, F11) 5 (F10, F11) 520d, 523i, 525d, 528i, 530d, 535d, 535i, 550i Sedan Touring (+) Bi-Xenon light (+) bend lighting 	03/10-> 03/10-> 09/10->	1ZS 010 131-631 1ZS 010 131-641 9DW 177 231-011 9DW 177 231-021 9DW 177 229-001 8GS 009 028-021 8GH 007 157-201	1 1 1 1 1 1 1	Bi-Xenon®/H7 headlight, left, without LED module for indicator light, without LED module for daytime running light, with bend lighting, with dynamic headlight levelling actuator, without xenon ballast, without gas discharge bulb, without bulbs Bi-Xenon®/H7 headlight, right, without LED module for indicator light, without LED module for daytime running light, with bend lighting, with dynamic headlight levelling actuator, without xenon ballast, without gas discharge bulb, without bulbs Accessories: LED module for indicator light, left LED module for indicator light, right Repair set for LED daytime running light 1x35W (D1S) 1x12V55W (H7) Long Life
6 (E24) 6 (E24) 628 CSi, 635 CSi 	06/82->05/87	1K3 126 680-001 8GH 002 089-133	1 1	H1 spotlight unit, right Accessories: 1x12V55W (H1)
6 (E24) 	06/82->05/87	1NB 123 581-001 1NB 123 582-001 8GH 002 090-133	1 1 1	H3 fog light unit, left H3 fog light unit, right Accessories: 1x12V55W (H3)
6 (E24) 	04/76->09/90	2BM 003 933-031 2BM 003 933-041 8GP 003 594-121	1 1 1	Auxiliary indicator light, left Auxiliary indicator light, right Accessories: 1x12V5W (W5W)
6 (E24) 	04/76->09/90	2KA 004 331-031 8GM 002 092-121	4 1	Licence plate light Accessories: 1x12V5W (C5W)
6 (E63/E64) 6 (E63) Coupé 6 (E64) Convertible 	01/04->07/07 04/04->07/07	1N0 010 345-011 1N0 010 345-021 8GH 005 636-121	1 1 1	HB4 fog light, left, with bulb HB4 fog light, right, with bulb Spare Parts: 1x12V51W (HB4)

**BMW**

Manufacturer Model	Model year	Part no.	Pk.	Note
BMW				
7 (E23) 7 (E23)	07/82->08/86	1NB 123 581-001 1NB 123 582-001 8GH 002 090-133	1 1 1	H3 fog light unit, left H3 fog light unit, right Accessories: 1x12V55W (H3)
				
7 (E23)	05/77->08/86	2KA 004 331-031 8GM 002 092-121	4 1	Licence plate light Accessories: 1x12V5W (C5W)
				
7 (E32) 7 (E32) 730i, 735i, 750i	09/86->08/88	1K3 132 253-011 1K3 132 266-011 9AH 131 741-011 9AH 131 740-011 8GH 002 089-133 8GP 003 594-121	1 1 2 2 1 1	DE@-H1 headlight, only spare parts available Spare Parts: Main-beam unit, left Main-beam unit, right Supporting frame, left Supporting frame, right Accessories: 2x12V55W (H1) 1x12V5W (W5W)
				
7 (E32) 730i, 735i, 740i, 750i	09/88->09/94	9BG 135 927-011 9BG 135 928-011 9DR 135 926-015 1K3 132 253-011 1K3 132 266-011 9AG 144 019-005 9AH 131 741-011 9AH 131 740-011 8GH 002 089-133 8GP 003 594-121	1 1 1 1 1 10 2 2 1 1	Super DE@-H1 headlight, for vehicles with or without headlight leveller, only spare parts available Spare Parts: Body with lens for dipped-beam, left Body with lens for dipped-beam, right Reflector with lens (module) for dipped-beam light Main-beam unit, left Main-beam unit, right Lens-retaining rim Supporting frame, left Supporting frame, right 2x12V55W (H1) 1x12V5W (W5W)
				
7 (E32)	09/88->09/94	6NM 004 375-311	1	Headlight levelling actuator
				
7 (E32)	01/89->09/94	1NL 005 230-111 1NL 005 230-121 8GH 002 089-133	1 1 1	DE@-H1 fog light, left DE@-H1 fog light, right Accessories: 1x12V55W (H1)
				
7 (E32)	09/86->09/94	2BM 003 933-031 2BM 003 933-041 8GP 003 594-121	1 1 1	Auxiliary indicator light, left Auxiliary indicator light, right Accessories: 1x12V5W (W5W)
				
7 (E32)	09/86->09/94	2KA 004 331-031 8GM 002 092-121	4 1	Licence plate light Accessories: 1x12V5W (C5W)
				



Manufacturer Model	Model year	Part no.	Pk.	Note
BMW				
7 (E38) 7 (E38) (-) Diesel	10/94->11/01	1NA 007 039-011 1NA 007 039-021 8GH 002 090-133	1 1 1	FF®-H3 fog light, left, with bulb FF®-H3 fog light, right, with bulb Spare Parts: 1x12V55W (H3)
				
7 (E38) 725tds, 730d, 740d	04/96->11/01	1NA 010 072-011 1NA 010 072-021 8GH 007 157-121	1 1 1	H7 fog light, left H7 fog light, right Accessories: 1x12V55W (H7)
				
7 (E65, E66) 7 (E65, E66) 730d, 730i, 735i, 740d, 745d, 745i, 760i	11/01->03/05	1LL 008 420-331 1LL 008 420-341 8GH 007 157-121 8GA 002 073-121 8GP 003 594-121	1 1 1 1 1	DE®-H7/FF®-H7 headlight, left, with indicator light (clear lens), with headlight levelling actuator, with bulbs DE®-H7/FF®-H7 headlight, right, with indicator light (clear lens), with headlight levelling actuator, with bulbs Spare Parts: 2x12V55W (H7) 1x12V21W (P21W) 1x12V5W (W5W)
				
7 (E65, E66) 730d, 730i, 735i, 740d, 745d, 745i, 760i (+) Bi-Xenon light	11/01->03/05	1LL 158 085-011 1LL 158 086-011 9DX 159 419-001 5DV 008 290-004 8GS 007 949-101 8GH 007 157-121 8GA 006 841-121	1 1 1 1 1 1 1	Bi-Xenon®/H7 headlight, left, with indicator light (clear lens), with electric headlight levelling actuator, without xenon ballast, without gas discharge bulb, with bulbs Bi-Xenon®/H7 headlight, right, with indicator light (clear lens), with electric headlight levelling actuator, without xenon ballast, without gas discharge bulb, with bulbs Spare Parts: Reflectorgroup (CELIS®) Accessories: Ballast unit Spare Parts: 1x35W (D2S) 1x12V55W (H7) 1x12V21W (PY21W)
				
7 (E65, E66)	11/01->03/05	5DV 008 290-004	1	Ballast unit
				
7 (E65, E66)	11/01->03/05	5DD 008 319-501	1	Ignitor, gas discharge bulb
				



Manufacturer Model	Model year	Part no.	Pk.	Note
BMW				
7 (E65, E66) 7 (E65, E66)	03/05->	5DV 009 000-001	1	Ballast unit
				
7 (E65, E66)	03/05->	1N0 354 686-011 1N0 354 686-021 8GH 005 636-121	1 1 1	HB4 fog light, left, with bulb HB4 fog light, right, with bulb Spare Parts: 1x12V51W (HB4)
				
7 (F01, F02, F03, F04) 7 (F01, F02, F03, F04) 730d, 740d, 740i, 750i (-) bend lighting	10/08->	1LL 354 689-031 1LL 354 689-041 8GS 009 028-021 8GH 008 356-121	1 1 1 1	Bi-Xenon®/H8 headlight, left, without LED module for indicator light, with daytime running light, without bend lighting, with dynamic headlight levelling actuator, without xenon ballast, without gas discharge bulb, without bulbs Bi-Xenon®/H8 headlight, right, without LED module for indicator light, with daytime running light, without bend lighting, with dynamic headlight levelling actuator, without xenon ballast, without gas discharge bulb, without bulbs Spare Parts: 1x35W (D1S) 1x12V35W (H8)
				
7 (F01, F02, F03, F04) 730d, 740d, 740i, 750i (+) bend lighting	10/08->	1ZS 354 690-031 1ZS 354 690-041 8GS 009 028-021 8GH 002 090-133 8GH 008 356-121	1 1 1 1 1	Bi-Xenon®/H3/H8 headlight, left, without LED module for indicator light, with daytime running light, with cornering light, with bend lighting, with dynamic headlight levelling actuator, without xenon ballast, without gas discharge bulb, without bulbs Bi-Xenon®/H3/H8 headlight, right, without LED module for indicator light, with daytime running light, with cornering light, with bend lighting, with dynamic headlight levelling actuator, without xenon ballast, without gas discharge bulb, without bulbs Spare Parts: 1x35W (D1S) 1x12V55W (H3) 1x12V35W (H8)
				
Chrysler				
PT Cruiser PT Cruiser	06/00->	6NM 007 878-351	1	Headlight levelling actuator
				







Manufacturer Model	Model year	Part no.	Pk.	Note
Citroën				
Berlingo (MF, M_) Berlingo	11/02->12/09	1LG 010 196-031 1LG 010 196-041 8GJ 002 525-131 8GA 006 841-121 8GP 003 594-121	1 1 1 1 1	H4 headlight, left, with indicator light, with electric headlight levelling actuator H4 headlight, right, with indicator light, with electric headlight levelling actuator Spare Parts: 1x12V60/55W (H4) 1x12V21W (PY21W) 1x12V5W (W5W)
C2 (JM_) C2 (JM_)	09/03->07/05	2VP 354 030-011 2VP 354 030-021 8GD 002 078-121 8GA 002 073-121 8GA 006 841-121	1 1 1 1 1	Combination rearlight, left, with rear fog and reverse light Combination rearlight, right, with rear fog and reverse light Accessories: 1x12V21/5W (P21/5W) 2x12V21W (P21W) 1x12V21W (PY21W)
C2 (JM_)	08/05->12/09	2VP 354 030-031 2VP 354 030-041 8GD 002 078-121 8GA 002 073-121 8GA 006 841-121	1 1 1 1 1	Combination rearlight, left, with rear fog and reverse light Combination rearlight, right, with rear fog and reverse light Accessories: 1x12V21/5W (P21/5W) 2x12V21W (P21W) 1x12V21W (PY21W)
C3 (A51) C3 (A51)	11/09->	1LJ 354 674-031 1LJ 354 674-041 8GH 007 157-121 8GH 002 089-133 8GA 006 841-121 8GP 003 594-121	1 1 1 1 1 1	H1/H7 headlight, left, with indicator light, with electric headlight levelling actuator H1/H7 headlight, right, with indicator light, with electric headlight levelling actuator Accessories: 2x12V55W (H7) 1x12V55W (H1) 1x12V21W (PY21W) 1x12V5W (W5W)
C3 Picasso (A58) C3 Picasso (A58)	02/09->	1LG 009 767-031 1LG 009 767-041 8GH 007 157-121 8GH 002 089-133 8GH 008 417-001 8GP 003 594-121	1 1 1 1 1 1	FF®-H7/H1 headlight, left, with indicator light, with electric headlight levelling actuator, with bulbs FF®-H7/H1 headlight, right, with indicator light, with electric headlight levelling actuator, with bulbs Spare Parts: 1x12V55W (H7) 1x12V55W (H1) 1x12V21W (H21W) 1x12V5W (W5W)



Manufacturer Model	Model year	Part no.	Pk.	Note
Citroën				
C4 (LC_) C4 (LC_) 5-doors	11/04->	9EL 354 050-011 9EL 354 050-021	1 1	Body/lens for combination rearlight, left Body/lens for combination rearlight, right
		8GD 002 078-121 8GA 006 841-121 8GP 003 594-121	1 1 1	Accessories: 1x12V21/5W (P21/5W) 1x12V21W (PY21W) 1x12V5W (W5W)
C4 (LC_) 5-doors	11/04->	2NE 354 051-021 8GA 002 073-121	1 1	Body/lens for rear fog light, right Spare Parts: 1x12V21W (P21W)
C4 (LC_) 5-doors	11/04->	2ZR 354 052-011 8GA 002 073-121	1 1	Body/lens for reverse light, left Spare Parts: 1x12V21W (P21W)
C4 (LC_) 5-doors	11/04->	2XX 354 033-011 2XX 354 033-021	1 1	Reflex-reflector (red), left Reflex-reflector (red), right
C4 Coupé (LA_) C4 Coupé (LA_) 3-doors up to organisation no. 11577	11/04->08/08	2SK 354 032-011 2SK 354 032-021 8GD 002 078-121 8GA 002 073-121 8GA 006 841-121	1 1 1 1 1	Combination rearlight, left Combination rearlight, right Accessories: 1x12V21/5W (P21/5W) 1x12V21W (P21W) 1x12V21W (PY21W)







Manufacturer Model	Model year	Part no.	Pk.	Note
Citroën				
C4 Coupé (LA_) C4 Coupé (LA_) 3-doors	11/04->	2NE 354 053-011 2NE 354 053-021 8GA 002 073-121	1 1 1	Rear fog light, left Rear fog light, right Accessories: 1x12V21W (P21W)
				
C4 Picasso (UD_,UA_) C4 Picasso (UD_) C4 Grand Picasso (UA_)	02/07->10/10 10/06->10/10	1LF 009 237-031 1LF 009 237-041 8GH 007 157-121 8GH 002 089-133 8GH 007 643-121 8GH 008 417-001	1 1 1 1 1 1	FF®-H7/FF®-H1 headlight, left, with indicator light, with electric headlight levelling actuator, with bulbs FF®-H7/FF®-H1 headlight, right, with indicator light, with electric headlight levelling actuator, with bulbs Spare Parts: 1x12V55W (H7) 1x12V55W (H1) 1x12V6W (H6W) 1x12V21W (H21W)
				
C4 Picasso (UD_) C4 Grand Picasso (UA_)	02/07-> 10/06->	5DV 009 000-001	1	Ballast unit
				
C4 Grand Picasso (UA_) 7 seats	10/06->	2SK 009 466-131 2SK 009 466-141 8GA 002 073-121 8GA 006 841-121	1 1 1 1	Combination rearlight, left, with LED tail light and reverse light Combination rearlight, right, with LED tail light and reverse light Accessories: 2x12V21W (P21W) 1x12V21W (PY21W)
				
C4 Picasso (UD_) 5 seats C4 Grand Picasso (UA_) 7 seats	02/07-> 10/06->	2NR 982 008-111 2NR 982 008-121 8GA 002 073-121	1 1 1	Rear fog light, left, with bulb Rear fog light, right, with bulb Spare Parts: 1x12V21W (P21W)
				



Manufacturer Model	Model year	Part no.	Pk.	Note
Citroën				
DS3 (A55)		2VA 354 675-031	1	Combination rearlight, left, with reverse light
DS3 (A55)	04/10->	2VA 354 675-041	1	Combination rearlight, right, with rear fog light
		8GD 002 078-221	1	Accessories: 1x12V21/5W (P21/5W) Long Life
		8GA 002 073-121	1	1x12V21W (P21W) 1x12V21W (PY21W) Silver Vision
Fiat				
Multipla (186)		2BA 270 016-031	1	Indicator light (amber), left, with bulb
Multipla (186)	04/99->09/04	2BA 270 016-041	1	Indicator light (amber), right, with bulb
		8GH 008 417-001	1	Spare Parts: 1x12V21W (H21W)
Punto (176)		1LF 006 826-251	1	FF®-H1 headlight, left, with manual headlight leveller, also suitable for vehicles with electric headlight leveller
Punto (176) AP, Elegant, Elegant XL, ELX, GT	09/93->09/99	1LF 006 826-261	1	FF®-H1 headlight, right, with manual headlight leveller, also suitable for vehicles with electric headlight leveller
(-) Sporting		8GH 002 089-133	1	Spare Parts: 2x12V55W (H1)
		8GP 003 594-121	1	1x12V5W (W5W)
Punto (176)	09/93->09/99	6NM 007 282-661	1	Headlight levelling actuator
				
Punto (176) EL, S, SX	09/93->09/99	2BA 006 749-071	1	Indicator light (amber), left
(-) Sporting		2BA 006 749-081	1	Indicator light (amber), right
		8GA 002 073-121	1	Accessories: 1x12V21W (P21W)
Punto (176) EL, S, SX	09/93->09/99	2BA 006 749-051	1	Indicator light (white), left, for conversion
(-) Sporting		2BA 006 749-061	1	Indicator light (white), right, for conversion
		8GA 002 073-121	1	Accessories: 1x12V21W (P21W)



Manufacturer Model	Model year	Part no.	Pk.	Note
Fiat				
Punto (176) Punto (176) AP, Elegant, Elegant XL, ELX, GT (-) Sporting	09/93->09/99	2BA 006 749-051 2BA 006 749-061 8GA 002 073-121	1 1 1	Indicator light (white), left Indicator light (white), right Accessories: 1x12V21W (P21W)
				
Ford				
C-Max C-Max	02/07->12/10	1LJ 009 587-631 1LJ 009 587-641 8GH 007 157-121 8GH 002 089-133 8GA 006 841-121 8GP 003 594-121	1 1 1 1 1 1	FF®-H7/FF®-H1 headlight, left, with indicator light, with electric headlight levelling actuator, with bulbs FF®-H7/FF®-H1 headlight, right, with indicator light, with electric headlight levelling actuator, with bulbs Spare Parts: 1x12V55W (H7) 1x12V55W (H1) 1x12V21W (PY21W) 1x12V5W (W5W)
				
C-Max	02/07->12/10	5DV 009 000-001	1	Ballast unit
				
Escort V, VI Escort V, VI Estate	07/90->01/95	9EL 137 819-031 9EM 137 820-021 8GA 002 071-121 8GA 002 073-121	1 1 1 1	Body/lens for combination rearlight, left, with reverse light Body/lens for combination rearlight, right, with rear fog and reverse light Spare Parts: 1x12V5W (R5W) 3x12V21W (P21W)
				
Escort VII Escort VII	01/95->10/98	1NE 007 517-051 1NE 007 517-061 8GH 002 090-133	1 1 1	FF®-H3 fog light, left FF®-H3 fog light, right Accessories: 1x12V55W (H3)
				

**Ford**

Manufacturer Model	Model year	Part no.	Pk.	Note
Ford				
Escort VII Escort VII Estate	01/95->02/99	9EL 137 819-031 9EM 137 820-021 8GA 002 071-121 8GA 002 073-121	1 1 1 1	Body/lens for combination rearlight, left, with reverse light Body/lens for combination rearlight, right, with rear fog and reverse light Spare Parts: 1x12V5W (R5W) 3x12V21W (P21W)
				
Fiesta III (GFJ) Fiesta III (GFJ)	01/89->12/93	2BA 919 370-051 2BA 919 370-061 8GA 006 841-121	1 1 1	Indicator light (white), left, with bulb, for conversion Indicator light (white), right, with bulb, for conversion Spare Parts: 1x12V21W (PY21W)
				
Fiesta III (GFJ)	01/94->12/95	2BA 919 370-051 2BA 919 370-061 8GA 006 841-121	1 1 1	Indicator light (white), left, with bulb Indicator light (white), right, with bulb Spare Parts: 1x12V21W (PY21W)
				
Fiesta V (JH_, JD_) Fiesta V (JH_, JD_)	11/01->10/05	1LF 010 197-031 1LF 010 197-041 8GJ 002 525-131 8GA 006 841-121 8GP 003 594-121	1 1 1 1 1	H4 headlight, left, with indicator light, with electric headlight levelling actuator H4 headlight, right, with indicator light, with electric headlight levelling actuator Spare Parts: 1x12V60/55W (H4) 1x12V21W (PY21W) 1x12V5W (W5W)
				
Fiesta V (JH_, JD_) 3-doors	10/05->	9EL 354 055-011 9EL 354 055-021 8GA 006 841-121 8GA 002 073-121 8GP 003 594-121 8GA 008 246-001	1 1 1 1 1 1	Body/lens for combination rearlight, left, with rear fog and reverse light Body/lens for combination rearlight, right, with rear fog and reverse light Accessories: 1x12V21W (PY21W) 1x12V21W (P21W) 1x12V5W (W5W) 1x12V16W (W16W)
				









Manufacturer Model	Model year	Part no.	Pk.	Note
Ford				
Fiesta V (JH_, JD_)		9EL 354 054-011	1	Body/lens for combination rearlight, left, with rear fog and reverse light
Fiesta V (JH_, JD_) 5-doors	10/05->	9EL 354 054-021	1	Body/lens for combination rearlight, right, with rear fog and reverse light
		8GA 006 841-121	1	Accessories: 1x12V21W (PY21W)
		8GA 002 073-121	1	1x12V21W (P21W)
		8GP 003 594-121	1	1x12V5W (W5W)
		8GA 008 246-001	1	1x12V16W (W16W)
				
Fiesta VI		1LJ 247 045-331	1	H7/H1 headlight, left, with indicator light, with bulbs
Fiesta VI (-) Ghia, Sport	10/08->	1LJ 247 045-341	1	H7/H1 headlight, right, with indicator light, with bulbs
		8GH 007 157-121	1	1x12V55W (H7)
		8GH 002 089-133	1	1x12V55W (H1)
		8GA 006 841-121	1	1x12V21W (PY21W)
		8GP 003 594-121	1	1x12V5W (W5W)
				
Fiesta VI Ghia, Sport		1LL 247 045-371	1	H7/H1 headlight, left, with indicator light, with bulbs
	10/08->	1LL 247 045-381	1	H7/H1 headlight, right, with indicator light, with bulbs
		8GH 007 157-121	1	1x12V55W (H7)
		8GH 002 089-133	1	1x12V55W (H1)
		8GA 006 841-121	1	1x12V21W (PY21W)
		8GP 003 594-121	1	1x12V5W (W5W)
				
Fiesta VI		9EL 354 667-011	1	Body/lens for combination rearlight, left, with reverse light
	10/08->	9EL 354 667-021	1	Body/lens for combination rearlight, right, with reverse light
		8GD 002 078-221	1	Accessories: 1x12V21/5W (P21/5W) Long Life
		8GA 006 841-121	1	1x12V21W (PY21W)
		8GA 008 246-001	1	1x12V16W (W16W)
				
Focus		1LE 010 199-031	1	H4 headlight, left
Focus	10/98->09/01	1LE 010 199-041	1	H4 headlight, right
		8GJ 002 525-131	1	Spare Parts: 1x12V60/55W (H4)
		8GD 002 078-121	1	1x12V21/5W (P21/5W)
				





**Ford**

Manufacturer Model	Model year	Part no.	Pk.	Note
Ford				
Focus Focus (-) ST170/RS	10/01->11/04	1LE 010 198-051 1LE 010 198-061 8GH 007 157-121 8GH 002 089-133 8GA 002 073-121 8GP 003 594-121	1 1 1 1 1 1	H1/H7 headlight, left, with indicator light, for vehicles with headlight leveller H1/H7 headlight, right, with indicator light, for vehicles with headlight leveller Spare Parts: 1x12V55W (H7) 1x12V55W (H1) 1x12V21W (P21W) 1x12V5W (W5W)
Focus RS	10/02->11/04	1LE 010 198-091 1LE 010 198-101 8GH 007 157-121 8GH 002 089-133 8GA 006 841-121 8GP 003 594-121	1 1 1 1 1 1	H1/H7 headlight, left, with indicator light H1/H7 headlight, right, with indicator light Spare Parts: 1x12V55W (H7) 1x12V55W (H1) 1x12V21W (PY21W) 1x12V5W (W5W)
Focus ST170	03/02->11/04	1LE 010 198-151 1LE 010 198-161 8GH 007 157-121 8GH 002 089-133 8GA 002 073-121 8GP 003 594-121	1 1 1 1 1 1	H1/H7 headlight, left, with indicator light H1/H7 headlight, right, with indicator light Spare Parts: 1x12V55W (H7) 1x12V55W (H1) 1x12V21W (P21W) 1x12V5W (W5W)
Focus (-) ST170/RS	10/01->11/04	1NA 010 205-011 1NA 010 205-021 8GH 008 358-121	1 1 1	H11 fog light, left H11 fog light, right Accessories: 1x12V55W (H11)
Focus (-) RS	10/98->09/01	9EL 354 059-011 9EL 354 059-021 8GA 002 073-121	1 1 1	Body/lens for indicator light (amber), left Body/lens for indicator light (amber), right Accessories: 1x12V21W (P21W)
Focus (-) RS	10/01->11/04	9EL 354 060-011 9EL 354 060-021 8GA 006 841-121	1 1 1	Body/lens for indicator light (clear), left Body/lens for indicator light (clear), right Accessories: 1x12V21W (PY21W)
Focus	10/98->09/01	9EL 354 056-001 8GP 003 594-121	1 1	Body/lens for auxiliary indicator light (amber) Accessories: 1x12V5W (W5W)



Manufacturer Model	Model year	Part no.	Pk.	Note
Ford				
Focus		9EL 354 058-001	1	Body/lens for auxiliary indicator light (clear)
Focus	10/01->11/04	8GP 003 594-541	1	Accessories: 1x12V5W (WY5W)
				
Focus Hatchback	10/98->11/04	9EL 354 061-011 9EL 354 061-021	1 1	Body/lens for combination rearlight, left Body/lens for combination rearlight, right
		8GA 002 073-121 8GP 003 594-121	1 1	Accessories: 2x12V21W (P21W) 1x12V5W (W5W)
				
Focus Hatchback	10/98->11/04	2NE 354 062-021	1	Rear fog light, right
		8GA 002 073-121	1	Spare Parts: 1x12V21W (P21W)
				
Focus Hatchback	10/98->11/04	2ZR 354 063-011	1	Reversing light, left
		8GA 002 073-121	1	Spare Parts: 1x12V21W (P21W)
				
Focus Sedan	02/99->11/04	9EL 354 057-011 9EL 354 057-021	1 1	Body/lens for combination rearlight, left, with rear fog and reverse light Body/lens for combination rearlight, right, with rear fog and reverse light
		8GA 002 073-121 8GP 003 594-121	1 1	Accessories: 3x12V21W (P21W) 1x12V5W (W5W)
				
Focus Estate	02/99->11/04	9EL 171 556-031 9EL 171 556-041	1 1	Body/lens for combination rearlight, left, with reverse light Body/lens for combination rearlight, right, with rear fog light
		8GA 002 073-121 8GP 003 594-121	1 1	Spare Parts: 2x12V21W (P21W) 1x12V5W (W5W)
				

**Ford**

Manufacturer Model	Model year	Part no.	Pk.	Note
Ford				
Focus II Focus II	11/04->02/08	 1LL 010 201-031 1LL 010 201-041 8GH 007 157-121 8GH 002 089-133 8GP 003 594-121 8GA 006 841-121	1 1 1 1 1 1	H1/H7 headlight, left, with indicator light, with chrome-plated cover, with electric headlight levelling actuator H1/H7 headlight, right, with indicator light, with chrome-plated cover, with electric headlight levelling actuator Spare Parts: 1x12V55W (H7) 1x12V55W (H1) 1x12V5W (W5W) 2x12V21W (PY21W)
Focus II	11/04->02/08	 1LL 010 201-071 1LL 010 201-081 8GH 007 157-121 8GH 002 089-133 8GP 003 594-121 8GA 006 841-121	1 1 1 1 1 1	H1/H7 headlight, left, with indicator light, with black cover, with electric headlight levelling actuator H1/H7 headlight, right, with indicator light, with black cover, with electric headlight levelling actuator Spare Parts: 1x12V55W (H7) 1x12V55W (H1) 1x12V5W (W5W) 2x12V21W (PY21W)
Focus II	11/04->02/08	 1LL 010 201-191 1LL 010 201-201 8GH 007 157-121 8GH 002 089-133 8GP 003 594-121 8GA 006 841-121	1 1 1 1 1 1	H1/H7 headlight, left, with indicator light, with cornering light (AFS), with chrome-plated cover, with electric headlight levelling actuator H1/H7 headlight, right, with indicator light, with cornering light (AFS), with chrome-plated cover, with electric headlight levelling actuator Spare Parts: 1x12V55W (H7) 1x12V55W (H1) 1x12V5W (W5W) 2x12V21W (PY21W)
Focus II	11/04->02/08	 1LL 010 201-231 1LL 010 201-241 8GH 007 157-121 8GH 002 089-133 8GP 003 594-121 8GA 006 841-121	1 1 1 1 1 1	H1/H7 headlight, left, with indicator light, with cornering light (AFS), with black cover, with electric headlight levelling actuator H1/H7 headlight, right, with indicator light, with cornering light (AFS), with black cover, with electric headlight levelling actuator Spare Parts: 1x12V55W (H7) 1x12V55W (H1) 1x12V5W (W5W) 2x12V21W (PY21W)
Focus II (+) Xenon light	11/04->02/08	 1LL 010 201-111 1LL 010 201-121 8GS 009 028-021 8GH 002 089-133 8GA 006 841-121 8GP 003 594-121	1 1 1 1 1 1	Xenon/H1 headlight, left, with indicator light, with chrome-plated cover, with electric headlight levelling actuator, without xenon ballast, without gas discharge bulb, without bulbs Xenon/H1 headlight, right, with indicator light, with chrome-plated cover, with electric headlight levelling actuator, without xenon ballast, without gas discharge bulb, without bulbs Spare Parts: 1x35W (D1S) 1x12V55W (H1) 1x12V21W (PY21W) 1x12V5W (W5W)







Manufacturer Model	Model year	Part no.	Pk.	Note
Ford				
Focus II Focus II (+) Xenon light	11/04->02/08	1LL 010 201-151 1LL 010 201-161 8GS 009 028-021 8GH 002 089-133 8GA 006 841-121 8GP 003 594-121	1 1 1 1 1 1	Xenon/H1 headlight, left, with indicator light, with black cover, with electric headlight levelling actuator, without xenon ballast, without gas discharge bulb, without bulbs Xenon/H1 headlight, right, with indicator light, with black cover, with electric headlight levelling actuator, without xenon ballast, without gas discharge bulb, without bulbs Spare Parts: 1x35W (D1S) 1x12V55W (H1) 1x12V21W (PY21W) 1x12V5W (W5W)
Focus II (-) Titanium	03/08->	1LE 354 257-051 1LE 354 257-061 8GH 007 157-121 8GH 002 089-133 8GP 003 594-121 8GA 006 841-121	1 1 1 1 1	H1/H7 headlight, left, with indicator light, with chrome-plated cover, with electric headlight levelling actuator H1/H7 headlight, right, with indicator light, with chrome-plated cover, with electric headlight levelling actuator Spare Parts: 1x12V55W (H7) 1x12V55W (H1) 1x12V5W (W5W) 2x12V21W (PY21W)
Focus II Titanium	03/08->	1LE 354 257-071 1LE 354 257-081 8GH 007 157-121 8GH 002 089-133 8GP 003 594-121 8GA 006 841-121	1 1 1 1 1	H1/H7 headlight, left, with indicator light, with black cover, with electric headlight levelling actuator H1/H7 headlight, right, with indicator light, with black cover, with electric headlight levelling actuator Spare Parts: 1x12V55W (H7) 1x12V55W (H1) 1x12V5W (W5W) 2x12V21W (PY21W)
Focus II (-) ST	11/04->02/08	1N0 354 016-011 1N0 354 016-021 8GH 008 356-121	1 1 1	H8 fog light, left H8 fog light, right Accessories: 1x12V35W (H8)
Focus II (-) ST	11/04->02/08	2PT 010 177-811 2PT 009 599-011 2PT 009 599-021 8KA 165 959-001	1 1 1 1	LED daytime running light set, 2 LED daytime running lights with harness and covers Spare Parts: LED daytime running light, left LED daytime running light, right Cable set



Ford



Manufacturer Model	Model year	Part no.	Pk.	Note
Ford				
Focus II Focus II (-) ST	03/08->	 9HB 183 460-101 8KA 165 959-001 2PT 010 458-801 2PT 010 458-811 8KB 178 139-002	1 1 1 1 25	Cover set for daytime running light set LEDayFlex with covers, assembly accessories and harness. (The LED daytime running light set is not part of scope of supply) Spare Parts: Harness Accessories: Daytime running light set without side light Daytime running light set with side light Extension lead
Focus II Hatchback	11/04->02/08	 9EL 354 067-011 9EL 354 067-021 8GA 006 841-121 8GP 003 594-121	1 1 1 1	Body/lens for combination rearlight, left Body/lens for combination rearlight, right Accessories: 1x12V21W (PY21W) 1x12V5W (W5W)
Focus II Hatchback	11/04->02/08	 2NE 354 068-021 8GA 002 073-121	1 1	Rear fog light, right Spare Parts: 1x12V21W (P21W)
Focus II Hatchback	11/04->02/08	 2ZR 354 069-011 8GA 002 073-121	1 1	Reversing light, left Spare Parts: 1x12V21W (P21W)
Focus II Hatchback	03/08->	 9EL 354 679-011 9EL 354 679-021 8GA 006 841-121	1 1 1	Body/lens for combination rearlight, left, with rear fog and reverse light Body/lens for combination rearlight, right, with rear fog and reverse light Accessories: 1x12V21W (PR21W) RED 1x12V21W (PR21W) 1x12V21W (PY21W)









Manufacturer Model	Model year	Part no.	Pk.	Note
Ford				
Focus II Focus II Sedan	11/04->02/08	9EL 354 066-011	1	Body/lens for combination rearlight, left, with rear fog and reverse light Body/lens for combination rearlight, right, with rear fog and reverse light Accessories: 1x12V21/4W (P21/4W) 1x12V21W (PY21W) 2x12V21W (P21W)
		9EL 354 066-021	1	
		8GD 004 772-121 8GA 006 841-121 8GA 002 073-121	1 1 1	
Focus II Estate	11/04->02/08	9EL 354 065-011	1	Body/lens for combination rearlight, left, with reverse light Body/lens for combination rearlight, right, with rear fog light Spare Parts: 1x12V21W (PY21W) 1x12V21W (P21W) 1x12V5W (W5W)
		9EL 354 065-021	1	
		8GA 006 841-121 8GA 002 073-121 8GP 003 594-121	1 1 1	
Focus II Estate	03/08->	9EL 354 678-031	1	Body/lens for combination rearlight, left, with reverse light Body/lens for combination rearlight, right, with rear fog light Spare Parts: 1x12V21W (PR21W) RED 1x12V21W (PR21W) 1x12V21W (PY21W)
		9EL 354 678-041	1	
		8GA 006 841-121	1	
Focus II Estate	03/08->	9EL 354 678-071	1	Body/lens for LED combination rearlight, left, with LED tail light and reverse light Body/lens for LED combination rearlight, right, with LED tail light and rear fog light Spare Parts: 1x12V21W (PR21W) RED 1x12V21W (PY21W) 1x12V21W (P21W)
		9EL 354 678-081	1	
		8GA 006 841-121 8GA 002 073-121	1 1	
Focus II Convertible	10/06->	2SD 010 230-011	1	Combination rearlight, left, outer part, with bulbs Combination rearlight, right, outer part, with bulbs Spare Parts: 1x12V21/5W (P21/5W) 1x12V21W (PY21W) 1x12V5W (W5W)
		2SD 010 230-021	1	
		8GD 002 078-121 8GA 006 841-121 8GP 003 594-121	1 1 1	







**Ford**

Manufacturer Model	Model year	Part no.	Pk.	Note	
Ford					
Focus II Focus II Convertible	10/06->		2NR 010 229-011	1	Combination rearlight, left, inner part, with rear fog and reverse light, with bulbs
			2NR 010 229-021	1	Combination rearlight, right, inner part, with rear fog and reverse light, with bulbs
			8GA 002 073-121	1	Spare Parts: 2x12V21W (P21W)
Focus C-MAX Focus C-MAX	10/03->03/07		1LE 270 600-191	1	FF®-H7/FF®-H1 headlight, left, with indicator light, without headlight levelling actuator
			1LE 270 600-201	1	FF®-H7/FF®-H1 headlight, right, with indicator light, without headlight levelling actuator
			8GH 007 157-121	1	Spare Parts: 1x12V55W (H7)
			8GH 002 089-133	1	1x12V55W (H1)
			8GP 003 594-121	1	1x12V5W (W5W)
8GA 006 841-121	1	2x12V21W (PY21W)			
Focus C-MAX	10/03->03/07		1N0 354 016-011	1	H8 fog light, left
			1N0 354 016-021	1	H8 fog light, right
			8GH 008 356-121	1	Accessories: 1x12V35W (H8)
Fusion (JU_) Fusion (JU_)	08/02->11/05		1LD 246 044-231	1	H4 headlight, left, with indicator light, with electric headlight levelling actuator
			1LD 246 044-241	1	H4 headlight, right, with indicator light, with electric headlight levelling actuator
			8GJ 002 525-131	1	Spare Parts: 1x12V60/55W (H4)
			8GA 006 841-121	1	1x12V21W (PY21W)
			8GP 003 594-121	1	1x12V5W (W5W)
Fusion (JU_)	11/05->		1LD 247 026-271	1	H4 headlight, left, with indicator light, with electric headlight levelling actuator
			1LD 247 026-281	1	H4 headlight, right, with indicator light, with electric headlight levelling actuator
			8GJ 002 525-131	1	Accessories: 1x12V60/55W (H4)
			8GA 006 841-121	1	1x12V21W (PY21W)
			8GP 003 594-121	1	1x12V5W (W5W)







Manufacturer Model	Model year	Part no.	Pk.	Note
Ford				
Fusion (JU_)		9EL 354 070-011	1	Body/lens for combination rearlight, left, with rear fog and reverse light
Fusion (JU_)	11/05->	9EL 354 070-021	1	Body/lens for combination rearlight, right, with rear fog and reverse light
		8GA 002 073-121	1	Accessories: 1x12V21W (P21W)
		8GA 006 841-121	1	1x12V21W (PY21W)
		8GP 003 594-121	1	1x12V5W (W5W)
		8GA 008 246-001	1	1x12V16W (W16W)
Galaxy (VX, VY)		9EL 147 073-001	2	Body/lens for auxiliary indicator light (amber)
Galaxy (VX, VY)	03/95->05/06	8GP 003 594-121	1	Accessories: 1x12V5W (W5W)
				
Galaxy (VX, VY)		9EL 147 073-801	1	Body/lens set for auxiliary indicator light (grey)
Galaxy (VX, VY)	03/95->05/06	8GP 003 594-121	1	Accessories: 2x12V5W (W5W)
				
Galaxy (VX, VY)		9EL 962 585-051	1	Body/lens for combination rearlight, left, outer part (grey/red)
Galaxy (VX, VY)	03/95->04/00	9EL 962 586-051	1	Body/lens for combination rearlight, right, outer part (grey/red)
		8GA 002 071-121	1	Accessories: 1x12V5W (R5W)
		8GD 002 078-121	1	1x12V21/5W (P21/5W)
		8GA 002 073-121	1	1x12V21W (P21W)
Galaxy (VX, VY)		9EL 964 483-011	1	Body/lens for combination rearlight, left, outer part (red/white)
Galaxy (VX, VY)	04/00->11/03	9EL 964 484-011	1	Body/lens for combination rearlight, right, outer part (red/white)
		8GA 002 071-121	1	Accessories: 1x12V5W (R5W)
		8GA 002 073-121	1	2x12V21W (P21W)
Galaxy (VX, VY)		9EL 964 479-011	1	Body/lens for combination rearlight, left, inner part (white/red), with rear fog and reverse light
Galaxy (VX, VY)	04/00->11/03	9EL 964 480-011	1	Body/lens for combination rearlight, right, inner part (white/red), with rear fog and reverse light
		8GA 002 073-121	1	Accessories: 4x12V21W (P21W)

**Ford**

Manufacturer Model	Model year	Part no.	Pk.	Note
Ford				
Galaxy Galaxy	05/06->	1LJ 009 250-771 1LJ 009 250-781 8GH 007 157-121 8GH 002 089-133 8GA 006 841-121	1 1 1 1 1	FF®-H7/FF®-H1 headlight, left, with indicator light, with electric headlight levelling actuator, with bulbs FF®-H7/FF®-H1 headlight, right, with indicator light, with electric headlight levelling actuator, with bulbs Spare Parts: 1x12V55W (H7) 1x12V55W (H1) 2x12V21W (PY21W)
				
Galaxy	05/06->	5DV 009 000-001	1	Ballast unit
				
Kuga Kuga	03/08->	1LJ 009 696-731 1LJ 009 696-741 8GH 007 157-121 8GH 002 089-133 8GH 008 417-001 8GP 003 594-121	1 1 1 1 1 1	FF®-H7/FF®-H1 headlight, left, with indicator light, with electric headlight levelling actuator, with bulbs FF®-H7/FF®-H1 headlight, right, with indicator light, with electric headlight levelling actuator, with bulbs Spare Parts: 1x12V55W (H7) 1x12V55W (H1) 1x12V21W (H21W) 1x12V5W (W5W)
				
Kuga	03/08->	5DV 009 000-001	1	Ballast unit
				
Maverick (UDS, UNS) Maverick (UDS, UNS)	02/93->06/96	1LD 962 060-131 1LD 962 060-141 8GJ 002 525-131 8GP 003 594-121	1 1 1 1	H4 headlight, left, for vehicles with or without headlight leveller H4 headlight, right, for vehicles with or without headlight leveller Spare Parts: 1x12V60/55W (H4) 1x12V5W (W5W)
				
Mondeo II Mondeo II (-) ST24, ST200	01/98->11/00	1NL 007 594-031 1NL 007 594-041 8GH 002 090-133	1 1 1	DE®-H3 fog light, left DE®-H3 fog light, right Accessories: 1x12V55W (H3)
				



Manufacturer Model	Model year	Part no.	Pk.	Note
Ford				
Mondeo III Mondeo III	11/00->03/07	 1LF 009 057-031 1LF 009 057-041 8GH 007 157-121 8GH 002 089-133 8GA 006 841-121 8GP 003 594-121	1 1 1 1 1 1	H7/H1 headlight, left, with indicator light, with electric headlight leveller, with headlight levelling actuator H7/H1 headlight, right, with indicator light, with electric headlight leveller, with headlight levelling actuator Spare Parts: 1x12V55W (H7) 1x12V55W (H1) 1x12V21W (PY21W) 1x12V5W (W5W)
Mondeo III (-) Estate	11/00->06/03	 9EL 171 558-011 9EL 171 558-021 8GH 008 417-001 8GD 004 772-121 8GA 002 073-121 8GP 003 594-121	1 1 1 1 1 1	Body/lens for combination rearlight, left, with rear fog and reverse light Body/lens for combination rearlight, right, with rear fog and reverse light Accessories: 1x12V21W (H21W) 1x12V21/4W (P21/4W) 2x12V21W (P21W) 2x12V5W (W5W)
Mondeo III (-) Estate	06/03->05/05	 9EL 171 558-051 9EL 171 558-061 8GH 008 417-001 8GD 004 772-121 8GA 002 073-121 8GP 003 594-121	1 1 1 1 1 1	Body/lens for combination rearlight, left, with rear fog and reverse light Body/lens for combination rearlight, right, with rear fog and reverse light Accessories: 1x12V21W (H21W) 1x12V21/4W (P21/4W) 2x12V21W (P21W) 2x12V5W (W5W)
Mondeo III (-) Estate	05/05->03/07	 9EL 171 558-031 9EL 171 558-041 8GH 008 417-001 8GD 004 772-121 8GA 002 073-121 8GP 003 594-121	1 1 1 1 1 1	Body/lens for combination rearlight, left, with rear fog and reverse light Body/lens for combination rearlight, right, with rear fog and reverse light Accessories: 1x12V21W (H21W) 1x12V21/4W (P21/4W) 2x12V21W (P21W) 2x12V5W (W5W)
Mondeo III Estate	11/00->03/07	 9EL 354 071-011 9EL 354 071-021 8GD 004 772-121 8GA 002 073-121	1 1 1 1	Body/lens for combination rearlight, left, with rear fog and reverse light Body/lens for combination rearlight, right, with rear fog and reverse light Accessories: 1x12V21/4W (P21/4W) 3x12V21W (P21W)

**Ford**

Manufacturer Model	Model year	Part no.	Pk.	Note
Ford				
Mondeo IV Mondeo IV (-) bend lighting	03/07->10/10	1LF 010 541-031 1LF 010 541-041 8GH 007 157-121 8GH 002 089-133 8GA 006 841-121 8GP 003 594-121	1 1 1 1 1 1	H1/H7 headlight, left, with indicator light, with electric headlight levelling actuator H1/H7 headlight, right, with indicator light, with electric headlight levelling actuator Spare Parts: 1x12V55W (H7) 1x12V55W (H1) 1x12V21W (PY21W) 1x12V5W (W5W)
Mondeo IV (+) bend lighting	03/07->10/10	1ZL 010 541-071 1ZL 010 541-081 8GH 007 157-121 8GH 002 089-133 8GA 006 841-121 8GP 003 594-121	1 1 1 1 1 1	H1/H7 headlight, left, with indicator light, with bend lighting, with electric headlight levelling actuator H1/H7 headlight, right, with indicator light, with bend lighting, with electric headlight levelling actuator Spare Parts: 1x12V55W (H7) 2x12V55W (H1) 1x12V21W (PY21W) 1x12V5W (W5W)
Mondeo IV (+) Bi-Xenon light (+) bend lighting	03/07->10/10	1LL 010 541-111 1LL 010 541-121 8GS 009 028-021 8GH 002 089-133 8GA 006 841-121 8GP 003 594-121	1 1 1 1 1 1	Bi-Xenon®/H1 headlight, left, with indicator light, with cornering light, with electric headlight levelling actuator, without xenon ballast, without gas discharge bulb, without bulbs Bi-Xenon®/H1 headlight, right, with indicator light, with cornering light, with electric headlight levelling actuator, without xenon ballast, without gas discharge bulb, without bulbs Spare Parts: 1x35W (D1S) 1x12V55W (H1) 1x12V21W (PY21W) 1x12V5W (W5W)
Mondeo IV Sedan	03/07->10/10	9EL 176 574-011 9EL 176 574-021 8GD 002 078-121 8GA 006 841-121	1 1 1 1	Body/lens for combination rearlight, left, outer part Body/lens for combination rearlight, right, outer part Accessories: 1x12V21/5W (P21/5W) 1x12V21W (PY21W)
Mondeo IV Hatchback	03/07->10/10	9EL 176 575-011 9EL 176 575-021 8GD 002 078-121 8GA 006 841-121	1 1 1 1	Body/lens for combination rearlight, left, outer part Body/lens for combination rearlight, right, outer part Accessories: 1x12V21/5W (P21/5W) 1x12V21W (PY21W)



Manufacturer Model	Model year	Part no.	Pk.	Note
Ford				
Mondeo IV Mondeo IV Hatchback Mondeo IV Sedan	03/07->10/10 03/07->10/10	9EL 176 576-011 9EL 176 576-021 8GD 002 078-121 8GD 004 772-121 8GA 006 841-121	1 1 1 1 1	Body/lens for combination rearlight, left, inner part, with rear fog and reverse light, with bulbs Body/lens for combination rearlight, right, inner part, with rear fog and reverse light, with bulbs Spare Parts: 1x12V21/5W (P21/5W) 1x12V21/4W (P21/4W) 1x12V21W (PY21W)
Mondeo IV Estate	03/07->10/10	9EL 176 577-011 9EL 176 577-021 8GD 002 078-121 8GA 006 841-121	1 1 1 1	Body/lens for combination rearlight, left, outer part Body/lens for combination rearlight, right, outer part Accessories: 1x12V21/5W (P21/5W) 1x12V21W (PY21W)
S-MAX S-MAX	05/06->	1LJ 009 250-771 1LJ 009 250-781 8GH 007 157-121 8GH 002 089-133 8GA 006 841-121	1 1 1 1 1	FF®-H7/FF®-H1 headlight, left, with indicator light, with electric headlight levelling actuator, with bulbs FF®-H7/FF®-H1 headlight, right, with indicator light, with electric headlight levelling actuator, with bulbs Spare Parts: 1x12V55W (H7) 1x12V55W (H1) 2x12V21W (PY21W)
S-MAX	05/06->	5DV 009 000-001	1	Ballast unit
Hyundai				
i30, i30cw i30, i30cw	04/09->	1LL 010 146-031 1LL 010 146-041 8GH 007 157-201 8GH 002 089-133 8GA 006 841-121 8GP 003 594-121	1 1 1 1 1 1	FF®-H7/H1 headlight, left, with indicator light, with electric headlight levelling actuator and bulbs FF®-H7/H1 headlight, right, with indicator light, with electric headlight levelling actuator and bulbs Spare Parts: 1x12V55W (H7) 1x12V55W (H1) 1x12V21W (PY21W) 1x12V5W (W5W)



KIA - Mercedes-Benz



Manufacturer Model	Model year	Part no.	Pk.	Note
KIA				
Cee'd		1LJ 009 547-231	1	FF®-H7/H1 headlight, left, with indicator light, with electric headlight levelling actuator, with bulbs
Cee'd 5-doors	12/06->09/09	1LJ 009 547-241	1	FF®-H7/H1 headlight, right, with indicator light, with electric headlight levelling actuator, with bulbs
Cee'd Estate	09/07->09/09			
Pro Cee'd 3-doors	02/08->09/09			
		8GH 007 157-201	1	Spare Parts: 1x12V55W (H7) Long Life
		8GH 002 089-133	1	1x12V55W (H1)
		8GH 008 417-001	1	1x12V21W (H21W)
		8GP 003 594-121	1	1x12V5W (W5W)
Land Rover				
Freelander II (FA_)		1LF 354 025-111	1	H7 headlight, left, with indicator light, with electric headlight levelling actuator
Freelander II (FA_)	10/06->09/10	1LF 354 025-121	1	H7 headlight, right, with indicator light, with electric headlight levelling actuator
		8GH 007 157-121	1	Spare Parts: 2x12V55W (H7)
		8GA 006 841-121	1	1x12V21W (PY21W)
		8GP 003 594-121	1	1x12V5W (W5W)
Freelander II	10/06->09/10	2SK 354 035-011	1	Combination rearlight, left, with rear fog and reverse light
		2SK 354 035-021	1	Combination rearlight, right, with rear fog and reverse light
		8GD 002 078-121	1	Accessories: 1x12V21/5W (P21/5W)
		8GA 002 073-121	1	2x12V21W (P21W)
		8GA 006 841-121	1	1x12V21W (PY21W)
Freelander II	10/10->	2VA 354 666-011	1	Combination rearlight, left, with rear fog and reverse light, with bulbs
		2VA 354 666-021	1	Combination rearlight, right, with rear fog and reverse light, with bulbs
		8GA 002 073-271	1	Spare Parts: 1x12V21/5W (PR21/5) Long Life 2x12V21W (P21W) Long Life 1x12V21W (PY21W) Silver Vision
Mercedes-Benz				
C-Class (W/S 202)		9EL 150 987-001	1	Body/lens for indicator light (amber), left
C 180 - C 280	03/93->08/96	9EL 150 988-001	1	Body/lens for indicator light (amber), right
(C-Class, W/S 202)		8GA 002 073-121	1	Accessories: 1x12V21W (P21W)



Manufacturer Model	Model year	Part no.	Pk.	Note
Mercedes-Benz				
C-Class (W/S 202) C 180 - C 280 (C-Class, W/S 202)	03/93->03/01	9EL 150 867-001 9EL 150 868-001 8GA 006 841-121	1 1 1	Body/lens for indicator light (white), left Body/lens for indicator light (white), right Accessories: 1x12V21W (PY21W)
				
C 180 - C 280 (C-Class, W 202) up to chassis no. A 406838, F 419816	03/93->05/00	2KA 004 983-011 8GM 002 092-121	4 1	Licence plate light Accessories: 1x12V5W (C5W)
				
C-Class (W/S 203) C 180 - C 320 (C-Class, W 203) Sedan C 180 T - C 320 T 4-matic (C-Class, S 203) Estate	05/00->05/02 03/01->05/02	1NA 007 976-071 1NA 007 976-081 8GH 005 636-121	1 1 1	HB4 fog light, left, with bulb HB4 fog light, right, with bulb Spare Parts: 1x12V51W (HB4)
				
C 180 Kompressor - C 320 4-matic (C-Class, W 203) Sedan C 180 T Kompressor - C 320 T 4-matic (C-Class, S 203) Estate	05/02->02/04 05/02->02/04	1NA 007 976-111 1NA 007 976-121 8GH 005 636-121	1 1 1	HB4 fog light, left, with bulb HB4 fog light, right, with bulb Spare Parts: 1x12V51W (HB4)
				
C 180 Kompressor - C 350 4-matic (C-Class, W 203) Sedan C 180 T Kompressor - C 350 T 4-matic (C-Class, S 203) Estate	03/04-> 03/04->	1NA 007 976-231 1NA 007 976-241 8GH 005 636-121	1 1 1	HB4 fog light, left, with bulb HB4 fog light, right, with bulb Spare Parts: 1x12V51W (HB4)
				



Manufacturer Model	Model year	Part no.	Pk.	Note
Mercedes-Benz				
C-Class (W/S 203)		2VP 008 048-051	1	Combination rearlight, left, with rear fog and reverse light, with side-marker reflex-reflector, with bulbs
C 180 T - C 320 T 4-matic (C-Class, S 203) Estate	03/01->02/04			
		2VP 008 048-061	1	Combination rearlight, right, with rear fog and reverse light, with side-marker reflex-reflector, with bulbs
C 180 T, C 180 Kompressor, C 200 CDI T, C 200 CGI T, C 200 Kompressor T, C 220 CDI T, C 240 T, C 240 4-matic T, C 270 CDI T, C 320 T, C 320 4-matic T, C 32 AMG T	03/01->02/04	8GD 004 772-121	1	Spare Parts: 1x12V21/4W (P21/4W)
		8GA 002 073-121	1	2x12V21W (P21W)
		8GA 006 841-121	1	1x12V21W (PY21W)
Estate				
C-Class Sports Coupé (CL 203)		1NA 007 976-071	1	HB4 fog light, left, with bulb
C 160 - C 320 Kompressor (C-Class, CL 203) Sports Coupé	03/01->05/02	1NA 007 976-081	1	HB4 fog light, right, with bulb
		8GH 005 636-121	1	Spare Parts: 1x12V51W (HB4)
C 160 - C 320 (C-Class, CL 203) Sports Coupé	05/02->02/04	1NA 007 976-111	1	HB4 fog light, left, with bulb
		1NA 007 976-121	1	HB4 fog light, right, with bulb
		8GH 005 636-121	1	Spare Parts: 1x12V51W (HB4)
C 160 - C 320 (C-Class, CL 203) Sports Coupé	03/01->02/04	2VP 008 031-051	1	Combination rearlight, left, with rear fog and reverse light, with bulbs
		2VP 008 031-061	1	Combination rearlight, right, with rear fog and reverse light, with bulbs
C 160 Kompressor, C 180, C 180 Kompressor, C 200 CDI, C 200 Kompressor, C 200 CGI Kompressor, C 220, C 220 CDI, C 230 Kompressor, C 30 CDI AMG, C 32 AMG, C 320	03/01->02/04	8GD 004 772-121	1	Spare Parts: 1x12V21/4W (P21/4W)
		8GA 002 073-121	1	3x12V21W (P21W)



Manufacturer Model	Model year	Part no.	Pk.	Note
Mercedes-Benz				
CLK (C 208) CLK 200 - CLK 430 (CLK, C 208)	06/97->02/03	1NB 007 555-031 1NB 007 555-041 8GH 002 089-133	1 1 1	H1 fog light, left, with bulb H1 fog light, right, with bulb Spare Parts: 1x12V55W (H1)
				
CLK 200 - CLK 430 (CLK, C 208) CLK 200, CLK 230 Kompressor, CLK 320, CLK 430	06/97->02/03	9EL 147 845-021 9EL 147 846-021 8GA 002 071-121 8GA 002 073-121 8GA 006 841-121	1 1 1 1 1	Body/lens for combination rearlight, left, outer part Body/lens for combination rearlight, right, outer part Accessories: 1x12V5W (R5W) 1x12V21W (P21W) 1x12V21W (PY21W)
				
CLK (C 209) CLK 200 - CLK 500 (CLK, C 209)	06/02->05/05	1NA 007 976-111 1NA 007 976-121 8GH 005 636-121	1 1 1	HB4 fog light, left, with bulb HB4 fog light, right, with bulb Spare Parts: 1x12V51W (HB4)
				
CLK 200 - CLK 500 (CLK, C 209) CLK 200 CGI, CLK 240, CLK 270 CDI, CLK 320, CLK 320 CDI, CLK 500, CLK 32 AMG	06/02->05/05	2VP 008 326-051 2VP 008 326-061 8GA 002 071-121 8GD 004 772-121 8GA 002 073-121	1 1 1 1 1	Combination rearlight, left, with rear fog and reverse light, with side-marker reflex-reflector, with bulbs Combination rearlight, right, with rear fog and reverse light, with side-marker reflex-reflector, with bulbs Spare Parts: 1x12V5W (R5W) 1x12V21/4W (P21/4W) 3x12V21W (P21W)
				



Manufacturer Model	Model year	Part no.	Pk.	Note
Mercedes-Benz				
CLS (C 219) CLS 300 - CLS 500 (CLS, C 219) CLS 300, CLS 350, CLS 350 CDI, CLS 350 CGI, CLS 500, CLS 55 AMG, CLS 63 AMG (+) Bi-Xenon light (+) bend lighting	10/04->	1LS 008 821-331 1LS 008 821-341 5DV 008 290-004 5DD 008 319-501 8GS 007 949-101 8GH 007 157-201 8GP 003 594-121	1 1	Bi-Xenon®/H7 headlight, left, with indicator light, with bend lighting, with electric headlight levelling actuator, with xenon ballast, with gas discharge bulb, with bulbs Bi-Xenon®/H7 headlight, right, with indicator light, with bend lighting, with electric headlight levelling actuator, with xenon ballast, with gas discharge bulb, with bulbs Spare Parts: 1 Ballast unit 1 Ignitor, gas discharge bulb 1 1x35W (D2S) 1 1x12V55W (H7) 1 1x12V5W (W5W) 1 1x12V21W (PY21W) Osram Diadem
CLS 300 - CLS 500 (CLS, C 219)	10/04->	5DV 008 290-004	1	Ballast unit
CLS 300 - CLS 500 (CLS, C 219)	10/04->	5DD 008 319-501	1	Ignitor, gas discharge bulb
E-Class (W/S 124) E 420, E 500 (E-Class, W 124) (Also suitable for conversion of E 200 - E 320)	06/93->06/95	1LJ 007 219-371 1LJ 007 219-381 2BA 004 693-031 2BA 004 693-041 9EL 129 615-021 9EL 129 614-021 9AH 144 863-021 9AH 144 864-021 9DE 129 975-021 9DE 129 974-021 8GJ 002 525-131 8GH 002 090-133 8GA 006 841-121 8GP 002 067-121	1 1	H4 headlight, left, with H3 spotlight, with white indicator light, with headlight leveller H4 headlight, right, with H3 spotlight, with white indicator light, with headlight leveller Spare Parts: 1 Indicator light (white), left, with bulb 1 Indicator light (white), right, with bulb 1 Lens for indicator light (white), left 1 Lens for indicator light (white), right 1 Lens retaining rim with lens, left 1 Lens retaining rim with lens, right 1 Reflector for H4 headlight, left 1 Reflector for H4 headlight, right 1 1x12V60/55W (H4) 1 1x12V55W (H3) 1 1x12V21W (PY21W) 1 1x12V4W (T4W)





Manufacturer Model	Model year	Part no.	Pk.	Note
Mercedes-Benz				
E-Class (W/S 124)		2BA 004 693-031	1	Indicator light (white), left, with bulb
E 200 - E 500 (E-Class, W/S 124)	06/93->03/98	2BA 004 693-041	1	Indicator light (white), right, with bulb
Sedan	06/93->06/95			Spare Parts:
Estate	06/93->06/96	9EL 129 615-021	1	Lens, left
		9EL 129 614-021	1	Lens, right
Convertible	06/93->03/98	8GA 006 841-121	1	1x12V21W (PY21W)
Coupé	06/93->06/97			
E 200 - E 500 (E-Class, W/S 124)	06/93->03/98	2VP 004 686-151	1	Combination rearlight (grey/red), left, with rear fog and reverse light
Sedan	06/93->06/95	2VP 004 686-181	1	Combination rearlight (grey/red), right, with rear fog and reverse light
Convertible	06/93->03/98			Spare Parts:
Coupé	06/93->06/97	9EL 129 763-021	1	Lens, left
		9EL 129 762-031	1	Lens, right
		8GA 002 071-131	1	1x12V10W (R10W)
		8GA 002 073-121	1	3x12V21W (P21W)
		8GA 006 841-121	1	1x12V21W (PY21W)
E 200 - E 500 (E-Class, W/S 124) Sedan, Coupé, Convertible	06/93->03/98	2KA 004 983-011	4	Licence plate light
		8GM 002 092-121	1	Accessories: 1x12V5W (C5W)
E-Class (W/S 210)		1L9 007 095-111	1	H7 headlight, left, with indicator light, with headlight leveller, with bulbs
E 200 - E 430 (E-Class, W/S 210)	06/95->06/99	1L9 007 095-121	1	H7 headlight, right, with indicator light, with headlight leveller, with bulbs
E 200, E 200 D, E 200 CDI, E 220 D, E 220 CDI, E 230, E 240, E 250 D, E 280, E 290 Turbo-D, E 300 D, E 300 Turbo-D, E 320, E 420, E 430		9AH 144 231-041	1	Lens retaining rim with double lens, left
		9AH 144 232-041	1	Lens retaining rim with double lens, right
		8GH 007 157-201	1	2x12V55W (H7) Long Life
Sedan	06/95->06/99	8GH 007 643-171	1	1x12V6W (H6W) Long Life
Estate	05/96->06/99			1x12V21W (PY21W) Long Life





Manufacturer Model	Model year	Part no.	Pk.	Note
Mercedes-Benz				
E-Class (W/S 210)		1L9 378 176-001	1	Xenon/H7 headlight, left, with indicator light, with electric headlight levelling actuator, with gas discharge bulb, with bulbs
E 200 - E 430 (E-Class, W/S 210)	06/95->06/99			
E36, E 50, E 55, E 200, E 200 D, E 200 CDI, E 220 D, E 220 CDI, E 230, E 240, E 250 D, E 280, E 290 Turbo-D, E 300 D, E 300 Turbo-D, E 320, E 420, E 430		1L9 378 177-001	1	Xenon/H7 headlight, right, with indicator light, with electric headlight levelling actuator, with gas discharge bulb, with bulbs
Sedan	06/95->06/99	9AH 378 393-001	1	Lens retaining rim with double lens, left
		9AH 378 392-001	1	Lens retaining rim with double lens, right
		5DD 008 319-501	1	Ignitor, gas discharge bulb
		8GS 007 001-121	1	1x35W (D2R)
		8GH 007 157-201	1	1x12V55W (H7) Long Life
Estate	05/96->06/99	8GH 007 643-171	1	1x12V6W (H6W) Long Life
(+) Xenon light		8GA 006 841-121	1	1x12V21W (PY21W)
				
E 200 - E 430 (E-Class, W/S 210)		1L9 378 158-001	1	H7 headlight, left, with indicator light, with pneumatic headlight levelling actuator, with bulbs
E 200, E 200 CDI, E 220 CDI, E 240, E 270 CDI, E 280, E 320, E 320 CDI, E 430	07/99->03/03			
Sedan	07/99->03/02	8GH 007 157-201	1	2x12V55W (H7) Long Life
Estate	07/99->03/03	8GH 007 643-171	1	1x12V6W (H6W) Long Life
		8GA 006 841-121	1	1x12V21W (PY21W)
				
E 200 - E 430 (E-Class, W/S 210)		5DD 008 319-501	1	Ignitor, gas discharge bulb
Sedan	06/95->03/02			
Estate	05/96->03/03			
				





Manufacturer Model	Model year	Part no.	Pk.	Note
Mercedes-Benz				
E-Class (W/S 210)		1NB 007 555-031	1	H1 fog light, left, with bulb
E 200 - E 430 (E-Class, W/S 210)	07/99->03/03	1NB 007 555-041	1	H1 fog light, right, with bulb
Sedan	07/99->03/02			Spare Parts: 1x12V55W (H1)
Estate	07/99->03/03	8GH 002 089-133	1	
				
E-Class (W/S 211)		1LL 008 369-171	1	H7 headlight, left, with indicator light, with electric headlight levelling actuator, with bulbs
E 200 CDI - E 500 (E-Class, W/S 211)	03/02->05/06	1LL 008 369-181	1	H7 headlight, right, with indicator light, with electric headlight levelling actuator, with bulbs
E 200 CDI, E 200 CGI, E 200 Kompressor, E 200 NGT, E 220 CDI, E 240, E 240 4-matic, E 270 CDI, E 280, E 280 CDI, E 320, E 320 4-matic, E 320 CDI, E 350, E 400 CDI, E 420 CDI, E 500, E 500 4-matic, E 55 AMG		8GH 007 157-201	1	Spare Parts: 2x12V55W (H7) Long Life 1x12V5W (W5W) Long Life 1x12V21W (PY21W) Long Life
Sedan	03/02->05/06			
Estate	03/03->05/06			
				







Manufacturer Model	Model year	Part no.	Pk.	Note
Mercedes-Benz				
E-Class (W/S 211)		1LL 008 369-271	1	Bi-Xenon®/H7 headlight, left, with indicator light, with electric headlight levelling actuator, with xenon ballast, with gas discharge bulb, with bulbs
E 200 CDI - E 500 (E-Class, W/S 211)	03/02->05/06			
E 200 CDI, E 200 CGI, E 200 Kompressor, E 200 NGT, E 220 CDI, E 240, E 240 4-matic, E 270 CDI, E 280, E 280 CDI, E 320, E 320 4-matic, E 320 CDI, E 350, E 400 CDI, E 420 CDI, E 500, E 500 4-matic, E 55 AMG		1LL 008 369-281	1	Bi-Xenon®/H7 headlight, right, with indicator light, with electric headlight levelling actuator, with xenon ballast, with gas discharge bulb, with bulbs
Sedan	03/02->05/06	5DV 008 290-004	1	Spare Parts: Ballast unit
Estate	03/03->05/06	5DD 008 319-501	1	Ignitor, gas discharge bulb
		8GS 007 949-101	1	1x35W (D2S)
		8GH 007 157-201	1	1x12V55W (H7) Long Life 1x12V5W (W5W) Long Life 1x12V21W (PY21W) Long Life
(+) Bi-Xenon light (-) bend lighting				
				
E 200 CDI - E 500 (E-Class, W/S 211)		1LS 008 369-491	1	Bi-Xenon®/H7 headlight, left, with indicator light, with bend lighting, with electric headlight levelling actuator, with xenon ballast, with gas discharge bulb, with bulbs
E 200 CDI, E 200 CGI, E 200 Kompressor, E 200 NGT, E 220 CDI, E 240, E 240 4-matic, E 270 CDI, E 280, E 280 CDI, E 320, E 320 4-matic, E 320 CDI, E 350, E 400 CDI, E 420 CDI, E 500, E 500 4-matic, E 55 AMG	03/02->05/06			
Sedan	03/02->05/06	1LS 008 369-501	1	Bi-Xenon®/H7 headlight, right, with indicator light, with bend lighting, with electric headlight levelling actuator, with xenon ballast, with gas discharge bulb, with bulbs
Estate	03/03->05/06	5DV 008 290-004	1	Spare Parts: Ballast unit
		5DD 008 319-501	1	Ignitor, gas discharge bulb
		8GS 007 949-101	1	1x35W (D2S)
		8GH 007 157-121	1	1x12V55W (H7)
		8GP 003 594-121	1	1x12V5W (W5W)
		8GA 006 841-121	1	1x12V21W (PY21W)
(+) Bi-Xenon light (+) bend lighting				
				



Manufacturer Model	Model year	Part no.	Pk.	Note
Mercedes-Benz				
E-Class (W/S 211)				
E 200 K - E 500 (E-Class, W/S 211)	06/06->	1LL 009 260-091	1	H7 headlight, left, with indicator light, with electric headlight levelling actuator, with bulbs
E 220 CDI, E 200 K, E 220 CDI, E 230, E 270 CDI, E 280, E 280 4M, E 280 CDI, E 280 CDI 4M, E 320 CDI, E 320 4M, E 350, E 350 4M, E 500, E 500 4M, E 63 AMG		1LL 009 260-101	1	H7 headlight, right, with indicator light, with electric headlight levelling actuator, with bulbs
		8GH 007 157-121	1	2x12V55W (H7)
		8GP 003 594-121	1	1x12V5W (W5W)
		8GA 006 841-121	1	1x12V21W (PY21W)
Sedan, Estate	06/06->			
				
E 200 K - E 500 (E-Class, W/S 211)	06/06->	1LL 009 260-571	1	Bi-Xenon®/H7 headlight, left, with indicator light, without bend lighting, with electric headlight levelling actuator, without xenon ballast, with gas discharge bulb, with bulbs
E 220 CDI, E 200 K, E 220 CDI, E 230, E 270 CDI, E 280, E 280 4M, E 280 CDI, E 280 CDI 4M, E 320 CDI, E 320 4M, E 350, E 350 4M, E 500, E 500 4M, E 63 AMG		1LL 009 260-581	1	Bi-Xenon®/H7 headlight, right, with indicator light, without bend lighting, with electric headlight levelling actuator, without xenon ballast, with gas discharge bulb, with bulbs
Sedan, Estate	06/06->	5DC 009 060-011	1	Accessories: Ballast unit
(+) Bi-Xenon light (-) bend lighting		8GS 009 028-021	1	Spare Parts: 1x35W (D1S)
		8GH 007 157-121	1	2x12V55W (H7)
		8GA 006 841-121	1	1x12V21W (PY21W)
				





Manufacturer Model	Model year	Part no.	Pk.	Note
Mercedes-Benz				
E-Class (W/S 211)				
E 200 K - E 500 (E-Class, W/S 211)	06/06->	1ZT 009 260-671	1	Bi-Xenon®/H7 headlight, left, with indicator light, with bend lighting, with electric headlight levelling actuator, without xenon ballast, with gas discharge bulb, with bulbs
E 220 CDI, E 200 K, E 220 CDI, E 230, E 270 CDI, E 280, E 280 4M, E 280 CDI, E 280 CDI 4M, E 320 CDI, E 320 4M, E 350, E 350 4M, E 500, E 500 4M, E 63 AMG		1ZT 009 260-681	1	Bi-Xenon®/H7 headlight, right, with indicator light, with bend lighting, with electric headlight levelling actuator, without xenon ballast, with gas discharge bulb, with bulbs
Sedan, Estate	06/06->	5DC 009 060-011	1	Accessories: Ballast unit
(+) Bi-Xenon light (+) bend lighting		8GS 009 028-021 8GH 007 157-121 8GA 006 841-121	1 1 1	Spare Parts: 1x35W (D1S) 2x12V55W (H7) 1x12V21W (PY21W)
				
E 200 CDI - E 500 (E-Class, W/S 211)	03/02->06/06	5DV 008 290-004	1	Ballast unit
Sedan	03/02->06/06			
Estate	03/03->06/06			
				
E 200 CDI - E 500 (E-Class, W/S 211)	03/02->06/06	5DD 008 319-501	1	Ignitor, gas discharge bulb
Sedan	03/02->06/06			
Estate	03/03->06/06			
				
E 200 K - E 500 (E-Class, W/S 211)	06/06->	5DC 009 060-011	1	Ballast unit
Sedan, Estate	06/06->			
				



Manufacturer Model	Model year	Part no.	Pk.	Note
Mercedes-Benz				
E-Class (W/S 211)		1NB 008 275-031	1	H11 fog light, left, with bulb
E 200 CDI - E 500 (E-Class, W/S 211)	03/02->05/04	1NB 008 275-041	1	H11 fog light, right, with bulb
Sedan	03/02->05/04	8GH 008 358-121	1	Spare Parts: 1x12V55W (H11)
Estate	03/03->05/04			
E 200 CDI - E 500 (E-Class, W/S 211)		1NB 008 275-071	1	H11 fog light, left, with bulb
Sedan	06/04->06/06	1NB 008 275-081	1	H11 fog light, right, with bulb
Estate	06/04->06/06	8GH 008 358-121	1	Spare Parts: 1x12V55W (H11)
E-Class (W/S 212)		1LL 010 800-031	1	DE@-H7 headlight, left, with indicator light, with electric headlight levelling actuator, with bulbs
E 200 CDI - E 500 (E-Class, W/S 212)	01/09->	1LL 010 800-041	1	DE@-H7 headlight, right, with indicator light, with electric headlight levelling actuator, with bulbs
E 200 CDI, E 200 CGI, E 220 CDI, E 250 CDI, E 250 CGI, E 350 BlueTec, E 350 4-matic, E 350 CDI, E 350 CDI 4-matic, E 350 CGI, E 500, E 500 4-matic, E 63 AMG		8GH 007 157-121	1	Spare Parts: 2x12V55W (H7) 1x12V5W (W5W) Long Life 1x12V21W (PY21W)
Sedan	01/09->	8GA 006 841-121	1	
Estate	08/09->			







Manufacturer Model	Model year	Part no.	Pk.	Note
Mercedes-Benz				
E-Class (W/S 212)		1ZT 010 800-211	1	Bi-Xenon®/H7-AFS headlight, left, with indicator light, with cornering light, with bend lighting, with electric headlight levelling actuator, without xenon ballast, with gas discharge bulb, with bulbs Bi-Xenon®/H7-AFS headlight, right, with indicator light, with cornering light, with bend lighting, with electric headlight levelling actuator, without xenon ballast, with gas discharge bulb, with bulbs When used in vehicles manufactured ->11/2010 care must be taken during replacement that the Xenon gas discharge lamp is replaced in the headlight still being used, because the new headlight has a 5000K D1S Xenon gas discharge lamp installed. This means the left and right headlights both have the same light colour. Spare Parts: 1x35W (D1S) 5000 K 2x12V55W (H7) 1x12V5W (W5W)
E 200 CDI - E 500 E-Class (W/S 212)	01/09->			
E 200 CDI, E 200 CGI, E 220 CDI, E 250 CDI, E 250 CGI, E 350 BlueTec, E 350 4-matic, E 350 CDI, E 350 CDI 4-matic, E 350 CGI, E 500, E 500 4-matic, E 63 AMG		1ZT 010 800-221	1	
Sedan	01/09->			
Estate	08/09->			
(+) Bi-Xenon light (+) bend lighting				
		8GH 007 157-121 8GP 003 594-121	1 1	
E-Class Coupé/Cabrio (C 207)		1ZT 009 647-351	1	Bi-Xenon®/H7 headlight, left, with LED indicator light, with cornering light, with bend lighting, with electric headlight levelling actuator, without xenon ballast, with gas discharge bulb, with bulbs Bi-Xenon®/H7 headlight, right, with LED indicator light, with cornering light, with bend lighting, with electric headlight levelling actuator, without xenon ballast, with gas discharge bulb, with bulbs Spare Parts: 1x35W (D1S) 2x12V55W (H7) 1x12V5W (W5W)
E 250 CDI - E 500 E-Class Coupé (C 207), E-Class Convertible (A 207)	01/09->			
E 250 CDI, E 250 CGI, E 350 CDI, E 350 CGI, E 500		1ZT 009 647-361	1	
(+) Bi-Xenon light (+) bend lighting				
		8GS 009 028-021 8GH 007 157-121 8GP 003 594-121	1 1 1	
G-Class (W 460)		1L8 003 060-561	1	Headlight, not suitable for headlight leveller Spare Parts: Cap Bulb socket for side light (to be ordered separately) 1x12V45/40W (R2) 1x12V4W (T4W)
230 G - 300 GD (G-Class, W 460)	05/79->08/89			
230 G, 230 GE, 240 GD, 250 GD, 280 GE, 300 GD		9GH 116 966-011 9FF 126 444-001	10 10	
(+) Bi-Xenon light (+) bend lighting		8GD 002 088-131 8GP 002 067-121	1 1	
		1L8 003 060-691	1	H4 headlight, not suitable for headlight leveller Spare Parts: Cap Bulb socket for side light (to be ordered separately) 1x12V60/55W (H4) 1x12V4W (T4W)
		9GH 116 966-011 9FF 126 444-001	10 10	
		8GJ 002 525-131 8GP 002 067-121	1 1	







Manufacturer Model	Model year	Part no.	Pk.	Note
Mercedes-Benz				
G-Class (W 460) 230 G - 300 GD (G-Class, W 460) 230 G, 230 GE, 250 GD, 300 GD	09/89->07/93 09/89->07/93	1L8 004 148-017 1L8 139 474-015 9GH 116 966-011 9FF 126 444-001 8GJ 002 525-131 8GP 002 067-121	120 1 10 10 1 1	H4 headlight, suitable for headlight leveller Spare Parts: Light unit Cap Bulb socket for side light 1x12V60/55W (H4) 1x12V4W (T4W)
230 G - 300 GD (G-Class, W 460)	05/79->03/90	2NE 002 589-047 9EL 112 763-001 8GA 002 073-121	10 5 1	Rear fog light Spare Parts: Lens with screws Accessories: 1x12V21W (P21W)
G-Class (W 461) 230 GE - G 290 TD (G-Class, W 461) 230 GE, 250 GD, 290 GD, 290 GD, G 290 D, G 290 TD	02/90->	1L8 004 148-017 1L8 139 474-015 9GH 116 966-011 9FF 126 444-001 8GJ 002 525-131 8GP 002 067-121	120 1 10 10 1 1	H4 headlight, suitable for headlight leveller Spare Parts: Light unit Cap Bulb socket for side light 1x12V60/55W (H4) 1x12V4W (T4W)
G-Class (W 463) 200 GE - G 55 AMG (G-Class, W 463) 200 GE, 230 GE, 250 GD, G 270 CDI, 300 GD, 300 GE, G 300 TD, G 320, G 320 350 G Turbo D, G 36 AMG, G 400 CDI, G 500, G 500 E, G 55 AMG	09/89->	1L8 004 148-017 1L8 139 474-015 9GH 116 966-011 9FF 126 444-001 8GJ 002 525-131 8GP 002 067-121	120 1 10 10 1 1	H4 headlight, suitable for headlight leveller Spare Parts: Light unit Cap Bulb socket for side light 1x12V60/55W (H4) 1x12V4W (T4W)



Manufacturer Model	Model year	Part no.	Pk.	Note
Mercedes-Benz				
GL-Class (X 164) GL 320 CDI - GL 500 (GL-Class, X 164) up to chassis no. A 296452	09/06->09/07	5DV 008 290-004	1	Ballast unit
				
GL 320 CDI - GL 500 (GL-Class, X 164)	09/06->09/07	5DD 008 319-501	1	Ignitor, gas discharge bulb
				
M-Class (W 163) ML 230 - ML 500 (M-Class, W 163) ML 230, ML 270 CDI, ML 320, ML 350, ML 400 CDI, ML 430, ML 500	09/01->06/05	1LL 223 151-031 1LL 223 151-041 8GH 007 157-121 8GP 003 594-121 8GA 006 841-121	1 1 1 1 1	DE@-H7/FF@-H7 headlight, left, with indicator light, with electric headlight levelling actuator, with bulbs DE@-H7/FF@-H7 headlight, right, with indicator light, with electric headlight levelling actuator, with bulbs Spare Parts: 2x12V55W (H7) 1x12V5W (W5W) 1x12V21W (PY21W)
				
ML 230 - ML 500 (M-Class, W 163)	09/01->06/05	5DV 008 290-004	1	Ballast unit
				
ML 230 - ML 500 (M-Class, W 163)	09/01->06/05	5DD 008 319-501	1	Ignitor, gas discharge bulb
				





Manufacturer Model	Model year	Part no.	Pk.	Note
Mercedes-Benz				
M-Class (W 164)				
ML 280 - ML 500 (M-Class, W 164) ML 280 CDI, ML 300 CDI, ML 320 CDI, ML 350, ML 350 BlueTEC, ML 420 CDI, ML 450 CDI, ML 450 Hybrid, ML 500, ML 63 AMG from chassis no. A 480007	10/08->	1LL 263 064-031 1LL 263 064-041 8GH 007 157-121 8GA 006 841-121 8GP 003 594-121 8GP 003 594-541	1 1 1 1 1	DE®-H7/FF®-H7 headlight, left, with indicator light, with electric headlight levelling actuator DE®-H7/FF®-H7 headlight, right, with indicator light, with electric headlight levelling actuator Spare Parts: 2x12V55W (H7) 1x12V21W (PY21W) 1x12V5W (W5W) 1x12V5W (WY5W)
				
ML 280 - ML 500 (M-Class, W 164) ML 280 CDI, ML 300 CDI, ML 320 CDI, ML 350, ML 350 BlueTEC, ML 420 CDI, ML 450 CDI, ML 450 Hybrid, ML 500, ML 63 AMG from chassis no. A 480007 (+) Bi-Xenon light (+) bend lighting	10/08->	1ZS 263 064-531 1ZS 263 064-541 8GS 009 028-021 8GH 007 157-201 8GP 003 594-121 8GP 003 594-541	1 1 1 1	Bi-Xenon®/FF®-H7 headlight, left, with indicator light, with bend lighting, with electric headlight levelling actuator, without xenon ballast, with gas discharge bulb, with bulbs Bi-Xenon®/FF®-H7 headlight, right, with indicator light, with bend lighting, with electric headlight levelling actuator, without xenon ballast, with gas discharge bulb, with bulbs Spare Parts: 1x35W (D1S) 1x12V55W (H7) 1x12V5W (W5W) 1x12V5W (WY5W)
				
R-Class (W 251, V251)				
R 280 - R 63 AMG (R-Class, W 251, V251)	01/06->07/10	5DV 008 290-004	1	Ballast unit
				
R 280 - R 63 AMG (R-Class, W 251, V251)	01/06->07/10	5DD 008 319-501	1	Ignitor, gas discharge bulb
				



Manufacturer Model	Model year	Part no.	Pk.	Note
Mercedes-Benz				
S-Class Coupé (C 215) CL 55 - CL 600 (S-Class Coupé, C 215) (-) AMG Styling	03/99->09/02	1NA 007 976-071 1NA 007 976-081 8GH 005 636-121	1 1 1	HB4 fog light, left, with bulb HB4 fog light, right, with bulb Spare Parts: 1x12V51W (HB4)
				
CL 55 - CL 600 (S-Class Coupé, C 215) (-) AMG Styling	10/02->03/06	1NA 007 976-111 1NA 007 976-121 8GH 005 636-121	1 1 1	HB4 fog light, left, with bulb HB4 fog light, right, with bulb Spare Parts: 1x12V51W (HB4)
				
SLK (R 170) SLK 200 - SLK 230 (R 170) (+) AMG optic package	06/96->04/04	1NB 007 555-031 1NB 007 555-041 8GH 002 089-133	1 1 1	H1 fog light, left, with bulb H1 fog light, right, with bulb Spare Parts: 1x12V55W (H1)
				
SLK 200 - SLK 230 (R 170) (-) AMG optic package	06/96->04/04	1NA 007 976-071 1NA 007 976-081 8GH 005 636-121	1 1 1	HB4 fog light, left, with bulb HB4 fog light, right, with bulb Spare Parts: 1x12V51W (HB4)
				
SLK (R 171) SLK 200 Kompressor - SLK 55 AMG (R 171) SLK 200 Kompressor SLK 280, SLK 350, SLK 55 AMG	03/04->04/08	2VP 008 427-091 2VP 008 427-101 8GA 002 073-121 8GA 006 841-121	1 1 1 1	Combination rearlight, left, with rear fog and reverse light, with bulbs Combination rearlight, right, with rear fog and reverse light, with bulbs Spare Parts: 2x12V21W (P21W) 1x12V21W (PY21W)
				









Manufacturer Model	Model year	Part no.	Pk.	Note
Mercedes-Benz				
Vaneo (414) Vaneo (414)	02/02->		<p>2VP 008 406-031 1 Combination rearlight, left, with rear fog and reverse light, with bulbs</p> <p>2VP 008 406-041 1 Combination rearlight, right, with rear fog and reverse light, with bulbs</p> <p>Spare Parts:</p> <p>8GA 002 071-121 1 1x12V5W (R5W) 8GD 004 772-121 1 1x12V21/4W (P21/4W) 8GA 002 073-121 1 2x12V21W (P21W) 8GA 006 841-121 1 1x12V21W (PY21W)</p>	
Viano (W 639) Viano (W 639)	09/03->08/10		<p>1LG 246 041-031 1 H7 headlight, left, with indicator light, with H7 fog light, with electric headlight levelling actuator, with bulbs</p> <p>1LG 246 041-041 1 H7 headlight, right, with indicator light, with H7 fog light, with electric headlight levelling actuator, with bulbs</p> <p>Spare Parts:</p> <p>8GH 007 157-121 1 3x12V55W (H7) 8GP 003 594-121 1 1x12V5W (W5W) 8GA 002 073-121 1 1x12V21W (P21W)</p>	
Viano (W 639)	09/10->		<p>1LG 009 627-031 1 FF®-H7 headlight, left, with indicator light, with daytime running light, with H7 fog light, with electric headlight levelling actuator, with bulbs</p> <p>1LG 009 627-041 1 FF®-H7 headlight, right, with indicator light, with daytime running light, with H7 fog light, with electric headlight levelling actuator, with bulbs</p> <p>Spare Parts:</p> <p>8GH 007 157-121 1 3x12V55W (H7) 8GA 006 841-121 1 1x12V21W (PY21W) 8GP 003 594-121 1 1x12V5W (W5W)</p>	
Viano (W 639)	09/03->08/10		<p>2SK 964 596-011 1 Combination rearlight, left, with rear fog and reverse light, with bulbs</p> <p>2SK 964 596-021 1 Combination rearlight, right, with rear fog and reverse light, with bulbs</p> <p>Spare Parts:</p> <p>8GD 002 078-121 1 1x12V21/5W (P21/5W) 8GA 002 073-121 1 2x12V21W (P21W) 8GA 006 841-121 1 1x12V21W (PY21W)</p>	







Manufacturer Model	Model year	Part no.	Pk.	Note
Mercedes-Benz				
190 (W 201)		2BA 004 257-011	1	Indicator light (amber), left
190 (W 201)	10/82->08/93	2BA 004 257-021	1	Indicator light (amber), right
		9EL 127 688-001	1	Spare Parts: Body/lens, right
		9FT 129 176-001	10	Bulb holder
		8GA 002 073-121	1	Accessories: 1x12V21W (P21W)
				
190 (W 201)	10/82->08/93	2BA 004 257-031	1	Indicator light (white), left, with bulb
		2BA 004 257-041	1	Indicator light (white), right, with bulb
		8GA 006 841-121	1	Spare Parts: 1x12V21W (PY21W)
				
190 (W 201)	09/85->08/93	2KA 004 983-011	4	Licence plate light
		8GM 002 092-121	1	Accessories: 1x12V5W (C5W)
				
190 (W 201)	10/82->03/87	2JA 004 252-031	1	Front interior light, with delayed action switch-off
Special equipment		8GM 002 091-131	1	Accessories: 1x12V10W (K)
				
200 - 300 (W 123)				H4 headlight, with H3 fog light, with indicator light, with headlight leveller, only spare parts available
200 - 300 (W 123)	09/79->08/82			
200, 200 D	09/79->08/82			
200 T	06/80->08/82			
230	09/79->06/80	2BA 003 110-011	1	Spare Parts: Indicator light, left
230 E	07/80->08/82	2BA 003 110-021	1	Indicator light, right
230 T	09/79->05/80	9EL 120 651-001	1	Lens for indicator light, left
230 TE	06/80->08/82	9EL 120 652-001	1	Lens for indicator light, right
240 D, 240 TD, 250, 250 T, 300 D, 300 TD	09/79->08/82	9FF 085 642-001	10	Bulb socket for side light
300 TD Turbo-Diesel	09/80->08/82	8GJ 002 525-131	1	Accessories: 1x12V60/55W (H4)
		8GH 002 090-133	1	1x12V55W (H3)
		8GA 002 073-121	1	1x12V21W (P21W)
		8GP 002 067-121	1	1x12V4W (T4W)
				



Manufacturer Model	Model year	Part no.	Pk.	Note
Mercedes-Benz				
200 - 300 (W 123)		2BA 003 110-011	1	Indicator light, left
200 - 300 (W 123)	02/76->12/85	2BA 003 110-021	1	Indicator light, right
		9EL 120 651-001	1	Spare Parts: Lens, left
		9EL 120 652-001	1	Lens, right
		8GA 002 073-121	1	Accessories: 1x12V21W (P21W)
				
200 - 300 (W 123)	02/76->12/85	2VP 003 069-021	1	Combination rearlight, right, with reverse light
200, 200 D	02/76->12/85			Accessories:
220 D	02/76->03/79	8GA 002 071-131	1	1x12V10W (R10W)
230	02/76->06/80	8GA 002 073-121	1	4x12V21W (P21W)
230 C	03/77->06/80			
230 CE, 230 E	07/80->12/85			
240 D, 250	02/76->12/85			
280	02/76->08/82			
280 C	03/77->08/82			
280 CE	03/77->12/85			
280 E, 300 D	02/76->12/85			
				
200 - 300 (W 123)		2KA 003 102-011	4	Licence plate light
Sedan, Coupé	02/76->05/79	8GM 002 092-121	1	Accessories: 1x12V5W (C5W)
Estate	09/77->12/85			
				
200 - 300 (W 123)	02/76->08/82	2JA 003 115-001	2	Interior light
		8GM 002 091-131	1	Accessories: 1x12V10W (K)
				
200 - 300 (W 123)	09/82->12/85	2JA 004 252-031	1	Interior light, with delayed action switch-off
		8GM 002 091-131	1	Accessories: 1x12V10W (K)
				
200 - 500 (W 124)		9EL 129 615-011	1	Body/lens for indicator light (amber), left
200 - 500 (W 124)	12/84->06/93	9EL 129 614-011	1	Body/lens for indicator light (amber), right
		9FT 129 176-001	10	Spare Parts: Bulb holder
		8GA 002 073-121	1	Accessories: 1x12V21W (P21W)
				



Manufacturer Model	Model year	Part no.	Pk.	Note
Mercedes-Benz				
200 - 500 (W 124) 200 - 500 (W 124)	12/84->06/93	 2BA 004 693-801 2BA 004 693-031 2BA 004 693-041 9EL 129 615-021 9EL 129 614-021 8GA 006 841-121	1 1 1 1 1 1	Indicator light set (white), with bulbs Spare Parts: Indicator light (white), left, with bulb Indicator light (white), right, with bulb Body/lens (white), left Body/lens (white), right 2x12V21W (PY21W)
200 - 500 (W 124) 200, 200 D, 200 E, 220 CE, 220 E, 230 CE, 230 E, 250 D, 250 D Turbo, 260 E, 280 E, 300 CE, 300 CE-24, 300 D, 300 D Turbo, 300 E, 300 E-24, 300 TD Turbo, 320 CE, 320 E, 400 E, 500 E Sedan, Convertible, Coupé	12/84->06/93	 2VP 004 686-111 2VP 004 686-141 2VP 004 686-121 9EL 129 763-001 9EL 129 762-001 8GA 002 071-131 8GA 002 073-121	1 1 1 1 1 1 1	Combination rearlight, left, with rear fog and reverse light Combination rearlight, right, with rear fog and reverse light Combination rearlight, right, with reverse light Spare Parts: Lens, left Lens, right Accessories: 1x12V10W (R10W) 4x12V21W (P21W)
200 - 500 (W 124) 200, 200 D, 200 E, 220 CE, 220 E, 230 CE, 230 E, 250 D, 250 D Turbo, 260 E, 280 E, 300 CE, 300 CE-24, 300 D, 300 D Turbo, 300 E, 300 E-24, 300 TD Turbo, 320 CE, 320 E, 400 E, 500 E Sedan, Convertible, Coupé	12/84->06/93	 2VP 004 686-151 2VP 004 686-181 9EL 129 763-021 9EL 129 762-031 8GA 002 071-131 8GA 002 073-121 8GA 006 841-121	1 1 1 1 1 1 1	Combination rearlight (grey/red), left, with rear fog and reverse light Combination rearlight (grey/red), right, with rear fog and reverse light Spare Parts: Lens, left Lens, right Accessories: 1x12V10W (R10W) 3x12V21W (P21W) 1x12V21W (PY21W)
200 - 500 (W 124) Sedan, Convertible, Coupé	12/84->06/93	 2KA 004 983-011 8GM 002 092-121	4 1	Licence plate light Accessories: 1x12V5W (C5W)



Manufacturer Model	Model year	Part no.	Pk.	Note
Nissan				
Navara (D40) Navara (D40)	04/10->	1LE 238 055-031 1LE 238 055-041 8GJ 002 525-131 8GA 006 841-121 8GP 003 594-121	1 1 1 1 1	H4 headlight, left, with indicator light, with electric headlight levelling actuator, with bulbs H4 headlight, right, with indicator light, with electric headlight levelling actuator, with bulbs Spare Parts: 1x12V55W (H4) 1x12V21W (PY21W) 1x12V5W (W5W)
Pathfinder (R51) Pathfinder (R51)	04/10->	1LE 238 055-031 1LE 238 055-041 8GJ 002 525-131 8GA 006 841-121 8GP 003 594-121	1 1 1 1 1	H4 headlight, left, with indicator light, with electric headlight levelling actuator, with bulbs H4 headlight, right, with indicator light, with electric headlight levelling actuator, with bulbs Spare Parts: 1x12V55W (H4) 1x12V21W (PY21W) 1x12V5W (W5W)
Qashqai (J10, JJ10) Qashqai (J10, JJ10)	02/07->01/10	 1LF 238 042-031 1LF 238 042-041 8GH 007 157-121 8GA 006 841-121 8GP 003 594-121	1 1 1 1 1	DE@-H7/FF@-H7 headlight, left, with indicator light, with electric headlight levelling actuator, with bulbs DE@-H7/FF@-H7 headlight, right, with indicator light, with electric headlight levelling actuator, with bulbs Spare Parts: 2x12V55W (H7) 1x12V21W (PY21W) 1x12V5W (W5W)
Qashqai (J10, JJ10) (+) Xenon light	02/07->01/10	 1LF 238 042-131 1LF 238 042-141 5DV 008 290-004 5DD 008 319-501 8GS 007 001-121 8GH 007 157-121 8GP 003 594-121 8GA 006 841-121	1 1 1 1 1 1 1 1	Xenon/H7 headlight, left, with indicator light, with electric headlight levelling actuator, with xenon ballast, with gas discharge bulb, with bulbs Xenon/H7 headlight, right, with indicator light, with electric headlight levelling actuator, with xenon ballast, with gas discharge bulb, with bulbs Spare Parts: Ballast unit Ignitor, gas discharge bulb 1x35W (D2R) 1x12V55W (H7) 1x12V5W (W5W) 1x12V21W (PY21W)
Qashqai (J10, JJ10)	02/07->01/10		1	Ballast unit







Nissan - Opel



Manufacturer Model	Model year	Part no.	Pk.	Note
Nissan				
Qashqai (J10, JJ10) Qashqai (J10, JJ10)	02/07->01/10	5DD 008 319-501	1	Ignitor, gas discharge bulb
				
Qashqai (J10, JJ10)	01/10->	1LL 010 335-071 1LL 010 335-081	1 1	DE@-H7/FF@-H7 headlight, left, with indicator light, with electric headlight levelling actuator, with bulbs DE@-H7/FF@-H7 headlight, right, with indicator light, with electric headlight levelling actuator, with bulbs
		8GH 007 157-201 8GH 007 157-121 8GA 006 841-121 8GP 003 594-121	1 1 1 1	Spare Parts: 1x12V55W (H7) Long Life 1x12V55W (H7) 1x12V21W (PY21W) 1x12V5W (W5W)
Terrano II (R20) Terrano II (R20)	10/92->06/96	1LD 962 060-131 1LD 962 060-141	1 1	H4 headlight, left, for vehicles with or without headlight leveller H4 headlight, right, for vehicles with or without headlight leveller
		8GJ 002 525-131 8GP 003 594-121	1 1	Accessories: 1x12V60/55W (H4) 1x12V5W (W5W)
Terrano II (R20)	09/99->03/05	2BA 964 255-011 2BA 964 255-021	1 1	Indicator light (black), left, with bulb Indicator light (black), right, with bulb
		8GA 006 841-121	1	Spare Parts: 1x12V21W (PY21W)
Terrano II (R20)	09/99->03/05	2BA 964 255-031 2BA 964 255-041	1 1	Indicator light (chrome-plated), left, with bulb Indicator light (chrome-plated), right, with bulb
		8GA 006 841-121	1	Spare Parts: 1x12V21W (PY21W)
Opel				
Astra F Astra F GSi	09/91->01/98	1NL 006 580-051 1NL 006 580-061	1 1	DE@-H3 fog light, left DE@-H3 fog light, right
		8GH 002 090-133	1	Accessories: 1x12V55W (H3)



Manufacturer Model	Model year	Part no.	Pk.	Note
Opel				
Astra F Astra F	09/91->08/94	2BM 003 563-111 8GP 003 594-121	1 1	Auxiliary indicator light Accessories: 1x12V5W (W5W)
				
Astra G Astra G (-) Convertible, Coupé	02/98->04/05	1LG 007 640-331 1LG 007 640-341 6NM 007 878-351 8GH 005 635-121 8GH 007 157-121 8GA 006 841-121 8GP 003 594-121	1 1 1 1 1 1 1	FF®-H7/HB3 headlight, left, with body/lens for indicator light FF®-H7/HB3 headlight, right, with body/lens for indicator light Accessories: Headlight levelling actuator Spare Parts: 1x12V60W (HB3) 1x12V55W (H7) 1x12V21W (PY21W) 1x12V5W (W5W)
				
Astra G, CC, Estate Box Code LU from chassis no. 32000001, 35000001, 38000001, 4G000001	02/98->04/05	1LG 007 640-631 1LG 007 640-641 6NM 007 878-351	1 1 1	FF®-H7/HB3 headlight, left, with body/lens for indicator light and black frame behind the cover lens FF®-H7/HB3 headlight, right, with body/lens for indicator light and black frame behind the cover lens Accessories: Headlight levelling actuator
Astra G Coupé from chassis no. 1B016531	03/00->05/05	8GH 005 635-121 8GH 007 157-121 8GA 006 841-121 8GP 003 594-121	1 1 1 1	Spare Parts: 1x12V60W (HB3) 1x12V55W (H7) 1x12V21W (PY21W) 1x12V5W (W5W)
Astra G Convertible from chassis no. 1B001424	03/01->10/05		1	
				
Astra G	02/98->10/05	6NM 007 878-351	1	Headlight levelling actuator
				
Astra G (-) Convertible, Coupé, OPC	02/98->04/05	1NA 009 029-011 1NA 009 029-021 8GH 002 090-133	1 1 1	FF®-H3 fog light, left, with bulb FF®-H3 fog light, right, with bulb Spare Parts: 1x12V55W (H3)
				



Opel



Manufacturer Model	Model year	Part no.	Pk.	Note
Opel				
Astra G Astra G Hatchback	03/98->01/05	2VP 008 863-801 2SA 008 405-021 2XA 008 221-021 2BA 008 221-041 2ZR 008 221-051 2NE 008 221-031 8RA 008 405-001 8GA 002 073-121 8GA 006 841-121	1	Design combination rearlight set with LED tail light, with 8 module lights, 2 circular ring reflector modules, 2 retaining parts, lead groups and accessories Spare Parts: 1 LED rear light 1 Stop light 1 Indicator light (grey) 1 Reverse light (grey) 1 Rear fog light 1 Reflex-reflector (red) Accessories: 1 6x12V21W (P21W) 1 2x12V21W (PY21W)
Astra H Astra H Code GU	03/04->	1LG 270 370-331 1LG 270 370-341 8GH 007 157-121 8GH 002 089-133 8GH 008 417-001 8GP 003 594-121	1 1	FF®-H7/H1 headlight, left, with integrated indicator light, with electric headlight levelling actuator FF®-H7/H1 headlight, right, with integrated indicator light, with electric headlight levelling actuator Spare Parts: 1 1x12V55W (H7) 1 1x12V55W (H1) 1 1x12V21W (H21W) 1 1x12V5W (W5W)
Astra H Code NA	02/07->	1LG 270 370-631 1LG 270 370-641 8GH 007 157-121 8GH 002 089-133 8GH 008 417-001 8GP 003 594-121	1 1	FF®-H7/H1 headlight, left, with integrated indicator light, with electric headlight levelling actuator FF®-H7/H1 headlight, right, with integrated indicator light, with electric headlight levelling actuator Spare Parts: 1 1x12V55W (H7) 1 1x12V55W (H1) 1 1x12V21W (H21W) 1 1x12V5W (W5W)
Astra H	03/04->	5DV 008 290-004	1	Ballast unit
Astra H	03/04->	5DD 008 319-501	1	Ignitor, gas discharge bulb







Manufacturer Model	Model year	Part no.	Pk.	Note
Opel				
Astra H		1NA 010 503-011	1	FF®-H3 fog light, left, with bulb
Astra H	03/04->	1NA 010 503-021	1	FF®-H3 fog light, right, with bulb
up to chassis no. 72094718, 75086479, 78048187		8GH 002 090-133	1	Spare Parts: 1x12V55W (H3)
(-) OPC				
Astra H Hatchback 5-doors	03/04->01/07	2PT 009 305-821	1	Daytime running light set, 2 daytime running lights with bulbs, with harness and covers
Astra H Estate	08/04->01/07	2PT 008 935-001	1	Spare Parts: Daytime running light
(-) OPC				
Astra H Hatchback 5-doors	03/04->02/07	9EL 160 467-011	1	Body/lens for combination rearlight, left, with rear fog and reverse light
		9EL 160 468-011	1	Body/lens for combination rearlight, right, with rear fog and reverse light
up to chassis no. 72094718, 75086479, 78048187		8GA 006 841-121	1	Accessories: 1x12V21W (PY21W)
		8GA 002 073-121	1	4x12V21W (P21W)
				
Astra H Hatchback 5-doors	03/07->	9EL 354 073-011	1	Body/lens for combination rearlight, left, with rear fog and reverse light
		9EL 354 073-021	1	Body/lens for combination rearlight, right, with rear fog and reverse light
from chassis no. 72094719, 75086480, 78048188, 8B000001		8GA 006 841-121	1	Accessories: 1x12V21W (PY21W)
		8GA 002 073-121	1	4x12V21W (P21W)
				







Opel



Manufacturer Model	Model year	Part no.	Pk.	Note
Opel				
Astra H Astra H GTC 3-doors	03/05->	9EL 161 421-011 9EL 161 422-011 8GA 006 841-121 8GA 002 073-121	1 1 1 1	Body/lens for combination rearlight, left, with rear fog and reverse light Body/lens for combination rearlight, right, with rear fog and reverse light Accessories: 1x12V21W (PY21W) 2x12V21W (P21W)
				
Astra H GTC 3-doors	03/05->	2SK 008 748-801 8GA 002 073-121 8GA 006 841-121 8GA 002 073-121	1 1 1 1	Upgrade combination rearlight set (Icegrey) Accessories: 1x12V21W (P21W) 1x12V21W (PY21W) 3x12V21W (P21W)
				
Astra J Astra J Code AC5 (-) Sport, SRI	12/09->	1LG 010 011-331 1LG 010 011-341 8GH 007 157-201 8GD 008 893-002	1 1 1 1	FF®-H7 headlight, left, with daytime running light, with chrome-plated cover, with electric headlight levelling actuator, with bulbs FF®-H7 headlight, right, with daytime running light, with chrome-plated cover, with electric headlight levelling actuator, with bulbs Spare Parts: 2x12V55W (H7) Long Life 1x12V21/5W (W21/5W)
				
Astra J Sport, SRI Code AB3	12/09->	1LG 010 011-391 1LG 010 011-401 8GH 007 157-201 8GD 008 893-002	1 1 1 1	FF®-H7 headlight, left, with daytime running light, with black cover, with electric headlight levelling actuator, with bulbs FF®-H7 headlight, right, with daytime running light, with black cover, with electric headlight levelling actuator, with bulbs Spare Parts: 2x12V55W (H7) Long Life 1x12V21/5W (W21/5W)
				



Manufacturer Model	Model year	Part no.	Pk.	Note
Opel				
Astra J Astra J (+) Bi-Xenon light (+) bend lighting	12/09->	1ZT 010 012-411	1	Bi-Xenon®/FF®-H11 headlight, left, with daytime running light, with dynamic bend lighting, with dynamic headlight levelling actuator, without xenon ballast, without gas discharge bulb, without bulb
		1ZT 010 012-421	1	Bi-Xenon®/FF®-H11 headlight, right, with daytime running light, with dynamic bend lighting, with dynamic headlight levelling actuator, without xenon ballast, without gas discharge bulb, without bulb
		8GS 009 028-021	1	Accessories: 1x35W (D1S)
		8GH 008 358-121	1	1x12V55W (H11)
Combo II Combo II up to chassis no. 33999999, 34999999, 36999999	10/01->	1NA 009 031-011	1	FF®-H3 fog light, left, with bulb
		1NA 009 031-021	1	FF®-H3 fog light, right, with bulb
		8GH 002 090-133	1	Spare Parts: 1x12V55W (H3)
Corsa C Corsa C up to chassis no. 33999999, 34999999, 36999999	10/00->	1NA 009 031-011	1	FF®-H3 fog light, left, with bulb
		1NA 009 031-021	1	FF®-H3 fog light, right, with bulb
		8GH 002 090-133	1	Spare Parts: 1x12V55W (H3)
Insignia Insignia Code NR	07/08->	1LJ 009 630-331	1	FF®-H7/H1 headlight, left, with indicator light, with daytime running light, with electric headlight levelling actuator, with bulbs
		1LJ 009 630-341	1	FF®-H7/H1 headlight, right, with indicator light, with daytime running light, with electric headlight levelling actuator, with bulbs
		8GH 007 157-121	1	Spare Parts: 1x12V55W (H7)
		8GH 002 089-133	1	1x12V55W (H1)
		8GA 006 841-121	1	1x12V21W (PY21W)
		8GD 008 893-002	1	1x12V21/5W (W21/5W)



Opel



Manufacturer Model	Model year	Part no.	Pk.	Note
Opel				
Insignia Insignia (+) Bi-Xenon light (+) bend lighting	07/08->	1ZT 009 631-311	1	Bi-Xenon®/H11 headlight, left, with indicator light, with daytime running light, with dynamic bend lighting, with electric headlight levelling actuator, without xenon ballast, without gas discharge bulb, with bulbs Bi-Xenon®/H11 headlight, right, with indicator light, with daytime running light, with dynamic bend lighting, with electric headlight levelling actuator, without xenon ballast, without gas discharge bulb, with bulbs Accessories: 1x35W (D1S) Spare Parts: 1x12V55W (H11) 1x12V21W (PY21W)
		1ZT 009 631-321	1	
		8GS 009 028-021	1	
		8GH 008 358-121 8GA 006 841-121	1 1	
Insignia Sports Tourer	07/08->	9EL 354 668-031	1	Body/lens for combination rearlight, left, with reverse light Body/lens for combination rearlight, right, with rear fog light Accessories: 1x12V5W (W5W) 1x12V21W (P21W) 1x12V21W (PY21W) 2x12V21W (H21W)
		9EL 354 668-041	1	
Kadett E Kadett E	10/85->08/91	2BM 003 563-111	1	Auxiliary indicator light Accessories: 1x12V5W (W5W)
		8GP 003 594-121	1	
Kadett E Hatchback, Sedan	09/84->08/91	2KA 003 485-021	1	Licence plate light with bulb Accessories: 1x12V10W (R10W)
		8GA 002 071-131	1	
Kadett E Estate	09/84->08/91	2KA 004 434-031	1	Licence plate light Accessories: 1x12V4W (T4W)
		8GP 002 067-121	1	
Omega A Omega A up to chassis no. L1999999	09/86->09/90	2BA 006 091-011	1	Indicator light, left Indicator light, right Accessories: 1x12V21W (P21W)
		2BA 006 091-021	1	
		8GA 002 073-121	1	







Manufacturer Model	Model year	Part no.	Pk.	Note
Opel				
Omega A Omega A from chassis no. M1000001	10/90->05/94	2BA 007 249-011 2BA 007 249-021 8GA 002 073-121	1 1 1	Indicator light, left Indicator light, right Accessories: 1x12V21W (P21W)
				
Omega A	09/86->05/94	2BM 003 563-111 8GP 003 594-121	1 1	Auxiliary indicator light Accessories: 1x12V5W (W5W)
				
Omega B Omega B Code YX up to chassis no. V1991158	03/94->08/97	1LG 006 920-231 1LG 006 920-241 6NM 007 282-641 8GH 002 089-133 8GA 006 841-121 8GP 003 594-121	1 1 1 1 1 1	H1 headlight, left, with indicator light, suitable for electric headlight leveller H1 headlight, right, with indicator light, suitable for electric headlight leveller Accessories: Headlight levelling actuator Spare Parts: 2x12V55W (H1) UV-Cut 1x12V21W (PY21W) 1x12V5W (W5W)
				
Omega B Code FN from chassis no. 21000001	10/99->07/03	1LL 009 020-231 1LL 009 020-241 6NM 007 282-641 8GH 002 089-133 8GH 007 157-121 8GA 006 841-121 8GP 003 594-121	1 1 1 1 1 1	DE@-H1/H7 headlight, left, with body/lens for indicator light DE@-H1/H7 headlight, right, with body/lens for indicator light Accessories: Headlight levelling actuator Spare Parts: 1x12V55W (H1) 1x12V55W (H7) 1x12V21W (PY21W) 1x12V5W (W5W)
				
Omega B	03/94->07/03	6NM 007 282-641	1	Headlight levelling actuator (for halogen headlight)
				
Omega B	09/97->07/03	5DV 007 760-651	1	Ballast unit
				



Opel



Manufacturer Model	Model year	Part no.	Pk.	Note
Opel				
Omega B		9EL 143 579-021	1	Body/lens for combination rearlight, left, with rear fog and reverse light
Omega B Estate	03/94->09/99	9EL 143 580-021	1	Body/lens for combination rearlight, right, with rear fog and reverse light
up to chassis no. X1999999		8GD 004 772-121	1	Accessories: 1x12V21/4W (P21/4W)
		8GA 006 841-121	1	1x12V21W (PY21W)
		8GA 002 073-121	1	2x12V21W (P21W)
Omega B Estate	03/94->09/99	8RA 007 051-031	1	Reflex-reflector, left
		8RA 007 051-041	1	Reflex-reflector, right
Omega B Estate	10/99->07/03	9EL 152 051-011	1	Body/lens for combination rearlight, left, (red/white), with rear fog and reverse light
from chassis no. Y1000001		9EL 152 052-011	1	Body/lens for combination rearlight, right, (red/white), with rear fog and reverse light
		8GD 004 772-121	1	Accessories: 1x12V21/4W (P21/4W)
		8GA 006 841-121	1	1x12V21W (PY21W)
		8GA 002 073-121	1	2x12V21W (P21W)
Signum		1LL 008 320-251	1	DE@-H7/FF@-H7 headlight, left, with indicator light, suitable for headlight leveller
Signum	05/03->08/05	1LL 008 320-261	1	DE@-H7/FF@-H7 headlight, right, with indicator light, suitable for headlight leveller
Code GB, BJ		8GH 007 157-121	1	Spare Parts: 2x12V55W (H7)
up to chassis no. 51999999		8GP 003 594-121	1	1x12V5W (W5W)
		8GA 006 841-121	1	1x12V21W (PY21W)



Manufacturer Model	Model year	Part no.	Pk.	Note
Opel				
Signum Signum Code GH, BL up to chassis no. 51999999	05/03->08/05	1LL 008 320-331 1LL 008 320-341 8GH 007 157-121 8GP 003 594-121 8GA 006 841-121	1 1 1 1 1	DE@-H7/FF@-H7 headlight (black), left, with indicator light, suitable for headlight leveller DE@-H7/FF@-H7 headlight (black), right, with indicator light, suitable for headlight leveller Spare Parts: 2x12V55W (H7) 1x12V5W (W5W) 1x12V21W (PY21W)
				
Vectra A Vectra A from chassis no. R1000001, R5000001, R7000001	09/93->11/95	9EL 146 021-001 8GA 002 073-121	1 1	Body/lens for indicator light (white), left Accessories: 1x12V21W (P21W)
				
Vectra A	04/88->11/95	2BM 003 563-111 8GP 003 594-121	1 1	Auxiliary indicator light Accessories: 1x12V5W (W5W)
				
Vectra C Vectra C Code GB, BJ up to chassis no. 51999999, 58999999	04/02->08/05	1LL 008 320-251 1LL 008 320-261 8GH 007 157-121 8GP 003 594-121 8GA 006 841-121	1 1 1 1 1	DE@-H7/FF@-H7 headlight, left, with indicator light, suitable for headlight leveller DE@-H7/FF@-H7 headlight, right, with indicator light, suitable for headlight leveller Spare Parts: 2x12V55W (H7) 1x12V5W (W5W) 1x12V21W (PY21W)
				







Opel



Manufacturer Model	Model year	Part no.	Pk.	Note
Opel				
Vectra C Vectra C up to chassis no. 51999999, 58999999	04/02->08/05	1LL 008 320-331 1LL 008 320-341 8GH 007 157-121 8GP 003 594-121 8GA 006 841-121	1 1 1 1 1	DE®-H7/FF®-H7 headlight (black), left, with indicator light, suitable for headlight leveller, for conversion DE®-H7/FF®-H7 headlight (black), right, with indicator light, suitable for headlight leveller, for conversion Spare Parts: 2x12V55W (H7) 1x12V5W (W5W) 1x12V21W (PY21W)
Vectra C up to chassis no. 51999999, 58999999	04/02->08/05	1LL 008 320-331 1LL 008 320-341 8GH 007 157-121 8GP 003 594-121 8GA 006 841-121	1 1 1 1 1	DE®-H7/FF®-H7 headlight (black), left, with indicator light, suitable for headlight leveller DE®-H7/FF®-H7 headlight (black), right, with indicator light, suitable for headlight leveller Spare Parts: 2x12V55W (H7) 1x12V5W (W5W) 1x12V21W (PY21W)
Zafira A (F75_) Zafira A (F75_) (-) GSi, OPC	04/99->06/05	1NA 009 033-011 1NA 009 033-021 8GH 002 090-133	1 1 1	FF®-H3 fog light, left, with bulb FF®-H3 fog light, right, with bulb Spare Parts: 1x12V55W (H3)
Zafira B Zafira B up to chassis no. 72095156, 7G066981 (-) OPC	07/05->	1NA 010 503-011 1NA 010 503-021 8GH 002 090-133	1 1 1	FF®-H3 fog light, left, with bulb FF®-H3 fog light, right, with bulb Spare Parts: 1x12V55W (H3)





Manufacturer Model	Model year	Part no.	Pk.	Note
Peugeot				
107 107	06/05->	 2SK 010 133-801 8GD 002 078-121 8GA 002 073-121	1 1 1	Upgrade combination rearlight set (brilliant silver) Accessories: 2x12V21/5W (P21/5W) 4x12V21W (P21W)
207 207 (WA_, WC_) (-) CC	02/06->08/09	 2VP 354 038-011 2VP 354 038-021 8GA 006 841-121 8GA 002 073-121 8GP 003 594-121	1 1 1 1 1 1	Combination rearlight, left, with rear fog and reverse light Combination rearlight, right, with rear fog and reverse light Accessories: 1x12V21W (PY21W) 3x12V21W (P21W) 1x12V5W (W5W)
207 (WA_, WC_) (-) CC	08/09->	 2VA 354 673-011 2VA 354 673-021 8GA 006 841-121 8GA 002 073-271 8GA 002 071-131	1 1 1 1 1	Combination rearlight, left, with LED tail light, with rear fog and reverse light Combination rearlight, right, with LED tail light, with rear fog and reverse light Accessories: 1x12V21W (PY21W) 2x12V21W (P21W) Long Life 1x12V10W (R10W)
207 CC (WD_)	02/07->08/09	 2VP 354 039-011 2VP 354 039-021 8GA 006 841-121 8GA 002 073-121 8GP 003 594-121	1 1 1 1 1	Combination rearlight, left, with rear fog and reverse light Combination rearlight, right, with rear fog and reverse light Accessories: 1x12V21W (PY21W) 3x12V21W (P21W) 1x12V5W (W5W)





Peugeot - Puch



Manufacturer Model	Model year	Part no.	Pk.	Note	
Peugeot					
207 207 SW (WK_)	06/07->		2VP 354 677-011	1	Combination rearlight, left, with rear fog and reverse light, with bulbs
			2VP 354 677-021	1	Combination rearlight, right, with rear fog and reverse light, with bulbs
			8GA 006 841-121	1	1x12V21W (PY21W)
			8GA 002 073-121	1	3x12V21W (P21W)
			8GP 003 594-121	1	1x12V5W (W5W)
Spare Parts:					
					1x12V21W (PY21W)
					3x12V21W (P21W)
					1x12V5W (W5W)
Partner (5F, 5) Partner (5F, 5)	11/02->		1LG 010 196-031	1	H4 headlight, left, with indicator light, with electric headlight levelling actuator
			1LG 010 196-041	1	H4 headlight, right, with indicator light, with electric headlight levelling actuator
			8GJ 002 525-131	1	1x12V60/55W (H4)
			8GA 006 841-121	1	1x12V21W (PY21W)
			8GP 003 594-121	1	1x12V5W (W5W)
Spare Parts:					
					1x12V60/55W (H4)
					1x12V21W (PY21W)
					1x12V5W (W5W)
Puch					
G-Class (W 460) 230 G - 300 GD (G-Class, W 460)	05/79->08/89		1L8 003 060-561	1	Headlight, not suitable for headlight leveller
			9GH 116 966-011	10	Cap
			9FF 126 444-001	10	Bulb socket for side light (to be ordered separately)
			8GD 002 088-131	1	1x12V45/40W (R2)
			8GP 002 067-121	1	1x12V4W (T4W)
			1L8 003 060-691	1	H4 headlight, not suitable for headlight leveller
			9GH 116 966-011	10	Cap
			9FF 126 444-001	10	Bulb socket for side light (to be ordered separately)
			8GJ 002 525-131	1	1x12V60/55W (H4)
			8GP 002 067-121	1	1x12V4W (T4W)
230 G - 300 GD (G-Class, W 460)	09/89->07/93		1L8 004 148-017	120	H4 headlight, suitable for headlight leveller
230 G, 230 GE, 250 GD, 300 GD	09/89->07/93		1L8 139 474-015	1	Light unit
			9GH 116 966-011	10	Cap
			9FF 126 444-001	10	Bulb socket for side light
			8GJ 002 525-131	1	1x12V60/55W (H4)
			8GP 002 067-121	1	1x12V4W (T4W)

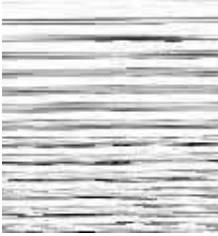
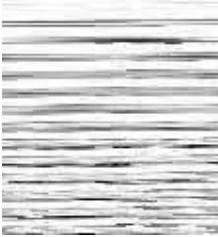

Manufacturer Model	Model year	Part no.	Pk.	Note
Puch				
G-Class (W 460) 230 G - 300 GD (G-Class, W 460)	05/79->03/90	2NE 002 589-047 9EL 112 763-001 8GA 002 073-121	10 5 1	Rear fog light Spare Parts: Lens with screws Accessories: 1x12V21W (P21W)
				
G-Class (W 461) 230 GE - G 290 TD (G-Class, W 461) 230 GE, 250 GD, 290 GD, 290 GD, G 290 D, G 290 TD	02/90->	1L8 004 148-017 1L8 139 474-015 9GH 116 966-011 9FF 126 444-001 8GJ 002 525-131 8GP 002 067-121	120 1 10 10 1 1	H4 headlight, suitable for headlight leveller Spare Parts: Light unit Cap Bulb socket for side light 1x12V60/55W (H4) 1x12V4W (T4W)
				
G-Class (W 463) 200 GE - G 55 AMG (G-Class, W 463) 200 GE, 230 GE, 250 GD, G 270 CDI, 300 GD, 300 GE, G 300 TD, G 320, G 320 350 G Turbo D, G 36 AMG, G 400 CDI, G 500, G 500 E, G 55 AMG	09/89->	1L8 004 148-017 1L8 139 474-015 9GH 116 966-011 9FF 126 444-001 8GJ 002 525-131 8GP 002 067-121	120 1 10 10 1 1	H4 headlight, suitable for headlight leveller Spare Parts: Light unit Cap Bulb socket for side light 1x12V60/55W (H4) 1x12V4W (T4W)
				
Renault				
Avantime (DE0) Avantime (DE0)	09/01->05/03	6NM 007 878-501	1	Headlight levelling actuator (for halogen headlight)
				









Renault



Manufacturer Model	Model year	Part no.	Pk.	Note
Renault				
Clio II (B/C/B0/1_) Clio II (B/C/B0/1_) RN, RT, RXE, SI	09/98->05/01	1LE 007 350-111	1	H4 headlight, left, with indicator light, without headlight levelling actuator, without bulbs
		1LE 007 350-121	1	H4 headlight, right, with indicator light, without headlight levelling actuator, without bulbs
		6NM 007 878-501	1	Accessories: Headlight levelling actuator
		8GJ 002 525-131 8GP 003 594-121 8GA 006 841-121	1 1 1	Spare Parts: 1x12V60/55W (H4) 1x12V5W (W5W) 1x12V21W (PY21W)
Clio II (B/C/B0/1_) Initiale, 16V	09/98->05/01	1LL 007 510-071	1	DE@-HB3/H7 headlight, left, with indicator light, without headlight levelling actuator, without bulbs
		1LL 007 510-081	1	DE@-HB3/H7 headlight, right, with indicator light, without headlight levelling actuator, without bulbs
		6NM 007 878-501 8KA 152 601-001	1 1	Accessories: Headlight levelling actuator Lead for converting from H4 headlight to DE@-HB3/H7 headlight (to be ordered separately)
		8GH 005 635-121 8GH 007 157-121 8GP 003 594-121 8GA 006 841-121	1 1 1 1	Spare Parts: 1x12V60W (HB3) 1x12V55W (H7) 1x12V5W (W5W) 1x12V21W (PY21W)
Clio II (B/C/B0/1_)	06/01->12/03	1LB 008 461-551	1	H1/H7 headlight, left, with indicator light, without headlight levelling actuator, with bulbs
		1LB 008 461-561	1	H1/H7 headlight, right, with indicator light, without headlight levelling actuator, with bulbs
		6NM 007 878-501	1	Accessories: Headlight levelling actuator
		8GH 007 157-121 8GH 002 089-133 8GP 003 594-121 8GA 006 841-121	1 1 1 1	Spare Parts: 1x12V55W (H7) 1x12V55W (H1) 1x12V5W (W5W) 1x12V21W (PY21W)
Clio II (B/C/B0/1_)	01/04->05/09	1LB 008 461-751	1	H1/H7 headlight, left, with indicator light, without headlight levelling actuator, with bulbs
		1LB 008 461-761	1	H1/H7 headlight, right, with indicator light, without headlight levelling actuator, with bulbs
		6NM 007 878-501	1	Accessories: Headlight levelling actuator
		8GH 007 157-121 8GH 002 089-133 8GP 003 594-121 8GA 006 841-121	1 1 1 1	Spare Parts: 1x12V55W (H7) 1x12V55W (H1) 1x12V5W (W5W) 1x12V21W (PY21W)
Clio II (B/C/B0/1_)	09/98->05/09	6NM 007 878-501	1	Headlight levelling actuator



Manufacturer Model	Model year	Part no.	Pk.	Note
Renault				
Espace III (JE_) Espace III (JE_)	11/96->09/00	 1LG 006 560-211 1LG 006 560-221 6NM 007 878-501 8GH 002 089-133 8GP 003 594-121	1 1 1 1 1	FF®-H1 headlight, left, without headlight levelling actuator, for vehicles with electric headlight leveller FF®-H1 headlight, right, without headlight levelling actuator, for vehicles with electric headlight leveller Accessories: Headlight levelling actuator Spare Parts: 2x12V55W (H1) UV-cut 1x12V5W (W5W)
Espace III (JE_)	11/96->10/02	 6NM 007 878-501	1	Headlight levelling actuator (for halogen headlight)
Grand Scénic II Grand Scénic II	08/06->	 1LL 009 447-111 1LL 009 447-121 8GH 007 157-121 8GH 002 089-133 8GA 006 841-121 8GP 003 594-121	1 1 1 1 1 1	H1/H7 headlight, left, with indicator light, without electric headlight levelling actuator, without bulbs H1/H7 headlight, right, with indicator light, without electric headlight levelling actuator, without bulbs Spare Parts: 1x12V55W (H7) 1x12V55W (H1) 1x12V21W (PY21W) 1x12V5W (W5W)
Grand Scénic II	04/04->07/06	 6NM 007 878-501	1	Headlight levelling actuator (for halogen headlight)
Grand Scénic II	08/06->	 5DV 009 000-001	1	Ballast unit
Grand Scénic II	04/04->01/05	 2SK 008 659-091 2SK 008 659-101 8GD 002 078-121 8GA 002 073-121 8GA 006 841-121	1 1 1 1 1	Combination rearlight (red/pink/red), left, with rear fog and reverse light, with bulbs Combination rearlight (red/pink/red), right, with rear fog and reverse light, with bulbs Spare Parts: 1x12V21/5W (P21/5W) 2x12V21W (P21W) 1x12V21W (PY21W)









Renault



Manufacturer Model	Model year	Part no.	Pk.	Note
Renault				
Grand Scénic II Grand Scénic II	01/05->07/06	 2SK 008 659-111 2SK 008 659-121 8GD 002 078-121 8GA 002 073-121 8GA 006 841-121	1 1 1 1 1	Combination rearlight (red/clear/red), left, with rear fog and reverse light, with bulbs Combination rearlight (red/clear/red), right, with rear fog and reverse light, with bulbs Spare Parts: 1x12V21/5W (P21/5W) 2x12V21W (P21W) 1x12V21W (PY21W)
Grand Scénic II	08/06->	 2SK 009 467-111 2SK 009 467-121 8GA 002 073-121 8GA 006 841-121	1 1 1 1	Combination rearlight, left, with rear fog and reverse light, with LED tail light, with bulbs Combination rearlight, right, with rear fog and reverse light, with LED tail light, with bulbs Spare Parts: 2x12V21W (P21W) 1x12V21W (PY21W)
Kangoo (KC0/1_) Kangoo (KC0/1_)	03/98->01/08		1	Headlight levelling actuator
Laguna (B56_, 556_, K56_) Laguna (B56_, 556_, K56_)	11/93->05/98	 1LG 006 560-211 1LG 006 560-221 8GH 002 089-133 8GP 003 594-121	1 1 1 1	FF®-H1 headlight, left, without headlight levelling actuator, for vehicles with electric headlight leveller FF®-H1 headlight, right, without headlight levelling actuator, for vehicles with electric headlight leveller Spare Parts: 2x12V55W (H1) UV-cut 1x12V5W (W5W)
Laguna (B56_, 556_, K56_)	05/98->03/01	 1LJ 007 833-111 1LJ 007 833-121 6NM 007 878-501 8GH 007 157-121 8GA 006 841-121 8GP 003 594-121	1 1 1 1 1 1	H7 headlight, left, with body/lens for indicator light H7 headlight, right, with body/lens for indicator light Accessories: Headlight levelling actuator Spare Parts: 2x12V55W (H7) 1x12V21W (PY21W) 1x12V5W (W5W)







Manufacturer Model	Model year	Part no.	Pk.	Note
Renault				
Laguna (B56_, 556_, K56_) Laguna (B56_, 556_, K56_)	05/98->03/01	6NM 007 878-501	1	Headlight levelling actuator
				
Laguna (B56_, 556_, K56_)	04/94->05/98	9BG 142 247-021 9BG 142 248-021	1 1	Body/lens for indicator light, left Body/lens for indicator light, right
				
		8GA 002 073-121	1	Accessories: 1x12V21W (P21W)
Laguna II (BG0/1_, KG0/1_) Laguna II (BG0/1_, KG0/1_)	03/01->	6NM 007 878-501	1	Headlight levelling actuator (for halogen headlight)
				
Mastermaxi (FH/HH/UH) Mastermaxi (FH/HH/UH)	04/98->	6NM 007 878-501	1	Headlight levelling actuator
				
Mégane I Mégane Hatchback (BA0/1_) Mégane Convertible (EA0/1_) Mégane Coach (DA0/1_) Mégane Classic (LA0/1_) Mégane Scenic (JA0/1_)	01/96->08/03 10/96->08/03 03/96->08/03 09/96->08/03 01/97->09/99	6NM 007 878-501	1	Headlight levelling actuator
				
Mégane Hatchback (BA0/1_)	03/99->08/03	2VP 008 101-031 2VP 008 101-041	1 1	Combination rearlight, left, with rear fog and reverse light Combination rearlight, right, with rear fog and reverse light
				
		8GA 002 071-121	1	Accessories: 1x12V5W (R5W)
		8GD 002 078-121	1	1x12V21/5W (P21/5W)
		8GA 002 073-121	1	2x12V21W (P21W)
		8GA 006 841-121	1	1x12V21W (PY21W)







Renault



Manufacturer Model	Model year	Part no.	Pk.	Note
Renault				
Mégane II Mégane II CC (EM0/1_)	09/03->	2VP 008 736-111	1	Combination rearlight, left, with rear fog and reverse light, with bulbs
		2VP 008 736-121	1	Combination rearlight, right, with rear fog and reverse light, with bulbs
		8GD 002 078-121	1	1x12V21/5W (P21/5W)
		8GA 002 073-121	1	2x12V21W (P21W)
		8GA 006 841-121	1	1x12V21W (PY21W)
Mégane II Sport Tourer (KM0/1_)	01/06->	2VP 982 006-011	1	Combination rearlight, left, with rear fog and reverse light, with bulbs
		2VP 982 006-021	1	Combination rearlight, right, with rear fog and reverse light, with bulbs
		8GD 002 078-121	1	1x12V21/5W (P21/5W)
		8GA 002 073-121	1	2x12V21W (P21W)
		8GA 006 841-121	1	1x12V21W (PY21W)
Safrane I (B54_)	04/92->07/96	6NM 007 878-501	1	Headlight levelling actuator (for halogen headlight)
Safrane I (B54_)				
				
Safrane II (B54_)	07/96->12/00	6NM 007 878-501	1	Headlight levelling actuator (for halogen headlight)
Safrane II (B54_)				
				
Scénic I (JA0/1_)	09/99->08/03	6NM 007 878-501	1	Headlight levelling actuator
Scénic I (JA0/1_)				
				



Manufacturer Model	Model year	Part no.	Pk.	Note
Renault				
Scénic II (JM0/1_) Scénic II (JM0/1_)	08/06->	 1LL 009 447-111 1LL 009 447-121 8GH 007 157-121 8GH 002 089-133 8GA 006 841-121 8GP 003 594-121	1 1 1 1 1 1	H1/H7 headlight, left, with indicator light, without electric headlight levelling actuator, without bulbs H1/H7 headlight, right, with indicator light, without electric headlight levelling actuator, without bulbs Spare Parts: 1x12V55W (H7) 1x12V55W (H1) 1x12V21W (PY21W) 1x12V5W (W5W)
Scénic II (JM0/1_)	06/03->07/06	 6NM 007 878-501	1	Headlight levelling actuator (for halogen headlight)
Scénic II (JM0/1_)	08/06->	 5DV 009 000-001	1	Ballast unit
Scénic II (JM0/1_)	06/03->01/05	 2SK 008 659-091 2SK 008 659-101 8GD 002 078-121 8GA 002 073-121 8GA 006 841-121	1 1 1 1 1	Combination rearlight (red/pink/red), left, with rear fog and reverse light, with bulbs Combination rearlight (red/pink/red), right, with rear fog and reverse light, with bulbs Spare Parts: 1x12V21/5W (P21/5W) 2x12V21W (P21W) 1x12V21W (PY21W)
Scénic II (JM0/1_)	01/05->07/06	 2SK 008 659-111 2SK 008 659-121 8GD 002 078-121 8GA 002 073-121 8GA 006 841-121	1 1 1 1 1	Combination rearlight (red/clear/red), left, with rear fog and reverse light, with bulbs Combination rearlight (red/clear/red), right, with rear fog and reverse light, with bulbs Spare Parts: 1x12V21/5W (P21/5W) 2x12V21W (P21W) 1x12V21W (PY21W)



Renault



Manufacturer Model	Model year	Part no.	Pk.	Note
Renault				
Scénic II (JM0/1_) Scénic II (JM0/1_)	08/06->	 2SK 009 467-111 2SK 009 467-121 8GA 002 073-121 8GA 006 841-121	1 1 1 1	Combination rearlight, left, with rear fog and reverse light, with LED tail light, with bulbs Combination rearlight, right, with rear fog and reverse light, with LED tail light, with bulbs Spare Parts: 2x12V21W (P21W) 1x12V21W (PY21W)
Twingo (C06_/S06_) Twingo (C06_/S06_)	03/93->		1	Headlight levelling actuator
Twingo (C06_/S06_)	03/93->08/98	 1NL 007 186-027 9HD 149 253-007 8JD 156 150-807 8GH 002 090-133	30 160 1 1	DE®-H3 fog light with bulb Spare Parts: Plastic cap Counterplug set (to be ordered separately) 1x12V55W (H3)
Twingo (CN0_) Twingo (CN0_)	03/07->	 1L7 271 510-331 1L7 271 510-341 8GJ 002 525-131 8GP 003 594-121 8GA 006 841-121	1 1 1 1 1	FF®-H4 headlight, left, with indicator light, with chrome-plated cover, without electric headlight levelling actuator FF®-H4 headlight, right, with indicator light, with chrome-plated cover, without electric headlight levelling actuator Spare Parts: 1x12V60/55W (H4) 1x12V5W (W5W) 1x12V21W (PY21W)
Twingo (CN0_) Twingo (CN0_)	03/07->	 1L7 271 510-371 1L7 271 510-381 8GJ 002 525-131 8GP 003 594-121 8GA 006 841-121	1 1 1 1 1	FF®-H4 headlight, left, with indicator light, with black cover, without electric headlight levelling actuator FF®-H4 headlight, right, with indicator light, with black cover, without electric headlight levelling actuator Spare Parts: 1x12V60/55W (H4) 1x12V5W (W5W) 1x12V21W (PY21W)
Vel Satis (BJ0) Vel Satis (BJ0)	06/02->		1	Headlight levelling actuator (for halogen headlight)



Manufacturer Model	Model year	Part no.	Pk.	Note
Renault				
19 II		6NM 007 878-501	1	Headlight levelling actuator
19 II Hatchback (B/C53_)	04/92->12/95			
19 II Chamade (L53_)	04/92->12/95			
19 II Convertible (D53_, 853_)	04/92->06/96			
				
19 II Hatchback (B/C53_)	04/92->12/95	9EL 144 131-001	1	Body/lens for combination rearlight, left, with reverse light
19 II Convertible (D53_, 853_)	04/92->06/96	9EL 144 132-001	1	Body/lens for combination rearlight, right, with reverse light
				
		8GD 002 078-121	1	Accessories: 1x12V21/5W (P21/5W)
		8GA 002 073-121	1	2x12V21W (P21W)
Saab				
900 I				H4 headlight for vehicles with or without headlight leveller, only spare parts available
900 I	08/86->06/94			
				
		9ES 133 383-005	5	Spare Parts: Lens, left
		9ES 133 384-005	5	Lens, right
		8GJ 002 525-131	1	1x12V60/55W (H4)
Seat				
Alhambra (7V8, 7V9)		9EL 147 073-001	2	Body/lens for auxiliary indicator light (amber)
Alhambra (7V8, 7V9)	04/96->06/00			
				
		8GP 003 594-121	1	Accessories: 1x12V5W (W5W)
Alhambra (7V8, 7V9)	04/96->06/00	9EL 147 073-801	1	Body/lens set for auxiliary indicator light (grey)
				
		8GP 003 594-121	1	Accessories: 2x12V5W (W5W)
Alhambra (7V8, 7V9)	06/00->03/10	9EL 156 099-801	1	Body/lens set for auxiliary indicator light (clear), with 2 amber bulbs
				
		8GP 003 594-541	1	Spare Parts: 2x12V5W (WY5W)

**Seat**

Manufacturer Model	Model year	Part no.	Pk.	Note
Seat				
Alhambra (7V8, 7V9) Alhambra (7V8, 7V9)	04/96->06/00	9EL 907 325-001 9EL 907 326-001 8GA 002 071-121 8GD 002 078-121 8GA 002 073-121	1 1 1 1 1	Body/lens for combination rearlight, left, outer part (red) Body/lens for combination rearlight, right, outer part (red) Accessories: 1x12V5W (R5W) 1x12V21/5W (P21/5W) 1x12V21W (P21W)
Alhambra (7V8, 7V9)	06/00->03/10	9EL 964 501-011 9EL 964 502-011 8GA 002 071-121 8GA 002 073-121	1 1 1 1	Body/lens for combination rearlight, left, outer part (red/pink) Body/lens for combination rearlight, right, outer part (red/pink) Accessories: 1x12V5W (R5W) 2x12V21W (P21W)
Altea (5P1) Altea (5P1)	03/04->03/09	1N0 271 022-051 1N0 271 022-061 8GH 002 090-133	1 1 1	H3 fog light, left, with bulb H3 fog light, right, with bulb Spare Parts: 1x12V55W (H3)
up to chassis no. 5P-9-053 200*				
Altea XL (5P5) Altea XL (5P5)	10/06->03/09	1N0 271 022-051 1N0 271 022-061 8GH 002 090-133	1 1 1	H3 fog light, left, with bulb H3 fog light, right, with bulb Spare Parts: 1x12V55W (H3)
up to chassis no. 5P-9-053 200*				
Altea XL (5P5) (-) Sport	10/06->	9EL 354 080-011 9EL 354 080-021 8GA 002 073-121 8GA 006 841-121	1 1 1 1	Body/lens for combination rearlight, left, outer part Body/lens for combination rearlight, right, outer part Accessories: 1x12V21W (P21W) 1x12V21W (PY21W)



Manufacturer Model	Model year	Part no.	Pk.	Note
Seat				
Altea XL (5P5)		9EL 354 081-011	1	Body/lens for combination rearlight, left, inner part, with reverse light
Altea XL (5P5) (-) Sport	10/06->	9EL 354 082-021	1	Body/lens for combination rearlight, right, inner part, with rear fog light
		8GA 002 073-121	1	Spare Parts: 1x12V21W (P21W)
		8GP 003 594-121	1	1x12V5W (W5W)
Arosa (6H)		6NM 007 878-041	1	Headlight levelling actuator (for halogen headlight)
Arosa (6H)	05/97->06/04			
				
Arosa (6H)	05/97->06/04	1N0 270 204-051	1	FF®-H3 fog light, left, with bulb
		1N0 270 204-061	1	FF®-H3 fog light, right, with bulb
		8GH 002 090-133	1	Spare Parts: 1x12V55W (H3)
Arosa (6H)	05/97->06/04	9EL 156 099-801	1	Body/lens set for auxiliary indicator light (clear), with 2 amber bulbs
		8GP 003 594-541	1	Spare Parts: 2x12V5W (WY5W)
				
Cordoba I		1NA 961 557-751	1	H3 fog light, left
Cordoba I 4-doors	02/93->03/97	1NA 961 557-761	1	H3 fog light, right
		8GH 002 090-133	1	Accessories: 2x12V55W (H3)
Cordoba I 2/4-doors, Cordoba Vario	04/97->06/99	1NA 907 312-111	1	H3 fog light, left
(-) Cupra		1NA 907 312-121	1	H3 fog light, right
		8GH 002 090-133	1	Accessories: 1x12V55W (H3)
Cordoba I	02/93->06/99	9EL 147 073-001	2	Body/lens for auxiliary indicator light (amber)
		8GP 003 594-121	1	Accessories: 1x12V5W (W5W)



Seat









Manufacturer Model	Model year	Part no.	Pk.	Note
Seat				
Cordoba I Cordoba I	02/93->06/99	9EL 147 073-801 8GP 003 594-121	1 1	Body/lens set for auxiliary indicator light (grey) Accessories: 2x12V5W (W5W)
				
Cordoba II Hatchback Cordoba II Hatchback (6K2)	06/99->10/02	6NM 007 878-041	1	Headlight levelling actuator
from chassis no. 6K-X-400 000				
Cordoba II Hatchback (6K2) (-) Cupra	06/99->10/02	1NA 963 965-051 1NA 963 965-061 8GH 007 157-121	1 1 1	FF®-H7 fog light, left, with bulb FF®-H7 fog light, right, with bulb Spare Parts: 1x12V55W (H7)
				
Cordoba II Vario (6K5) Cordoba II Vario (6K5)	06/99->12/02	6NM 007 878-041	1	Headlight levelling actuator
from chassis no. 6K-X-400 000				
Cordoba III (6L2) Cordoba III (6L2)	09/02->	6NM 007 878-041	1	Headlight levelling actuator (for halogen headlight)
				
Cordoba III (6L2)	09/02->	1N0 009 617-011 8GH 002 090-133	1 1	FF®-H3 fog light, left and right, with bulb Spare Parts: 1x12V55W (H3)
				



Manufacturer Model	Model year	Part no.	Pk.	Note
Seat				
Cordoba III (6L2) Cordoba III (6L2)	09/02->	9EL 964 949-001 9EL 964 950-001 8GD 002 078-121 8GA 008 246-001	1 1 1 1	Body/lens for combination rearlight, left, outer part Body/lens for combination rearlight, right, outer part Accessories: 1x12V21/5W (P21/5W) 1x12V16W (W16W)
				
Ibiza I (021A) Ibiza I (021A)	03/91->12/93	1NA 961 557-731 1NA 961 557-741 8GH 002 090-133	1 1 1	H3 fog light, left H3 fog light, right Accessories: 1x12V55W (H3)
				
Ibiza II (6K1) Ibiza II (6K1) 5-doors	03/93->03/97	1NA 961 557-751 1NA 961 557-761 8GH 002 090-133	1 1 1	H3 fog light, left H3 fog light, right Accessories: 2x12V55W (H3)
				
Ibiza II (6K1) 3/5-doors (-) Cupra	04/97->08/99	1NA 907 312-111 1NA 907 312-121 8GH 002 090-133	1 1 1	H3 fog light, left H3 fog light, right Accessories: 1x12V55W (H3)
				
Ibiza II (6K1)	03/93->08/99	9EL 147 073-001 8GP 003 594-121	2 1	Body/lens for auxiliary indicator light (amber) Accessories: 1x12V5W (W5W)
				
Ibiza II (6K1)	03/93->08/99	9EL 147 073-801 8GP 003 594-121	1 1	Body/lens set for auxiliary indicator light (grey) Accessories: 2x12V5W (W5W)
 				
Ibiza III (6K1) Ibiza III (6K1) from chassis no. 6K-X-400 000	08/99->02/02	6NM 007 878-041	1	Headlight levelling actuator
				
Ibiza III (6K1) (-) Cupra	08/99->02/02	1NA 963 965-051 1NA 963 965-061 8GH 007 157-121	1 1 1	FF®-H7 fog light, left, with bulb FF®-H7 fog light, right, with bulb Spare Parts: 1x12V55W (H7)
				

**Seat**

Manufacturer Model	Model year	Part no.	Pk.	Note
Seat				
Ibiza III (6K1) Ibiza III (6K1)	08/99->02/02	9EL 964 023-011 9EL 964 024-011 8GD 002 078-121 8GA 002 073-121	1 1 1 1	Body/lens for combination rearlight, left, outer part, with reverse light Body/lens for combination rearlight, right, outer part, with reverse light Accessories: 1x12V21/5W (P21/5W) 2x12V21W (P21W)
				
Ibiza III (6K1)	08/99->02/02	9EL 964 055-011 9EL 964 056-011 8GA 002 073-121	1 1 1	Body/lens for combination rearlight, left, inner part, with rear fog light Body/lens for combination rearlight, right, inner part, with rear fog light Accessories: 1x12V21W (P21W)
				
Ibiza IV (6L1) Ibiza IV (6L1)	02/02->	6NM 007 878-041	1	Headlight levelling actuator (for halogen headlight)
				
Ibiza IV (6L1) Ibiza IV (6L1) for PR no. 2JG, 2JQ (Sport bumper, bumper in vehicle colour)	02/02->04/06 05/06->05/08	1N0 009 617-011 8GH 002 090-133	1 1	FF®-H3 fog light, left and right, with bulb Spare Parts: 1x12V55W (H3)
				
Ibiza IV (6L1) for PR no. 2JD, 2JV (Sport bumper, bumper in vehicle colour)	05/06->05/08	1N0 271 022-051 1N0 271 022-061 8GH 002 090-133	1 1 1	H3 fog light, left, with bulb H3 fog light, right, with bulb Spare Parts: 1x12V55W (H3)
				
Ibiza IV (6L1)	02/02->	8RA 354 036-011 8RA 354 036-021	1 1	Reflex-reflector (red), left Reflex-reflector (red), right
				



Manufacturer Model	Model year	Part no.	Pk.	Note
Seat				
Leon (1M1) Leon (1M1)	11/99->06/06	 6NM 007 878-041	1	Headlight levelling actuator
Leon (1M1) 1.8 T Cupra R, Limited Edition for PR no. E5K, E7S	02/02->06/06	 1NL 007 906-031 1NL 007 906-041 8GH 002 090-133	1 1 1	DE@-H3 fog light, left DE@-H3 fog light, right Accessories: 1x12V55W (H3)
Leon (1M1)	11/99->06/06	 9EL 156 099-801 8GP 003 594-541	1 1	Body/lens set for auxiliary indicator light (clear), with 2 amber bulbs Spare Parts: 2x12V5W (WY5W)
Leon (1P1) Leon (1P1) up to chassis no. 1P-9-060 000*	05/05->	 1N0 271 022-051 1N0 271 022-061 8GH 002 090-133	1 1 1	H3 fog light, left, with bulb H3 fog light, right, with bulb Spare Parts: 1x12V55W (H3)
Leon (1P1) up to chassis no. 1P-9-057 500	05/05->	 9EL 982 000-051 9EL 982 000-061 8GD 002 078-121	1 1 1	Body/lens for combination rearlight, left, outer part Body/lens for combination rearlight, right, outer part Accessories: 2x12V21/5W (P21/5W)









Seat



Manufacturer Model	Model year	Part no.	Pk.	Note
Seat				
Leon (1P1) Leon (1P1) up to chassis no. 1P-9-057 500	05/05->	 9EL 982 001-111 9EL 982 001-121 8GA 002 073-121 8GP 003 594-121	1 1 1 1	Body/lens for tail light and reverse light, left Body/lens for tail light and rear fog light, right Spare Parts: 1x12V21W (P21W) 1x12V5W (W5W)
Toledo I (1L) Toledo I (1L)	05/91->08/95	 1NA 961 557-731 1NA 961 557-741 8GH 002 090-133	1 1 1	H3 fog light, left H3 fog light, right Accessories: 1x12V55W (H3)
Toledo I (1L)	09/95->03/99	 1NA 963 022-031 1NA 963 022-041 8GH 002 090-133	1 1 1	H3 fog light, left H3 fog light, right Accessories: 1x12V55W (H3)
Toledo I (1L) CL, GL	05/91->08/95	 9EL 144 443-001 9EL 144 444-001 8GA 002 073-121	1 1 1	Body/lens for indicator light (amber), left Body/lens for indicator light (amber), right Accessories: 1x12V21W (P21W)
Toledo I (1L) CL, GL	05/91->08/95	 2BA 961 554-111 2BA 961 554-121 8GA 006 841-121	1 1 1	Indicator light (white), left, with bulb, for conversion Indicator light (white), right, with bulb, for conversion Spare Parts: 1x12V21W (PY21W)
Toledo I (1L) GLX, GT, GT 16V	05/91->08/95	 2BA 961 554-111 2BA 961 554-121 8GA 006 841-121	1 1 1	Indicator light (white), left, with bulb Indicator light (white), right, with bulb Spare Parts: 1x12V21W (PY21W)



Manufacturer Model	Model year	Part no.	Pk.	Note
Seat				
Toledo I (1L) Toledo I (1L)	09/95->03/99	 9EL 963 261-011 9EL 963 262-011 8GA 006 841-121	1 1 1	Body/lens for indicator light (white), left Body/lens for indicator light (white), right Accessories: 1x12V21W (PY21W)
Toledo I (1L)	09/95->03/99	 9EL 147 073-001 8GP 003 594-121	2 1	Body/lens for auxiliary indicator light (amber) Accessories: 1x12V5W (W5W)
Toledo I (1L)	09/95->03/99	 9EL 147 073-801 8GP 003 594-121 Design	1 1	Body/lens set for auxiliary indicator light (grey) Accessories: 2x12V5W (W5W)
Toledo I (1L) CL, GL	05/91->08/95	 9EL 962 025-011 8GD 002 078-121 8GA 002 073-121	1 1 1	Body/lens for combination rearlight, left, outer part (amber/red) Accessories: 1x12V21/5W (P21/5W) 1x12V21W (P21W)
Toledo I (1L) CL, GL	05/91->08/95	 9EL 962 027-011 9EL 962 028-011 8GD 002 078-121 8GA 002 073-121 Design	1 1 1 1	Body/lens for combination rearlight, left, outer part (red), for conversion Body/lens for combination rearlight, right, outer part (red), for conversion Accessories: 1x12V21/5W (P21/5W) 1x12V21W (P21W)
Toledo I (1L) GLX, GT, GT 16V	09/91->08/95	 9EL 962 027-011 9EL 962 028-011 8GD 002 078-121 8GA 002 073-121	1 1 1 1	Body/lens for combination rearlight, left, outer part (red) Body/lens for combination rearlight, right, outer part (red) Accessories: 1x12V21/5W (P21/5W) 1x12V21W (P21W)







Seat



Manufacturer Model	Model year	Part no.	Pk.	Note
Seat				
Toledo I (1L)		9EL 962 025-031	1	Body/lens for combination rearlight, left, outer part (grey/red)
Toledo I (1L)	09/95->03/99	9EL 962 026-031	1	Body/lens for combination rearlight, right, outer part (grey/red)
		8GD 002 078-121	1	Accessories: 1x12V21/5W (P21/5W)
		8GA 002 073-121	1	1x12V21W (P21W)
Toledo II (1M2)		6NM 007 878-041	1	Headlight levelling actuator
Toledo II (1M2)	04/99->05/06			
Toledo II (1M2) Cupra R	02/02->05/06	1NL 007 906-031	1	DE@-H3 fog light, left
		1NL 007 906-041	1	DE@-H3 fog light, right
		8GH 002 090-133	1	Accessories: 1x12V55W (H3)
Toledo II (1M2)	04/99->05/06	9EL 156 099-801	1	Body/lens set for auxiliary indicator light (clear), with 2 amber bulbs
		8GP 003 594-541	1	Accessories: 2x12V5W (WY5W)
				
Toledo II (1M2)	04/99->05/06	9EL 963 701-011	1	Body/lens for combination rearlight, left, outer part (red/white)
(-) Sport		9EL 963 702-011	1	Body/lens for combination rearlight, right, outer part (red/white)
		8GD 002 078-121	1	Accessories: 1x12V21/5W (P21/5W)
		8GA 006 841-121	1	1x12V21W (PY21W)
Toledo II (1M2)	04/99->05/06	9EL 964 599-001	1	Body/lens with rear panel, inner part (red/white), with reverse light left and right, rear fog light left and right, licence plate light and auxiliary brake light
(-) Sport				
		8GA 002 071-121	1	Accessories: 2x12V5W (R5W)
		8GA 002 073-121	1	4x12V21W (P21W)



Manufacturer Model	Model year	Part no.	Pk.	Note
Seat				
Toledo III (5P2)		1N0 271 022-051	1	H3 fog light, left, with bulb
Toledo III (5P2)	10/04->	1N0 271 022-061	1	H3 fog light, right, with bulb
		8GH 002 090-133	1	Spare Parts: 1x12V55W (H3)
Skoda				
Fabia (6Y)		6NM 007 878-521	1	Headlight levelling actuator
Fabia (6Y)	12/99->03/08			
Fabia (6Y)	08/04->	1N0 270 481-051	1	FF®-HB4 fog light, left, with bulb
Chassis no. -> 6Y-54421 759		1N0 270 481-061	1	FF®-HB4 fog light, right, with bulb
		8GH 005 636-121	1	Spare Parts: 1x12V51W (HB4)
Fabia (6Y)		1N0 271 247-051	1	FF®-HB4 fog light, left, with bulb
(-) RS		1N0 271 247-061	1	FF®-HB4 fog light, right, with bulb
Chassis no. 6Y-54421 760 -> 6Y-7B452 577		8GH 005 636-121	1	Spare Parts: 1x12V51W (HB4)
				
Fabia RS (6Y)	06/03->03/08	1N0 270 204-051	1	FF®-H3 fog light, left, with bulb
		1N0 270 204-061	1	FF®-H3 fog light, right, with bulb
		8GH 002 090-133	1	Spare Parts: 1x12V55W (H3)



Skoda



Manufacturer Model	Model year	Part no.	Pk.	Note
Skoda				
Fabia (6Y)		9EL 171 976-011	1	Body/lens for combination rearlight, left, with rear fog and reverse light
Fabia Hatchback (6Y2)	08/99->08/04	9EL 171 976-021	1	Body/lens for combination rearlight, right, with rear fog and reverse light
		8GD 004 772-121	1	Accessories: 1x12V21/4W (P21/4W)
		8GA 002 073-121	1	2x12V21W (P21W)
		8GA 006 841-121	1	1x12V21W (PY21W)
Fabia Sedan (6Y3)	10/99->08/04	9EL 171 977-011	1	Body/lens for combination rearlight, left, with rear fog and reverse light
Fabia Estate (6Y5)	04/00->08/04	9EL 171 977-021	1	Body/lens for combination rearlight, right, with rear fog and reverse light
		8GD 004 772-121	1	Accessories: 1x12V21/4W (P21/4W)
		8GA 002 073-121	1	2x12V21W (P21W)
		8GA 006 841-121	1	1x12V21W (PY21W)
Fabia Hatchback (6Y2)	08/04->03/08	9EL 171 974-011	1	Body/lens for combination rearlight, left, with rear fog and reverse light
		9EL 171 974-021	1	Body/lens for combination rearlight, right, with rear fog and reverse light
		8GD 004 772-121	1	Accessories: 1x12V21/4W (P21/4W)
		8GA 002 073-121	1	2x12V21W (P21W)
		8GA 006 841-121	1	1x12V21W (PY21W)
Fabia Sedan (6Y3)	08/04->03/08	9EL 171 975-011	1	Body/lens for combination rearlight, left, with rear fog and reverse light
Fabia Estate (6Y5)	08/04->12/07	9EL 171 975-021	1	Body/lens for combination rearlight, right, with rear fog and reverse light
		8GD 004 772-121	1	Accessories: 1x12V21/4W (P21/4W)
		8GA 002 073-121	1	2x12V21W (P21W)
		8GA 006 841-121	1	1x12V21W (PY21W)



Manufacturer Model	Model year	Part no.	Pk.	Note
Skoda				
Fabia II Fabia II for PR no. 8BF, 8Q1 from chassis no. 5J-BB500000, 5J-BK500000, 5J-B3008700	03/10->	1LD 010 417-351 1LD 010 417-361 8GJ 002 525-131 8GP 003 594-121 8GA 006 841-121	1 1 1 1 1	FF®-H4 headlight, left, with indicator light, with electric headlight levelling actuator FF®-H4 headlight, right, with indicator light, with electric headlight levelling actuator Accessories: 1x12V60/55W (H4) 1x12V5W (W5W) 1x12V21W (PY21W)
Fabia II for PR no. 8JK, Q1 from chassis no. 5J-BB500000, 5J-BK500000, 5J-B3008700 (-) bend lighting	03/10->	1LL 010 417-391 1LL 010 417-401 8GH 007 157-121 8GP 003 594-121	1 1 1 1	FF®-H7 headlight, left, with indicator light, without bend lighting, with electric headlight levelling actuator FF®-H7 headlight, right, with indicator light, without bend lighting, with electric headlight levelling actuator Accessories: 2x12V55W (H7) 1x12V5W (W5W) 1x12V21W (PY21W) Long Life
Fabia II for PR no. 8JK, 8Q7 from chassis no. 5J-BB500000, 5J-BK500000, 5J-B3008700 (+) bend lighting	03/10->	1ZL 010 417-431 1ZL 010 417-441 8GH 007 157-121 8GP 003 594-121	1 1 1 1	FF®-H7 headlight, left, with indicator light, with bend lighting, with electric headlight levelling actuator FF®-H7 headlight, right, with indicator light, with bend lighting, with electric headlight levelling actuator Accessories: 2x12V55W (H7) 1x12V5W (W5W) 1x12V21W (PY21W) Long Life
Fabia II up to chassis no. 5J-A...	12/06->03/10	1N0 271 247-051 1N0 271 247-061 8GH 005 636-121	1 1 1	FF®-HB4 fog light, left, with bulb FF®-HB4 fog light, right, with bulb Spare Parts: 1x12V51W (HB4)





Skoda



Manufacturer Model	Model year	Part no.	Pk.	Note
Skoda				
Fabia II		1N0 354 018-011	1	FF®-H8 fog light, left, with cornering light
Fabia II	12/06->03/10	1N0 354 018-021	1	FF®-H8 fog light, right, with cornering light
up to chassis no. 5J-A...		8GH 008 356-121	1	Accessories: 1x12V35W (H8)
with cornering light				
Felicia I		9EL 246 151-021	1	Body/lens for indicator light (white), left
Felicia I	10/94->03/98	9EL 246 152-021	1	Body/lens for indicator light (white), right
		8GA 006 841-121	1	Accessories: 1x12V21W (PY21W)
				
Felicia I	10/94->03/98	9EL 246 201-011	1	Body/lens for combination rearlight (grey/red), left, with rear fog and reverse light
(-) Pickup		9EL 246 202-011	1	Body/lens for combination rearlight (grey/red), right, with rear fog and reverse light
		8GA 002 071-121	1	Accessories: 1x12V5W (R5W)
		8GD 002 078-121	1	1x12V21/5W (P21/5W)
		8GA 002 073-121	1	2x12V21W (P21W)
		8GA 006 841-121	1	1x12V21W (PY21W)
Felicia II (6U1/6U5)		1N0 270 204-051	1	FF®-H3 fog light, left, with bulb
Felicia II (6U1/6U5)	01/98->06/01	1N0 270 204-061	1	FF®-H3 fog light, right, with bulb
		8GH 002 090-133	1	Spare Parts: 1x12V55W (H3)
				
Felicia II (6U1/6U5)	01/98->06/01	9EL 246 151-021	1	Body/lens for indicator light (white), left
		9EL 246 152-021	1	Body/lens for indicator light (white), right
		8GA 006 841-121	1	Accessories: 1x12V21W (PY21W)
				
Felicia II (6U1/6U5)	01/98->06/01	9EL 246 201-011	1	Body/lens for combination rearlight (grey/red), left, with rear fog and reverse light
(-) Pickup		9EL 246 202-011	1	Body/lens for combination rearlight (grey/red), right, with rear fog and reverse light
		8GA 002 071-121	1	Accessories: 1x12V5W (R5W)
		8GD 002 078-121	1	1x12V21/5W (P21/5W)
		8GA 002 073-121	1	2x12V21W (P21W)
		8GA 006 841-121	1	1x12V21W (PY21W)





Manufacturer Model	Model year	Part no.	Pk.	Note
Skoda				
Octavia (1U2/1U5) Octavia (1U2/1U5) LX 	08/00->	1LJ 010 202-051 1LJ 010 202-061 8GJ 002 525-131 8GP 003 594-121	1 1 1 1	H4 headlight, left, without fog light, with electric headlight levelling actuator H4 headlight, right, without fog light, with electric headlight levelling actuator Spare Parts: 1x12V60/55W (H4) 1x12V5W (W5W)
Octavia (1U2/1U5) GLX, SLX 	08/00->	1LL 010 202-071 1LL 010 202-081 8GJ 002 525-131 8GH 002 090-133 8GP 003 594-121	1 1 1 1 1	H4 headlight, left, with DE@-H3 fog light, with electric headlight levelling actuator H4 headlight, right, with DE@-H3 fog light, with electric headlight levelling actuator Spare Parts: 1x12V60/55W (H4) 1x12V55W (H3) 1x12V5W (W5W)
Octavia (1U2/1U5) (+) Xenon light 	08/00->	1LL 010 202-111 1LL 010 202-121 8GS 007 949-101 8GH 002 089-133 8GH 002 090-133 8GP 003 594-121	1 1 1 1 1	Xenon/H1 headlight, left, with DE@-H3 fog light, with electric headlight levelling actuator, with xenon ballast, without gas discharge bulb, with bulbs Xenon/H1 headlight, right, with DE@-H3 fog light, with electric headlight levelling actuator, with xenon ballast, without gas discharge bulb, with bulbs Spare Parts: 1x35W (D2S) 1x12V55W (H1) 1x12V55W (H3) 1x12V5W (W5W)
Octavia (1U2/1U5) from chassis no. 1U-Y-375 001 	01/00->08/00	6NM 007 878-531	1	Headlight levelling actuator
Octavia (1U2/1U5) 	09/96->08/00	9EL 246 175-011 9EL 246 176-011 8GA 006 841-121	1 1 1	Body/lens for indicator light (clear), left Body/lens for indicator light (clear), right Accessories: 1x12V21W (PY21W)
Octavia (1U2/1U5) 	08/00->	9EL 354 075-011 9EL 354 075-021 8GA 006 841-121	1 1 1	Body/lens for indicator light (clear), left Body/lens for indicator light (clear), right Accessories: 1x12V21W (PY21W)







Skoda



Manufacturer Model	Model year	Part no.	Pk.	Note
Skoda				
Octavia (1U2/1U5)		9EL 354 074-011	1	Body/lens for combination rearlight, left, with rear fog and reverse light
Octavia (1U2) (-) Estate	08/00->	9EL 354 074-021	1	Body/lens for combination rearlight, right, with rear fog and reverse light
		8GD 004 772-121	1	Accessories: 1x12V21/4W (P21/4W)
		8GA 002 073-121	1	2x12V21W (P21W)
		8GA 006 841-121	1	1x12V21W (PY21W)
Octavia (1Z3/1Z5)		1LL 354 027-051	1	H1/H7 headlight, left, with indicator light, with electric headlight levelling actuator
Octavia (1Z3/1Z5) for PR no. 8BN up to chassis no. 1Z-7A153 285* 1Z-72324 808* 1Z-78022 190* (-) Xenon light	02/04->12/08	1LL 354 027-061	1	H1/H7 headlight, right, with indicator light, with electric headlight levelling actuator
		8GH 007 157-121	1	Spare Parts: 1x12V55W (H7)
		8GH 002 089-133	1	1x12V55W (H1)
		8GA 006 841-121	1	1x12V21W (PY21W)
		8GP 003 594-121	1	1x12V5W (W5W)
Octavia (1Z3/1Z5) (+) Xenon light	02/04->12/08	1LL 354 027-091	1	Xenon/H1 headlight, left, with indicator light, with electric headlight levelling actuator, with xenon ballast, without gas discharge bulb, with bulbs
		1LL 354 027-101	1	Xenon/H1 headlight, right, with indicator light, with electric headlight levelling actuator, with xenon ballast, without gas discharge bulb, with bulbs
		8GS 009 028-021	1	Spare Parts: 1x35W (D1S)
		8GH 002 089-133	1	1x12V55W (H1)
		8GA 006 841-121	1	1x12V21W (PY21W)
		8GP 003 594-121	1	1x12V5W (W5W)
Octavia (1Z3/1Z5) from chassis no. 1Z-9-000 001	01/09->	1LL 247 052-271	1	DE@-H7/FF@-H1 headlight, left, with indicator light, with electric headlight levelling actuator
		1LL 247 052-281	1	DE@-H7/FF@-H1 headlight, right, with indicator light, with electric headlight levelling actuator
		8GH 007 157-121	1	Accessories: 1x12V55W (H7)
		8GH 002 089-133	1	1x12V55W (H1)
		8GA 006 841-121	1	1x12V21W (PY21W)
		8GP 003 594-121	1	1x12V5W (W5W)







Manufacturer Model	Model year	Part no.	Pk.	Note
Skoda				
Octavia (1Z3/1Z5)		1N0 354 017-011	1	FF®-H8 fog light, left
Octavia (1Z3/1Z5)	02/04->12/08	1N0 354 017-021	1	FF®-H8 fog light, right
up to chassis no. 1Z-7A152 170* 1Z-7B153 948* 1Z-72163 388* 1Z-78036 658*		8GH 008 356-121	1	Accessories: 1x12V35W (H8)
				
Octavia (1Z3/1Z5)	02/04->12/08	1N0 354 017-031	1	FF®-H8 fog light, left
from chassis no. 1Z-7A152 180* 1Z-7B153 958* 1Z-82006 001* 1Z-88006 001*		1N0 354 017-041	1	FF®-H8 fog light, right
		8GH 008 356-121	1	Accessories: 1x12V35W (H8)
				
Octavia (1Z3/1Z5)	01/09->	1NH 354 671-011	1	H8 fog light, left, with daytime running light
from chassis no. 1Z-9-000 001		1NH 354 671-021	1	H8 fog light, right, with daytime running light
		8GH 008 356-121	1	Accessories: 1x12V35W (H8)
		8GA 002 073-271	1	1x12V21W (P21W) Long Life
				
Octavia (1Z3)	02/04->12/08	9EL 354 076-011	1	Body/lens for combination rearlight, left, with rear fog and reverse light
(-) Estate, RS		9EL 354 076-021	1	Body/lens for combination rearlight, right, with rear fog and reverse light
		8GD 004 772-151	1	Accessories: 1x12V21/4W (P21/4W) Long Life
		8GA 002 073-121	1	1x12V21W (P21W)
		8GA 006 841-121	1	1x12V21W (PY21W)
		8GP 003 594-141	1	1x12V3W (W3W)
				
Octavia (1Z3)	01/09->	9EL 354 670-011	1	Body/lens for combination rearlight, left, with rear fog and reverse light
from chassis no. 1Z-9-000 001		9EL 354 670-021	1	Body/lens for combination rearlight, right, with rear fog and reverse light
(-) Estate, RS		8GD 004 772-151	1	Spare Parts: 2x12V21/4W (P21/4W) Long Life
		8GA 002 073-121	1	1x12V21W (P21W)
		8GA 006 841-121	1	1x12V21W (PY21W)
		8GP 003 594-141	1	2x12V3W (W3W)
				







Skoda







Manufacturer Model	Model year	Part no.	Pk.	Note
Skoda				
Roomster (5J) Roomster (5J) for PR no. 8BF, 8Q1 from chassis no. 5J-BB600000, 5J-BK600000, 5J-B5006000	03/10->	1LD 010 417-351 1LD 010 417-361 8GJ 002 525-131 8GP 003 594-121 8GA 006 841-121	1 1 1 1 1	FF®-H4 headlight, left, with indicator light, with electric headlight levelling actuator FF®-H4 headlight, right, with indicator light, with electric headlight levelling actuator Accessories: 1x12V60/55W (H4) 1x12V5W (W5W) 1x12V21W (PY21W)
				
Roomster (5J) for PR no. 8JK, Q1 from chassis no. 5J-BB600000, 5J-BK600000, 5J-B5006000 (-) bend lighting	03/10->	1LL 010 417-391 1LL 010 417-401 8GH 007 157-121 8GP 003 594-121	1 1 1 1	FF®-H7 headlight, left, with indicator light, without bend lighting, with electric headlight levelling actuator FF®-H7 headlight, right, with indicator light, without bend lighting, with electric headlight levelling actuator Accessories: 2x12V55W (H7) 1x12V5W (W5W) 1x12V21W (PY21W) Long Life
				
Roomster (5J) for PR no. 8JK, 8Q7 from chassis no. 5J-BB600000, 5J-BK600000, 5J-B5006000 (+) bend lighting	03/10->	1ZL 010 417-431 1ZL 010 417-441 8GH 007 157-121 8GP 003 594-121	1 1 1 1	FF®-H7 headlight, left, with indicator light, with bend lighting, with electric headlight levelling actuator FF®-H7 headlight, right, with indicator light, with bend lighting, with electric headlight levelling actuator Accessories: 2x12V55W (H7) 1x12V5W (W5W) 1x12V21W (PY21W) Long Life
				
Roomster (5J) up to chassis no. 5J-A...	05/06->03/10	1N0 271 247-051 1N0 271 247-061 8GH 005 636-121	1 1 1	FF®-HB4 fog light, left, with bulb FF®-HB4 fog light, right, with bulb Spare Parts: 1x12V51W (HB4)
				



Manufacturer Model	Model year	Part no.	Pk.	Note
Skoda				
Roomster (5J)		1N0 354 018-011	1	FF®-H8 fog light, left, with cornering light
Roomster (5J)	05/06->	1N0 354 018-021	1	FF®-H8 fog light, right, with cornering light
up to chassis no. 5J-A...		8GH 008 356-121	1	Accessories: 1x12V35W (H8)
with corneringlight				
Roomster (5J)	05/06->	9EL 354 077-011	1	Body/lens for combination rearlight, left, with rear fog and reverse light
		9EL 354 077-021	1	Body/lens for combination rearlight, right, with rear fog and reverse light
		8GA 006 841-121	1	Accessories: 1x12V21W (PY21W)
		8GA 002 073-121	1	3x12V21W (P21W)
		8GP 003 594-121	1	2x12V5W (W5W)
				
Superb (3U4)		9EL 354 078-011	1	Body/lens for combination rearlight, left, with rear fog and reverse light
Superb (3U4)	02/02->08/06	9EL 354 078-021	1	Body/lens for combination rearlight, right, with rear fog and reverse light
		8GD 004 772-121	1	Accessories: 1x12V21/4W (P21/4W)
		8GA 002 073-121	1	2x12V21W (P21W)
		8GA 006 841-121	1	1x12V21W (PY21W)
				
Superb (3U4)	09/06->03/08	9EL 354 079-011	1	Body/lens for combination rearlight, left, with rear fog and reverse light
		9EL 354 079-021	1	Body/lens for combination rearlight, right, with rear fog and reverse light
		8GD 004 772-121	1	Accessories: 1x12V21/4W (P21/4W)
		8GA 002 073-121	1	2x12V21W (P21W)
		8GA 006 841-121	1	1x12V21W (PY21W)
				



Manufacturer Model	Model year	Part no.	Pk.	Note
Skoda				
Superb (3T4, 3T5) Superb (3T4, 3T5) for PR no. 8ED, 8Q6 (+) Bi-Xenon light (+) bend lighting	03/08->	1ZS 247 047-351	1	Bi-Xenon®/FF®-H3 headlight, left, with indicator light, with bend lighting, with electric headlight levelling actuator, with xenon ballast, without gas discharge bulb, without bulbs Bi-Xenon®/FF®-H3 headlight, right, with indicator light, with bend lighting, with electric headlight levelling actuator, with xenon ballast, without gas discharge bulb, without bulbs Accessories: Ballast unit 1x35W (D3S) 1x12V55W (H3) 1x12V5W (W5W) Long Life 2x12V16W (W16W)
		1ZS 247 047-361	1	
		5DV 009 000-001	1	
		8GS 009 028-201	1	
		8GH 002 090-133	1	
		8GA 008 246-001	1	
Yeti Yeti	05/09->	9EL 354 672-011	1	Body/lens for combination rearlight, left, with rear fog and reverse light Body/lens for combination rearlight, right, with rear fog and reverse light Accessories: 3x12V21W (P21W) 1x12V21W (PY21W) 1x12V5W (W5W) Long Life
		9EL 354 672-021	1	
		8GA 002 073-121	1	
		8GA 006 841-121	1	
Vauxhall				
Astra Mk I Astra Mk I (UK-built models)	08/79->	2KA 003 485-021	1	Licence plate light with bulb Spare Parts: 1x12V10W (R10W)
		8GA 002 071-131	1	
				
Astra Mk II, Belmont Astra Mk II, Belmont	10/85->08/91	2BM 003 563-111	1	Auxiliary indicator light Spare Parts: 1x12V5W (W5W)
		8GP 003 594-121	1	
				
Astra Mk II, Belmont	10/84->08/91	2KA 003 485-021	1	Licence plate light with bulb Spare Parts: 1x12V10W (R10W)
		8GA 002 071-131	1	
				
Astra II Mk Estate	10/84->08/91	2KA 004 434-031	1	Licence plate light Spare Parts: 1x12V4W (T4W)
		8GP 002 067-121	1	
				



Manufacturer Model	Model year	Part no.	Pk.	Note
Vauxhall				
Astra Mk III (F) Astra Mk III (F) GTE/GSI	09/91->	1NL 006 580-051 1NL 006 580-061 8GH 002 090-133	1 1 1	DE®-H3 fog light, left DE®-H3 fog light, right Spare Parts: 1x12V55W (H3)
				
Astra Mk III (F)	09/91->	2BM 003 563-111 8GP 003 594-121	1 1	Auxiliary indicator light Spare Parts: 1x12V5W (W5W)
				
Astra Mk IV (G) Astra Mk IV (G)	02/98->	1LG 007 640-331 1LG 007 640-341 6NM 007 878-351 8GH 005 635-121 8GH 007 157-121 8GA 006 841-121 8GP 003 594-121	1 1 1 1 1 1 1	FF®-H7/HB3 headlight, left, with body/lens for indicator light FF®-H7/HB3 headlight, right, with body/lens for indicator light Accessories: Headlight levelling actuator Spare Parts: 1x12V60W (HB3) 1x12V55W (H7) 1x12V21W (PY21W) 1x12V5W (W5W)
				
Astra Mk IV, CC, Estate Special models Astra Mk IV Coupé Astra Mk IV Convertible	02/98-> 03/00-> 03/01->	1LG 007 640-631 1LG 007 640-641 6NM 007 878-351 8GH 005 635-121 8GH 007 157-121 8GA 006 841-121 8GP 003 594-121	1 1 1 1 1 1 1	FF®-H7/HB3 headlight, left, with body/lens for indicator light and black frame behind the cover lens FF®-H7/HB3 headlight, right, with body/lens for indicator light and black frame behind the cover lens Accessories: Headlight levelling actuator Spare Parts: 1x12V60W (HB3) 1x12V55W (H7) 1x12V21W (PY21W) 1x12V5W (W5W)
				
Astra Mk IV (G)	02/98->	6NM 007 878-351	1	Headlight levelling actuator
				
Astra Mk IV (G) (-) Convertible, Coupé, OPC	02/98->	1NA 009 029-011 1NA 009 029-021 8GH 002 090-133	1 1 1	FF®-H3 fog light, left, with bulb FF®-H3 fog light, right, with bulb Spare Parts: 1x12V55W (H3)
				







Manufacturer Model	Model year	Part no.	Pk.	Note
Vauxhall				
Astra Mk IV (G) Astra Mk IV (G) Hatchback	02/98->	2VP 008 863-801 2SA 008 405-021 2XA 008 221-021 2BA 008 221-041 2ZR 008 221-051 2NE 008 221-031 8RA 008 405-001 8GA 002 073-121 8GA 006 841-121	1	Design combination rearlight set with LED tail light, with 8 module lights, 2 circular ring reflector modules, 2 retaining parts, lead groups and accessories Spare Parts: 1 LED rear light 1 Stop light 1 Indicator light (grey) 1 Reverse light (grey) 1 Rear fog light 1 Reflex-reflector (red) 1 6x12V21W (P21W) 1 2x12V21W (PY21W)
				
Astra Mk V (H) Astra Mk V (H) Code GU	03/04->	1LG 270 370-331 1LG 270 370-341 8GH 007 157-121 8GH 002 089-133 8GH 008 417-001 8GP 003 594-121	1 1	FF®-H7/H1 headlight, left, with integrated indicator light, with electric headlight levelling actuator FF®-H7/H1 headlight, right, with integrated indicator light, with electric headlight levelling actuator Spare Parts: 1 1x12V55W (H7) 1 1x12V55W (H1) 1 1x12V21W (H21W) 1 1x12V5W (W5W)
				
Astra Mk V (H) Code NA	02/07->	1LG 270 370-631 1LG 270 370-641 8GH 007 157-121 8GH 002 089-133 8GH 008 417-001 8GP 003 594-121	1 1	FF®-H7/H1 headlight, left, with integrated indicator light, with electric headlight levelling actuator FF®-H7/H1 headlight, right, with integrated indicator light, with electric headlight levelling actuator Spare Parts: 1 1x12V55W (H7) 1 1x12V55W (H1) 1 1x12V21W (H21W) 1 1x12V5W (W5W)
				
Astra Mk V (H)	03/04->	5DV 008 290-004	1	Ballast unit
				
Astra Mk V (H)	03/04->	5DD 008 319-501	1	Ignitor, gas discharge bulb
				







Manufacturer Model	Model year	Part no.	Pk.	Note
Vauxhall				
Astra Mk V (H)		1NA 010 503-011	1	FF®-H3 fog light, left, with bulb
Astra Mk V (H)	03/04->	1NA 010 503-021	1	FF®-H3 fog light, right, with bulb
up to chassis no. 72094718 75086479 78048187		8GH 002 090-133	1	Spare Parts: 1x12V55W (H3)
(-) VXR				
				
Astra Mk V (H) Hatchback 5-doors	03/04->01/07	2PT 009 305-821	1	Daytime running light set, 2 daytime running lights with bulbs, with harness and covers
Astra Mk V (H) Estate	08/04->01/07	2PT 008 935-001	1	Spare Parts: Daytime running light
				
Astra Mk V (H) Hatchback 5-doors	03/04->02/07	9EL 160 467-011	1	Body/lens for combination rearlight, left, with rear fog and reverse light
		9EL 160 468-011	1	Body/lens for combination rearlight, right, with rear fog and reverse light
up to chassis no. 72094718, 75086479, 78048187		8GA 006 841-121	1	Spare Parts: 1x12V21W (PY21W)
		8GA 002 073-121	1	2x12V21W (P21W)
				
Astra Mk V (H) Hatchback 5-doors	03/07->	9EL 354 073-011	1	Body/lens for combination rearlight, left, with rear fog and reverse light
		9EL 354 073-021	1	Body/lens for combination rearlight, right, with rear fog and reverse light
from chassis no. 72094719, 75086480, 78048188, 8B000001		8GA 006 841-121	1	Spare Parts: 1x12V21W (PY21W)
		8GA 002 073-121	1	4x12V21W (P21W)
				



Manufacturer Model	Model year	Part no.	Pk.	Note
Vauxhall				
Astra Mk V (H) Astra Mk V (H) GTC 3-doors	03/05->	9EL 161 421-011 9EL 161 422-011 8GA 006 841-121 8GA 002 073-121	1 1 1 1	Body/lens for combination rearlight, left, with rear fog and reverse light Body/lens for combination rearlight, right, with rear fog and reverse light Spare Parts: 1x12V21W (PY21W) 2x12V21W (P21W)
				
Astra Mk V (H) GTC 3-doors	03/05->	2SK 008 748-801 8GA 002 073-121 8GA 006 841-121 8GA 002 073-121	1 1 1 1	Upgrade combination rearlight set (Icegrey) Spare Parts: 1x12V21W (P21W) 1x12V21W (PY21W) 3x12V21W (P21W)
				
Astra Mk VI (J) Astra Mk VI (J) Code AC5 (-) Sport, SRI	12/09->	1LG 010 011-331 1LG 010 011-341 8GH 007 157-201 8GD 008 893-002	1 1 1 1	FF®-H7 headlight, left, with daytime running light, with chrome-plated cover, with electric headlight levelling actuator, with bulbs FF®-H7 headlight, right, with daytime running light, with chrome-plated cover, with electric headlight levelling actuator, with bulbs Spare Parts: 2x12V55W (H7) Long Life 1x12V21/5W (W21/5W)
				
Astra Mk VI (J) Sport, SRI Code AB3	12/09->	1LG 010 011-391 1LG 010 011-401 8GH 007 157-201 8GD 008 893-002	1 1 1 1	FF®-H7 headlight, left, with daytime running light, with black cover, with electric headlight levelling actuator, with bulbs FF®-H7 headlight, right, with daytime running light, with black cover, with electric headlight levelling actuator, with bulbs Spare Parts: 2x12V55W (H7) Long Life 1x12V21/5W (W21/5W)
				







Manufacturer Model	Model year	Part no.	Pk.	Note
Vauxhall				
Astra Mk VI (J) Astra Mk VI (J) (+) Bi-Xenon light (+) bend lighting	12/09->	 1ZT 010 012-411 1ZT 010 012-421 8GS 009 028-021 8GH 008 358-121	1 1 1 1	Bi-Xenon®/FF®-H11 headlight, left, with daytime running light, with dynamic bend lighting, with dynamic headlight levelling actuator, without xenon ballast, without gas discharge bulb, with bulbs Bi-Xenon®/FF®-H11 headlight, right, with daytime running light, with dynamic bend lighting, with dynamic headlight levelling actuator, without xenon ballast, without gas discharge bulb, with bulbs Spare Parts: 1x35W (D1S) 1x12V55W (H11)
Carlton Mk I Carlton Mk I	11/82->09/86	 2KA 003 485-021 8GA 002 071-131	1 1	Licence plate light with bulb Spare Parts: 1x12V10W (R10W)
Cavalier Mk II Cavalier Mk II	81->84	 2KA 003 485-021 8GA 002 071-131	1 1	Licence plate light with bulb Spare Parts: 1x12V10W (R10W)
Cavalier Mk III Cavalier Mk III from chassis no. R1000001, R5000001, R7000001	09/93->09/95	 9EL 146 021-001 8GA 002 073-121	1 1	Body/lens for indicator light (white), left Spare Parts: 1x12V21W (P21W)
Cavalier Mk III	10/88->09/95	 2BM 003 563-111 8GP 003 594-121	1 1	Auxiliary indicator light Spare Parts: 1x12V5W (W5W)







Vauxhall



Manufacturer Model	Model year	Part no.	Pk.	Note
Vauxhall				
Corsa Mk II (B) Corsa Mk II (B) up to chassis no. 33999999, 34999999, 36999999	10/00->	1NA 009 031-011 1NA 009 031-021 8GH 002 090-133	1 1 1	FF®-H3 fog light, left, with bulb FF®-H3 fog light, right, with bulb Spare Parts: 1x12V55W (H3)
				
Corsavan Mk II (B) Corsavan Mk II (B) up to chassis no. 33999999, 34999999, 36999999	10/00->	1NA 009 031-011 1NA 009 031-021 8GH 002 090-133	1 1 1	FF®-H3 fog light, left, with bulb FF®-H3 fog light, right, with bulb Spare Parts: 1x12V55W (H3)
				
Insignia Insignia Code NR	07/08->	1LJ 009 630-331 1LJ 009 630-341 8GH 007 157-121 8GH 002 089-133 8GA 006 841-121 8GD 008 893-002	1 1 1 1 1 1	FF®-H7/H1 headlight, left, with indicator light, with daytime running light, with electric headlight levelling actuator, with bulbs FF®-H7/H1 headlight, right, with indicator light, with daytime running light, with electric headlight levelling actuator, with bulbs Spare Parts: 1x12V55W (H7) 1x12V55W (H1) 1x12V21W (PY21W) 1x12V21/5W (W21/5W)
				
Insignia (+) Bi-Xenon light (+) bend lighting	07/08->	1ZT 009 631-311 1ZT 009 631-321 8GS 009 028-021 8GH 008 358-121 8GA 006 841-121	1 1 1 1 1	Bi-Xenon®/H11 headlight, left, with indicator light, with daytime running light, with dynamic bend lighting, with electric headlight levelling actuator, without xenon ballast, without gas discharge bulb, with bulbs Bi-Xenon®/H11 headlight, right, with indicator light, with daytime running light, with dynamic bend lighting, with electric headlight levelling actuator, without xenon ballast, without gas discharge bulb, with bulbs Accessories: 1x35W (D1S) Spare Parts: 1x12V55W (H11) 1x12V21W (PY21W)
				







Manufacturer Model	Model year	Part no.	Pk.	Note
Vauxhall				
Insignia Insignia Estate	07/08->	9EL 354 668-031	1	Body/lens for combination rearlight, left, with reverse light
		9EL 354 668-041	1	Body/lens for combination rearlight, right, with rear fog light
		8GP 003 594-121	1	1x12V5W (W5W)
		8GA 002 073-271	1	1x12V21W (P21W)
		8GA 006 841-121	1	1x12V21W (PY21W)
		8GH 008 417-001	1	2x12V21W (H21W)
				Accessories:
				1x12V5W (W5W)
				1x12V21W (P21W)
				1x12V21W (PY21W)
				2x12V21W (H21W)
Nova	03/83->02/93	2BM 003 563-111	1	Auxiliary indicator light
Nova	03/83->02/93	8GP 003 594-121	1	Spare Parts: 1x12V5W (W5W)
				
Nova	03/83->02/93	2KA 003 485-021	1	Licence plate light with bulb
		8GA 002 071-131	1	Spare Parts: 1x12V10W (R10W)
				
Omega (B) Omega (B) Code YX up to chassis no. V1991158	03/94->08/97	1LG 006 920-231	1	H1 headlight, left, with indicator light, suitable for electric headlight leveller
		1LG 006 920-241	1	H1 headlight, right, with indicator light, suitable for electric headlight leveller
		6NM 007 282-641	1	Accessories: Headlight levelling actuator
		8GH 002 089-133	1	Spare Parts: 2x12V55W (H1) UV-Cut
		8GA 002 073-121	1	1x12V21W (P21W)
		8GP 003 594-121	1	1x12V5W (W5W)
				
Omega (B) Code FL Chassis no. W1000001 -> X1999999	09/97->09/99	1LL 007 950-251	1	Xenon/H7 headlight, left, with body/lens for indicator light, without headlight levelling actuator, without xenon ballast, without gas discharge bulb, without bulbs
		1LL 007 950-261	1	Xenon/H7 headlight, right, with body/lens for indicator light, without headlight levelling actuator, without xenon ballast, without gas discharge bulb, without bulbs
		5DV 007 760-651	1	Accessories: Ballast unit
		8GS 007 949-101	1	Spare Parts: 1x35W (D2S)
		8GH 007 157-121	1	1x12V55W (H7)
		8GA 006 841-121	1	1x12V21W (PY21W)
		8GP 003 594-121	1	1x12V5W (W5W)
				



Manufacturer Model	Model year	Part no.	Pk.	Note
Vauxhall				
Omega (B)		1LL 009 020-231	1	DE®-H1/H7 headlight, left, with body/lens for indicator light
Omega (B)	10/99->	1LL 009 020-241	1	DE®-H1/H7 headlight, right, with body/lens for indicator light
Code FN				Accessories: Headlight levelling actuator
Chassis no. Y1000001 -> 11999999, 21000001 ->		6NM 007 282-641	1	Spare Parts: 1x12V55W (H1) 1x12V55W (H7) 1x12V21W (PY21W) 1x12V5W (W5W)
		8GH 002 089-133 8GH 007 157-121 8GA 006 841-121 8GP 003 594-121	1 1 1 1	
Omega (B)	03/94->07/03	6NM 007 282-641	1	Headlight levelling actuator (for halogen headlight)
				
Omega (B)	09/97->07/03	5DV 007 760-651	1	Ballast unit
				
Omega (B) Estate	03/94->09/99	9EL 143 579-021	1	Body/lens for combination rearlight, left, with rear fog and reverse light
		9EL 143 580-021	1	Body/lens for combination rearlight, right, with rear fog and reverse light
		8GD 004 772-121 8GA 006 841-121 8GA 002 073-121	1 1 1	Spare Parts: 1x12V21/4W (P21/4W) 1x12V21W (PY21W) 2x12V21W (P21W)
				
Omega (B) Estate	03/94->09/99	8RA 007 051-031	1	Reflex-reflector, left
		8RA 007 051-041	1	Reflex-reflector, right
				
Omega (B) Estate	10/99->07/03	9EL 152 051-011	1	Body/lens for combination rearlight, left, with rear fog and reverse light
		9EL 152 052-011	1	Body/lens for combination rearlight, right, with rear fog and reverse light
		8GD 004 772-121 8GA 006 841-121 8GA 002 073-121	1 1 1	Spare Parts: 1x12V21/4W (P21/4W) 1x12V21W (PY21W) 2x12V21W (P21W)
				



Manufacturer Model	Model year	Part no.	Pk.	Note
Vauxhall				
Signum Signum	05/03->08/05		1LL 008 320-251 1LL 008 320-261 8GH 007 157-121 8GP 003 594-121 8GA 006 841-121	1 DE@-H7/FF@-H7 headlight, left, with indicator light, suitable for headlight leveller 1 DE@-H7/FF@-H7 headlight, right, with indicator light, suitable for headlight leveller Spare Parts: 1 2x12V55W (H7) 1 1x12V5W (W5W) 1 1x12V21W (PY21W)
Signum	04->08/05		1LL 008 320-331 1LL 008 320-341 8GH 007 157-121 8GP 003 594-121 8GA 006 841-121	1 DE@-H7/FF@-H7 headlight (black), left, with indicator light, suitable for headlight leveller 1 DE@-H7/FF@-H7 headlight (black), right, with indicator light, suitable for headlight leveller Spare Parts: 1 2x12V55W (H7) 1 1x12V5W (W5W) 1 1x12V21W (PY21W)
Vectra Mk II Vectra Mk II Code GB, BJ up to chassis no. 51999999, 58999999	04/02->08/05		1LL 008 320-251 1LL 008 320-261 8GH 007 157-121 8GP 003 594-121 8GA 006 841-121	1 DE@-H7/FF@-H7 headlight, left, with indicator light, suitable for headlight leveller 1 DE@-H7/FF@-H7 headlight, right, with indicator light, suitable for headlight leveller Spare Parts: 1 2x12V55W (H7) 1 1x12V5W (W5W) 1 1x12V21W (PY21W)
Vectra Mk II up to chassis no. 51999999, 58999999	04/02->08/05		1LL 008 320-331 1LL 008 320-341 8GH 007 157-121 8GP 003 594-121 8GA 006 841-121	1 DE@-H7/FF@-H7 headlight (black), left, with indicator light, suitable for headlight leveller, for conversion 1 DE@-H7/FF@-H7 headlight (black), right, with indicator light, suitable for headlight leveller, for conversion Spare Parts: 1 2x12V55W (H7) 1 1x12V5W (W5W) 1 1x12V21W (PY21W)



Vauxhall - Volkswagen



Manufacturer Model	Model year	Part no.	Pk.	Note
Vauxhall				
Vectra Mk II Vectra Mk II up to chassis no. 51999999, 58999999	04/02->08/05	1LL 008 320-331 1LL 008 320-341 8GH 007 157-121 8GP 003 594-121 8GA 006 841-121	1 1 1 1 1	DE®-H7/FF®-H7 headlight (black), left, with indicator light, suitable for headlight leveller DE®-H7/FF®-H7 headlight (black), right, with indicator light, suitable for headlight leveller Spare Parts: 2x12V55W (H7) 1x12V5W (W5W) 1x12V21W (PY21W)
				
Zafira Mk I (A) Zafira Mk I (A) (-) GSi, OPC	04/99->06/05	1NA 009 033-011 1NA 009 033-021 8GH 002 090-133	1 1 1	FF®-H3 fog light, left, with bulb FF®-H3 fog light, right, with bulb Spare Parts: 1x12V55W (H3)
				
Zafira Mk II (B) Zafira Mk II (B) up to chassis no. 72095156, 7G066981 (-) VXR	07/05->	1NA 010 503-011 1NA 010 503-021 8GH 002 090-133	1 1 1	FF®-H3 fog light, left, with bulb FF®-H3 fog light, right, with bulb Spare Parts: 1x12V55W (H3)
				
Volkswagen				
Amarok Amarok	09/10->	1N0 271 295-031 1N0 271 295-041 8GH 005 636-121	1 1 1	FF®-HB4 fog light, left, with bulb FF®-HB4 fog light, right, with bulb Spare Parts: 1x12V51W (HB4)
				
Bora (1J2, 1J6) Bora (1J2, 1J6)	10/98->07/05	9EL 156 099-801 8GP 003 594-541	1 1	Body/lens set for auxiliary indicator light (clear), with 2 amber bulbs Spare Parts: 2x12V5W (WY5W)
				



Manufacturer Model	Model year	Part no.	Pk.	Note
Volkswagen				
Bora (1J2, 1J6) Bora (1J2, 1J6) (-) Estate Basic, Trendline, Comfortline	10/98->07/05	9EL 963 669-081 9EL 963 670-081 8GA 002 071-121 8GA 002 073-121	1 1 1 1	Body/lens for combination rearlight (red/clear), left, with rear fog and reverse light Body/lens for combination rearlight (red/clear), right, with rear fog and reverse light Accessories: 1x12V5W (R5W) 4x12V21W (P21W)
				
Bora (1J2, 1J6) (-) Estate	10/98->07/05	9EL 963 561-801 8RA 004 412-041 8GA 002 071-121 8GA 002 073-121	1 10 1 1	Design combination rearlight set (black) without bulb holder Spare Parts: Reflex-reflector (red) Accessories: 2x12V5W (R5W) 8x12V21W (P21W)
				
Bora (1J2, 1J6) (-) Estate	10/98->07/05	9EL 963 561-811 8RA 004 412-041 8GA 002 071-121 8GA 002 073-121	1 10 1 1	Design combination rearlight set (brilliant silver) without bulb holder Spare Parts: Reflex-reflector (red) Accessories: 2x12V5W (R5W) 8x12V21W (P21W)
				
Caddy I (14) Caddy I (14)	08/82->07/92	1L8 003 060-561 9GH 116 966-011 9FF 126 444-001 8GD 002 088-131 8GP 002 067-121 1L8 003 060-691 9GH 116 966-011 9FF 126 444-001 8GJ 002 525-131 8GP 002 067-121	1 10 10 1 1 1 10 10 1 1	Headlight Spare Parts: Cap Bulb socket for side light (to be ordered separately) 1x12V45/40W (R2) 1x12V4W (T4W) H4 headlight Spare Parts: Cap Bulb socket for side light (to be ordered separately) 1x12V60/55W (H4) 1x12V4W (T4W)
				





Volkswagen



Manufacturer Model	Model year	Part no.	Pk.	Note
Volkswagen				
Caddy I (14) Caddy I (14)	08/82->07/92	 2BA 002 939-171 9EL 116 771-031 8GA 002 073-121	1 2 1	Indicator light (amber) Spare Parts: Lens Accessories: 1x12V21W (P21W)
Caddy II (9KA9, 9K9B, 9U7) Caddy II Pick-up (9U7)	09/96->12/00	 9EL 246 151-021 9EL 246 152-021 8GA 006 841-121	1 1 1	Body/lens for indicator light (white), left Body/lens for indicator light (white), right Accessories: 1x12V21W (PY21W)
Caddy II (9KA9, 9K9B, 9U7)	11/95->	 9EL 147 073-001 8GP 003 594-121	2 1	Body/lens for auxiliary indicator light (amber) Accessories: 1x12V5W (W5W)
Caddy III (2K_, 2CA, 2CH) Caddy III (2K_, 2CA, 2CH) up to chassis no. 2K-B-5000	03/04->08/10	 1LL 010 203-031 1LL 010 203-041 8GH 007 157-121 8GH 002 089-133 8GA 006 841-121 8GP 003 594-121	1 1 1 1 1 1 1	H1/H7 headlight, left, with indicator light, with electric headlight levelling actuator H1/H7 headlight, right, with indicator light, with electric headlight levelling actuator Spare Parts: 1x12V55W (H7) 1x12V55W (H1) 1x12V21W (PY21W) 1x12V5W (W5W)
Caddy III (2K_, 2CA, 2CH) from chassis no. 2K-B-200 001	09/10->	 1LL 010 551-031 1LL 010 551-041 8GJ 002 525-131 8GA 006 841-121 8GA 002 073-121	1 1 1 1 1 1	FF@-H4 headlight, left, with indicator light, with daytime running light, with electric headlight levelling actuator, with bulbs FF@-H4 headlight, right, with indicator light, with daytime running light, with electric headlight levelling actuator, with bulbs Spare Parts: 1x12V60/55W (H4) 1x12V21W (PY21W) 1x12V21W (P21W)
Caddy III (2K_, 2CA, 2CH) up to chassis no. 2K-5-060 000	03/04->12/04	 1N0 270 596-051 1N0 270 596-061 8GH 008 358-121	1 1 1	DE@-H11 fog light, left, with bulb DE@-H11 fog light, right, with bulb Spare Parts: 1x12V55W (H11)



Manufacturer Model	Model year	Part no.	Pk.	Note
Volkswagen				
Caddy III (2K_, 2CA, 2CH)		1N0 271 289-031	1	FF®-HB4 fog light, left, with bulb
Caddy III (2K_, 2CA, 2CH)	12/04->08/10	1N0 271 289-041	1	FF®-HB4 fog light, right, with bulb
Chassis no. 2K-5-060 001 -> 2K-B-5000		8GH 005 636-121	1	Spare Parts: 1x12V51W (HB4)
				
Caddy III (2K_, 2CA, 2CH)	03/04->08/10	2VP 354 043-011	1	Combination rearlight, left, with rear fog and reverse light
Vehicles with tailgate		2VP 354 043-021	1	Combination rearlight, right, with rear fog and reverse light
up to chassis no. 2K-B-5000		8GD 004 772-121	1	Accessories: 1x12V21/4W (P21/4W)
		8GA 002 073-121	1	2x12V21W (P21W)
		8GA 006 841-121	1	1x12V21W (PY21W)
				
Corrado (53I)		1NB 005 394-051	1	H3 fog light, left
Corrado (53I)	09/88->07/91	1NB 005 394-061	1	H3 fog light, right
		8GH 002 090-133	1	Accessories: 1x12V55W (H3)
				
Corrado (53I)	09/88->08/91	2BM 003 647-021	1	Auxiliary indicator light (amber)
all models with auxiliary indicators as standard feature		8GP 003 594-121	1	Accessories: 1x12V5W (W5W)
				
Corrado (53I)	09/91->12/95	2BM 003 647-801	1	Auxiliary indicator light set (amber), with bulbs
		2BM 003 647-021	1	Spare Parts: Auxiliary indicator light (amber)
		8GP 003 594-121	1	2x12V5W (W5W)
				
Corrado (53I)	09/91->12/95	2BM 006 759-001	5	Auxiliary indicator light (grey), with bulb
		8GP 003 594-121	1	Spare Parts: 1x12V5W (W5W)
				











Manufacturer Model	Model year	Part no.	Pk.	Note
Volkswagen				
Eos (1F7) Eos (1F7)	05/06->10/10	1N0 271 289-031 1N0 271 289-041 8GH 005 636-121	1 1 1	FF®-HB4 fog light, left, with bulb FF®-HB4 fog light, right, with bulb Spare Parts: 1x12V51W (HB4)
				
Eos (1F7)	05/06->10/10	2VA 009 246-091 2VA 009 246-101	1 1	LED combination rearlight, left, outer part (clear/red) LED combination rearlight, right, outer part (clear/red)
				
Eos (1F7)	05/06->10/10	2VA 009 246-131 2VA 009 246-141	1 1	LED combination rearlight, left, outer part (cherry-red) LED combination rearlight, right, outer part (cherry-red)
				
Eos (1F7)	05/06->10/10	2ZR 009 247-111 2NR 009 247-121 8GA 002 073-121	1 1 1	Combination rearlight, left, inner part (clear/red), with reverse light, with bulb Combination rearlight, right, inner part (clear/red), with rear fog light, with bulb Spare Parts: 1x12V21W (P21W)
				
Eos (1F7)	05/06->10/10	2ZR 009 247-151 2NR 009 247-161 8GA 002 073-121	1 1 1	Combination rearlight, left, inner part (cherry-red), with reverse light, with bulb Combination rearlight, right, inner part (cherry-red), with rear fog light, with bulb Spare Parts: 1x12V21W (P21W)
				
Fox (5Z1, 5Z3) Fox (5Z1, 5Z3)	04/05->	1N0 270 255-051 1N0 270 255-061 8GH 002 090-133	1 1 1	FF®-H3 fog light, left, with bulb FF®-H3 fog light, right, with bulb Spare Parts: 1x12V55W (H3)
				







Manufacturer Model	Model year	Part no.	Pk.	Note
Volkswagen				
Golf I (17, 155)		1L8 003 060-561	1	Headlight
Golf I (17)	07/74->07/83	9GH 116 966-011	10	Spare Parts: Cap Bulb socket for side light 1x12V45/40W (R2) 1x12V4W (T4W)
Golf I Convertible (155)	05/79->07/87	9FF 126 444-001	10	
		8GD 002 088-131	1	
		8GP 002 067-121	1	
		1L8 003 060-691	1	H4 headlight
		9GH 116 966-011	10	Spare Parts: Cap Bulb socket for side light (to be ordered separately) 1x12V60/55W (H4) 1x12V4W (T4W)
		9FF 126 444-001	10	
		8GJ 002 525-131	1	
		8GP 002 067-121	1	
Golf I Convertible (155)	09/91->08/93	2BM 003 647-801	1	Auxiliary indicator light set (amber), with bulbs
		2BM 003 647-021	1	Spare Parts: Auxiliary indicator light (amber) 2x12V5W (W5W)
		8GP 003 594-121	1	
Golf I Convertible (155)	09/91->08/93	2BM 006 759-001	5	Auxiliary indicator light (grey), with bulb
		8GP 003 594-121	1	Spare Parts: 1x12V5W (W5W)
Golf I (17)	10/78->07/83	2KA 002 445-111	1	Licence plate light
Golf I Convertible (155)	05/79->08/93	8GP 002 067-121	1	Accessories: 1x12V4W (T4W)
Golf I (17)	07/74->07/83	2JA 002 532-011	5	Interior light
		8GM 002 091-131	1	Accessories: 1x12V10W (K)
Golf II (19E, 1G1)		1L8 004 190-111	1	H4 headlight for vehicles with or without headlight leveller
Golf II (19E, 1G1)	08/83->12/92	9GH 116 966-011	10	Spare Parts: Cap Bulb socket for side light ->05/89 (to be ordered separately) 1x12V60/55W (H4) 1x12V4W (T4W)
(-) Golf Rallye		9FF 126 444-001	10	
		8GJ 002 525-131	1	
		8GP 002 067-121	1	



Manufacturer Model	Model year	Part no.	Pk.	Note
Volkswagen				
Golf II (19E, 1G1)		1NL 006 315-051	1	DE®-H3 fog light, left, with bulb
Golf II (19E, 1G1) GL, GT, GTI	09/89->12/92	1NL 006 315-061	1	DE®-H3 fog light, right, with bulb
		8GH 002 090-133	1	Spare Parts: 1x12V55W (H3)
Golf II (19E, 1G1) C, CL	08/83->12/92	2BA 002 939-171	1	Indicator light (amber)
Golf II (19E, 1G1) GL, GT, GTI	08/83->08/89	9EL 116 771-031	2	Spare Parts: Lens
		8GA 002 073-121	1	Accessories: 1x12V21W (P21W)
Golf II GL, GT, GTI	09/89->12/92	9EL 141 701-001	2	Body/lens for indicator light (amber), left
		9EL 141 702-001	2	Body/lens for indicator light (amber), right
		8GA 002 073-121	1	Accessories: 1x12V21W (P21W)
Golf II GL, GT, GTI	09/89->12/92	2BA 006 728-801	1	Indicator light set (white), with bulbs
		8GA 002 073-121	1	Spare Parts: 2x12V21W (P21W)
				
Golf II	08/83->12/92	2BM 003 647-801	1	Auxiliary indicator light set (amber), with bulbs
		2BM 003 647-021	1	Spare Parts: Auxiliary indicator light (amber)
		8GP 003 594-121	1	2x12V5W (W5W)
Golf II	08/83->12/92	2BM 006 759-001	5	Auxiliary indicator light (grey), with bulb
		8GP 003 594-121	1	Spare Parts: 1x12V5W (W5W)
				
Golf III (1H1, 1H5, 1E7)		1LJ 007 235-251	1	H4 headlight, left, for vehicles with or without headlight leveller
Golf III	01/94->08/97	1LJ 007 235-261	1	H4 headlight, right, for vehicles with or without headlight leveller
Golf III Estate	01/94->04/99	6NM 007 282-211	1	Accessories: Headlight levelling actuator
(-) GT, GTI, VR6		8GJ 002 525-131	1	1x12V60/55W (H4)
		8GP 003 594-121	1	Spare Parts: 1x12V5W (W5W)











Manufacturer Model	Model year	Part no.	Pk.	Note
Volkswagen				
Golf III (1H1, 1H5, 1E7)		1LJ 006 360-671	1	H1 headlight, left, for vehicles with or without headlight leveller
Golf III GT, GTI, VR6	08/91->08/97	1LJ 006 360-681	1	H1 headlight, right, for vehicles with or without headlight leveller
Golf III Convertible	07/93->05/98			Accessories: Headlight levelling actuator
Golf III Estate GT, GTI, VR6	07/93->04/99	6NM 007 282-211	1	Spare Parts: Lead with adapter for vehicles ->12/92 (to be ordered separately)
		8KA 146 152-001	2	
		8GH 002 089-133	1	Accessories: 2x12V55W (H1)
		8GP 003 594-121	1	Spare Parts: 1x12V5W (W5W)
				
Golf III	08/91->08/97	6NM 007 282-211	1	Headlight levelling actuator
Golf III Convertible	07/93->05/98			
Golf III Estate	07/93->04/99			
				
Golf III Convertible	06/98->06/02	6NM 007 878-041	1	Headlight levelling actuator
				
Golf III	08/91->08/97	1LL 009 213-031	1	DE®-H7/FF®-H7 headlight, left (Upgrade) with clear glass design, with CELIS® position lights and bulbs
Golf III Convertible	07/93->05/98	1LL 009 213-041	1	DE®-H7/FF®-H7 headlight, right (Upgrade) with clear glass design, with CELIS® position lights and bulbs
Golf III Estate	07/93->04/99			
		8GH 007 157-121	1	Spare Parts: 2x12V55W (H7)
				
		Design		
Golf III Convertible	06/98->06/02	1LJ 009 292-821	1	Upgrade headlight set with up-to-date look, with clear glass design, with chrome-plated covers, with bulbs
		8GH 007 157-121	1	Spare Parts: 4x12V55W (H7)
		8GH 008 417-001	1	2x12V21W (H21W)
		8GP 003 594-121	1	2x12V5W (W5W)
				
		Design		







Manufacturer Model	Model year	Part no.	Pk.	Note
Volkswagen				
Golf III (1H1, 1H5, 1E7) Golf III Convertible	06/98->06/02	 1LL 009 300-831 1LL 009 300-071 1LL 009 300-081 8GH 007 157-121 8GH 008 356-121	1 1 1 1 1	Upgrade headlight set with CELIS® position light rings, with fog lights, with bulbs Spare Parts: Upgrade headlight, left, with fog light, with bulbs Upgrade headlight, right, with fog light, with bulbs 4x12V55W (H7) 2x12V35W (H8)
Golf III Golf III Convertible Golf III Estate	08/91->08/97 07/93->05/98 07/93->04/99	 1NL 007 220-031 1NL 007 220-041 8GH 002 090-133	1 1 1	DE®-H3 fog light, left DE®-H3 fog light, right Accessories: 2x12V55W (H3)
Golf III CL, GL Golf III Estate CL, GL	08/91->08/97 07/93->04/99	 9EL 144 425-001 9EL 144 426-001 8GA 002 073-121	1 1 1	Body/lens for indicator light (amber), left Body/lens for indicator light (amber), right Accessories: 1x12V21W (P21W)
Golf III GT, GTI, VR6 Golf III Convertible Golf III Estate GT, GTI, VR6	08/91->08/97 07/93->05/98 07/93->04/99	 9EL 144 425-011 9EL 144 426-011 8GA 002 073-121	1 1 1	Body/lens for indicator light (white), left Body/lens for indicator light (white), right Accessories: 1x12V21W (P21W)
Golf III Golf III Convertible Golf III Estate	08/91->08/97 07/93->05/98 07/93->04/99	 2BA 007 177-801 2BA 007 177-011 2BA 007 177-021 8XU 144 427-011 8XU 144 428-011 8GA 006 841-121	1 1 1 1 1 1	Indicator light set (black), with bulbs, with two covers Spare Parts: Indicator light (black), left Indicator light (black), right Cover (black), left Cover (black), right 2x12V21W (PY21W)
Golf III Golf III Convertible Golf III Estate	08/91->08/97 07/93->05/98 07/93->04/99	 8XU 144 427-001 8XU 144 428-001	2 2	Large cover (silver), left Large cover (silver), right (next to indicator light)







Manufacturer Model	Model year	Part no.	Pk.	Note
Volkswagen				
Golf III (1H1, 1H5, 1E7)		8XU 144 429-001	1	Small cover (silver), left
Golf III	08/91->08/97	8XU 144 430-001	1	Small cover (silver), right (between indicator and fog light)
Golf III Convertible	07/93->05/98			
Golf III Estate	07/93->04/99			
				
Golf III	08/91->08/95	9EL 144 431-001	2	Body/lens for auxiliary indicator light (amber)
				
		8GP 003 594-121	1	Accessories: 1x12V5W (W5W)
Golf III	08/91->08/95	9EL 144 431-801	1	Body/lens set for auxiliary indicator light (black)
				
		8GP 003 594-121	1	Accessories: 2x12V5W (W5W)
				
Golf III	09/95->04/99	9EL 147 073-001	2	Body/lens for auxiliary indicator light (amber)
				
		8GP 003 594-121	1	Accessories: 1x12V5W (W5W)
Golf III	09/95->04/99	9EL 147 073-801	1	Body/lens set for auxiliary indicator light (grey)
				
		8GP 003 594-121	1	Accessories: 2x12V5W (W5W)
				
Golf III CL, GL	08/91->08/97	9EL 139 137-061	1	Body/lens for combination rearlight (amber/red), left, with rear fog and reverse light
				
		9EL 139 138-061	1	Body/lens for combination rearlight (amber/red), right, with rear fog and reverse light
		9EL 139 137-051	1	Body/lens for combination rearlight (amber/red), left, with reverse light
		9EL 139 138-051	1	Body/lens for combination rearlight (amber/red), right, with reverse light
		8GA 002 071-121	1	Accessories: 1x12V5W (R5W)
		8GA 002 073-121	1	4x12V21W (P21W)



Manufacturer Model	Model year	Part no.	Pk.	Note
Volkswagen				
Golf III (1H1, 1H5, 1E7) Golf III CL, GL	08/91->08/97	9EL 139 137-081 9EL 139 138-081 9EL 139 137-071 9EL 139 138-071 8GA 002 071-121 8GA 002 073-121	1 1 1 1 1 1	Body/lens for combination rearlight (grey/red), left, with rear fog and reverse light Body/lens for combination rearlight (grey/red), right, with rear fog and reverse light Body/lens for combination rearlight (grey/red), left, with reverse light Body/lens for combination rearlight (grey/red), right, with reverse light Accessories: 1x12V5W (R5W) 4x12V21W (P21W)
 Design				
Golf III GT, GTI, VR6 Golf III Convertible	08/91->08/97 07/93->06/02	9EL 139 137-081 9EL 139 138-081 9EL 139 137-071 9EL 139 138-071 8GA 002 071-121 8GA 002 073-121	1 1 1 1 1 1	Body/lens for combination rearlight (grey/red), left, with rear fog and reverse light Body/lens for combination rearlight (grey/red), right, with rear fog and reverse light Body/lens for combination rearlight (grey/red), left, with reverse light Body/lens for combination rearlight (grey/red), right, with reverse light Accessories: 1x12V5W (R5W) 4x12V21W (P21W)
				
Golf III Golf III Convertible	08/91->08/97 07/93->06/02	9EL 006 220-851 9EL 139 137-091 9EL 139 138-091 8RA 004 412-041 8GA 002 071-121 8GA 002 073-121	1 1 1 10 1 1	Design combination rearlight set (black) without bulb holder Spare Parts: Body/lens (black), left Body/lens (black), right Reflex-reflector (red) Accessories: 2x12V5W (R5W) 8x12V21W (P21W)
 Design				
Golf III Golf III Convertible	08/91->08/97 07/93->06/02	9EL 006 220-931 8RA 004 412-041 8GA 002 071-121 8GA 002 073-121	1 10 1 1	Design combination rearlight set (stratosilver) without bulb holder Spare Parts: Reflex-reflector (red) Accessories: 2x12V5W (R5W) 8x12V21W (P21W)
 Design				









Manufacturer Model	Model year	Part no.	Pk.	Note
Volkswagen				
Golf III (1H1, 1H5, 1E7)		9EL 006 220-921	1	Design combination rearlight set (red/white) without bulb holder
Golf III	08/91->08/97			
Golf III Convertible	07/93->06/02			
		8RA 004 412-041	10	Spare Parts: Reflex-reflector (red)
		8GA 002 071-121	1	Accessories: 2x12V5W (R5W)
		8GA 002 073-121	1	8x12V21W (P21W)
				Design
Golf III Estate C, CL	07/93->04/99	9EL 142 825-021	1	Body/lens for combination rearlight (amber/red), left, with rear fog and reverse light
		9EL 142 826-021	1	Body/lens for combination rearlight (amber/red), right, with rear fog and reverse light
		8GD 004 772-121	1	Accessories: 1x12V21/4W (P21/4W)
		8GA 002 073-121	1	3x12V21W (P21W)
				
Golf III Estate C, CL	07/93->04/99	9EL 142 825-031	1	Body/lens for combination rearlight (grey/red), left, with rear fog and reverse light, for conversion
		9EL 142 826-031	1	Body/lens for combination rearlight (grey/red), right, with rear fog and reverse light, for conversion
		8GD 004 772-121	1	Accessories: 1x12V21/4W (P21/4W)
		8GA 002 073-121	1	3x12V21W (P21W)
				Design
Golf III Estate GT, 'Movie'	07/93->04/99	9EL 142 825-031	1	Body/lens for combination rearlight (grey/red), left, with rear fog and reverse light
		9EL 142 826-031	1	Body/lens for combination rearlight (grey/red), right, with rear fog and reverse light
		8GD 004 772-121	1	Accessories: 1x12V21/4W (P21/4W)
		8GA 002 073-121	1	3x12V21W (P21W)
				
Golf IV (1J1, 1J5)		1LJ 009 292-821	1	Upgrade headlight set with up-to-date look, with clear glass design, with chrome-plated covers, with bulbs
Golf IV	08/97->06/06			
		6NM 007 878-041	1	Accessories: Headlight levelling actuator
		8GH 007 157-121	1	Spare Parts: 4x12V55W (H7)
		8GH 008 417-001	1	2x12V21W (H21W)
		8GP 003 594-121	1	2x12V5W (W5W)
				Design



Volkswagen



Manufacturer Model	Model year	Part no.	Pk.	Note
Volkswagen				
Golf IV (1J1, 1J5) Golf IV	08/97->06/06	 <p>1LL 009 300-831 6NM 007 878-041 1LL 009 300-071 1LL 009 300-081 8GH 007 157-121 8GH 008 356-121</p>	1 1 1 1 1 1	<p>Upgrade headlight set with CELIS® position light rings, with fog lights, with bulbs</p> <p>Accessories: Headlight levelling actuator</p> <p>Spare Parts: Upgrade headlight, left, with fog light, with bulbs Upgrade headlight, right, with fog light, with bulbs 4x12V55W (H7) 2x12V35W (H8)</p>
Golf IV	08/97->06/06	 <p>6NM 007 878-041</p>	1	<p>Headlight levelling actuator (for H7/H1 headlight)</p>
Golf IV (-) GTI, TDI	08/97->06/06	 <p>1NL 008 383-821 1NL 008 090-031 9HD 149 253-007 8JD 156 150-807 8GH 002 090-133</p>	1 1 1 1 1	<p>Micro DE®-H3 fog light set with bulbs, with covers</p> <p>Spare Parts: Micro DE®-H3 fog light Cap Counterplug set (to be ordered separately) 2x12V55W (H3)</p>
Golf IV	08/97->06/06	 <p>2PT 009 305-811 2PT 008 935-011</p>	1 1	<p>Daytime running light set, with harness and retaining parts</p> <p>Spare Parts: Daytime running light</p>
Golf IV	08/97->06/06	 <p>9EL 156 099-801 8GP 003 594-541</p>	1 1	<p>Body/lens set for auxiliary indicator light (clear), with 2 amber bulbs</p> <p>Spare Parts: 2x12V5W (WY5W)</p>
Golf IV (-) Estate Basic	08/97->06/05	 <p>9EL 151 875-021 9EL 151 876-021 8GA 002 071-131 8GA 002 073-121</p>	1 1 1 1	<p>Body/lens for combination rearlight (amber/red), left, with rear fog and reverse light</p> <p>Body/lens for combination rearlight (amber/red), right, with rear fog and reverse light</p> <p>Accessories: 1x12V10W (R10W) 4x12V21W (P21W)</p>



Manufacturer Model	Model year	Part no.	Pk.	Note
Volkswagen				
Golf IV (1J1, 1J5) Golf IV (-) Estate Basic	08/97->06/05	9EL 148 179-031 9EL 148 180-031 8GA 002 071-131 8GA 002 073-121	1 1 1 1	Body/lens for combination rearlight (grey/red), left, with rear fog and reverse light, for conversion Body/lens for combination rearlight (grey/red), right, with rear fog and reverse light, for conversion Accessories: 1x12V10W (R10W) 4x12V21W (P21W)
				
Golf IV (-) Estate Trendline, Comfortline, Highline, GTI, V6	08/97->06/05	9EL 148 179-031 9EL 148 180-031 8GA 002 071-131 8GA 002 073-121	1 1 1 1	Body/lens for combination rearlight (grey/red), left, with rear fog and reverse light Body/lens for combination rearlight (grey/red), right, with rear fog and reverse light Accessories: 1x12V10W (R10W) 4x12V21W (P21W)
				
Golf IV (-) Estate	08/97->06/05	9EL 148 179-021 9EL 148 180-021 8GA 002 071-131 8GA 002 073-121	1 1 1 1	Body/lens for combination rearlight (black/red), left, with rear fog and reverse light Body/lens for combination rearlight (black/red), right, with rear fog and reverse light Accessories: 1x12V10W (R10W) 4x12V21W (P21W)
				
Golf IV (-) Estate	08/97->06/05	9EL 007 720-821 9EL 007 720-831 9EL 007 720-851 9EL 148 179-101 9EL 148 180-101 9EL 148 179-131 9EL 148 180-131 8RA 004 412-041 8GA 002 071-131 8GA 002 073-121	1 1 1 1 1 1 1 1 10 1 1	Design combination rearlight set (brilliant black) without bulb holder Design combination rearlight set (blue-white brilliant) without bulb holder Design combination rearlight set (red-white brilliant) without bulb holder Spare Parts: 1 Body/lens (brilliant black), left 1 Body/lens (brilliant black), right 1 Body/lens (red-white brilliant), left 1 Body/lens (red-white brilliant), right 10 Reflex-reflector (red) Accessories: 2x12V10W (R10W) 8x12V21W (P21W)
				



Manufacturer Model	Model year	Part no.	Pk.	Note
Volkswagen				
Golf IV (1J1, 1J5) Golf IV (-) Estate	08/97->06/05	9EL 007 720-871 8GA 002 071-131 8GA 002 073-121	1 1 1	Design combination rearlight set (silver) without bulb holder Accessories: 2x12V10W (R10W) 8x12V21W (P21W)
				
Golf IV (-) Estate	08/97->06/05	9EL 008 980-801 8GA 002 071-131 8GA 002 073-121	1 1 1	Design combination rearlight set, transparent/brilliant (silver) without bulb holder Accessories: 2x12V10W (R10W) 8x12V21W (P21W)
				
Golf IV (-) Estate	08/97->06/05	9EL 008 980-811 8GA 002 071-131 8GA 002 073-121	1 1 1	Design combination rearlight set, transparent/brilliant (black) without bulb holder Accessories: 2x12V10W (R10W) 8x12V21W (P21W)
				
Golf V (1K1) Golf V (1K1)	10/03->05/04	1LG 247 007-031 1LG 247 007-041 8GH 007 157-121 8GA 006 841-121 8GP 003 594-121	1 1 1 1 1	FF®-H7 headlight, left, with indicator light, with electric headlight levelling actuator, with bulbs FF®-H7 headlight, right, with indicator light, with electric headlight levelling actuator, with bulbs Spare Parts: 2x12V55W (H7) 1x12V21W (PY21W) 1x12V5W (W5W)
				







Manufacturer Model	Model year	Part no.	Pk.	Note
Volkswagen				
Golf V (1K1) Golf V (1K1) (-) GTI	05/04->	1LG 247 007-191 1LG 247 007-201 8GH 007 157-121 8GA 006 841-121 8GP 003 594-121	1 1 1 1 1	FF®-H7 headlight, left, with indicator light, with electric headlight levelling actuator, with bulbs FF®-H7 headlight, right, with indicator light, with electric headlight levelling actuator, with bulbs Spare Parts: 2x12V55W (H7) 1x12V21W (PY21W) 1x12V5W (W5W)
Golf V GTI (1K1)	10/94->	1LG 247 007-231 1LG 247 007-241 8GH 007 157-121 8GA 006 841-121 8GP 003 594-121	1 1 1 1 1	FF®-H7 headlight (black), left, with indicator light, with electric headlight levelling actuator, with bulbs FF®-H7 headlight (black), right, with indicator light, with electric headlight levelling actuator, with bulbs Spare Parts: 2x12V55W (H7) 1x12V21W (PY21W) 1x12V5W (W5W)
Golf V (1K1)	05/04->	1LL 009 476-031 1LL 009 476-041 8GH 007 157-121 8GA 006 841-121 8GP 003 594-121	1 1 1 1 1	Upgrade headlight, left, with patterned lens, with bulbs Upgrade headlight, right, with patterned lens, with bulbs Note: For registered design reasons, the headlight may only be used to replace lenticular-shaped Golf V headlights. Spare Parts: 2x12V55W (H7) 1x12V21W (PY21W) 1x12V5W (W5W)
Golf V (1K1) up to chassis no. 1K-5B068 301 1K-5P042 726 1K-5U009 229 1K-5W127 429 (-) GT, GTI	10/03->11/04	1N0 270 595-011 1N0 270 595-021 8GH 008 358-121	1 1 1	DE®-H11 fog light, left, with bulb DE®-H11 fog light, right, with bulb Spare Parts: 1x12V55W (H11)





Manufacturer Model	Model year	Part no.	Pk.	Note
Volkswagen				
Golf V (1K1) Golf V (1K1) from chassis no. 1K-5B068 302 1K-5P042 727 1K-5U009 230 1K-5W127 430 (-) GT, GTI	11/04->	1N0 271 284-031	1	FF®-HB4 fog light, left, with bulb
		1N0 271 284-041	1	FF®-HB4 fog light, right, with bulb
		8GH 005 636-121	1	Spare Parts: 1x12V51W (HB4)
Golf V GT, GTI (1K1) (-) GT, GTI, R32	05/05->	1N0 271 295-031	1	FF®-HB4 fog light, left, with bulb
		1N0 271 295-041	1	FF®-HB4 fog light, right, with bulb
		8GH 005 636-121	1	Spare Parts: 1x12V51W (HB4)
Golf V (1K1) (-) GT, GTI, R32	10/03->	1NL 008 383-911	1	Micro DE®-H3 fog light set with bulbs, with covers and remote control system
		1NL 008 090-031	1	Spare Parts: Micro DE®-H3 fog light
		6ZN 160 705-001	1	Radio remote control system
		 8GH 002 090-133 1 2x12V55W (H3)		
Golf V (1K1) (-) GT, GTI, R32	10/03->	1N0 009 436-801	1	DynaView® Evo2 additive cornering light set, with fog light function, with covers, control unit, harness and bulbs
		1N0 009 295-011	1	Spare Parts: Fog light, left, with standard bracket and bulb
		1N0 009 295-021	1	Fog light, right, with standard bracket and bulb
		 5DF 009 244-007 24 IntelliBeam® control electronics 8GH 007 157-121 1 2x12V55W (H7)		
Golf V (1K1) (-) GT, GTI, R32	10/03->	2PT 010 177-801	1	LED daytime running light set, 2 LED daytime running lights with harness and covers
		2PT 009 599-011	1	Spare Parts: LED daytime running light, left
		2PT 009 599-021	1	LED daytime running light, right
		 8KA 165 959-001 1 Cable set		







Manufacturer Model	Model year	Part no.	Pk.	Note
Volkswagen				
Golf V (1K1) Golf V (1K1) (-) GT, GTI, R32	10/03->	 Design	2PT 009 305-801 1 2PT 008 935-001 1	Daytime running light set, 2 daytime running lights with bulbs, with harness and covers Spare Parts: Daytime running light
Golf V (1K1) (-) GT, GTI, R32	10/03->	 Design	9HB 183 460-001 1 8KA 165 959-001 1 2PT 010 458-801 1 2PT 010 458-811 1 8KB 178 139-002 25	Cover set for daytime running light set LEDayFlex with covers, assembly accessories and harness. (The LED daytime running light set is not part of scope of supply) Spare Parts: Harness Accessories: Daytime running light set without side light Daytime running light set with side light Extension lead
Golf V (1K1) up to chassis no. 1K-6-100 000 (-) R32	10/03->12/05		2SD 354 040-011 1 2SD 354 040-021 1 8GA 002 073-121 1 8GH 007 643-121 1	Combination rearlight, left, outer part Combination rearlight, right, outer part Accessories: 2x12V/21W (P21W) 1x12V6W (H6W)
Golf V (1K1)	10/03->	 Design	2VP 009 500-811 1 8GA 002 073-121 1	LED Upgrade combination rearlight set (silver/red) Spare Parts: 2x12V/21W (P21W)
Golf V (1K1) (-) GTI, R32	10/03->	 Design	2DA 010 415-001 1	Upgrade safety brake light (black)



Manufacturer Model	Model year	Part no.	Pk.	Note
Volkswagen				
Golf V Estate (1K5) Golf V Estate (1K5)	06/07->07/09	1LG 247 007-191 1LG 247 007-201 8GH 007 157-121 8GA 006 841-121 8GP 003 594-121	1 1 1 1 1	FF®-H7 headlight, left, with indicator light, with electric headlight levelling actuator, with bulbs FF®-H7 headlight, right, with indicator light, with electric headlight levelling actuator, with bulbs Spare Parts: 2x12V55W (H7) 1x12V21W (PY21W) 1x12V5W (W5W)
				
Golf V Estate (1K5)	06/07->07/09	1LL 009 476-031 1LL 009 476-041 8GH 007 157-121 8GA 006 841-121 8GP 003 594-121	1 1 1 1 1	Upgrade headlight, left, with patterned lens, with bulbs Upgrade headlight, right, with patterned lens, with bulbs Note: For registered design reasons, the headlight may only be used to replace lentil-shaped Golf V headlights. Spare Parts: 2x12V55W (H7) 1x12V21W (PY21W) 1x12V5W (W5W)
				
Golf V Estate	06/07->07/09	1N0 271 295-031 1N0 271 295-041 8GH 005 636-121	1 1 1	FF®-HB4 fog light, left, with bulb FF®-HB4 fog light, right, with bulb Spare Parts: 1x12V51W (HB4)
				
Golf V Estate	06/07->07/09	2DA 010 415-001	1	Upgrade safety brake light (black)
				
Golf VI (5K1) Golf VI (5K1) (-) GTD, GTI, Golf R	10/08->	1LG 009 901-231 1LG 009 901-241 8GH 007 157-201 8GJ 168 119-001	1 1 1 1	FF®-H7/H15 headlight, left, with indicator light, with daytime running light, with electric headlight levelling actuator, with bulbs FF®-H7/H15 headlight, right, with indicator light, with daytime running light, with electric headlight levelling actuator, with bulbs Spare Parts: 1x12V55W (H7) Long Life 1x12V55/15W (H15) 1x12V24W (PSY24W) 1x12V5W (W5W) Long Life
				



Manufacturer Model	Model year	Part no.	Pk.	Note
Volkswagen				
Golf VI (5K1) Golf VI (5K1) for PR no. 8JX (+) Bi-Xenon light (+) bend lighting	10/08->	 1ZS 009 902-531 1ZS 009 902-541 5DV 009 000-001 8GS 009 028-021	1 1 1 1	Bi-Xenon® headlight, left, with indicator light, with daytime running light, with dynamic bend lighting, with electric headlight levelling actuator, without xenon ballast, without gas discharge bulb, with bulbs Bi-Xenon® headlight, right, with indicator light, with daytime running light, with dynamic bend lighting, with electric headlight levelling actuator, without xenon ballast, without gas discharge bulb, with bulbs Accessories: Ballast unit Spare Parts: 1x35W (D1S) 1x12V21W (PY21W) Silver Vision 1x12V5W (W5W)
Golf VI (5K1)	10/08->	 5DV 009 000-001	1	Ballast unit
Golf VI Estate (AJ5) Golf VI Estate (AJ5)	07/09->	 1LG 009 901-231 1LG 009 901-241 8GH 007 157-201 8GJ 168 119-001	1 1 1 1	FF®-H7/H15 headlight, left, with indicator light, with daytime running light, with electric headlight levelling actuator, with bulbs FF®-H7/H15 headlight, right, with indicator light, with daytime running light, with electric headlight levelling actuator, with bulbs Spare Parts: 1x12V55W (H7) Long Life 1x12V55/15W (H15) 1x12V24W (PSY24W) 1x12V5W (W5W) Long Life
Golf VI Estate (AJ5) for PR no. 8JX (+) Bi-Xenon light (+) bend lighting	07/09->	 1ZS 009 902-531 1ZS 009 902-541 5DV 009 000-001 8GS 009 028-021	1 1 1 1	Bi-Xenon® headlight, left, with indicator light, with daytime running light, with dynamic bend lighting, with electric headlight levelling actuator, without xenon ballast, without gas discharge bulb, with bulbs Bi-Xenon® headlight, right, with indicator light, with daytime running light, with dynamic bend lighting, with electric headlight levelling actuator, without xenon ballast, without gas discharge bulb, with bulbs Accessories: Ballast unit Spare Parts: 1x35W (D1S) 1x12V21W (PY21W) Silver Vision 1x12V5W (W5W)



Manufacturer Model	Model year	Part no.	Pk.	Note
Volkswagen				
Golf VI Estate (AJ5) Golf VI Estate (AJ5)	07/09->	5DV 009 000-001	1	Ballast unit
				
Golf Plus (5M1, 521) Golf Plus (5M1, 521)	01/05->02/09	1LE 247 013-071	1	FF®-H7 headlight, left, with indicator light, with electric headlight levelling actuator, with bulbs
up to chassis no. 1K-9-899 999		1LE 247 013-081	1	
		8GH 007 157-121	1	Spare Parts: 1x12V55W (H7) Long Life
		8GH 007 157-121	1	1x12V55W (H7)
		8GA 002 073-121	1	1x12V21W (P21W)
		8GP 003 594-121	1	1x12V5W (W5W)
Golf Plus (5M1, 521) up to chassis no. 1K-9-899 999	01/05->02/09	1LE 247 013-851	1	Upgrade headlight set (black), with bulbs
		8GH 007 157-201	1	Spare Parts: 2x12V55W (H7) Long Life
		8GH 007 157-121	1	2x12V55W (H7)
		8GP 003 594-121	1	2x12V21W (PY21W) Silver Vision
			1	2x12V5W (W5W)
Golf Plus (5M1, 521)	01/05->	5DV 009 000-001	1	Ballast unit
				
Golf Plus (5M1, 521) up to chassis no. 1K-9-899 999	01/05->02/09	1N0 271 289-031	1	FF®-HB4 fog light, left, with bulb
		1N0 271 289-041	1	FF®-HB4 fog light, right, with bulb
		8GH 005 636-121	1	Spare Parts: 1x12V51W (HB4)









Manufacturer Model	Model year	Part no.	Pk.	Note
Volkswagen				
Golf Plus (5M1, 521)		2ZR 964 962-031	1	Reversing light, left, with bulb
Golf Plus (5M1, 521)	01/05->02/09	2NE 964 962-041	1	Rear fog light, right, with bulb
up to chassis no. 1K-9-899 999		8GA 002 073-121	1	Spare Parts: 1x12V21W (P21W)
				
Golf Plus (5M1, 521)	01/05->	2DA 010 415-001	1	Upgrade safety brake light (black)
				
Jetta I (17)		9EL 123 323-011	1	Body/lens for indicator light, left
Jetta I	08/78->02/84	9EL 123 324-011	1	Body/lens for indicator light, right
		8GA 002 073-121	1	Accessories: 1x12V21W (P21W)
				
Jetta II (19E, 1G2)		1NL 006 315-051	1	DE@-H3 fog light, left, with bulb
Jetta II	09/89->10/91	1NL 006 315-061	1	DE@-H3 fog light, right, with bulb
		8GH 002 090-133	1	Spare Parts: 1x12V55W (H3)
				
Jetta II	01/84->08/89	2BA 002 939-171	1	Indicator light (amber)
		9EL 116 771-031	2	Spare Parts: Lens
		8GA 002 073-121	1	Accessories: 1x12V21W (P21W)
				
Jetta II	09/89->10/91	9EL 141 701-001	2	Body/lens for indicator light (amber), left
		9EL 141 702-001	2	Body/lens for indicator light (amber), right
		8GA 002 073-121	1	Accessories: 1x12V21W (P21W)
				
Jetta II	09/89->10/91	2BA 006 728-801	1	Indicator light set (white), with bulbs
		8GA 002 073-121	1	Spare Parts: 2x12V21W (P21W)
				



Manufacturer Model	Model year	Part no.	Pk.	Note
Volkswagen				
Jetta II (19E, 1G2) Jetta II	01/84->10/91	 2BM 003 647-801 2BM 003 647-021 8GP 003 594-121	1 1 1	Auxiliary indicator light set (amber), with bulbs Spare Parts: Auxiliary indicator light (amber) 2x12V5W (W5W)
Jetta II	01/84->10/91	 Design 2BM 006 759-001 8GP 003 594-121	5 1	Auxiliary indicator light (grey), with bulb Spare Parts: 1x12V5W (W5W)
Jetta III (1K2) Jetta III (1K2)	08/05->	 1LG 247 007-191 1LG 247 007-201 8GH 007 157-121 8GA 006 841-121 8GP 003 594-121	1 1 1 1 1	FF@-H7 headlight, left, with indicator light, with electric headlight levelling actuator, with bulbs FF@-H7 headlight, right, with indicator light, with electric headlight levelling actuator, with bulbs Spare Parts: 2x12V55W (H7) 1x12V21W (PY21W) 1x12V5W (W5W)
Jetta III (1K2)	08/05->	 Design 1LL 009 476-031 1LL 009 476-041 8GH 007 157-121 8GA 006 841-121 8GP 003 594-121	1 1 1 1 1	Upgrade headlight, left, with patterned lens, with bulbs Upgrade headlight, right, with patterned lens, with bulbs Note: For registered design reasons, the headlight may only be used to replace lenticular-shaped Jetta III headlights. Spare Parts: 2x12V55W (H7) 1x12V21W (PY21W) 1x12V5W (W5W)
Jetta III (1K2)	08/05->	 1N0 271 295-031 1N0 271 295-041 8GH 005 636-121	1 1 1	FF@-HB4 fog light, left, with bulb FF@-HB4 fog light, right, with bulb Spare Parts: 1x12V51W (HB4)
Lupo (6X1, 6E1) Lupo (6X1, 6E1)	09/98->12/03	 6NM 007 878-041	1	Headlight levelling actuator (for xenon headlight)







Manufacturer Model	Model year	Part no.	Pk.	Note
Volkswagen				
Lupo (6X1, 6E1) Lupo (6X1, 6E1) (-) 1.2 TDI 3L	09/98->07/05	1N0 270 204-051 1N0 270 204-061 8GH 002 090-133	1 1 1	FF®-H3 fog light, left, with bulb FF®-H3 fog light, right, with bulb Spare Parts: 1x12V55W (H3)
				
New Beetle (9C1, 1C1, 1Y7) New Beetle from chassis no. 9C-1-600 001, 1C-1-400 001 (-) Sport Edition New Beetle Convertible	01/98->06/05 01/03->06/05	1N0 010 846-011 1N0 010 846-021 8GH 002 089-133	1 1 1	FF®-H1 fog light, left, with bulb FF®-H1 fog light, right, with bulb Spare Parts: 1x12V55W (H1)
				
Passat (3A2, 3A5, 35l) Passat (3A2, 3A5, 35l)	02/88->08/93	1LH 005 454-311 1LH 005 454-321 6NM 007 282-211 8GJ 002 525-131 8GP 002 067-121	1 1 1 1 1	H4 headlight, left, for vehicles with or without headlight leveller H4 headlight, right, for vehicles with or without headlight leveller Accessories: Headlight levelling actuator Spare Parts: 1x12V60/55W (H4) 1x12V4W (T4W)
				
Passat (3A2, 3A5, 35l)	08/91->08/93	6NM 007 282-211	1	Headlight levelling actuator
				
Passat (3A2, 3A5, 35l)	02/88->08/93	1NL 005 566-051 1NL 005 566-061 8GH 002 090-133	1 1 1	DE®-H3 fog light (white), left DE®-H3 fog light (white), right Accessories: 1x12V55W (H3)
				
Passat (3A2, 3A5, 35l) CL	02/88->08/93	9EL 133 713-011 9EL 133 714-011 8GA 002 073-121	1 1 1	Body/lens for indicator light (amber), left Body/lens for indicator light (amber), right Accessories: 1x12V21W (P21W)
				









Manufacturer Model	Model year	Part no.	Pk.	Note
Volkswagen				
Passat (3A2, 3A5, 35l) Passat (3A2, 3A5, 35l) GL, GT	02/88->08/93	9EL 133 719-011 9EL 133 720-011 8GA 002 073-121	1 1 1	Body/lens for indicator light (white), left Body/lens for indicator light (white), right Accessories: 1x12V21W (P21W)
				
Passat (3A2, 3A5, 35l)	09/93->05/97	1LH 006 840-271 1LH 006 840-281 6NM 007 282-211 8GH 002 089-133 8GP 003 594-121	1 1 1 1 1	FF®-H1 headlight, left, for vehicles with or without headlight leveller FF®-H1 headlight, right, for vehicles with or without headlight leveller Accessories: Headlight levelling actuator Spare Parts: 2x12V55W (H1) 1x12V5W (W5W)
				
Passat (3A2, 3A5, 35l)	09/93->05/97	6NM 007 282-211	1	Headlight levelling actuator
				
Passat (3A2, 3A5, 35l)	09/93->05/97	9HB 006 948-031 9HB 006 948-041	1 1	Dummy, left Dummy, right (next to headlight)
				
Passat (3A2, 3A5, 35l)	09/93->05/97	1NA 006 790-811 1NA 006 790-071 1NA 006 790-081 8XU 006 945-031 8XU 006 945-041 6EH 004 406-032 8GH 002 089-133	1 1 1 1 1 1 1	FF®-H1 fog light set with bulbs Spare Parts: FF®-H1 fog light, left FF®-H1 fog light, right Cover, left Cover, right On/off switch with bulb 2x12V55W (H1)
				
Passat (3A2, 3A5, 35l)	09/93->05/97	9EL 142 459-011 9EL 142 460-011 8GA 006 841-121	1 1 1	Body/lens for indicator light (white), left Body/lens for indicator light (white), right Accessories: 1x12V21W (PY21W)
				
Passat (3A2, 3A5, 35l)	09/93->05/97	8XU 006 946-031 8XU 006 946-041	1 1	Large cover (silver), left Large cover (silver), right (next to indicator light)
				
Passat (3A2, 3A5, 35l)	09/93->05/97	8XU 006 945-031 8XU 006 945-041	1 1	Small cover (silver), left Small cover (silver), right (between indicator and fog light)
				



Manufacturer Model	Model year	Part no.	Pk.	Note
Volkswagen				
Passat (3A2, 3A5, 35I) Passat (3A2, 3A5, 35I)	09/93->05/97	9EL 147 073-001 8GP 003 594-121	2 1	Body/lens for auxiliary indicator light (amber) Accessories: 1x12V5W (W5W)
				
Passat (3A2, 3A5, 35I)	09/93->05/97	9EL 147 073-801 8GP 003 594-121	1 1	Body/lens set for auxiliary indicator light (grey) Accessories: 2x12V5W (W5W)
				
Passat (3A2, 3A5, 35I) (-) Estate	09/93->09/96	9EL 141 889-031 9EL 141 890-031 8GA 002 071-121 8GA 002 073-121	1 1 1 1	Body/lens for combination rearlight, left, outer part (amber/red) Body/lens for combination rearlight, right, outer part (amber/red) Accessories: 1x12V5W (R5W) 2x12V21W (P21W)
				
Passat (3A2, 3A5, 35I) Biker, Classic Line, Highland (-) Estate	09/93->09/96	9EL 141 889-041 9EL 141 890-041 8GA 002 071-121 8GA 002 073-121	1 1 1 1	Body/lens for combination rearlight, left, outer part (grey/red) Body/lens for combination rearlight, right, outer part (grey/red) Accessories: 1x12V5W (R5W) 2x12V21W (P21W)
				
Passat (3A2, 3A5, 35I) (-) Estate	09/93->09/96	9EL 141 907-071 9EL 141 908-071 8GA 002 073-121	1 1 1	Body/lens for combination rearlight, left, inner part (amber/red), with rear fog and reverse light Body/lens for combination rearlight, right, inner part (amber/red), with rear fog and reverse light Accessories: 2x12V21W (P21W)
				
Passat (3B2, 3B5) Passat (3B2, 3B5) standard	08/96->11/00	1LF 007 620-071 1LF 007 620-081 6NM 007 282-211 8GH 007 157-121 8GH 002 089-133 8GP 003 594-121	1 1 1 1 1 1	FF®-H7/H1 headlight, left, without fog light, with 5W bulb for side light FF®-H7/H1 headlight, right, without fog light, with 5W bulb for side light Accessories: Headlight levelling actuator Spare Parts: 1x12V55W (H7) 1x12V55W (H1) 1x12V5W (W5W)
				







Manufacturer Model	Model year	Part no.	Pk.	Note
Volkswagen				
Passat (3B2, 3B5) Passat (3B2, 3B5) Special equipment	08/96->11/00	 1LF 007 520-071 1LF 007 520-081 6NM 007 282-211 8GH 007 157-121 8GJ 002 525-131 8GP 003 594-121	1 1 1 1 1 1 1	FF®-H7/H4 headlight, left, with H4 fog light, with pre-fitted 5W bulb for side light FF®-H7/H4 headlight, right, with H4 fog light, with pre-fitted 5W bulb for side light Accessories: Headlight levelling actuator Spare Parts: 1x12V55W (H7) 1x12V60/55W (H4) 1x12V5W (W5W)
Passat (3B2, 3B5)	08/96->11/00	 6NM 007 282-211	1	Headlight levelling actuator (for halogen headlight)
Passat (3B2, 3B5) Chassis no. 3B-V-000 001 -> 3B-Y-500 000	08/96->11/00	 6NM 007 282-631	1	Headlight levelling actuator (for xenon headlight)
Passat (3B2, 3B5)	08/96->11/00	 5DV 007 760-651	1	Ballast unit
Passat (3B2, 3B5) (-) Xenon light	08/96->11/00	 9EL 151 829-011 9EL 151 830-011 8GA 006 841-121	1 1 1	Body/lens for indicator light (white), left Body/lens for indicator light (white), right Accessories: 1x12V21W (PY21W)
Passat (3B2, 3B5)	08/96->11/00	 9EL 156 099-801 8GP 003 594-541	1 1	Body/lens set for auxiliary indicator light (clear), with 2 amber bulbs Spare Parts: 2x12V5W (WY5W)







Manufacturer Model	Model year	Part no.	Pk.	Note
Volkswagen				
Passat (3B3, 3B6) Passat (3B3, 3B6)	11/00->08/05	 1LL 008 350-031 1LL 008 350-041 6NM 007 878-041 8GH 007 157-201 8GA 006 841-121 8GP 003 594-121	1 1 1 1 1 1	FF®-H7 headlight, left, with indicator light, with headlight levelling actuator, with bulbs FF®-H7 headlight, right, with indicator light, with headlight levelling actuator, with bulbs Spare Parts: Headlight levelling actuator 2x12V55W (H7) Long Life 1x12V21W (PY21W) 1x12V5W (W5W)
Passat (3B3, 3B6)	11/00->08/05	 6NM 007 878-041	1	Headlight levelling actuator
Passat (3B3, 3B6)	11/00->08/05	 1NL 009 034-011 1NL 009 034-021 8GH 002 090-133	1 1 1	DE®-H3 fog light, left, with bulb DE®-H3 fog light, right, with bulb Spare Parts: 1x12V55W (H3)
Passat (3C2, 3C5) Passat (3C2, 3C5)	03/05->	 1LL 247 014-031 1LL 247 014-041 8GH 007 157-201 8GP 003 594-121	1 1 1 1	DE®-H7/FF®-H7 headlight, left, with electric headlight levelling actuator, with bulbs DE®-H7/FF®-H7 headlight, right, with electric headlight levelling actuator, with bulbs Spare Parts: 2x12V55W (H7) Long Life 1x12V5W (W5W)
Passat (3C2, 3C5)	03/05->	 1LL 247 014-841 8GH 007 157-121 8GP 003 594-121	1 1 1	Upgrade headlight set with black design, with bulbs Spare Parts: 4x12V55W (H7) 2x12V5W (W5W)
Passat (3C2, 3C5)	03/05->	 1N0 271 296-031 1N0 271 296-041 8GH 005 636-121	1 1 1	FF®-HB4 fog light, left, with bulb FF®-HB4 fog light, right, with bulb Spare Parts: 1x12V51W (HB4)



Manufacturer Model	Model year	Part no.	Pk.	Note
Volkswagen				
Passat (3C2, 3C5) Passat (3C2, 3C5) Trendline, Blue Motion, Individual Chrom	03/05->	2BA 010 118-011 2BA 010 118-021 8GA 002 073-121	1 1 1	Indicator light (amber), left, with bulb Indicator light (amber), right, with bulb Spare Parts: 1x12V21W (P21W)
				
Passat (3C2, 3C5) Trendline, Blue Motion, Individual Chrom Special equipment Comfortline, Sportline, Highline standard	03/05->	2BA 010 118-031 2BA 010 118-041 8GA 006 841-121	1 1 1	Indicator light (white), left, with bulb Indicator light (white), right, with bulb Spare Parts: 1x12V21W (PY21W)
				
Passat (3C2, 3C5)	03/05->	2BA 010 103-801 8GH 008 417-001	1 1	Indicator light set (black) Accessories: 2x12V21W (H21W)
 Design				
Passat Estate (3C5) (-) R-Line, R36 4-motion	06/05->	2DA 010 415-001	1	Upgrade safety brake light (black)
 Design				
Polo II (86C, 80) Polo II (86C, 80)	10/90->09/94	1NL 006 280-051 1NL 006 280-061 8GH 002 090-133	1 1 1	DE@-H3 fog light, left, with bulb DE@-H3 fog light, right, with bulb Spare Parts: 1x12V55W (H3)
				
Polo II (86C, 80)	10/81->09/90	2BA 002 939-171 9EL 116 771-031 8GA 002 073-121	1 2 1	Indicator light (amber) Spare Parts: Lens Accessories: 1x12V21W (P21W)
				
Polo II (86C, 80) all models with auxiliary indicators as standard feature	10/81->08/91	2BM 003 647-021 8GP 003 594-121	1 1	Auxiliary indicator light (amber) Accessories: 1x12V5W (W5W)
				





Manufacturer Model	Model year	Part no.	Pk.	Note
Volkswagen				
Polo II (86C, 80) Polo II (86C, 80)	09/91->09/94	 2BM 003 647-801 2BM 003 647-021 8GP 003 594-121	1 1 1	Auxiliary indicator light set (amber), with bulbs Spare Parts: Auxiliary indicator light (amber) 2x12V5W (W5W)
Polo II (86C, 80)	09/91->09/94	 2BM 006 759-001 8GP 003 594-121	5 1	Auxiliary indicator light (grey), with bulb Spare Parts: 1x12V5W (W5W)
Polo II (86C, 80) Sedan	01/85->07/88	 9EL 125 910-041 8GD 002 078-121 8GA 002 073-121 8GM 002 092-121	1 1 1 1	Body/lens for combination rearlight, right, with rear fog and reverse light Accessories: 1x12V21/5W (P21/5W) 3x12V21W (P21W) 1x12V5W (C5W)
Polo II (86C, 80) Hatchback, Coupé	10/81->09/90	 2KA 002 445-171 8GP 002 067-121	1 1	Licence plate light Accessories: 1x12V4W (T4W)
Polo II (86C, 80)	10/81->07/85	 2JA 002 931-031 8GA 002 071-131	5 1	Interior light Accessories: 1x12V10W (R10W)
Polo III (6N1) Polo III (6N1) (-) Classic, Estate	10/94->10/99	 1LF 962 489-151 1LF 962 489-161 1LF 962 489-171 1LF 962 489-181 8GJ 002 525-131 8GP 003 594-121	1 1 1 1 1 1	H4 headlight, left, with electric headlight leveller, with 5W bulb for side light H4 headlight, right, with electric headlight leveller, with 5W bulb for side light H4 headlight, left, without electric headlight leveller, with 5W bulb for side light H4 headlight, right, without electric headlight leveller, with 5W bulb for side light Spare Parts: 1x12V60/55W (H4) 1x12V5W (W5W)
Polo III (6N1) all models with small bumper, except Classic and Estate	10/94->10/99	 1NA 962 530-011 1NA 962 530-021 8GH 002 090-133	1 1 1	FF®-H3 fog light, left, with bulb FF®-H3 fog light, right, with bulb Spare Parts: 1x12V55W (H3)







Manufacturer Model	Model year	Part no.	Pk.	Note
Volkswagen				
Polo III (6N1)		1NA 962 490-011	1	FF®-H3 fog light, left, with bulb
Polo III (6N1)	10/94->10/99	1NA 962 490-021	1	FF®-H3 fog light, right, with bulb
all models with large bumper, except Classic and Estate		8GH 002 090-133	1	Spare Parts: 1x12V55W (H3)
				
Polo III (6N1) Basic	10/94->10/99	9EL 962 839-031	1	Body/lens for indicator light (amber), left
(-) Classic, Estate		9EL 962 840-031	1	Body/lens for indicator light (amber), right
		8GA 002 073-121	1	Accessories: 1x12V21W (P21W)
				
Polo III (6N1) Basic	10/94->10/99	2BA 962 625-821	1	Indicator light set (white), with bulbs
(-) Classic, Estate		9EL 962 839-021	1	Spare Parts: Body/lens (white), left
		9EL 962 840-021	1	Body/lens (white), right
		8GA 006 841-121	1	2x12V21W (PY21W)
				
				
Polo III (6N1) Basic with special equipment Styling	10/94->10/99	9EL 962 839-021	1	Body/lens for indicator light (white), left
except Classic and Estate		9EL 962 840-021	1	Body/lens for indicator light (white), right
		8GA 006 841-121	1	Accessories: 1x12V21W (PY21W)
				
Polo III (6N1)	10/94->10/99	9EL 147 073-001	2	Body/lens for auxiliary indicator light (amber)
		8GP 003 594-121	1	Accessories: 1x12V5W (W5W)
				
Polo III (6N1)	10/94->10/99	9EL 147 073-801	1	Body/lens set for auxiliary indicator light (grey)
		8GP 003 594-121	1	Accessories: 2x12V5W (W5W)
				
				



Manufacturer Model	Model year	Part no.	Pk.	Note
Volkswagen				
Polo III (6N1) Polo III (6N1) Basic (-) Classic, Estate	10/94->10/99	 9EL 962 541-041 9EL 962 542-051 8GA 002 071-121 8GA 002 073-121	1 1 1 1	Body/lens for combination rearlight (amber/red/white), left, with reverse light Body/lens for combination rearlight (amber/red), right, with rear fog light Spare Parts: 1x12V5W (R5W) 3x12V21W (P21W)
Polo III (6N1) Basic with special equipment Styling (-) Classic, Estate	10/94->10/99	 9EL 962 542-071 8GA 002 071-121 8GA 002 073-121	1 1 1	Body/lens for combination rearlight (grey/red with black trim stripes), right, with rear fog light Spare Parts: 1x12V5W (R5W) 3x12V21W (P21W)
Polo III (6N2) Polo III (6N2) (-) GTI, Classic, Estate	10/99->10/01	 1LF 963 709-071 1LF 963 709-081 6NM 007 878-041 8GH 007 157-121 8GH 002 089-133 8GP 003 594-121	1 1 1 1 1 1	H1/H7 headlight, left, for vehicles with or without headlight leveller H1/H7 headlight, right, for vehicles with or without headlight leveller Accessories: Headlight levelling actuator Spare Parts: 1x12V55W (H7) 1x12V55W (H1) 1x12V5W (W5W)
Polo III (6N2) chassis no. 6N-Y-500 001 -> 6N-2-010 000	10/99->10/01		1	Headlight levelling actuator
Polo III (6N2) (-) GTI, Classic, Estate	10/99->10/01	 1NA 963 981-031 1NA 963 981-041 8GH 007 157-121	1 1 1	FF@-H7 fog light, left, with bulb FF@-H7 fog light, right, with bulb Spare Parts: 1x12V55W (H7)



Manufacturer Model	Model year	Part no.	Pk.	Note
Volkswagen				
Polo III (6N2) Polo III (6N2) (-) Classic, Estate	10/99->10/01	9EL 964 005-021 9EL 964 006-021 8GA 006 841-121	1 1 1	Body/lens for indicator light (white), left Body/lens for indicator light (white), right Accessories: 1x12V21W (PY21W)
				
Polo III (6N2)	10/99->10/01	9EL 156 099-801 8GP 003 594-541	1 1	Body/lens set for auxiliary indicator light (clear), with 2 amber bulbs Spare Parts: 2x12V5W (WY5W)
				
Polo III (6N2) (-) Classic, Estate	10/99->10/01	9EL 964 116-121 8GA 002 071-121 8GA 002 073-121	1 1 1	Body/lens for combination rearlight (red), right, with rear fog light Spare Parts: 1x12V5W (R5W) 3x12V21W (P21W)
				
Polo IV (9N_) Polo IV (9N_) Chassis no. 9N-2-000 001 -> 9N-5-150 000 Polo Sedan	10/01->04/05 04->07	1N0 270 255-051 1N0 270 255-061 8GH 002 090-133	1 1 1	FF®-H3 fog light, left, with bulb FF®-H3 fog light, right, with bulb Spare Parts: 1x12V55W (H3)
				
Polo IV (9N_)	10/01->04/05	9EL 156 099-801 8GP 003 594-541	1 1	Body/lens set for auxiliary indicator light (clear), with 2 amber bulbs Spare Parts: 2x12V5W (WY5W)
				









Manufacturer Model	Model year	Part no.	Pk.	Note
Volkswagen				
Polo IV (9N2) Polo IV (9N2) (-) GTI	05/05->06/09	 1LE 247 019-191 1LE 247 019-201 8GH 007 157-121 8GH 002 089-133 8GA 006 841-121 8GP 003 594-121	1 1 1 1 1	FF®-H7/H1 headlight, left, with indicator light, with electric headlight levelling actuator, with bulbs FF®-H7/H1 headlight, right, with indicator light, with electric headlight levelling actuator, with bulbs Spare Parts: 1x12V55W (H7) 1x12V55W (H1) 1x12V21W (PY21W) 1x12V5W (W5W)
Polo IV (9N2)	05/05->06/09	 1N0 271 247-051 1N0 271 247-061 8GH 005 636-121	1 1 1	FF®-HB4 fog light, left, with bulb FF®-HB4 fog light, right, with bulb Spare Parts: 1x12V51W (HB4)
Polo V (6R_) Polo V (6R_) from chassis no. 6R-A-000 001 for PR no. 8BK (-) Trendline, GTI	06/09->	 1LE 247 051-031 1LE 247 051-041 8GH 007 157-201 8GH 007 157-121 8GA 006 841-121 8GP 003 594-121	1 1 1 1 1 1	H7 headlight, left, with indicator light, with electric headlight levelling actuator, with bulbs H7 headlight, right, with indicator light, with electric headlight levelling actuator, with bulbs Spare Parts: 1x12V55W (H7) Long Life 1x12V55W (H7) 1x12V21W (PY21W) 1x12V5W (W5W)
Polo V (6R_) from chassis no. 6R-A-000 001	06/09->	 2VA 354 669-031 2VA 354 669-041 8GP 003 594-121 8GA 006 841-121 8GA 002 073-121 8GH 008 417-001	1 1 1 1 1 1	Combination rearlight, left, with reverse light, with bulbs Combination rearlight, right, with rear fog light, with bulbs Manufacturer: Visteon Spare Parts: 1x12V5W (W5W) 1x12V21W (PY21W) 2x12V21W (P21W) 1x12V21W (H21W)
Scirocco (53B) Scirocco (53B) GT, GTI	06/81->07/82	 1LB 003 177-511 1KB 003 177-597 9GH 116 966-011 8GJ 002 525-131 8GH 002 089-133 8GP 002 067-121	1 36 10 1 1 1	H4/H1 headlight, only spare parts available Spare Parts: H4 dipped beam headlight H1 spotlight unit Cap 1x12V60/55W (H4) 1x12V55W (H1) 1x12V4W (T4W)



Manufacturer Model	Model year	Part no.	Pk.	Note
Volkswagen				
Scirocco (137)		1N0 271 295-031	1	FF®-HB4 fog light, left, with bulb
Scirocco (137)	09/08->	1N0 271 295-041	1	FF®-HB4 fog light, right, with bulb
		8GH 005 636-121	1	Spare Parts: 1x12V51W (HB4)
Sharan (7M8, 7M9, 7M6)		9EL 147 073-001	2	Body/lens for auxiliary indicator light (amber)
Sharan (7M8, 7M9, 7M6)	09/95->04/00	8GP 003 594-121	1	Accessories: 1x12V5W (W5W)
				
Sharan (7M8, 7M9, 7M6)		9EL 147 073-801	1	Body/lens set for auxiliary indicator light (grey)
Sharan (7M8, 7M9, 7M6)	09/95->04/00	8GP 003 594-121	1	Accessories: 2x12V5W (W5W)
				
Sharan (7M8, 7M9, 7M6)		9EL 156 099-801	1	Body/lens set for auxiliary indicator light (clear), with 2 amber bulbs
Sharan (7M8, 7M9, 7M6)	04/00->	8GP 003 594-541	1	Spare Parts: 2x12V5W (WY5W)
				
Sharan (7M8, 7M9, 7M6)		9EL 962 585-041	1	Body/lens for combination rearlight, left, outer part (amber/red)
(-) Trendline	09/95->04/00	9EL 962 586-041	1	Body/lens for combination rearlight, right, outer part (amber/red)
		8GA 002 071-121	1	Accessories: 1x12V5W (R5W)
		8GD 002 078-121	1	1x12V21/5W (P21/5W)
		8GA 002 073-121	1	1x12V21W (P21W)
Sharan (7M8, 7M9, 7M6)		9EL 964 501-011	1	Body/lens for combination rearlight, left, outer part (red/pink)
(-) Trendline	04/00->10/03	9EL 964 502-011	1	Body/lens for combination rearlight, right, outer part (red/pink)
		8GA 002 071-121	1	Accessories: 1x12V5W (R5W)
		8GA 002 073-121	1	2x12V21W (P21W)



Manufacturer Model	Model year	Part no.	Pk.	Note
Volkswagen				
Sharan (7M8, 7M9, 7M6) Sharan (7M8, 7M9, 7M6) (-) Trendline	04/00->10/03	 9EL 964 541-021 9EL 964 542-021 8GA 002 073-121	1 1 1	Body/lens for combination rearlight, left, inner part (grey/red), with rear fog and reverse light Body/lens for combination rearlight, right, inner part (grey/red), with rear fog and reverse light Accessories: 4x12V21W (P21W)
Sharan (7M8, 7M9, 7M6)	04/00->10/03	 8XU 964 435-021	1	Cover (black/red) for retaining the licence plate
Sharan (7M8, 7M9, 7M6)	11/03->	 2VA 964 957-011 2VA 964 957-021 8GD 002 078-121 8GA 002 073-121	1 1 1 1	Combination rearlight, left, outer part (red/white), with bulbs Combination rearlight, right, outer part (red/white), with bulbs Spare Parts: 1x12V21/5W (P21/5W) 1x12V21W (P21W)
Sharan (7M8, 7M9, 7M6)	11/03->	 8XU 964 981-001	1	Cover (base-coated) for retaining the licence plate
Tiguan (5N_) Tiguan (5N_)	09/07->	 1LD 247 038-231 1LD 247 038-241 8GH 007 157-121 8GH 007 157-201 8GA 006 841-121 8GP 003 594-121	1 1 1 1 1 1	H7 headlight, left, with indicator light, with electric headlight levelling actuator, with bulbs H7 headlight, right, with indicator light, with electric headlight levelling actuator, with bulbs Spare Parts: 1x12V55W (H7) 1x12V55W (H7) Long Life 1x12V21W (PY21W) 1x12V5W (W5W)
Tiguan (5N_)	09/07->	 1N0 271 289-031 1N0 271 289-041 8GH 005 636-121	1 1 1	FF@-HB4 fog light, left, with bulb FF@-HB4 fog light, right, with bulb Spare Parts: 1x12V51W (HB4)



Manufacturer Model	Model year	Part no.	Pk.	Note
Volkswagen				
Tiguan (5N_) Tiguan (5N_)	09/07->	2SD 009 691-091 2SD 009 691-101 8GA 002 073-271 8GP 009 021-002	1 1 1 1	Combination rearlight, left, outer part, with bulbs Combination rearlight, right, outer part, with bulbs Spare Parts: 2x12V21W (P21W) Long Life 1x12V21W (WY21W)
				
Tiguan (5N_)	09/07->	2DA 010 415-001	1	Upgrade safety brake light (black)
				
Touareg (7LA, 7L6, 7L7) Touareg (7LA, 7L6, 7L7)	12/06->05/10	5DV 009 000-001	1	Ballast unit
				
Touareg (7LA, 7L6, 7L7) Chassis no. 7LA*** (-) Individual	10/02->11/06	1N0 010 844-011 1N0 010 844-021 8GH 008 358-121	1 1 1	FF®-H11 fog light, left, with bulb FF®-H11 fog light, right, with bulb Spare Parts: 1x12V55W (H11)
				
Touareg (7LA, 7L6, 7L7) Individual	10/02->05/10	1N0 271 247-051 1N0 271 247-061 8GH 005 636-121	1 1 1	FF®-HB4 fog light, left, with bulb FF®-HB4 fog light, right, with bulb Spare Parts: 1x12V51W (HB4)
				









Manufacturer Model	Model year	Part no.	Pk.	Note
Volkswagen				
Touran (1T1, 1T2, 1T3) Touran (1T1, 1T2, 1T3) from chassis no. 1T-5-000 001	02/03->10/06	1LL 010 203-031 1LL 010 203-041 8GH 007 157-121 8GH 002 089-133 8GA 006 841-121 8GP 003 594-121	1 1	H1/H7 headlight, left, with indicator light, with electric headlight levelling actuator H1/H7 headlight, right, with indicator light, with electric headlight levelling actuator Manufacturer: Visteon Spare Parts: 1x12V55W (H7) 1x12V55W (H1) 1x12V21W (PY21W) 1x12V5W (W5W)
				
Touran (1T1, 1T2, 1T3) up to chassis no. 1T-5-083 127	02/03->10/04	1N0 270 596-051 1N0 270 596-061 8GH 008 358-121	1 1	DE@-H11 fog light, left, with bulb DE@-H11 fog light, right, with bulb Spare Parts: 1x12V55W (H11)
				
Touran (1T1, 1T2, 1T3) from chassis no. 1T-5-083 128	11/04->04/10	1N0 271 289-031 1N0 271 289-041 8GH 005 636-121	1 1	FF@-HB4 fog light, left, with bulb FF@-HB4 fog light, right, with bulb Spare Parts: 1x12V51W (HB4)
				
Touran (1T1, 1T2, 1T3)	02/03->10/06	2VP 008 759-051 2VP 008 759-061 8GA 002 071-121 8GA 002 073-121 8GA 006 841-121	1 1	Combination rearlight, left, with rear fog and reverse light, with bulbs Combination rearlight, right, with rear fog and reverse light, with bulbs Spare Parts: 1x12V5W (R5W) 3x12V21W (P21W) 1x12V21W (PY21W)
				
Touran (1T1, 1T2, 1T3) (-) CrossTouran	11/06->04/10	2SK 009 477-051 2SK 009 477-061 8GA 002 071-121 8GA 002 073-121 8GA 006 841-121	1 1	Combination rearlight, left, with rear fog and reverse light, with bulbs Combination rearlight, right, with rear fog and reverse light, with bulbs Spare Parts: 1x12V5W (R5W) 3x12V21W (P21W) 1x12V21W (PY21W)
				



Manufacturer Model	Model year	Part no.	Pk.	Note
Volkswagen				
Touran (1T1, 1T2, 1T3) Touran (1T1, 1T2, 1T3)	02/03->04/10	9EL 008 759-811 8GA 002 071-131 8GA 002 073-121	1 1 1	Design combination rearlight set (grey/silver/red), with 2 21W indicator light bulbs (Silver Vision) without bulb holder Accessories: 2x12V10W (R10W) 8x12V21W (P21W)
				
				Design
Vento (1H2) Vento (1H2)	11/91->09/98	6NM 007 282-211	1	Headlight levelling actuator
				
Vento (1H2)	11/91->09/98	1NL 007 220-031 1NL 007 220-041 8GH 002 090-133	1 1 1	DE@-H3 fog light, left DE@-H3 fog light, right Accessories: 1x12V55W (H3)
				
Vento (1H2) CL, GL	11/91->09/98	9EL 144 425-001 9EL 144 426-001 8GA 002 073-121	1 1 1	Body/lens for indicator light (amber), left Body/lens for indicator light (amber), right Accessories: 1x12V21W (P21W)
				
Vento (1H2) GT, VR6	11/91->09/98	9EL 144 425-011 9EL 144 426-011 8GA 002 073-121	1 1 1	Body/lens for indicator light (white), left Body/lens for indicator light (white), right Accessories: 1x12V21W (P21W)
				
Vento (1H2)	11/91->09/98	8XU 144 427-001 8XU 144 428-001	2 2	Large cover (silver), left Large cover (silver), right (next to indicator light)
				
Vento (1H2)	11/91->09/98	8XU 144 429-001 8XU 144 430-001	1 1	Small cover (silver), left Small cover (silver), right (between indicator and fog light)
				
Vento (1H2)	11/91->08/95	9EL 144 431-001 8GP 003 594-121	2 1	Body/lens for auxiliary indicator light (amber) Accessories: 1x12V5W (W5W)
				



Manufacturer Model	Model year	Part no.	Pk.	Note
Volkswagen				
Vento (1H2) Vento (1H2)	09/95->09/98	9EL 147 073-001 8GP 003 594-121	2 1	Body/lens for auxiliary indicator light (amber) Accessories: 1x12V5W (W5W)
				
Transporter (T2) Transporter (T2) Bus	08/73->07/79	1L8 003 060-561 9GH 116 966-011 9FF 126 444-001 8GD 002 088-131 8GP 002 067-121 1L8 003 060-691 9GH 116 966-011 9FF 126 444-001 8GJ 002 525-131 8GP 002 067-121	1 10 10 1 1 1 10 10 1 1	Headlight Spare Parts: Cap Bulb socket for side light 1x12V45/40W (R2) 1x12V4W (T4W) H4 headlight Spare Parts: Cap Bulb socket for side light (to be ordered separately) 1x12V60/55W (H4) 1x12V4W (T4W)
				
Transporter (T2) Bus	08/71->07/79	 9EL 113 065-001 8GD 002 078-121 8GA 002 073-121	 1 1 1	Combination rearlight with reverse light, only spare parts available Spare Parts: Lens Accessories: 1x12V21/5W (P21/5W) 2x12V21W (P21W)
				
Transporter (T3) Transporter (T3) Bus, Caravelle	05/79->07/92	 9EL 122 377-011 8GA 002 073-121	 1 1	Indicator light, only spare parts available Spare Parts: Body/lens, left Accessories: 1x12V21W (P21W)
				
Transporter (T3) Bus, Caravelle	05/79->07/92	 9EL 122 149-011 9EL 122 150-011 8GA 002 071-131 8GA 002 073-121	 1 1 1 1	Combination rearlight, with rear fog and reverse light, only spare parts available Spare Parts: Body/lens, left Body/lens, right Accessories: 1x12V10W (R10W) 4x12V21W (P21W)
				
Transporter (T3) Bus, Caravelle	05/79->07/92	2JA 002 931-031 8GM 002 091-131	5 1	Interior light Accessories: 1x12V10W (K)
				



Manufacturer Model	Model year	Part no.	Pk.	Note
Volkswagen				
Transporter (T4) Transporter (T4) California, Caravelle, Multivan PR no. AC0 with short front-end	09/90->04/03	1LJ 006 051-191	1	H4 headlight, left
		1LJ 006 051-201	1	H4 headlight, right
		6NM 007 282-211	1	Accessories: Headlight levelling actuator
		8GJ 002 525-131	1	Spare Parts: 1x12V60/55W (H4)
		8GP 002 067-121	1	1x12V4W (T4W)
				
Transporter (T4) California, Caravelle, Multivan Chassis no. 70-T-200 001 -> 70-1-048 000	01/96->01	6NM 007 282-211	1	Headlight levelling actuator
				
Transporter (T4) California, Caravelle, Multivan up to 1.65t (short wheelbase)	09/90->12/95	1NL 006 250-051	1	DE®-H3 fog light, left
		1NL 006 250-061	1	DE®-H3 fog light, right
		8GH 002 090-133	1	Accessories: 1x12V55W (H3)
				
Transporter (T4) California, Caravelle, Multivan	01/96->04/03	1NB 008 122-011	1	FF®-H3 fog light, left
		1NB 008 122-021	1	FF®-H3 fog light, right
		8GH 002 090-133	1	Accessories: 1x12V55W (H3)
				
Transporter (T4) California, Caravelle, Multivan PR no. AC0 with short front-end	09/90->04/03	9EL 136 401-011	1	Body/lens for indicator light (amber), left
		9EL 136 402-011	1	Body/lens for indicator light (amber), right
		8GA 002 073-121	1	Accessories: 1x12V21W (P21W)
				







Manufacturer Model	Model year	Part no.	Pk.	Note
Volkswagen				
Transporter (T4) Transporter (T4) California, Caravelle, Multivan	09/90->04/03	9EL 146 371-001 9EL 146 372-001 8GD 002 078-121 8GA 002 073-121	1 1 1 1	Body/lens for combination rearlight (amber/red), left Body/lens for combination rearlight (amber/red), right Accessories: 1x12V21/5W (P21/5W) 2x12V21W (P21W)
				
Transporter (T4) California, Caravelle, Multivan	09/90->04/03	9EL 146 373-001 8GA 002 073-121	1 1	Body/lens for rear fog light Accessories: 1x12V21W (P21W)
				
Multivan (T5) Multivan (T5) up to chassis no. 7H-5-020 000, 7J-5-015 000	04/03->	1N0 270 481-051 1N0 270 481-061 8GH 005 636-121	1 1 1	FF®-HB4 fog light, left, with bulb FF®-HB4 fog light, right, with bulb Spare Parts: 1x12V51W (HB4)
				
Multivan (T5) Chassis no. 7H-5-020 001, -> 7H-A-050 000, 7J-5-015 001 -> 7J-A-010 000	04/03->10/09	1N0 271 247-051 1N0 271 247-061 8GH 005 636-121	1 1 1	FF®-HB4 fog light, left, with bulb FF®-HB4 fog light, right, with bulb Spare Parts: 1x12V51W (HB4)
				
Multivan (T5) Vehicles with tailgate	04/03->10/09	2SK 008 579-091 2SK 008 579-101 8GA 002 073-121 8GD 004 772-121	1 1 1 1	Combination rearlight (amber/red), left, with rear fog and reverse light, with bulbs Combination rearlight (amber/red), right, with rear fog and reverse light, with bulbs Spare Parts: 3x12V21W (P21W) 1x12V21/4W (P21/4W)
				



Volkswagen - Volvo



Manufacturer Model	Model year	Part no.	Pk.	Note
Volkswagen				
Multivan (T5) Multivan (T5) Vehicles with tailgate	04/03->10/09	 2SK 008 579-131 2SK 008 579-141 8GA 002 073-121 8GD 004 772-121	1 1 1 1	Combination rearlight (red/white), left, with rear fog and reverse light, with bulbs Combination rearlight (red/white), right, with rear fog and reverse light, with bulbs Spare Parts: 3x12V21W (P21W) 1x12V21/4W (P21/4W)
Multivan (T5) Vehicles with tailgate	04/03->10/09	 2SK 008 579-151 2SK 008 579-161 8GD 002 078-121 8GA 002 073-121	1 1 1 1	Design combination rearlight (silver/red), left, with rear fog and reverse light, with bulbs Design combination rearlight (silver/red), right, with rear fog and reverse light, with bulbs Spare Parts: 1x12V21/5W (P21/5W) 2x12V21W (P21W) 1x12V21W (P21W) Silver Vision
Multivan (T5) Vehicles with gull-wing doors	04/03->10/09	 2SK 008 579-111 2SK 008 579-121 8GA 002 073-121 8GD 004 772-121	1 1 1 1	Combination rearlight (amber/red), left, with rear fog and reverse light, with bulbs Combination rearlight (amber/red), right, with rear fog and reverse light, with bulbs Spare Parts: 3x12V21W (P21W) 1x12V21/4W (P21/4W)
Volvo				
C70 C70 Coupé C70 Convertible	03/97->09/02 03/98->10/05	 9EL 147 723-071 *) 9EL 147 724-071 *) 8GA 006 841-121	1 1 1	Body/lens for indicator light (white), left Body/lens for indicator light (white), right Accessories: 1x12V21W (PY21W)

*) The products marked are available only in countries of the European Union



Manufacturer Model	Model year	Part no.	Pk.	Note
Volvo				
S40 I (VS) S40 I (VS)	07/95->07/00	 1LG 007 302-191 *) 1LG 007 302-201 *) 6NM 007 282-651 8GJ 002 525-131 8GP 002 067-121	1 1 1 1 1	H4 headlight, left, suitable for headlight leveller H4 headlight, right, suitable for headlight leveller Accessories: Headlight levelling actuator Spare Parts: 1x12V60/55W (H4) 1x12V4W (T4W)
S40 I (VS)	08/00->12/03	 1LG 007 861-451 *) 1LG 007 861-461 *) 6NM 007 878-551 8GH 007 157-121 8GP 002 067-121	1 1 1 1 1	FF@-H7 headlight, left, with chrome-plated cover, with electric headlight levelling actuator FF@-H7 headlight, right, with chrome-plated cover, with electric headlight levelling actuator Spare Parts: Headlight levelling actuator 2x12V55W (H7) 1x12V4W (T4W)
S40 I (VS)	07/95->12/03	 6NM 007 282-651	1	Headlight levelling actuator (for H4 headlight)
S40 I (VS)	07/95->12/03	 6NM 007 878-551	1	Headlight levelling actuator (for H7 and xenon headlight)
S40 I (VS)	07/95->07/00	 2BA 007 924-071 *) 2BA 007 924-081 *) 8GA 006 841-121	1 1 1	Indicator light (white), left, with bulb Indicator light (white), right, with bulb Spare Parts: 1x12V21W (PY21W)
S70 S70	01/97->11/00	 9EL 147 723-071 *) 9EL 147 724-071 *) 8GA 006 841-121	1 1 1	Body/lens for indicator light (white), left Body/lens for indicator light (white), right Accessories: 1x12V21W (PY21W)
S70	01/97->11/00	 9EL 341 325-311 *) 9EL 341 325-321 *) 8GA 002 071-121 8GA 002 073-121	1 1 1 1	Body/lens for combination rearlight, left, outer part Body/lens for combination rearlight, right, outer part Accessories: 1x12V5W (R5W) 2x12V21W (P21W)

*) The products marked are available only in countries of the European Union



Volvo



Manufacturer Model	Model year	Part no.	Pk.	Note
Volvo				
S70 S70	01/97->11/00	 9EL 341 326-311 *) 9EL 341 326-321 *) 8GA 002 071-121 8GA 002 073-121	1 1 1 1	Body/lens for combination rearlight, left, inner part, with rear fog and reverse light Body/lens for combination rearlight, right, inner part, with rear fog and reverse light Accessories: 1x12V5W (R5W) 2x12V21W (P21W)
S80 S80	05/98->12/00	 9EL 149 957-121 *) 9EL 149 958-121 *) 8GA 002 071-121 8GA 002 073-121 8GA 006 841-121 8GD 004 772-121	1 1 1 1 1 1	Body/lens for combination rearlight, left, with rear fog and reverse light Body/lens for combination rearlight, right, with rear fog and reverse light Accessories: 1x12V5W (R5W) 1x12V21W (P21W) 1x12V21W (PY21W) 1x12V21/4W (P21/4W)
V40 (VW) V40 (VW)	07/95->07/00	 1LG 007 302-191 *) 1LG 007 302-201 *) 6NM 007 282-651 8GJ 002 525-131 8GP 002 067-121	1 1 1 1 1	H4 headlight, left, suitable for headlight leveller H4 headlight, right, suitable for headlight leveller Accessories: Headlight levelling actuator Spare Parts: 1x12V60/55W (H4) 1x12V4W (T4W)
V40 (VW)	08/00->06/04	 1LG 007 861-451 *) 1LG 007 861-461 *) 6NM 007 878-551 8GH 007 157-121 8GP 002 067-121	1 1 1 1 1	FF®-H7 headlight, left, with chrome-plated cover, with electric headlight levelling actuator FF®-H7 headlight, right, with chrome-plated cover, with electric headlight levelling actuator Spare Parts: Headlight levelling actuator 2x12V55W (H7) 1x12V4W (T4W)
V40 (VW)	07/95->		1	Headlight levelling actuator (for H4 headlight)
V40 (VW)	07/95->		1	Headlight levelling actuator (for H7 and xenon headlight)

*) The products marked are available only in countries of the European Union





Manufacturer Model	Model year	Part no.	Pk.	Note
Volvo				
V40 (VW) V40 (VW)	07/95->07/00	2BA 007 924-071 *) 2BA 007 924-081 *) 8GA 006 841-121	1 1 1	Indicator light (white), left, with bulb Indicator light (white), right, with bulb Spare Parts: 1x12V21W (PY21W)
				
V70 I Estate V70 I Estate	01/97->11/00	9EL 147 723-071 *) 9EL 147 724-071 *) 8GA 006 841-121	1 1 1	Body/lens for indicator light (white), left Body/lens for indicator light (white), right Accessories: 1x12V21W (PY21W)
				
XC 90 XC 90	10/02->	1N0 010 789-011 1N0 010 789-021 8GH 002 089-133	1 1 1	FF®-H1 fog light, left, with bulb FF®-H1 fog light, right, with bulb Spare Parts: 1x12V55W (H1)
				
850 (LS, LW) 850 (LS), 850 Estate (LW)	08/93->10/97	9EL 142 723-011 *) 9EL 142 724-011 *) 8GA 002 073-121	1 1 1	Body/lens for indicator light (white), left Body/lens for indicator light (white), right Accessories: 1x12V21W (P21W)
				
940 (944) 940 (944)	08/90->12/94	9EL 138 601-031 *) 9EL 138 602-031 *) 8GA 002 071-121 8GA 002 073-121	1 1 1 1	Body/lens for combination rearlight, left, outer part Body/lens for combination rearlight, right, outer part Accessories: 1x12V5W (R5W) 2x12V21W (P21W)
				
940 (944)	08/90->12/94	9EL 138 649-031 *) 9EL 138 650-031 *) 8GA 002 071-121 8GA 002 073-121	1 1 1 1	Body/lens for combination rearlight, left, inner part, with rear fog and reverse light Body/lens for combination rearlight, right, inner part, with rear fog and reverse light Accessories: 1x12V5W (R5W) 2x12V21W (P21W)
				

*) The products marked are available only in countries of the European Union



Volvo



Manufacturer Model	Model year	Part no.	Pk.	Note
Volvo				
960 (964) 960 (964)	08/90->07/94	 9EL 138 601-041 *) 9EL 138 602-041 *) 8GA 002 073-121	1 1 1	Body/lens for combination rearlight, left, outer part Body/lens for combination rearlight, right, outer part Accessories: 2x12V21W (P21W)
960 (964)	08/90->07/94	 9EL 138 649-041 *) 9EL 138 650-041 *) 8GA 002 073-121	1 1 1	Body/lens for combination rearlight, left, inner part, with rear fog and reverse light Body/lens for combination rearlight, right, inner part, with rear fog and reverse light Accessories: 2x12V21W (P21W)

*) The products marked are available only in countries of the European Union



Headlights, Signal and Sundry Lights for Light Commercial Vehicles



List of Manufacturers/Page

2.02

Headlights, Signal and Sundry Lights -
Application Chart for Light Commercial Vehicles

2.03 - 2.36



List of Manufacturers/Page



Manufacturer	Model year	Page	Manufacturer	Model year	Page
Citroën			Peugeot		
Berlingo (MF, M_)	11/02->	2.03	Partner Box (5)	11/02->	2.20
Jumper	04/06->	2.03	Renault		
Fiat			Clio II Box (SB0/1/2_)	09/98->	2.20 - 2.21
Ducato (250)	07/06->	2.03	Kangoo Express (FC0/1_)	03/98->01/08	2.21
Punto Van (176L)	04/96->02/00	2.03 - 2.04	Master II	07/98->10/03	2.21
Ford			Master IV	02/10->	2.22
Escort '95 Express (AVL)	01/95->	2.04	Trafic II (JL/EL/FL)	03/01->	2.22
Fiesta Box	01/94->02/96	2.04	Twingo Box (S06_)	03/93->	2.22
Fiesta Box (J5_, J3_, JV_)	02/96->	2.04	19 II Box (S53_)	03/92->12/95	2.22
Fiesta Van	11/01->10/05	2.04	Seat		
Transit (T_)	09/85->09/92	2.05	Inca (6K9)	11/95->06/03	2.22
Transit (E_)	01/91->07/00	2.05	Skoda		
Transit (F_)	01/00->07/06	2.06	Fabia Praktik	04/02->	2.23
Transit	07/06->	2.07	Praktik	03/10->	2.24 - 2.25
Iveco			Vauxhall		
Daily II	05/99->12/06	2.07	Astravan Mk IV (G)	08/98->	2.25
Mercedes-Benz			Astravan Mk V (H)	03/05->01/07	2.26
L 405 D - L 911 (T2/L)	01/68->12/88	2.07 - 2.09	Combo II	09/01->	2.27
Sprinter 901/902/903/904	02/95->05/06	2.09 - 2.11	Corsavan Mk III	09/00->	2.27
Sprinter (906)	06/06->	2.11	Volkswagen		
Vario 512 D - 816 DA	09/96->	2.12	Caddy III (2K_, 2CA, 2CH)	09/10->12/04	2.27 - 2.28
Vito (W 639)	09/10->	2.13	Crafter (2E_/2F_)	04/06->	2.29
207 D - 410 (T1, TN)	05/77->02/96	2.13 - 2.15	LT I	04/75->04/96	2.29 - 2.30
507 D - 814 D (T2/LN1)	04/86->12/94	2.15 - 2.16	LT II	05/96->07/06	2.30
Nissan			Polo Box (86CF)	08/92->08/94	2.30 - 2.31
Primastar (X83)	09/02->07/06	2.16	Polo Box (6NF)	09/94->12/99	2.31 - 2.32
Opel			Transporter (T2)	08/71->07/79	2.32 - 2.33
Astra F Van	10/91->08/94	2.17	Transporter (T3)	05/79->07/92	2.33
Astra G Box	01/99->04/05	2.17	Transporter (T4)	09/90->04/03	2.33 - 2.34
Astra H Box	03/04->01/07	2.17 - 2.18	Transporter (T5)	04/03->	2.35 - 2.36
Combo II	10/01->	2.19			
Corsa C Box	09/00->	2.19			
Kadett E	01/86->07/94	2.19			
Movano B	05/10->	2.19			
Vivaro (J7/E7/F7)	08/01->07/06	2.20			
Peugeot					
Boxer	04/06->	2.20			









Manufacturer Model	Model year	Part no.	Pk.	Note
Citroën				
Berlingo (MF, M_) Berlingo (MF, M_)	11/02->	1LG 010 196-031 1LG 010 196-041 8GJ 002 525-131 8GA 006 841-121 8GP 003 594-121	1 1 1 1 1	H4 headlight, left, with indicator light, with electric headlight levelling actuator H4 headlight, right, with indicator light, with electric headlight levelling actuator Spare Parts: 1x12V60/55W (H4) 1x12V21W (PY21W) 1x12V5W (W5W)
				
Jumper Jumper	04/06->	2PT 010 043-811	1	Daytime running light set LEDayLine®
				
Fiat				
Ducato (250) Ducato (250)	07/06->	2PT 010 043-811	1	Daytime running light set LEDayLine®
				
Punto Van (176L) Punto Van (176L)	04/96->02/00	1LF 006 826-251 1LF 006 826-261 8GH 002 089-133 8GP 003 594-121	1 1 1 1	FF®-H1 headlight, left, with manual headlight leveller, also suitable for vehicles with electric headlight leveller FF®-H1 headlight, right, with manual headlight leveller, also suitable for vehicles with electr. headlight leveller Spare Parts: 2x12V55W (H1) 1x12V5W (W5W)
				
Punto Van (176L)	04/96->02/00	6NM 007 282-661	1	Headlight levelling actuator
				
Punto Van (176L)	04/96->02/00	2BA 006 749-071 2BA 006 749-081 8GA 002 073-121	1 1 1	Indicator light (amber), left Indicator light (amber), right Accessories: 1x12V21W (P21W)
				



Manufacturer Model	Model year	Part no.	Pk.	Note
Fiat				
Punto Van (176L)		2BA 006 749-051	1	Indicator light (white), left
Punto Van (176L)	04/96->02/00	2BA 006 749-061	1	Indicator light (white), right
		8GA 002 073-121	1	Accessories: 1x12V21W (P21W)
Ford				
Escort '95 Express (AVL)		1NE 007 517-051	1	FF®-H3 fog light, left
Escort '95 Express (AVL)	01/95->	1NE 007 517-061	1	FF®-H3 fog light, right
		8GH 002 090-133	1	Accessories: 1x12V55W (H3)
Fiesta Box		2BA 919 370-051	1	Indicator light (white), left, with bulb
Fiesta Box	01/94->02/96	2BA 919 370-061	1	Indicator light (white), right, with bulb
		8GA 006 841-121	1	Spare Parts: 1x12V21W (PY21W)
Fiesta Box (J5_, J3_, JV_)		2VP 354 034-011	1	Combination rearlight, left, with rear fog and reverse light
Fiesta Box (J5_, J3_)	02/96->	2VP 354 034-021	1	Combination rearlight, right, with rear fog and reverse light
Fiesta Box (JV_)	05/98->	8GD 002 078-121	1	Accessories: 1x12V21/5W (P21/5W)
		8GA 002 073-121	1	3x12V21W (P21W)
Fiesta Van		1LF 010 197-031	1	H4 headlight, left, with indicator light, with electric headlight levelling actuator
Fiesta Van	11/01->10/05	1LF 010 197-041	1	H4 headlight, right, with indicator light, with electric headlight levelling actuator
		8GJ 002 525-131	1	Spare Parts: 1x12V60/55W (H4)
		8GA 006 841-121	1	1x12V21W (PY21W)
		8GP 003 594-121	1	1x12V5W (W5W)





Manufacturer Model	Model year	Part no.	Pk.	Note
Ford				
Transit (T_) Transit (T_) Bus, Box	09/85->09/92	 2VP 354 034-011 2VP 354 034-021 8GD 002 078-121 8GA 002 073-121	1 1 1 1	Combination rearlight, left, with rear fog and reverse light Combination rearlight, right, with rear fog and reverse light Accessories: 1x12V21/5W (P21/5W) 3x12V21W (P21W)
Transit (E_) Transit (E_)	08/94->07/00	 1LG 354 023-031 1LG 354 023-041 8GJ 002 525-131 8GP 003 594-121	1 1 1 1	H4 headlight, left, for vehicles with headlight leveller (black body, plastic lens) H4 headlight, right, for vehicles with headlight leveller (black body, plastic lens) Spare Parts: 1x12V60/55W (H4) 1x12V5W (W5W)
Transit (E_)	08/94->07/00	 1LG 354 023-071 1LG 354 023-081 8GJ 002 525-131 8GP 003 594-121	1 1 1 1	H4 headlight, left, for vehicles without headlight leveller (black body, plastic lens) H4 headlight, right, for vehicles without headlight leveller (black body, plastic lens) Spare Parts: 1x12V60/55W (H4) 1x12V5W (W5W)
Transit (E_)	06/94->07/00	 1NE 007 517-051 1NE 007 517-061 8GH 002 090-133	1 1 1	FF®-H3 fog light, left FF®-H3 fog light, right Accessories: 1x12V55W (H3)
Transit (E_)	01/91->07/00	 9EL 354 072-011 9EL 354 072-021 8GA 002 073-121	1 1 1	Body/lens for indicator light (amber), left Body/lens for indicator light (amber), right Accessories: 1x12V21W (P21W)
Transit (E_) Transit Bus, Box	01/91->07/00	 2VP 354 034-011 2VP 354 034-021 8GD 002 078-121 8GA 002 073-121	1 1 1 1	Combination rearlight, left, with rear fog and reverse light Combination rearlight, right, with rear fog and reverse light Accessories: 1x12V21/5W (P21/5W) 3x12V21W (P21W)





Ford







Manufacturer Model	Model year	Part no.	Pk.	Note
Ford				
Transit (F_) Transit (F_)	12/01->07/06	 1LG 354 024-071 1LG 354 024-081 1LG 354 024-051 1LG 354 024-061 8GJ 002 525-131 8GD 002 078-121 8GP 003 594-121	1 1 1 1 1 1 1	H4 headlight, left, with indicator light, with black cover, for vehicles without headlight leveller H4 headlight, right, with indicator light, with black cover, for vehicles without headlight leveller H4 headlight, left, with indicator light, with black cover, with electric headlight levelling actuator, for vehicles with headlight leveller H4 headlight, right, with indicator light, with black cover, with electric headlight levelling actuator, for vehicles with headlight leveller Spare Parts: 1x12V60/55W (H4) 1x12V21/5W (P21/5W) 1x12V5W (W5W)
Transit (F_)	01/00->07/06	 1LG 354 024-131 1LG 354 024-141 8GJ 002 525-131 8GD 002 078-121 8GP 003 594-121	1 1 1 1 1	H4 headlight, left, with indicator light, with chrome-plated cover, with electric headlight levelling actuator, for vehicles with headlight leveller H4 headlight, right, with indicator light, with chrome-plated cover, with electric headlight levelling actuator, for vehicles with headlight leveller Spare Parts: 1x12V60/55W (H4) 1x12V21/5W (P21/5W) 1x12V5W (W5W)
Transit (F_) Flatbed, Chassis 2-doors	09/02->07/06	 2BA 010 232-011 2BA 010 232-021 8GP 003 594-121	1 1 1	Auxiliary indicator light (amber), left Auxiliary indicator light (amber), right Accessories: 1x12V5W (W5W)
Transit (F_) Bus, Box	01/00->07/06	 2VP 354 037-011 2VP 354 037-021 8GD 002 078-121 8GA 002 073-121	1 1 1 1	Combination rearlight, left, with rear fog and reverse light Combination rearlight, right, with rear fog and reverse light Accessories: 1x12V21/5W (P21/5W) 3x12V21W (P21W)



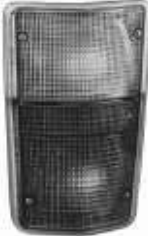

Manufacturer Model	Model year	Part no.	Pk.	Note	
Ford					
Transit Transit Bus, Box Transit Tourneo	07/06->	9EL 171 968-011	1	Body/lens for combination rearlight, left, with rear fog and reverse light	
		9EL 171 968-021	1	Body/lens for combination rearlight, right, with rear fog and reverse light	
		8GA 002 073-121	1	Accessories: 2x12V21W (P21W)	
		8GA 006 841-121	1	1x12V21W (PY21W)	
		8GP 003 594-121	1	1x12V5W (W5W)	
					
Iveco					
Daily II Daily II 29 L, 35 C, 35 S, 40 C, 50 C, 65 C Van	05/99->12/06	2SK 008 208-051	1	Combination rearlight, left, with reverse and rear fog light, with bulbs	
		2SK 008 208-061	1	Combination rearlight, right, with reverse and rear fog light, with bulbs	
		8GA 002 071-121	1	Spare Parts: 1x12V5W (R5W)	
		8GA 006 841-121	1	1x12V21W (PY21W)	
		8GA 002 073-121	1	3x12V21W (P21W)	
					
Mercedes-Benz					
L 405 D - L 911 (T2/L) L 405 D - L 911 (T2/L) L 407 D, L 409, L 410, L 508 D, L 608 D, L 613 D, L 911	08/81->12/88			Headlight, only spare parts available	
		9ES 120 723-001	2	Spare Parts: Lens, left	
		9FH 113 447-011	5	Bulb holder	
		8GD 002 088-131	1	1x12V45/40W (R2)	
		8GD 002 088-251	1	1x24V55/50W (R2)	
		8GP 002 067-121	1	1x12V4W (T4W)	
		8GP 002 067-241	1	1x24V4W (T4W)	
					H4 headlight, only spare parts available
		9ES 120 725-001	2	Spare Parts: Lens, left	
		9ES 120 726-001	2	Lens, right	
9FH 113 447-011	5	Bulb holder			
8GJ 002 525-131	1	1x12V60/55W (H4)			
8GJ 002 525-251	1	1x24V75/70W (H4)			
8GP 002 067-121	1	1x12V4W (T4W)			
8GP 002 067-241	1	1x24V4W (T4W)			
					



Manufacturer Model	Model year	Part no.	Pk.	Note
Mercedes-Benz				
L 405 D - L 911 (T2/L) L 405 D - L 911 (T2/L)	->03/83	2BA 001 275-011 2BA 001 275-021 9EL 101 899-001 9EL 101 900-001 8GA 002 073-121 8GA 002 073-241	2 2 5 5 1 1	Indicator light, left Indicator light, right Spare Parts: Lens, left Lens, right Accessories: 1x12V21W (P21W) 1x24V21W (P21W)
				
L 405 D - L 911 (T2/L) L 405 D, L 406 D, L 407 D, L 408, L 409, L 410, L 508 D, L 608 D, L 613 D, L 911 Van	->06/77	2SD 001 680-271 2SD 001 680-281 9EL 107 368-001 9EL 111 647-001 8GA 002 071-131 8GA 002 073-121	1 1 2 2 1 1	Combination rearlight, left Combination rearlight, right Spare Parts: Lens with seal and screws, left Lens with seal and screws, right Accessories: 1x12V10W (R10W) 2x12V21W (P21W)
				
L 405 D - L 911 (T2/L) L 405 D, L 406 D, L 407 D, L 408, L 409, L 410, L 508 D, L 608 D, L 613 D, L 911 Van	07/77->12/88	9EL 119 874-001 8GA 002 071-131 8GA 002 071-251 8GA 002 073-121 8GA 002 073-241	2 1 1 1 1	Combination rearlight, only spare parts available Spare Parts: Lens with screws Accessories: 1x12V10W (R10W) 1x24V10W (R10W) 2x12V21W (P21W) 2x24V21W (P21W)
				
L 405 D - L 911 (T2/L) L 405 D, L 406 D, L 407 D, L 408, L 409, L 410, L 508 D, L 608 D, L 613 D, L 911 Flatbed	01/68->12/88	2SD 001 680-271 2SE 001 680-301 9EL 107 368-001 9EL 111 647-001 8GA 002 071-131 8GA 002 073-121	1 1 2 2 1 1	Combination rearlight, left, without licence plate light Combination rearlight, right, with licence plate light Spare Parts: Lens with seal and screws, left Lens with seal and screws, right 1x12V10W (R10W) 2x12V21W (P21W)
				



Manufacturer Model	Model year	Part no.	Pk.	Note
Mercedes-Benz				
L 405 D - L 911 (T2/L) L 405 D - L 911 (T2/L) Flatbed	07/77->12/88	2NE 002 589-001 9EL 112 763-001 8GA 002 073-121 8GA 002 073-241	1 5 1 1	Rear fog light Spare Parts: Lens with screws Accessories: 1x12V21W (P21W) 1x24V21W (P21W)
				
L 405 D - L 911 (T2/L) Flatbed	07/77->12/88	2ZR 002 589-011 9EL 112 858-011 8GA 002 073-121 8GA 002 073-241	1 2 1 1	Reverse light Spare Parts: Lens with screws Accessories: 1x12V21W (P21W) 1x24V21W (P21W)
				
L 405 D - L 911 (T2/L) Van	01/68->12/88	2KA 001 378-041 8GM 002 092-121 8GM 002 092-241	4 1 1	Licence plate light Accessories: 1x12V5W (C5W) 1x24V5W (C5W)
				
L 405 D - L 911 (T2/L) Van	01/68->12/88	2KA 003 389-061 9BG 121 587-031 8GA 002 071-131 8GA 002 071-251	2 2 1 1	Licence plate light Spare Parts: Body/lens with screw Accessories: 1x12V10W (R10W) 1x24V10W (R10W)
				
L 405 D - L 911 (T2/L) Van	01/68->12/88	2JA 001 357-002 2JA 001 357-012 8GM 002 091-131 8GM 002 091-251	6 6 1 1	Interior light with switch Interior light without switch Accessories: 2x12V10W (K) 2x24V10W (-)
				
Sprinter 901/902/903/904 Sprinter 901/902/903/904 208 D, 210 D, 212 D, 214 308 D, 310 D, 312 D, 314 408 D, 410 D, 412 D, 414	02/95->03/00	1LH 006 900-031 1LH 006 900-041 9ES 143 775-011 9ES 143 776-011 8GH 002 089-133 8GP 003 594-121	1 1 4 4 1 1	H1 headlight, left, without fog light, with pneumatic headlight levelling actuator, with bulbs H1 headlight, right, without fog light, with pneumatic headlight levelling actuator, with bulbs Spare Parts: Lens, left Lens, right 2x12V55W (H1) 1x12V5W (W5W)
				



Manufacturer Model	Model year	Part no.	Pk.	Note
Mercedes-Benz				
Sprinter 901/902/903/904		1LH 008 010-031	1	H1/H7 headlight, left, with indicator light, without fog light, with electric headlight levelling actuator, with bulbs
Sprinter 901/902/903/904	04/00->08/02			
208 CDI, 211 CDI, 213 CDI, 214, 216 CDI 308 CDI, 311 CDI, 313 CDI, 314, 316 CDI 408 CDI, 411 CDI, 413 CDI, 414, 416 CDI		1LH 008 010-041	1	H1/H7 headlight, right, with indicator light, without fog light, with electric headlight levelling actuator, with bulbs
		8GH 007 157-121	1	1x12V55W (H7)
		8GH 002 089-133	1	1x12V55W (H1)
		8GP 003 594-121	1	1x12V5W (W5W)
		8GA 006 841-121	1	1x12V21W (PY21W)
				Spare Parts:
				1x12V55W (H7)
				1x12V55W (H1)
				1x12V5W (W5W)
				1x12V21W (PY21W)
Sprinter 901/902/903/904		1LH 246 047-031	1	FF®-H7/H3 headlight, left, with indicator light, without fog light, with electric headlight levelling actuator, with bulbs
Sprinter 901/902/903/904	08/02->05/06			
208 CDI, 211 CDI, 213 CDI, 214, 216 CDI 308 CDI, 311 CDI, 313 CDI, 314, 316 CDI 408 CDI, 411 CDI, 413 CDI, 414, 416 CDI		1LH 246 047-041	1	FF®-H7/H3 headlight, right, with indicator light, without fog light, with electric headlight levelling actuator, with bulbs
		1LH 246 047-071	1	FF®-H7/H3 headlight, left, with indicator light, with H7 fog light, with electric headlight levelling actuator, with bulbs
		1LH 246 047-081	1	FF®-H7/H3 headlight, right, with indicator light, with H7 fog light, with electric headlight levelling actuator, with bulbs
		8GH 007 157-121	1	2x12V55W (H7)
		8GH 002 090-133	1	1x12V55W (H3)
		8GP 003 594-121	1	1x12V5W (W5W)
		8GA 006 841-121	1	1x12V21W (PY21W)
				Spare Parts:
				2x12V55W (H7)
				1x12V55W (H3)
				1x12V5W (W5W)
				1x12V21W (PY21W)
Sprinter 901/902/903/904		2BA 007 016-031	1	Indicator light (white), left
Sprinter 901/902/903/904	02/95->03/00	2BA 007 016-041	1	Indicator light (white), right
		8GA 006 841-121	1	Accessories: 1x12V21W (PY21W)
Sprinter 901/902/903/904		2BM 006 692-011	1	Auxiliary indicator light, left
Sprinter 901/902/903/904	02/95->05/06	2BM 006 692-021	1	Auxiliary indicator light, right
		8GA 002 073-121	1	Accessories: 1x12V21W (P21W)



Manufacturer Model	Model year	Part no.	Pk.	Note
Mercedes-Benz				
Sprinter 901/902/903/904		2VD 008 204-111	1	Combination rearlight, left, with licence plate, rear fog, reverse, clearance light, side-marker light, with reflex-reflector and marker reflex-reflector, without centre plug
Sprinter 901/902/903/904 208 D, 210 D, 212 D, 214 308 D, 310 D, 312 D, 314 408 D, 410 D, 412 D, 414 Flatbed	02/95->03/00	2VP 008 204-101	1	Combination rearlight, right, with reverse, clearance light, side-marker light, with reflex-reflector and marker reflex-reflector, without centre plug
Sprinter 901/902/903/904 208 CDI, 211 CDI, 213 CDI, 214, 216 CDI 308 CDI, 311 CDI, 313 CDI, 314, 316 CDI 408 CDI, 411 CDI, 413 CDI, 414, 416 CDI Flatbed	04/00->05/06	9EL 152 891-001	1	Spare Parts: Lens with screws
		8GA 002 071-121	1	Accessories: 3x12V5W (R5W)
		8GA 002 073-121	1	4x12V21W (P21W)
				
Sprinter (906)		1LB 247 012-031	1	FF®-H7 headlight, left, with indicator light, without fog light, with electric headlight levelling actuator, with bulbs
Sprinter (906) 209 CDI, 210 CDI, 211 CDI, 213 CDI, 215 CDI, 216, 216 CDI, 218 CDI, 219 CDI, 224 309 CDI, 310 CDI, 311 CDI, 313 CDI, 315 CDI, 316, 316 CDI, 316 NGT, 318 CDI, 319 CDI, 324 413 CDI, 415 CDI, 416 CDI, 418 CDI, 419 CDI, 424 509 CDI, 510 CDI, 511 CDI, 513 CDI, 515 CDI, 516, 516 CDI, 516 NGT, 518 CDI, 519 CDI, 524	06/06->	1LB 247 012-041	1	FF®-H7 headlight, right, with indicator light, without fog light, with electric headlight levelling actuator, with bulbs
		1LB 247 012-071	1	FF®-H7 headlight, left, with indicator light, with H7 fog light, with electric headlight levelling actuator, with bulbs
		1LB 247 012-081	1	FF®-H7 headlight, right, with indicator light, with H7 fog light, with electric headlight levelling actuator, with bulbs
		8GH 007 157-121	1	Spare Parts: 3x12V55W (H7)
		8GP 003 594-121	1	1x12V5W (W5W)
		8GA 006 841-121	1	1x12V21W (PY21W)
				
Sprinter (906)	06/06->01/07	1NB 008 275-031	1	H11 fog light, left, with bulb
		1NB 008 275-041	1	H11 fog light, right, with bulb
		8GH 008 358-121	1	Spare Parts: 1x12V55W (H11)
				



Manufacturer Model	Model year	Part no.	Pk.	Note
Mercedes-Benz				
Vario 512 D - 816 DA Vario 512 D - 816 DA	09/96->	2BA 007 775-051 2BA 007 775-061	1 1	Indicator light (amber), left Indicator light (amber), right
		8GA 002 073-121 8GA 002 073-241	1 1	Accessories: 1x12V21W (P21W) 1x24V21W (P21W)
Vario 512 D - 816 DA	09/96->	2BM 006 692-011 2BM 006 692-021	1 1	Auxiliary indicator light, left Auxiliary indicator light, right
		8GA 002 073-121 8GA 002 073-241	1 1	Accessories: 1x12V21W (P21W) 1x24V21W (P21W)
Vario 512 D - 816 DA 512 D 612 D, 613 D, 614 D, 615 D, 616 D, 618 D 810 DT, 812 D, 813 D/DA, 814 D/DA, 815 D/DA, 816 D/DA, 818 D/DA O 810, O 812, O 814, O 815	09/96->	2VD 008 204-091 2VP 008 204-081	1 1	Combination rearlight, left, with licence plate, rear fog, reverse, clearance light, side-marker light, with reflex-reflector, marker reflex-reflector and centre plug (middle) Combination rearlight, right, with reverse, clearance light, side-marker light, with reflex-reflector, marker reflex- reflector and centre plug (middle)
		9EL 152 891-001 8GA 002 071-241 8GA 002 073-241	1 1 1	Spare Parts: Lens with screws Accessories: 3x24V5W (R5W) 4x24V21W (P21W)
Vario 512 D - 816 DA 512 D 612 D, 613 D, 614 D, 615 D, 616 D, 618 D 810 DT, 812 D, 813 D/DA, 814 D/DA, 815 D/DA, 816 D/DA, 818 D/DA O 810, O 812, O 814, O 815 Special equipment	09/96->	2VB 004 887-011 2VA 004 887-031 2VP 004 887-021	1 1 1	Combination rearlight, left, with licence plate and rear fog light Combination rearlight, left, with rear fog light Combination rearlight, right, with reverse light
		9EL 131 420-001 9EL 131 420-011 9GT 141 941-001 8GA 002 071-131 8GA 002 071-251 8GA 002 073-121 8GA 002 073-241	1 1 10 1 1 1 1	Spare Parts: Lens with screws, left Lens with screws, right Grommet (to be ordered separately) Accessories: 1x12V10W (R10W) 1x24V10W (R10W) 3x12V21W (P21W) 3x24V21W (P21W)
Vario 512 D - 816 DA	09/96->	2KA 003 389-061	2	Licence plate light
		9BG 121 587-031 8GA 002 071-131 8GA 002 071-251	2 1 1	Spare Parts: Body/lens with screw Accessories: 1x12V10W (R10W) 1x24V10W (R10W)
Vario 512 D - 816 DA	09/96->	2JA 001 357-012	6	Interior light without switch
		8GM 002 091-131 8GM 002 091-131	1 1	Accessories: 2x12V10W (K) 2x12V10W (K)









Manufacturer Model	Model year	Part no.	Pk.	Note
Mercedes-Benz				
Vito (W 639) Vito (W 639)	09/03->08/10	1LG 246 041-031 1LG 246 041-041 8GH 007 157-121 8GP 003 594-121 8GA 002 073-121	1 1 1 1 1	H7 headlight, left, with indicator light, with H7 fog light, with electric headlight levelling actuator, with bulbs H7 headlight, right, with indicator light, with H7 fog light, with electric headlight levelling actuator, with bulbs Spare Parts: 3x12V55W (H7) 1x12V5W (W5W) 1x12V21W (P21W)
Vito (W 639)	09/10->	1LG 009 627-031 1LG 009 627-041 8GH 007 157-121 8GA 006 841-121 8GP 003 594-121	1 1 1 1 1	FF®-H7 headlight, left, with indicator light, with daytime running light, with H7 fog light, with electric headlight levelling actuator, with bulbs FF®-H7 headlight, right, with indicator light, with daytime running light, with H7 fog light, with electric headlight levelling actuator, with bulbs Spare Parts: 3x12V55W (H7) 1x12V21W (PY21W) 1x12V5W (W5W)
Vito (W 639)	09/03->08/10	2SK 964 596-011 2SK 964 596-021 8GD 002 078-121 8GA 002 073-121 8GA 006 841-121	1 1 1 1 1	Combination rearlight, left, with rear fog and reverse light, with bulbs Combination rearlight, right, with rear fog and reverse light, with bulbs Spare Parts: 1x12V21/5W (P21/5W) 2x12V21W (P21W) 1x12V21W (PY21W)
207 D - 410 (T1, TN) 207 D - 410 (T1, TN-series) 207 D, 208, 307 D, 308 209 D, 210, 309 D, 310, 310 D, 407 D, 409 D, 410 208 D, 210 D, 210, 308 D, 310 D, 310, 408 D, 410 D, 410	01/81->02/96 01/81->12/88 08/81->12/88 01/89->02/96	9ES 120 723-001 8GD 002 088-131 8GP 002 067-121 9ES 120 725-001 9ES 120 726-001 8GJ 002 525-131 8GP 002 067-121	2 1 1 2 2 1 1	Headlight, only spare parts available Spare Parts: Lens, left 1x12V45/40W (R2) 1x12V4W (T4W) H4 headlight, only spare parts available Spare Parts: Lens, left Lens, right 1x12V60/55W (H4) 1x12V4W (T4W)





Manufacturer Model	Model year	Part no.	Pk.	Note
Mercedes-Benz				
207 D - 410 (T1, TN)		1ND 122 390-001	1	H3 fog light unit
207 D - 410 (T1, TN-series)	01/81->02/96	8GH 002 090-133 8GH 002 090-251	1 1	Accessories: 1x12V55W (H3) 1x24V70W (H3)
				
207 D - 410 (T1, TN-series)	05/77->02/96	2BA 003 197-011 2BA 003 197-021	1 1	Indicator light, left Indicator light, right
		8GA 002 073-121 8GA 002 073-241	1 1	Accessories: 1x12V21W (P21W) 1x24V21W (P21W)
207 D - 410 (T1, TN-series)	05/77->02/96	2BM 002 652-051	1	Auxiliary indicator light
		8GA 002 073-121 8GA 002 073-241	1 1	Accessories: 1x12V21W (P21W) 1x24V21W (P21W)
207 D - 410 (T1, TN-series)	05/94->02/96	2BM 006 692-011 2BM 006 692-021	1 1	Auxiliary indicator light, left Auxiliary indicator light, right
		8GA 002 073-121 8GA 002 073-241	1 1	Accessories: 1x12V21W (P21W) 1x24V21W (P21W)
207 D - 410 (T1, TN-series)	05/77->02/89	2SD 001 680-271	1	Combination rearlight, left, without licence plate light
207 D, 208, 307 D, 308	05/77->02/89	2SE 001 680-301	1	Combination rearlight, right, without licence plate light
209 D, 210, 309 D, 310, 407 D, 409 D, 410	08/81->02/89	9EL 107 368-001 9EL 111 647-001 8GA 002 071-131 8GA 002 073-121	2 2 1 1	Spare Parts: Lens with seal and screws, left Lens with seal and screws, right 1x12V10W (R10W) 2x12V21W (P21W)
Chassis, Dump truck, Flatbed				



Manufacturer Model	Model year	Part no.	Pk.	Note
Mercedes-Benz				
207 D - 410 (T1, TN) 207 D - 410 (T1, TN-series) 208 D, 210 D, 210, 308 D, 310 D, 310, 408 D, 410 D, 410 Chassis, Dump truck, Flatbed	03/89->02/96	2VB 004 887-011 2VA 004 887-031 2VP 004 887-021 9EL 131 420-001 9EL 131 420-011 9GT 141 941-001 8GA 002 071-131 8GA 002 071-251 8GA 002 073-121 8GA 002 073-241	1 1 1 1 1 1 10 1 1 1 1	Combination rearlight, left, with licence plate and rear fog light Combination rearlight, left, with rear fog light Combination rearlight, right, with reverse light Spare Parts: Lens with screws, left Lens with screws, right Grommet (to be ordered separately) Accessories: 1x12V10W (R10W) 1x24V10W (R10W) 3x12V21W (P21W) 3x24V21W (P21W)
				
207 D - 410 (T1, TN-series)	05/77->02/96	2JA 001 357-012 8GM 002 091-131 8GM 002 091-251	6 1 1	Interior light without switch Accessories: 2x12V10W (K) 2x24V10W (K)
				
507 D - 814 D (T2/LN1) 507 D - 814 D (T2/LN1)	04/86->12/94	1ND 122 390-001 8GH 002 090-133 8GH 002 090-251	1 1 1	H3 fog light unit Accessories: 1x12V55W (H3) 1x24V70W (H3)
				
507 D - 814 D (T2/LN1) Flatbed	04/86->12/94	2BM 002 652-051 8GA 002 073-121 8GA 002 073-241	1 1 1	Auxiliary indicator light Accessories: 1x12V21W (P21W) 1x24V21W (P21W)
				
507 D - 814 D (T2/LN1) Van	04/86->12/94	2BM 002 652-071 2BM 002 652-081 8GA 002 073-121 8GA 002 073-241	1 1 1 1	Auxiliary indicator light, left Auxiliary indicator light, right Accessories: 1x12V21W (P21W) 1x24V21W (P21W)
				
507 D - 814 D (T2/LN1)	05/94->12/94	2BM 006 692-011 2BM 006 692-021 8GA 002 073-121 8GA 002 073-241	1 1 1 1	Auxiliary indicator light, left Auxiliary indicator light, right Accessories: 1x12V21W (P21W) 1x24V21W (P21W)
				



Manufacturer Model	Model year	Part no.	Pk.	Note
Mercedes-Benz				
507 D - 814 D (T2/LN1)		2VB 004 887-011	1	Combination rearlight, left, with licence plate and rear fog light
507 D - 814 D (T2/LN1)	04/86->12/94	2VA 004 887-031	1	Combination rearlight, left, with rear fog light
507 D, 508 D, 510, 609 D, 611 D, 709 D, 711 D, 714 D, 809 D, 811 D, 814 D		2VP 004 887-021	1	Combination rearlight, right, with reverse light
Platform truck Van		9EL 131 420-001	1	Spare Parts: Lens with screws, left
O 609 D, O 611 D, O 614 D	07/87->12/92	9EL 131 420-011	1	Lens with screws, right
		9GT 141 941-001	10	Accessories: Grommet
		8GA 002 071-131	1	1x12V10W (R10W)
		8GA 002 071-251	1	1x24V10W (R10W)
		8GA 002 073-121	1	3x12V21W (P21W)
		8GA 002 073-241	1	3x24V21W (P21W)
507 D - 814 D (T2/LN1)	04/86->12/94	2KA 003 389-061	2	Licence plate light
Van		9BG 121 587-031	2	Spare Parts: Body/lens with screw
O 609 D, O 611 D, O 614 D	07/87->12/92	8GA 002 071-131	1	Accessories: 1x12V10W (R10W)
		8GA 002 071-251	1	1x24V10W (R10W)
507 D - 814 D (T2/LN1)	04/86->12/94	2XS 004 237-291	1	Clearance light (white), left, for front mounting
		2XS 004 237-301	1	Clearance light (white), right, for front mounting
		8GA 002 071-121	1	Accessories: 1x12V5W (R5W)
		8GA 002 071-241	1	1x24V5W (R5W)
507 D - 814 D (T2/LN1)	04/86->12/94	2XS 004 237-311	1	Clearance light (red), left, for rear mounting
		2XS 004 237-321	1	Clearance light (red), right, for rear mounting
		8GA 002 071-121	1	Accessories: 1x12V5W (R5W)
		8GA 002 071-241	1	1x24V5W (R5W)
507 D - 814 D (T2/LN1)	04/86->12/94	2JA 001 357-002	6	Interior light with switch
		2JA 001 357-012	6	Interior light without switch
		8GM 002 091-131	1	Accessories: 2x12V10W (K)
Nissan				
Primastar (X83)		6NM 007 878-501	1	Headlight levelling actuator
Primastar (X83)	09/02->07/06			
				



Manufacturer Model	Model year	Part no.	Pk.	Note
Opel				
Astra F Van Astra F Van (55_)	10/91->08/94	2BM 003 563-111 8GP 003 594-121	1 1	Auxiliary indicator light Accessories: 1x12V5W (W5W)
				
Astra G Box Astra G Box (F70)	01/99->04/05	1LG 007 640-331 1LG 007 640-341 6NM 007 878-351 8GH 005 635-121 8GH 007 157-121 8GA 006 841-121 8GP 003 594-121	1 1 1 1 1 1 1	FF®-H7/HB3 headlight, left, with body/lens for indicator light FF®-H7/HB3 headlight, right, with body/lens for indicator light Accessories: Headlight levelling actuator Spare Parts: 1x12V60W (HB3) 1x12V55W (H7) 1x12V21W (PY21W) 1x12V5W (W5W)
				
Astra G Box (F70)	01/99->04/05	1LG 007 640-631 1LG 007 640-641 6NM 007 878-351 8GH 005 635-121 8GH 007 157-121 8GA 006 841-121 8GP 003 594-121	1 1 1 1 1 1 1	FF®-H7/HB3 headlight, left, with body/lens for indicator light and black frame behind the cover lens FF®-H7/HB3 headlight, right, with body/lens for indicator light and black frame behind the cover lens Accessories: Headlight levelling actuator Spare Parts: 1x12V60W (HB3) 1x12V55W (H7) 1x12V21W (PY21W) 1x12V5W (W5W)
				
Astra G Box (F70)	01/99->04/05	6NM 007 878-351	1	Headlight levelling actuator
				
Astra G Box (F70)	01/99->04/05	1NA 009 029-011 1NA 009 029-021 8GH 002 090-133	1 1 1	FF®-H3 fog light, left, with bulb FF®-H3 fog light, right, with bulb Spare Parts: 1x12V55W (H3)
				
Astra H Box Astra H Box	03/04->	1LG 270 370-331 1LG 270 370-341 8GH 007 157-121 8GH 002 089-133 8GH 008 417-001 8GP 003 594-121	1 1 1 1 1 1	FF®-H7/H1 headlight, left, with integrated indicator light, with electric headlight levelling actuator FF®-H7/H1 headlight, right, with integrated indicator light, with electric headlight levelling actuator Spare Parts: 1x12V55W (H7) 1x12V55W (H1) 1x12V21W (H21W) 1x12V5W (W5W)
				



Opel







Manufacturer Model	Model year	Part no.	Pk.	Note
Opel				
Astra H Box Astra H Box	02/07->	1LG 270 370-631 1LG 270 370-641 8GH 007 157-121 8GH 002 089-133 8GH 008 417-001 8GP 003 594-121	1 1 1 1 1 1	FF®-H7/H1 headlight, left, with integrated indicator light, with electric headlight levelling actuator FF®-H7/H1 headlight, right, with integrated indicator light, with electric headlight levelling actuator Spare Parts: 1x12V55W (H7) 1x12V55W (H1) 1x12V21W (H21W) 1x12V5W (W5W)
Astra H Box	03/04->	5DV 008 290-004	1	Ballast unit
Astra H Box	03/04->	5DD 008 319-501	1	Ignitor, gas discharge bulb
Astra H Box up to chassis no. 72094718, 75086479, 78048187	03/04->	1NA 010 503-011 1NA 010 503-021 8GH 002 090-133	1 1 1	FF®-H3 fog light, left, with bulb FF®-H3 fog light, right, with bulb Spare Parts: 1x12V55W (H3)
Astra H Box	03/04->01/07	2PT 009 305-821 2PT 008 935-001	1 1	Daytime running light set, 2 daytime running lights with bulbs, with harness and covers Spare Parts: Daytime running light









Manufacturer Model	Model year	Part no.	Pk.	Note
Opel				
Combo II Combo II Box/Van up to chassis no. 33999999, 34999999, 36999999	10/01->	1NA 009 031-011	1	FF®-H3 fog light, left, with bulb
		1NA 009 031-021	1	FF®-H3 fog light, right, with bulb
		8GH 002 090-133	1	Spare Parts: 1x12V55W (H3)
Corsa C Box Corsa C Box (F08, W5L) up to chassis no. 33999999, 34999999, 36999999	09/00->	1NA 009 031-011	1	FF®-H3 fog light, left, with bulb
		1NA 009 031-021	1	FF®-H3 fog light, right, with bulb
		8GH 002 090-133	1	Spare Parts: 1x12V55W (H3)
Kadett E Kadett E Combo (38_, 48_) Kadett E Box (37_, 47_)	01/86->07/94	2BM 003 563-111	1	Auxiliary indicator light
	08/84->09/92	8GP 003 594-121	1	Accessories: 1x12V5W (W5W)
Kadett E Combo (38_, 48_) Kadett E Box (37_, 47_)	01/86->07/94	2KA 004 434-031	1	Licence plate light
	08/84->09/92	8GP 002 067-121	1	Accessories: 1x12V4W (T4W)
Movano B Movano B	05/10->	1LR 010 117-111	1	H7/H1 headlight, left, with indicator light, with daytime running light, without electric headlight levelling actuator
		1LR 010 117-121	1	H7/H1 headlight, right, with indicator light, with daytime running light, without electric headlight levelling actuator
		8GH 007 157-121	1	Spare Parts: 1x12V55W (H7)
		8GH 002 089-133	1	1x12V55W (H1)
		8GA 006 841-121	1	1x12V21W (PY21W)
		8GA 002 073-121	1	1x12V21W (P21W)
		8GP 003 594-121	1	1x12V5W (W5W)



Manufacturer Model	Model year	Part no.	Pk.	Note
Opel				
Vivaro (J7/E7/F7) Vivaro (J7/E7/F7)	08/01->07/06		6NM 007 878-501	1 Headlight levelling actuator
Peugeot				
Boxer Boxer	04/06->		2PT 010 043-811	1 Daytime running light set LEDayLine®
Partner Box (5) Partner Box (5)	11/02->		1LG 010 196-031 1LG 010 196-041 8GJ 002 525-131 8GA 006 841-121 8GP 003 594-121	1 H4 headlight, left, with indicator light, with electric headlight levelling actuator 1 H4 headlight, right, with indicator light, with electric headlight levelling actuator Spare Parts: 1 1x12V60/55W (H4) 1 1x12V21W (PY21W) 1 1x12V5W (W5W)
Renault				
Clio II Box (SB0/1/2_) Clio II Box (SB0/1/2_)	09/98->05/01		1LE 007 350-111 1LE 007 350-121 6NM 007 878-501 8KA 152 601-001 8GJ 002 525-131 8GP 003 594-121 8GA 006 841-121	1 H4 headlight, left, with indicator light, without headlight levelling actuator, without bulbs 1 H4 headlight, right, with indicator light, without headlight levelling actuator, without bulbs Accessories: 1 Headlight levelling actuator 1 Lead for converting from H4 headlight to DE@-HB3/H7 headlight 1 1x12V60/55W (H4) 1 1x12V5W (W5W) 1 1x12V21W (PY21W)
Clio II Box (SB0/1/2_)	09/98->05/01		1LL 007 510-071 1LL 007 510-081 6NM 007 878-501 8KA 152 601-001 8GH 005 635-121 8GH 007 157-121 8GP 003 594-121 8GA 006 841-121	1 DE@-HB3/H7 headlight, left, with indicator light, without headlight levelling actuator, without bulbs 1 DE@-HB3/H7 headlight, right, with indicator light, without headlight levelling actuator, without bulbs Accessories: 1 Headlight levelling actuator 1 Lead for converting from H4 headlight to DE@-HB3/H7 headlight 1 1x12V60W (HB3) 1 1x12V55W (H7) 1 1x12V5W (W5W) 1 1x12V21W (PY21W)









Manufacturer Model	Model year	Part no.	Pk.	Note
Renault				
Clio II Box (SB0/1/2_) Clio II Box (SB0/1/2_)	06/01->12/03	 1LB 008 461-551 1LB 008 461-561 6NM 007 878-501 8GH 007 157-121 8GH 002 089-133 8GP 003 594-121 8GA 006 841-121	1 1 1 1 1 1 1 1	H1/H7 headlight, left, with indicator light, without headlight levelling actuator, with bulbs H1/H7 headlight, right, with indicator light, without headlight levelling actuator, with bulbs Accessories: Headlight levelling actuator Spare Parts: 1x12V55W (H7) 1x12V55W (H1) 1x12V5W (W5W) 1x12V21W (PY21W)
Clio II Box (SB0/1/2_)	01/04->05/09	 1LB 008 461-751 1LB 008 461-761 6NM 007 878-501 8GH 007 157-121 8GH 002 089-133 8GP 003 594-121 8GA 006 841-121	1 1 1 1 1 1 1 1	H1/H7 headlight, left, with indicator light, without headlight levelling actuator, with bulbs H1/H7 headlight, right, with indicator light, without headlight levelling actuator, with bulbs Accessories: Headlight levelling actuator Spare Parts: 1x12V55W (H7) 1x12V55W (H1) 1x12V5W (W5W) 1x12V21W (PY21W)
Clio II Box (SB0/1/2_)	09/98->	 6NM 007 878-501	1	Headlight levelling actuator
Kangoo Express (FC0/1_) Kangoo Express (FC0/1_)	03/98->01/08	 6NM 007 878-501	1	Headlight levelling actuator
Master II Master II	07/98->10/03	 6NM 007 878-501	1	Headlight levelling actuator



Renault - Seat



Manufacturer Model	Model year	Part no.	Pk.	Note
Renault				
Master IV Master IV	02/10->	 1LR 010 117-111 1LR 010 117-121 8GH 007 157-121 8GH 002 089-133 8GA 006 841-121 8GA 002 073-121 8GP 003 594-121	1 1 1 1 1 1	H7/H1 headlight, left, with indicator light, with daytime running light, without electric headlight levelling actuator H7/H1 headlight, right, with indicator light, with daytime running light, without electric headlight levelling actuator Spare Parts: 1x12V55W (H7) 1x12V55W (H1) 1x12V21W (PY21W) 1x12V21W (P21W) 1x12V5W (W5W)
Trafic II (JL/EL/FL) Trafic II (JL/EL/FL)	03/01->07/06	 6NM 007 878-501	1	Headlight levelling actuator
Twingo Box (S06_) Twingo Box (S06_)	03/93->	 6NM 007 878-501	1	Headlight levelling actuator
Twingo Box (S06_)	03/93->04/96	 1NL 007 186-027 9HD 149 253-007 8JD 156 150-807 8GH 002 090-133	30 160 1 1	DE®-H3 fog light with bulb Spare Parts: Plastic cap Counterplug set (to be ordered separately) 1x12V55W (H3)
19 II Box (S53_) 19 II Box (S53_)	03/92->12/95	 6NM 007 878-501	1	Headlight levelling actuator
Seat				
Inca (6K9) Inca (6K9)	11/95->06/03	 1NA 961 557-751 1NA 961 557-761 8GH 002 090-133	1 1 1	H3 fog light, left H3 fog light, right Accessories: 2x12V55W (H3)
Inca (6K9)	11/95->06/03	 9EL 147 073-001 8GP 003 594-121	2 1	Body/lens for auxiliary indicator light (amber) Accessories: 1x12V5W (W5W)







Manufacturer Model	Model year	Part no.	Pk.	Note
Skoda				
Fabia Praktik Fabia Praktik	04/02->		6NM 007 878-521	1 Headlight levelling actuator
Fabia Praktik Chassis no. -> 6Y-54421 759	08/04->		1N0 270 481-051 1N0 270 481-061 8GH 005 636-121	1 HB4 fog light, left, with bulb 1 HB4 fog light, right, with bulb Spare Parts: 1x12V51W (HB4)
Fabia Praktik Chassis no. 6Y-54421 760 -> 6Y-7B452 577			1N0 271 247-051 1N0 271 247-061 8GH 005 636-121	1 FF@-HB4 fog light, left, with bulb 1 FF@-HB4 fog light, right, with bulb Spare Parts: 1x12V51W (HB4)
Fabia Praktik	04/02->08/04		9EL 171 977-011 9EL 171 977-021 8GD 004 772-121 8GA 002 073-121 8GA 006 841-121	1 Body/lens for combination rearlight, left, with rear fog and reverse light 1 Body/lens for combination rearlight, right, with rear fog and reverse light Accessories: 1 1x12V21/4W (P21/4W) 1 2x12V21W (P21W) 1 1x12V21W (PY21W)
Fabia Praktik	08/04->		9EL 171 975-011 9EL 171 975-021 8GD 004 772-121 8GA 002 073-121 8GA 006 841-121	1 Body/lens for combination rearlight, left, with rear fog and reverse light 1 Body/lens for combination rearlight, right, with rear fog and reverse light Accessories: 1 1x12V21/4W (P21/4W) 1 2x12V21W (P21W) 1 1x12V21W (PY21W)



Skoda



Manufacturer Model	Model year	Part no.	Pk.	Note
Skoda				
Praktik Praktik for PR no. 8BF, 8Q1	03/10->	 1LD 010 417-351 1LD 010 417-361 8GJ 002 525-131 8GP 003 594-121 8GA 006 841-121	1 1 1 1 1	FF®-H4 headlight, left, with indicator light, with electric headlight levelling actuator FF®-H4 headlight, right, with indicator light, with electric headlight levelling actuator Accessories: 1x12V60/55W (H4) 1x12V5W (W5W) 1x12V21W (PY21W)
Praktik for PR no. 8JK, Q1 (-) bend lighting	03/10->	1LL 010 417-391 1LL 010 417-401 8GH 007 157-121 8GP 003 594-121	1 1 1 1	FF®-H7 headlight, left, with indicator light, without bend lighting, with electric headlight levelling actuator FF®-H7 headlight, right, with indicator light, without bend lighting, with electric headlight levelling actuator Accessories: 2x12V55W (H7) 1x12V5W (W5W) 1x12V21W (PY21W) Long Life
Praktik for PR no. 8JK, 8Q7 (+) bend lighting	03/10->	 1ZL 010 417-431 1ZL 010 417-441 8GH 007 157-121 8GP 003 594-121	1 1 1 1	FF®-H7 headlight, left, with indicator light, with bend lighting, with electric headlight levelling actuator FF®-H7 headlight, right, with indicator light, with bend lighting, with electric headlight levelling actuator Accessories: 2x12V55W (H7) 1x12V5W (W5W) 1x12V21W (PY21W) Long Life
Praktik	03/07->03/10	 1N0 354 018-011 1N0 354 018-021 8GH 008 356-121	1 1 1	H8 fog light, left, with cornering light H8 fog light, right, with cornering light Accessories: 1x12V35W (H8)
Praktik	03/07->03/10	 1N0 271 247-051 1N0 271 247-061 8GH 005 636-121	1 1 1	FF®-HB4 fog light, left, with bulb FF®-HB4 fog light, right, with bulb Spare Parts: 1x12V51W (HB4)



Manufacturer Model	Model year	Part no.	Pk.	Note	
Skoda					
Praktik Praktik	03/07->		9EL 354 077-011	1	Body/lens for combination rearlight, left, with rear fog and reverse light
			9EL 354 077-021	1	Body/lens for combination rearlight, right, with rear fog and reverse light
			8GA 006 841-121	1	1x12V21W (PY21W)
			8GA 002 073-121	1	3x12V21W (P21W)
		8GP 003 594-121	1	2x12V5W (W5W)	
Vauxhall					
Astravan Mk IV (G) Astravan Mk IV (G)	08/98->		1LG 007 640-331	1	FF@-H7/HB3 headlight, left, with body/lens for indicator light
			1LG 007 640-341	1	FF@-H7/HB3 headlight, right, with body/lens for indicator light
			8GH 005 635-121	1	1x12V60W (HB3)
			8GH 007 157-121	1	1x12V55W (H7)
			8GA 006 841-121	1	1x12V21W (PY21W)
			8GP 003 594-121	1	1x12V5W (W5W)
Astravan Mk IV (G) Astravan Mk IV (G)	08/98->		1LG 007 640-631	1	FF@-H7/HB3 headlight, left, with body/lens for indicator light and black frame behind the cover lens
			1LG 007 640-641	1	FF@-H7/HB3 headlight, right, with body/lens for indicator light and black frame behind the cover lens
			8GH 005 635-121	1	1x12V60W (HB3)
			8GH 007 157-121	1	1x12V55W (H7)
			8GA 006 841-121	1	1x12V21W (PY21W)
			8GP 003 594-121	1	1x12V5W (W5W)
Astravan Mk IV (G)	08/98->		6NM 007 878-351	1	Headlight levelling actuator
Astravan Mk IV (G)	08/98->		1NA 009 029-011	1	FF@-H3 fog light, left, with bulb
			1NA 009 029-021	1	FF@-H3 fog light, right, with bulb
			8GH 002 090-133	1	Spare Parts: 1x12V55W (H3)





Vauxhall



Manufacturer Model	Model year	Part no.	Pk.	Note
Vauxhall				
Astravan Mk V (H) Astravan Mk V (H)	03/05->	 1LG 270 370-331 1LG 270 370-341 8GH 007 157-121 8GH 002 089-133 8GH 008 417-001 8GP 003 594-121	1 1	FF®-H7/H1 headlight, left, with integrated indicator light, with electric headlight levelling actuator FF®-H7/H1 headlight, right, with integrated indicator light, with electric headlight levelling actuator Spare Parts: 1x12V55W (H7) 1x12V55W (H1) 1x12V21W (H21W) 1x12V5W (W5W)
Astravan Mk V (H)	02/07->	 1LG 270 370-631 1LG 270 370-641 8GH 007 157-121 8GH 002 089-133 8GH 008 417-001 8GP 003 594-121	1 1	FF®-H7/H1 headlight, left, with integrated indicator light, with electric headlight levelling actuator FF®-H7/H1 headlight, right, with integrated indicator light, with electric headlight levelling actuator Spare Parts: 1x12V55W (H7) 1x12V55W (H1) 1x12V21W (H21W) 1x12V5W (W5W)
Astravan Mk V (H)	03/05->	 5DV 008 290-004	1	Ballast unit
Astravan Mk V (H)	03/05->	 5DD 008 319-501	1	Ignitor, gas discharge bulb
Astravan Mk V (H) up to chassis no. 72094718, 75086479, 78048187	03/05->	 1NA 010 503-011 1NA 010 503-021 8GH 002 090-133	1 1 1	FF®-H3 fog light, left, with bulb FF®-H3 fog light, right, with bulb Spare Parts: 1x12V55W (H3)
Astravan Mk V (H)	03/05->01/07	 2PT 009 305-821 2PT 008 935-001	1 1	Daytime running light set, 2 daytime running lights with bulbs, with harness and covers Spare Parts: Daytime running light



Manufacturer Model	Model year	Part no.	Pk.	Note
Vauxhall				
Combo II Combo II up to chassis no. 33999999, 34999999, 36999999 	09/01->	1NA 009 031-011	1	FF®-H3 fog light, left, with bulb
		1NA 009 031-021	1	FF®-H3 fog light, right, with bulb
		8GH 002 090-133	1	Spare Parts: 1x12V55W (H3)
Corsavan Mk III Corsavan Mk III up to chassis no. 33999999, 34999999, 36999999 	09/00->	1NA 009 031-011	1	FF®-H3 fog light, left, with bulb
		1NA 009 031-021	1	FF®-H3 fog light, right, with bulb
		8GH 002 090-133	1	Spare Parts: 1x12V55W (H3)
Volkswagen				
Caddy III (2K_, 2CA, 2CH) Caddy III (2K_, 2CA, 2CH) up to chassis no. 2K-B-5000 	03/04->08/10	1LL 010 203-031	1	H1/H7 headlight, left, with indicator light, with electric headlight levelling actuator
		1LL 010 203-041	1	H1/H7 headlight, right, with indicator light, with electric headlight levelling actuator
		8GH 007 157-121	1	Spare Parts: 1x12V55W (H7)
		8GH 002 089-133	1	1x12V55W (H1)
		8GA 006 841-121	1	1x12V21W (PY21W)
		8GP 003 594-121	1	1x12V5W (W5W)
Caddy III Box (2KA, 2KH, 2CA, 2CH) from chassis no. 2K-B-200 001	09/10->	1LL 010 551-031	1	FF®-H4 headlight, left, with indicator light, with daytime running light, with electric headlight levelling actuator, with bulbs
		1LL 010 551-041	1	FF®-H4 headlight, right, with indicator light, with daytime running light, with electric headlight levelling actuator, with bulbs
		8GJ 002 525-131	1	Spare Parts: 1x12V60/55W (H4)
		8GA 006 841-121	1	1x12V21W (PY21W)
		8GA 002 073-121	1	1x12V21W (P21W)



Volkswagen



Manufacturer Model	Model year	Part no.	Pk.	Note
Volkswagen				
Caddy III (2K_, 2CA, 2CH) Caddy III (2K_, 2CA, 2CH) up to chassis no. 2K-5-060 000	03/04->12/04	1N0 270 596-051 1N0 270 596-061 8GH 008 358-121	1 1 1	DE®-H11 fog light, left, with bulb DE®-H11 fog light, right, with bulb Spare Parts: 1x12V55W (H11)
				
Caddy III (2K_, 2CA, 2CH) from chassis no. 2K-5-060 001	12/04->08/10	1N0 271 289-031 1N0 271 289-041 8GH 005 636-121	1 1 1	FF®-HB4 fog light, left, with bulb FF®-HB4 fog light, right, with bulb Spare Parts: 1x12V51W (HB4)
				
Caddy III (2K_, 2CA, 2CH) Vehicles with tailgate up to chassis no. 2K-B-5000	03/04->08/10	2VP 354 043-011 2VP 354 043-021 8GD 004 772-121 8GA 002 073-121 8GA 006 841-121	1 1 1 1 1	Combination rearlight, left, with rear fog and reverse light Combination rearlight, right, with rear fog and reverse light Accessories: 1x12V21/4W (P21/4W) 2x12V21W (P21W) 1x12V21W (PY21W)
				
Caddy III Box (2KA, 2KH, 2CA, 2CH) Vehicles with hatch door up to chassis no. 2K-B-5000	03/04->08/10	2VP 354 042-011 2VP 354 042-021 8GD 004 772-121 8GA 002 073-121 8GA 006 841-121	1 1 1 1 1	Combination rearlight, left, with rear fog and reverse light Combination rearlight, right, with rear fog and reverse light Accessories: 1x12V21/4W (P21/4W) 2x12V21W (P21W) 1x12V21W (PY21W)
				



Manufacturer Model	Model year	Part no.	Pk.	Note
Volkswagen				
Crafter (2E_/2F_) Crafter (2E_/2F_)	04/06->	 1LR 247 017-071 1LR 247 017-081 8GH 007 157-121 8GA 006 841-121 8GP 003 594-121	1 1 1 1 1	FF®-H7 headlight, left, with indicator light, with electric headlight levelling actuator, with bulbs FF®-H7 headlight, right, with indicator light, with electric headlight levelling actuator, with bulbs Spare Parts: 2x12V55W (H7) 1x12V21W (PY21W) 1x12V5W (W5W)
Crafter (2E_/2F_)	04/06->	 1N0 271 247-051 1N0 271 247-061 8GH 005 636-121	1 1 1	FF®-HB4 fog light, left, with bulb FF®-HB4 fog light, right, with bulb Spare Parts: 1x12V51W (HB4)
LT I LT I	08/75->08/85	 1L8 003 060-561 9GH 116 966-011 9FF 126 444-001 8GD 002 088-131 8GP 002 067-121 1L8 003 060-691 9GH 116 966-011 9FF 126 444-001 8GJ 002 525-131 8GP 002 067-121	1 10 10 1 1 1 10 10 1 1	Headlight Spare Parts: Cap Bulb socket for side light 1x12V45/40W (R2) 1x12V4W (T4W) H4 headlight Spare Parts: Cap Accessories: Bulb socket for side light Spare Parts: 1x12V60/55W (H4) 1x12V4W (T4W)
LT I Van	10/75->01/93	 9EL 113 065-001 8GD 002 078-121 8GA 002 073-121	1 1 1	Combination rearlight with reverse light, only spare parts available Spare Parts: Lens Accessories: 1x12V21/5W (P21/5W) 2x12V21W (P21W)







Manufacturer Model	Model year	Part no.	Pk.	Note
Volkswagen				
LT I LT I Flatbed	83->04/96	 9EL 122 689-051 9EL 122 689-021 8GA 002 071-131 8GA 002 073-121	2 2 1 1	Combination rearlight, only spare parts available Spare Parts: Lens for rear, reflex-reflector, stop, indicator and reverse light Lens for rear, reflex-reflector, stop, indicator, reverse and rear fog light Accessories: 1x12V10W (R10W) 4x12V21W (P21W)
LT I LT I	04/75->04/96	 2JA 002 931-031 8GM 002 091-131	5 1	Interior light Accessories: 1x12V10W (K)
LT II LT II Bus, Van	05/96->07/06	 9EL 270 197-011 9EL 270 198-011 8GD 002 078-241 8GA 002 073-241	1 1 1 1	Body/lens for combination rearlight, left, with rear fog and reverse light Body/lens for combination rearlight, right, with rear fog and reverse light Accessories: 1x24V21/5W (P21/5W) 3x24V21W (P21W)
LT II Flatbed Chassis with cab	05/96->07/06	 2VD 008 204-131 2VP 008 204-121 9EL 152 889-001 8GA 002 071-241 8GA 002 073-241	1 1 1 1 1	Combination rearlight, left, with licence plate, rear fog, reverse, clearance light, side-marker light, with reflex-reflector and marker reflex-reflector Combination rearlight, right, with reverse, clearance light, side-marker light, with reflex-reflector and marker reflex-reflector Spare Parts: Lens with screws Accessories: 3x24V5W (R5W) 4x24V21W (P21W)
Polo Box (86CF) Polo Box (86CF)	08/92->08/94	 1NL 006 280-051 1NL 006 280-061 8GH 002 090-133	1 1 1	DE®-H3 fog light, left, with bulb DE®-H3 fog light, right, with bulb Spare Parts: 1x12V55W (H3)
Polo Box (86CF) Polo Box (86CF)	08/92->08/94	 2BM 003 647-801 2BM 003 647-021 8GP 003 594-121	1 1 1	Auxiliary indicator light set (amber), with bulbs Spare Parts: Auxiliary indicator light (amber) 2x12V5W (W5W)







Manufacturer Model	Model year	Part no.	Pk.	Note
Volkswagen				
Polo Box (86CF) Polo Box (86CF)	08/92->08/94	2BM 006 759-001 8GP 003 594-121	5 1	Auxiliary indicator light (grey), with bulb Spare Parts: 2x12V5W (W5W)
				
Polo Box (6NF) Polo Box (6NF)	09/94->12/99	1LF 962 489-151 1LF 962 489-161 1LF 962 489-171 1LF 962 489-181 8GJ 002 525-131 8GP 003 594-121	1 1 1 1 1 1	H4 headlight, left, with electr. headlight leveller, with 5W bulb for side light H4 headlight, right, with electr. headlight leveller, with 5W bulb for side light H4 headlight, left, without electr. headlight leveller, with 5W bulb for side light H4 headlight, right, without electr. headlight leveller, with 5W bulb for side light Spare Parts: 1x12V60/55W (H4) Accessories: 1x12V5W (W5W)
				
Polo Box (6NF) all models with small bumper	09/94->12/99	1NA 962 530-011 1NA 962 530-021 8GH 002 090-133	1 1 1	FF®-H3 fog light, left, with bulb FF®-H3 fog light, right, with bulb Spare Parts: 1x12V55W (H3)
				
Polo Box (6NF) all models with large bumper	09/94->12/99	1NA 962 490-011 1NA 962 490-021 8GH 002 090-133	1 1 1	FF®-H3 fog light, left, with bulb FF®-H3 fog light, right, with bulb Spare Parts: 1x12V55W (H3)
				
Polo Box (6NF) Basic	09/94->12/99	9EL 962 839-031 9EL 962 840-031 8GA 002 073-121	1 1 1	Body/lens for indicator light (amber), left Body/lens for indicator light (amber), right Accessories: 1x12V21W (P21W)
				









Manufacturer Model	Model year	Part no.	Pk.	Note
Volkswagen				
Polo Box (6NF) Polo Box (6NF) Basic	09/94->12/99	2BA 962 625-821 9EL 962 839-021 9EL 962 840-021 8GA 006 841-121	1 1 1 1	Indicator light set (white), with bulbs Spare Parts: Body/lens (white), left Body/lens (white), right 2x12V21W (PY21W)
				
Polo Box (6NF) Basic with special equipment Styling	09/94->12/99	9EL 962 839-021 9EL 962 840-021 8GA 006 841-121	1 1 1	Body/lens for indicator light (white), left Body/lens for indicator light (white), right Accessories: 1x12V21W (PY21W)
				
Polo Box (6NF)	09/94->12/99	9EL 147 073-001 8GP 003 594-121	2 1	Body/lens for auxiliary indicator light (amber) Accessories: 1x12V5W (W5W)
				
Polo Box (6NF)	09/94->12/99	9EL 147 073-801 8GP 003 594-121	1 1	Body/lens set for auxiliary indicator light (grey) Accessories: 2x12V5W (W5W)
				
Transporter (T2) Transporter (T2)	08/73->07/79	1L8 003 060-561 9GH 116 966-011 9FF 126 444-001 8GD 002 088-131 8GP 002 067-121 1L8 003 060-691 9GH 116 966-011 9FF 126 444-001 8GJ 002 525-131 8GP 002 067-121	1 10 10 1 1 1 10 10 1 1	Headlight Spare Parts: Cap Bulb socket for side light 1x12V45/40W (R2) 1x12V4W (T4W) H4 headlight Spare Parts: Cap Accessories: Bulb socket for side light Spare Parts: 1x12V60/55W (H4) 1x12V4W (T4W)
				



Manufacturer Model	Model year	Part no.	Pk.	Note
Volkswagen				
Transporter (T2) Transporter (T2)	08/71->07/79	 9EL 113 065-001 8GD 002 078-121 8GA 002 073-121	1 1 1	Combination rearlight with reverse light, only spare parts available Spare Parts: Lens Accessories: 1x12V21/5W (P21/5W) 2x12V21W (P21W)
Transporter (T3) Transporter (T3)	05/79->07/92	 9EL 122 377-011 8GA 002 073-121	1 1	Indicator light, only spare parts available Spare Parts: Body/lens, left Accessories: 1x12V21W (P21W)
Transporter (T3)	05/79->07/92	 9EL 122 149-011 9EL 122 150-011 8GA 002 071-131 8GA 002 073-121	1 1 1 1	Combination rearlight, with rear fog and reverse light, only spare parts available Spare Parts: Body/lens, left Body/lens, right Accessories: 1x12V10W (R10W) 4x12V21W (P21W)
Transporter (T3)	05/79->07/92	 2JA 002 931-031 8GM 002 091-131	5 1	Interior light Accessories: 1x12V10W (K)
Transporter (T4) Transporter (T4) PR no. AC0 with short front-end	09/90->04/03	 1LJ 006 051-191 1LJ 006 051-201 8GJ 002 525-131 8GP 002 067-121	1 1 1 1	H4 headlight, left H4 headlight, right Spare Parts: 1x12V60/55W (H4) 1x12V4W (T4W)





Manufacturer Model	Model year	Part no.	Pk.	Note
Volkswagen				
Transporter (T4) Transporter (T4) Chassis no. 70-T-200 001 -> 70-1-048 000	01/96->01	6NM 007 282-211	1	Headlight levelling actuator
				
Transporter (T4) up to 1.65t (short wheelbase)	09/90->	1NL 006 250-051 1NL 006 250-061	1 1	DE@-H3 fog light, left DE@-H3 fog light, right
			8GH 002 090-133	1 Accessories: 1x12V55W (H3)
Transporter (T4) PR no. AC0 with short front-end	09/90->04/03	9EL 136 401-011 9EL 136 402-011	1 1	Body/lens for indicator light (amber), left Body/lens for indicator light (amber), right
			8GA 002 073-121	1 Accessories: 1x12V21W (P21W)
Transporter (T4)	09/90->04/03	9EL 146 371-001 9EL 146 372-001	1 1	Body/lens for combination rearlight (amber/red), left Body/lens for combination rearlight (amber/red), right
			8GD 002 078-121 8GA 002 073-121	1 1 Accessories: 1x12V21/5W (P21/5W) 2x12V21W (P21W)
Transporter (T4)	09/90->04/03	9EL 146 373-001	1	Body/lens for rear fog light
			8GA 002 073-121	1 Accessories: 1x12V21W (P21W)
Transporter (T4) Flatbed	09/90->04/03	9EL 122 689-051 9EL 122 689-021	2 2	Combination rearlight, only spare parts available Spare Parts: Lens for rear, reflex-reflector, stop, indicator and reverse light Lens for rear, reflex-reflector, stop, indicator, reverse and rear fog light
			8GA 002 071-131 8GA 002 073-121	1 1 Accessories: 1x12V10W (R10W) 4x12V21W (P21W)



Manufacturer Model	Model year	Part no.	Pk.	Note
Volkswagen				
Transporter (T5)		1N0 270 481-051	1	FF®-HB4 fog light, left, with bulb
Transporter (T5)	04/03->	1N0 270 481-061	1	FF®-HB4 fog light, right, with bulb
up to chassis no. 7H-5-020 000, 7J-5-015 000		8GH 005 636-121	1	Spare Parts: 1x12V51W (HB4)
				
Transporter (T5)	04/03->10/09	1N0 271 247-051	1	FF®-HB4 fog light, left, with bulb
Chassis no. 7H-5-020 001, -> 7H-A-050 000, 7J-5-015 001 -> 7J-A-010 000		1N0 271 247-061	1	FF®-HB4 fog light, right, with bulb
		8GH 005 636-121	1	Spare Parts: 1x12V51W (HB4)
				
Transporter (T5)	04/03->10/09	2SK 008 579-091	1	Combination rearlight (amber/red), left, with rear fog and reverse light, with bulbs
Vehicles with tailgate		2SK 008 579-101	1	Combination rearlight (amber/red), right, with rear fog and reverse light, with bulbs
		8GA 002 073-121	1	Spare Parts: 3x12V21W (P21W)
		8GD 004 772-121	1	1x12V21/4W (P21/4W)
				
Transporter (T5)	04/03->10/09	2SK 008 579-131	1	Combination rearlight (red/white), left, with rear fog and reverse light, with bulbs
Vehicles with tailgate		2SK 008 579-141	1	Combination rearlight (red/white), right, with rear fog and reverse light, with bulbs
		8GA 002 073-121	1	Spare Parts: 3x12V21W (P21W)
		8GD 004 772-121	1	1x12V21/4W (P21/4W)
				



Manufacturer Model	Model year	Part no.	Pk.	Note	
Volkswagen					
Transporter (T5) Transporter (T5) Vehicles with tailgate	04/03->10/09	2SK 008 579-151 2SK 008 579-161 8GD 002 078-121 8GA 002 073-121	1 1 1 1 1	Design combination rearlight (silver/red), left, with rear fog and reverse light, with bulbs Design combination rearlight (silver/red), right, with rear fog and reverse light, with bulbs Spare Parts: 1x12V21/5W (P21/5W) 2x12V21W (P21W) 1x12V21W (P21W) Silver Vision	
	Transporter (T5) Vehicles with gull-wing doors	04/03->10/09	2SK 008 579-111 2SK 008 579-121 8GA 002 073-121 8GD 004 772-121	1 1 1 1	Combination rearlight (amber/red), left, with rear fog and reverse light, with bulbs Combination rearlight (amber/red), right, with rear fog and reverse light, with bulbs Spare Parts: 3x12V21W (P21W) 1x12V21/4W (P21/4W)
					



Headlights, Signal and Sundry Lights for Commercial Vehicles and Buses



List of Manufacturers/Page

3.02 -3.03

Headlights, Signal and Sundry Lights -
Application Chart for Commercial Vehicles and Buses

3.04 - 3.81



List of Manufacturers/Page







Manufacturer	Model year	Page	Manufacturer	Model year	Page
DAF			MAN		
Older models		3.04	19.242 - 48.462 (F 90)	06/86->	3.32 - 3.35
CF 65, CF 75, CF 85	01/01->	3.04	19.233 - 41.464 (F 2000)	01/94->	3.35 - 3.36
F 2100 - F 2800	10/86->	3.05	18.310 - 41.660 (TGA)	04/00->05/05	3.37 - 3.38
LF 45, LF 55	01/01->	3.05 - 3.06	MAN/VW		
XF 95	09/02->12/06	3.06	6.90 F - 9.136 F	10/79->08/87	3.38
XF 105	10/05->	3.07	6.90 F - 9.150 F	10/79->91	3.38
65, 75, 85	01/93->02/98	3.07 - 3.08	Mercedes-Benz		
65 CF, 75 CF, 85 CF	02/98->12/00	3.08 - 3.09	Actros	09/96->10/02	3.38 - 3.39
95	09/87->01/98	3.09	Actros MP2/MP3	10/02->	3.40 - 3.43
95 XF	01/97->09/02	3.10	Atego	01/98->10/04	3.43 - 3.44
Iveco			Atego II	10/04->	3.44
EuroCargo 60 E - 320 E	01/91->	3.10	Axor	01/02->10/04	3.45
EuroStar LD 190 - LD 440	01/93->	3.11	Axor II	10/04->	3.45 - 3.46
EuroTech MH 180 - MT 400	01/92->	3.11	Cab-behind-enginevehicles 911 - 2624		3.46 - 3.48
EuroTrakker MP 190 - MP 410	01/93->	3.11	LP 608 - LP 1113 (LP)	10/69->12/84	3.48 - 3.49
Stralis	02/02->	3.11	O 309	01/68->02/89	3.50 - 3.51
Iveco Ford			O 404	09/91->10/99	3.51
190 - 210		3.12	O 405	09/84->	3.51 - 3.52
Iveco Magirus			O 405 VÖV II	01/84->	3.52 - 3.53
75-9 A - 160 M13 FS	09/75->	3.12 - 3.13	O 407	03/87->11/01	3.53 - 3.54
120-13 ANW - 330-30 ANW	01/83->	3.14 - 3.15	Unimog		3.54 - 3.55
130 D - 310 D(P/PA-series)	01/71->12/82	3.15 - 3.17	507 D - 814 D (T2/LN1)	04/86->12/94	3.55 - 3.56
130 D 9 FL - 340 D 22	05/73->	3.17 - 3.18	709 - 2024 (LK/LN2)	01/84->12/98	3.57 - 3.59
180-24 - 320 M(T-series)		3.19 - 3.20	1013 - 3850 (NG)	08/73->08/88	3.60 - 3.65
MAN			1222 - 4850 (MK, SK)	07/87->09/96	3.66 - 3.70
EL 202		3.20	Neoplan		
Lion's Family		3.21	Euroliner N 3316	10/98->	3.70
NG 242 - SÜ 240		3.21 - 3.22	Renault Trucks		
ÜL 242, ÜL 292, Bus VÖV		3.22	Magnum	12/98->09/04	3.71
ÜL 313/353		3.23	Premium		3.71
8.103 - 12.225 (L 2000)	10/93->	3.23 - 3.24	Premium II Distribution	10/05->	3.71
7.150 - 12.240 (TGL)	04/05->	3.24	Premium II Lander	10/06->	3.72
10.136 F (G)	10/79->08/87	3.25	Premium II Route	10/05->	3.72
10.136 F, 10.150 F (G, G 90)	10/79->91	3.25	Scania		
12.163 - 18.285 (M 2000 L)	08/95->	3.25 - 3.26	Older models		3.72
12.224 - 25.285 (M 2000 M)	08/95->12/05	3.26	G 82 - T 142 (series 2)	05/80->03/88	3.72
12.136 - 48.321 (F8, F9)	01/84->	3.27 - 3.29	P 93 - T 143 (series 3)	01/88->12/96	3.73
12.192 - 24.272 (M 90)	08/88->06/96	3.30 - 3.31	P 94 - T 164 (series 4)	09/95->09/04	3.74







Manufacturer	Model year	Page
Scania		
P 230 - T 470	03/04->09/06	3.74 - 3.75
Volvo		
F 10 - F 16	08/77->	3.75 - 3.76
FH	09/08->	3.76
FH 12, FH 16	10/93->04/05	3.76 - 3.77
FL	03/00->	3.77
FL 4, FL 6	10/85->	3.78
FL 7 - FL 12	10/85->07/93	3.78
FLC	09/96->09/00	3.79
FM	06/10->	3.79
FM 7	10/98->12/01	3.79 - 3.80
FM 9	12/01->09/05	3.80
FM 12	10/98->09/05	3.80 - 3.81
FS 7		3.81

**DAF**

Manufacturer Model	Model year	Part no.	Pk.	Note
DAF				
Older models Older models		2SE 997 088-001	1	Combination rearlight with licence plate light Accessories: 2x24V10W (R10W) 2x24V21W (P21W)
		8GA 002 071-251 8GA 002 073-241	1 1	
CF 65, CF 75, CF 85 CF 65, CF 75, CF 85	01/01->	1LJ 247 046-071 1LJ 247 046-081 1LJ 247 046-051 1LJ 247 046-061	1 1 1 1	H1/H7 headlight, left, with indicator light, without headlight leveller, with bulbs H1/H7 headlight, right, with indicator light, without headlight leveller, with bulbs H1/H7 headlight, left, with indicator light, with headlight leveller and bulbs H1/H7 headlight, right, with indicator light, with headlight leveller and bulbs Spare Parts: 1x24V70W (H7) Long Life 1x24V70W (H1) 1x24V21W (P21W) 1x24V5W (W5W)
		8GH 007 157-231 8GH 002 089-251 8GA 002 073-251 8GP 003 594-251	1 1 1 1	
CF 65, CF 75, CF 85	01/01->			H1 fog light/H3 spotlight, with bulbs, only spare parts available Spare Parts: Body with headlight unit and bulbs, left, carrier frame is not part of scope of supply Body with headlight unit and bulbs, right, carrier frame is not part of scope of supply 1x24V70W (H1) 1x24V70W (H3)
		9BG 147 497-002 9BG 147 498-002 8GH 002 089-251 8GH 002 090-251	1 1 1 1	
CF 65, CF 75, CF 85	01/06->	1PE 965 410-131 1PE 965 410-141	1 1	H3 fog light/spotlight, left, with bulbs H3 fog light/spotlight, right, with bulbs Spare Parts: 2x24V70W (H3) Long Life
				
CF 65, CF 75, CF 85	01/01->	2VD 008 204-251 2VP 008 204-241	1 1	Combination rearlight, left, with licence plate, rear fog, reverse, clearance light, side-marker light, with reflex-reflector and marker reflex-reflector Combination rearlight, left/right, with rear fog, reverse, clearance light, side-marker light, with reflex-reflector and marker reflex-reflector Spare Parts: Lens with screws Accessories: 3x24V5W (R5W) 4x24V21W (P21W)
		9EL 152 889-001 8GA 002 071-241 8GA 002 073-241	1 1 1	







Manufacturer Model	Model year	Part no.	Pk.	Note
DAF				
F 2100 - F 2800 F 2100 - F 2800 F 2100, F 2200, F 2300, F 2400, F 2500 F 2800	08/85-> ->08/87	 1F6 003 939-031 8GH 002 089-251	1 1	H1 spotlight unit Accessories: 1x24V70W (H1)
F 2100 - F 2800	10/86->	 2BA 005 407-001 8GA 002 073-241	1 1	Indicator light Accessories: 1x24V21W (P21W)
LF 45, LF 55 LF 45, LF 55	01/01->	 1LJ 247 046-071 1LJ 247 046-081 1LJ 247 046-051 1LJ 247 046-061 8GH 007 157-231 8GH 002 089-251 8GA 002 073-251 8GP 003 594-251	1 1 1 1 1 1 1 1	H1/H7 headlight, left, with indicator light, without headlight leveller, with bulbs H1/H7 headlight, right, with indicator light, without headlight leveller, with bulbs H1/H7 headlight, left, with indicator light, with headlight leveller and bulbs H1/H7 headlight, right, with indicator light, with headlight leveller and bulbs Spare Parts: 1x24V70W (H7) Long Life 1x24V70W (H1) 1x24V21W (P21W) 1x24V5W (W5W)
LF 45, LF 55	01/01->	 9BG 147 497-002 9BG 147 498-002 8GH 002 089-251 8GH 002 090-251	1 1 1 1	H1 fog light/H3 spotlight, with bulbs, only spare parts available Spare Parts: Body with headlight unit and bulbs, left, carrier frame is not part of scope of supply Body with headlight unit and bulbs, right, carrier frame is not part of scope of supply 1x24V70W (H1) 1x24V70W (H3)







DAF



Manufacturer Model	Model year	Part no.	Pk.	Note
DAF				
LF 45, LF 55 LF 45, LF 55	01/01->		1PE 965 410-131 1PE 965 410-141	1 H3 fog light/spotlight, left, with bulbs 1 H3 fog light/spotlight, right, with bulbs Spare Parts: 2x24V70W (H3) Long Life
XF 95 XF 95	09/02->12/06		1LJ 247 046-071 1LJ 247 046-081 1LJ 247 046-051 1LJ 247 046-061 8GH 007 157-231 8GH 002 089-251 8GA 002 073-251 8GP 003 594-251	1 H1/H7 headlight, left, with indicator light, without headlight leveller, with bulbs 1 H1/H7 headlight, right, with indicator light, without headlight leveller, with bulbs 1 H1/H7 headlight, left, with indicator light, with headlight leveller and bulbs 1 H1/H7 headlight, right, with indicator light, with headlight leveller and bulbs Spare Parts: 1x24V70W (H7) Long Life 1x24V70W (H1) 1x24V21W (P21W) 1x24V5W (W5W)
XF 95	09/02->12/06		9BG 147 497-002 9BG 147 498-002 8GH 002 089-251 8GH 002 090-251	1 H1 fog light/H3 spotlight, with bulbs, only spare parts available Spare Parts: 1 Body with headlight unit and bulbs, left, carrier frame is not part of scope of supply 1 Body with headlight unit and bulbs, right, carrier frame is not part of scope of supply 1 1x24V70W (H1) 1 1x24V70W (H3)
XF 95	09/02->12/06		2VD 008 204-251 2VP 008 204-241 9EL 152 889-001 8GA 002 071-241 8GA 002 073-241	1 Combination rearlight, left, with licence plate, rear fog, reverse, clearance light, side-marker light, with reflex-reflector and marker reflex-reflector 1 Combination rearlight, left/right, with rear fog, reverse, clearance light, side-marker light, with reflex-reflector and marker reflex-reflector Spare Parts: 1 Lens with screws Accessories: 1 3x24V5W (R5W) 1 4x24V21W (P21W)



Manufacturer Model	Model year	Part no.	Pk.	Note
DAF				
XF 105 XF 105	10/05-> 	1LJ 247 046-071 1LJ 247 046-081 1LJ 247 046-051 1LJ 247 046-061 8GH 007 157-231 8GH 002 089-251 8GA 002 073-251 8GP 003 594-251	1 1 1 1 1 1 1 1 1	H1/H7 headlight, left, with indicator light, without headlight leveller, with bulbs H1/H7 headlight, right, with indicator light, without headlight leveller, with bulbs H1/H7 headlight, left, with indicator light, with headlight leveller and bulbs H1/H7 headlight, right, with indicator light, with headlight leveller and bulbs Spare Parts: 1x24V70W (H7) Long Life 1x24V70W (H1) 1x24V21W (P21W) 1x24V5W (W5W)
XF 105	10/05-> 	1PE 965 410-111 1PE 965 410-121	1 1	H3 fog light/spotlight, left, with bulbs H3 fog light/spotlight, right, with bulbs Spare Parts: 2x24V70W (H3) Long Life
XF 105	10/05-> 	2VD 008 204-251 2VP 008 204-241 9EL 152 889-001 8GA 002 071-241 8GA 002 073-241	1 1 1 1 1	Combination rearlight, left, with licence plate, rear fog, reverse, clearance light, side-marker light, with reflex-reflector and marker reflex-reflector Combination rearlight, left/right, with rear fog, reverse, clearance light, side-marker light, with reflex-reflector and marker reflex-reflector Spare Parts: Lens with screws Accessories: 3x24V5W (R5W) 4x24V21W (P21W)
65, 75, 85 65 75, 85	01/93->10/95 01/92->10/95 	9ES 140 721-015 9ES 140 722-015 9DE 133 697-015 9DE 133 698-015 9HD 121 297-001 8GJ 002 525-251 8GP 002 067-241	1 1 2 2 5 1 1	H4 headlight, only spare parts available Spare Parts: Lens, left Lens, right Reflector, left Reflector, right Cap 1x24V75/70W (H4) 1x24V4W (T4W)





**DAF**

Manufacturer Model	Model year	Part no.	Pk.	Note
DAF				
65, 75, 85 65, 75, 85	11/95->02/98	 1LG 007 660-031 1LG 007 660-041 9ES 147 313-011 9ES 147 314-011 9HD 121 297-001 8GJ 002 525-251 8GP 003 594-251	1 1	H4 headlight, left without electric headlight leveller, with bulbs H4 headlight, right, without electric headlight leveller, with bulbs Spare Parts: 1 Lens, left 1 Lens, right 5 Cap 1 1x24V75/70W (H4) 1 1x24V5W (W5W)
65 75, 85	01/93->02/98 01/92->02/98	 2PF 961 167-021 9EL 137 241-001 8GM 002 092-241	2 4 1	Side light Spare Parts: 4 Lens Accessories: 1 1x24V5W (C5W)
65 75, 85	01/93->02/98 01/92->02/98	 2VD 008 204-171 2VP 008 204-161 9EL 152 889-001 8GA 002 071-241 8GA 002 073-241	1 1 1 1 1	Combination rearlight, left, with licence plate, rear fog, reverse, clearance light, side-marker light, with reflex-reflector and marker reflex-reflector Combination rearlight, left/right, with rear fog, reverse, clearance light, side-marker light, with reflex-reflector and marker reflex-reflector Spare Parts: 1 Lens with screws Accessories: 1 3x24V5W (R5W) 1 4x24V21W (P21W)
65 CF, 75 CF, 85 CF 65 CF, 75 CF, 85 CF	02/98->12/00	 1LG 007 660-031 1LG 007 660-041 9ES 147 313-011 9ES 147 314-011 9HD 121 297-001 8GJ 002 525-251 8GP 003 594-251	1 1	H4 headlight, left without electric headlight leveller, with bulbs H4 headlight, right, without electric headlight leveller, with bulbs Spare Parts: 1 Lens, left 1 Lens, right 5 Cap 1 1x24V75/70W (H4) 1 1x24V5W (W5W)
65 CF, 75 CF, 85 CF	02/98->12/00	 2PF 961 167-021 9EL 137 241-001 8GM 002 092-241	2 4 1	Side light Spare Parts: 4 Lens Accessories: 1 1x24V5W (C5W)







Manufacturer Model	Model year	Part no.	Pk.	Note
DAF				
65 CF, 75 CF, 85 CF 65 CF, 75 CF, 85 CF	02/98->12/00	2VD 008 204-251 2VP 008 204-241 9EL 152 889-001 8GA 002 071-241 8GA 002 073-241	1 1 1 1 1	<p>Combination rearlight, left, with licence plate, rear fog, reverse, clearance light, side-marker light, with reflex-reflector and marker reflex-reflector</p> <p>Combination rearlight, left/right, with rear fog, reverse, clearance light, side-marker light, with reflex-reflector and marker reflex-reflector</p> <p>Spare Parts: Lens with screws</p> <p>Accessories: 3x24V5W (R5W) 4x24V21W (P21W)</p>
95 95	09/87->10/95	1LG 005 480-031 1LG 005 480-041 1LG 005 480-075 2BA 005 481-001 9ES 133 571-005 9ES 133 572-005 9DE 133 697-015 9DE 133 698-015 9HD 121 297-001 8GJ 002 525-251 8GA 002 073-241 8GP 002 067-241	1 1 1 1 4 4 2 2 5 1 1 1	<p>H4 headlight, left, with indicator light, not suitable for headlight leveller</p> <p>H4 headlight, right, with indicator light, not suitable for headlight leveller</p> <p>H4 headlight, left, with indicator light and suitable for headlight leveller</p> <p>H4 headlight, right, with indicator light and suitable for headlight leveller, only spare parts available</p> <p>Spare Parts: Indicator light with 24V bulb Lens, left Lens, right Reflector, left Reflector, right Cap 1x24V75/70W (H4) 1x24V21W (P21W) 1x24V4W (T4W)</p>
95	09/87->01/98	2BA 005 481-001 8GA 002 073-241	1 1	<p>Indicator light (amber) with 24V bulb</p> <p>Spare Parts: 1x24V21W (P21W)</p>
95	09/87->01/98	2VD 008 204-171 2VP 008 204-161 9EL 152 889-001 8GA 002 071-241 8GA 002 073-241	1 1 1 1 1	<p>Combination rearlight, left, with licence plate, rear fog, reverse, clearance light, side-marker light, with reflex-reflector and marker reflex-reflector</p> <p>Combination rearlight, left/right, with rear fog, reverse, clearance light, side-marker light, with reflex-reflector and marker reflex-reflector</p> <p>Spare Parts: Lens with screws</p> <p>Accessories: 3x24V5W (R5W) 4x24V21W (P21W)</p>



Manufacturer Model	Model year	Part no.	Pk.	Note
DAF				
95 XF 95 XF	01/97->09/02	 1LG 007 660-111 1LG 007 660-121 9ES 147 315-015 9ES 147 316-015 9HD 121 297-001 8GJ 002 525-251 8GP 003 594-251	1 1 1 5 1 1	H4 headlight, left, for vehicles with or without headlight leveller, with bulbs H4 headlight, right, for vehicles with or without headlight leveller, with bulbs Spare Parts: 1 Lens, left 1 Lens, right 5 Cap 1 1x24V75/70W (H4) 1 1x24V5W (W5W)
95 XF	01/97->09/02	 9BG 147 497-002 9BG 147 498-002 8GH 002 089-251 8GH 002 090-251	1 1 1 1	H1 fog light/H3 spotlight, with bulbs, only spare parts available Spare Parts: 1 Body with headlight unit and bulbs, left, carrier frame is not part of scope of supply 1 Body with headlight unit and bulbs, right, carrier frame is not part of scope of supply 1 1x24V70W (H1) 1 1x24V70W (H3)
95 XF	01/97->09/02	 2BA 005 481-011 8GA 002 073-241	1 1	Indicator light (white) with 24V bulb Spare Parts: 1x24V21W (P21W)
95 XF	01/97->09/02	 2VD 008 204-251 2VP 008 204-241 9EL 152 889-001 8GA 002 071-241 8GA 002 073-241	1 1 1 1 1	Combination rearlight, left, with licence plate, rear fog, reverse, clearance light, side-marker light, with reflex-reflector and marker reflex-reflector Combination rearlight, left/right, with rear fog, reverse, clearance light, side-marker light, with reflex-reflector and marker reflex-reflector Spare Parts: 1 Lens with screws Accessories: 1 3x24V5W (R5W) 1 4x24V21W (P21W)
Iveco				
EuroCargo 60 E - 320 E EuroCargo 60 E - 320 E 60 E, 65 E, 75 E, 80 E, 95 E, 100 E, 120 E, 130 E, 135 E, 150 E, 170 E, 180 E, 260 E, 280 E, 320 E	01/91->	 2VD 008 204-191 2VP 008 204-181 9EL 152 889-001 8GA 002 071-241 8GA 002 073-241	1 1 1 1 1	Combination rearlight, left, with licence plate, rear fog, reverse, clearance light, side-marker light, with reflex-reflector and marker reflex-reflector Combination rearlight, left/right, with rear fog, reverse, clearance light, side-marker light, with reflex-reflector and marker reflex-reflector Spare Parts: 1 Lens with screws Accessories: 1 3x24V5W (R5W) 1 4x24V21W (P21W)





Manufacturer Model	Model year	Part no.	Pk.	Note
Iveco				
EuroStar LD 190 - LD 440 EuroStar LD 190 - LD 440 LD 190, LD 240, LD 260 LD 400, LD 440 	01/93->	2VD 008 204-191	1	Combination rearlight, left, with licence plate, rear fog, reverse, clearance light, side-marker light, with reflex-reflector and marker reflex-reflector
		2VP 008 204-181	1	Combination rearlight, left/right, with rear fog, reverse, clearance light, side-marker light, with reflex-reflector and marker reflex-reflector
		9EL 152 889-001	1	Spare Parts: Lens with screws
		8GA 002 071-241 8GA 002 073-241	1 1	Accessories: 3x24V5W (R5W) 4x24V21W (P21W)
EuroTech MH 180 - MT 400 EuroTech MH 180 - MT 400 MH 180, MH 190, MH 260, MH 400 MP 180, MP 190, MP 240, MP 400, MP 440 MT 180, MT 190, MT 400 	01/92->	2VD 008 204-191	1	Combination rearlight, left, with licence plate, rear fog, reverse, clearance light, side-marker light, with reflex-reflector and marker reflex-reflector
	09/98->	2VP 008 204-181	1	Combination rearlight, left/right, with rear fog, reverse, clearance light, side-marker light, with reflex-reflector and marker reflex-reflector
	01/92->	9EL 152 889-001	1	Spare Parts: Lens with screws
	01/92->	8GA 002 071-241 8GA 002 073-241	1 1	Accessories: 3x24V5W (R5W) 4x24V21W (P21W)
EuroTrakker MP 190 - MP 410 EuroTrakker MP 190 - MP 410 MP 190, MP 260, MP 340, MP 380, MP 410 	01/93->	2VD 008 204-191	1	Combination rearlight, left, with licence plate, rear fog, reverse, clearance light, side-marker light, with reflex-reflector and marker reflex-reflector
		2VP 008 204-181	1	Combination rearlight, left/right, with rear fog, reverse, clearance light, side-marker light, with reflex-reflector and marker reflex-reflector
		9EL 152 889-001	1	Spare Parts: Lens with screws
		8GA 002 071-241 8GA 002 073-241	1 1	Accessories: 3x24V5W (R5W) 4x24V21W (P21W)
Stralis Stralis 	02/02->	2VD 008 204-191	1	Combination rearlight, left, with licence plate, rear fog, reverse, clearance light, side-marker light, with reflex-reflector and marker reflex-reflector
		2VP 008 204-181	1	Combination rearlight, left/right, with rear fog, reverse, clearance light, side-marker light, with reflex-reflector and marker reflex-reflector
		9EL 152 889-001	1	Spare Parts: Lens with screws
		8GA 002 071-241 8GA 002 073-241	1 1	Accessories: 3x24V5W (R5W) 4x24V21W (P21W)



Iveco Ford - Iveco Magirus

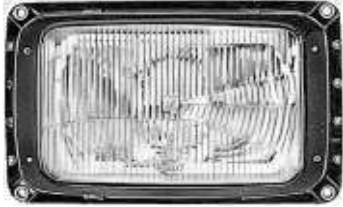



Manufacturer Model	Model year	Part no.	Pk.	Note
Iveco Ford				
190 - 210		1LG 003 434-187	4	H4 headlight
190 - 210		9ES 122 221-007	7	Spare Parts: Lens Reflector 1x24V75/70W (H4) 1x24V4W (T4W)
		9DE 131 520-017	2	
		8GJ 002 525-251	1	
		8GP 002 067-241	1	
				
Iveco Magirus				
75-9 A - 160 M13 FS		2BA 003 022-001	1	Indicator light, with lead
75-9 A - 160 M13 FS (MK-series)	09/75->	2BA 003 022-021	1	Indicator light, without lead
		9EL 116 907-001	1	Spare Parts: Lens Bulb holder
		9FT 117 109-007	1	
		8GA 002 073-121	1	Accessories: 1x12V21W (P21W) 1x24V21W (P21W)
		8GA 002 073-241	1	
				



Manufacturer Model	Model year	Part no.	Pk.	Note
Iveco Magirus				
75-9 A - 160 M13 FS		2SE 002 578-701	2	Combination rearlight with licence plate light
80-13 A - 160 M13 FS (MK-series)	09/75->			Spare Parts: Body/lens with screws
80-13 A, AT	01/83->07/84	9EL 146 491-001	2	
80-13 AH	01/83->	8GA 002 071-131	1	Accessories: 1x12V10W (R10W)
80-16 A	01/83->07/84	8GA 002 071-251	1	1x24V10W (R10W)
90 M7 FK, FL, 90 M8 FK, FL, FS, 90 M9 FL	09/75->12/82	8GA 002 073-121	1	2x12V21W (P21W)
90-13 A, AT	01/83->07/84	8GA 002 073-241	1	2x24V21W (P21W)
90-13 AH	01/83->			
110-13 A	01/83->07/84			
110-13 AH	01/83->			
110-16 A, AT	01/83->07/84			
110-16 AH	01/83->			
130 M8 FK, FL, FS, 130 M9 FK, FL, FS, 130 M11 FK, FL, 130 M13 FK, FL	09/75->12/82			
130-13 A	01/83->07/84			
130-13 AH	01/83->			
130-16 A, AT	01/83->07/84			
130-16 AH	01/83->			
160 M11 FK, FL, FS, 160 M13 FK, FL, FS	09/75->12/82			



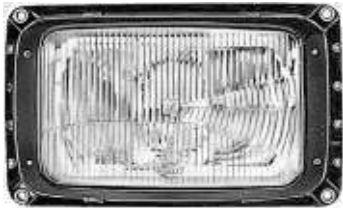



Manufacturer Model	Model year	Part no.	Pk.	Note
Iveco Magirus				
120-13 ANW - 330-30 ANW				
120-13 ANW - 330-30 ANW (P/PA-Cab-behind-engine vehicles)	01/83->	1LG 003 434-187	4	H4 headlight
		9ES 122 221-007	7	Spare Parts: Lens
		9DE 131 520-017	2	Reflector
120-13 ANW 120-16 ANW 150-16 AN, ANW 160-23 ANW 190-25 AN, ANW, ANT	01/83->	8GJ 002 525-251	1	Accessories: 1x24V75/70W (H4)
		8GP 002 067-241	1	1x24V4W (T4W)
190-30 N, NT	05/86->			
260-25 AN, ANW	01/83->			
330-30 AN, ANW	05/86->			
				
120-13 ANW - 330-30 ANW (P/PA-Cab-behind-engine vehicles)	01/83->	2BA 003 022-001 2BA 003 022-021	1 1	Indicator light, with lead Indicator light, without lead
		9EL 116 907-001	1	Spare Parts: Lens
		9FT 117 109-007	1	Bulb holder
		8GA 002 073-241	1	Accessories: 1x24V21W (P21W)
				
120-13 ANW - 330-30 ANW (P/PA-Cab-behind-engine vehicles)	01/83->	2SE 001 699-071 2SD 001 699-061	1 1	Combination rearlight, left, with licence plate light Combination rearlight, right, without licence plate light
120-13 ANW 120-16 ANW 150-16 AN, ANW 160-23 ANW 190-25 AN, ANT, ANW	01/83->	9EL 109 139-001	2	Spare Parts: Lens with screws
		9GT 074 132-001	10	Grommet
190-30 N, NT	05/86->	8GA 002 071-251	1	Accessories: 1x24V10W (R10W)
260-25 AN, ANW	01/83->	8GA 002 073-241	1	2x24V21W (P21W)
330-30 AN, ANW	05/86->			
				



Manufacturer Model	Model year	Part no.	Pk.	Note
Iveco Magirus				
120-13 ANW - 330-30 ANW				
120-13 ANW - 330-30 ANW (P/PA-Cab-behind-engine vehicles)	01/83->	2SE 003 167-031	1	Combination rearlight, left, with licence plate light
		2SD 003 167-021	1	Combination rearlight, right, without licence plate light
120-13 ANW	01/83->	9EL 147 747-001	1	Spare Parts: Lens with screws
120-16 ANW		9GD 087 883-355	10	Seal
150-16 AN, ANW				
160-23 ANW				
190-25 AN, ANT, ANW		8GA 002 071-251	1	Accessories: 1x24V10W (R10W)
		8GA 002 073-241	1	2x24V21W (P21W)
190-30 N, NT	05/86->			
260-25 AN, ANW	01/83->			
330-30 AN, ANW	05/86->			
120-13 ANW - 330-30 ANW (P/PA-Cab-behind-engine vehicles)	01/83->	2JA 001 357-002	6	Interior light with switch
		2JA 001 357-012	6	Interior light without switch
		8GM 002 091-251	1	Accessories: 1x24V10W (K)
130 D - 310 D (P/PA-series)				
130 D - 310 D (P/PA-series)	01/71->12/82	1LG 003 434-187	4	H4 headlight
130 D 12 AK		9ES 122 221-007	7	Spare Parts: Lens
130 D 15 K, AK		9DE 131 520-017	2	Reflector
160 D 12 AK				
160 D 15 K, AK				
170 D 12 AK				
170 D 15 K, AK				
230 D 16 AK		8GJ 002 525-251	1	Accessories: 1x24V75/70W (H4)
230 D 22 AK		8GP 002 067-241	1	1x24V4W (T4W)
230 D 26 AK				
232 D 16 AK				
232 D 26 K, AK				
256 D 16 K, AK				
256 D 26 K, AK				
270 D 16 K, AK, S				
310 D 16 K, AK, S				
310 D 26 K, AK, AS				





Manufacturer Model	Model year	Part no.	Pk.	Note
Iveco Magirus				
130 D - 310 D (P/PA-series)		2BA 003 022-001	1	Indicator light, with lead
130 D - 310 D (P/PA-series)	01/71->12/82	2BA 003 022-021	1	Indicator light, without lead
		9EL 116 907-001	1	Spare Parts: Lens
		9FT 117 109-007	1	Bulb holder
		8GA 002 073-241	1	Accessories: 1x24V21W (P21W)
				
130 D - 310 D (P/PA-series)	01/71->12/82	2SE 001 699-071	1	Combination rearlight, left, with licence plate light
130 D 12 AK		2SD 001 699-061	1	Combination rearlight, right, without licence plate light
130 D 15 AK, K		9EL 109 139-001	2	Spare Parts: Lens with screws
160 D 12 AK		9GT 074 132-001	10	Grommet
160 D 15 AK, K		8GA 002 071-251	1	Accessories: 1x24V10W (R10W)
170 D 12 AK		8GA 002 073-241	1	2x24V21W (P21W)
170 D 15 AK, K				
230 D 16 AK				
230 D 22 AK				
230 D 26 AK				
232 D 16 AK				
232 D 26 AK, K				
256 D 16 AK, K				
256 D 26 AK, K				
270 D 16 AK, K, S				
310 D 16 AK, K, S				
310 D 26 AK, AS, K				
				





Manufacturer Model	Model year	Part no.	Pk.	Note
Iveco Magirus				
130 D - 310 D (P/PA-series)		2SE 003 167-031	1	Combination rearlight, left, with licence plate light
130 D - 310 D (P/PA-series)	01/71->12/82	2SD 003 167-021	1	Combination rearlight, right, without licence plate light
130 D 12 AK		9EL 147 747-001	1	Spare Parts: Lens with screws
130 D 15 AK, K		9GD 087 883-355	10	Seal
160 D 12 AK				
160 D 15 AK, K				
170 D 12 AK				
170 D 15 AK, K		8GA 002 071-251	1	Accessories: 1x24V10W (R10W)
230 D 16 AK		8GA 002 073-241	1	2x24V21W (P21W)
230 D 22 AK				
230 D 26 AK				
232 D 16 AK				
232 D 26 AK, K				
256 D 16 AK, K				
256 D 26 AK, K				
270 D 16 AK, K, S				
310 D 16 AK, K, S				
310 D 26 AK, AS, K				
130 D - 310 D (P/PA-series)	01/71->12/82	2JA 001 357-002	6	Interior light with switch
		2JA 001 357-012	6	Interior light without switch
		8GM 002 091-251	1	Accessories: 1x24V10W (K)
130 D 9 FL - 340 D 22		2BA 003 022-001	1	Indicator light, with lead
130 D 9 FL - 340 D 22 (Forward-control vehicles)	05/73->	2BA 003 022-021	1	Indicator light, without lead
		9EL 116 907-001	1	Spare Parts: Lens
		9FT 117 109-007	1	Bulb holder
		8GA 002 073-241	1	Accessories: 1x24V21W (P21W)



Manufacturer Model	Model year	Part no.	Pk.	Note
Iveco Magirus				
130 D 9 FL - 340 D 22		2SD 001 699-061	1	Combination rearlight
130 D 9 FL - 340 D 22 (Forward-control vehicles)	05/73->	9EL 109 139-001 9GT 074 132-001	2 10	Spare Parts: Lens with screws Grommet
130 D 9 FL, 130 D 11 FL, 130 D 14 FL, 130 D 16 FL, FLL, 160 D 11 FL	01/75->	8GA 002 071-251 8GA 002 073-241	1 1	Accessories: 1x24V10W (R10W) 2x24V21W (P21W)
160 D 16 FL	05/73->			
170 D 11 FL	01/75->			
170 D 14 FL, FS, 170 D 15 FAK, FK	05/73->			
170 D 16 FL, 170 D 19 FL, 232 D 13 FL	01/75->			
232 D 15 FAK, FK, FLL, 232 D 15,5 FL, FLL, FS	05/73->			
232 D 16 FL, 232 D 19 FAK, FK, FL, 232 D 22 FAK, FK, FL, 256 D 16 FL, 256 D 22 FLL, 270 D 16 FK, FL, FLL, 270 D 22 FAK, FL, FLL, 270 D 26 FAK	01/75->			
310 D 16 FS, FSL, 310 D 16 FAK, FK	05/73->			
310 D 16 FL, FLL, 310 D 19 FL, FS	01/75->			
310 D 22 FAK, FSL	05/73->			
310 D 22 FL, FLL, FS	01/75->			
310 D 26 FK	05/73->			
340 D 16 FL, FLL, 340 D 22 FL, FLL	01/75->			
				
130 D 9 FL - 340 D 22 (Forward-control vehicles)	05/73->	2KA 001 386-231	2	Licence plate light
		9BG 101 230-001 9GT 005 166-001	2 10	Spare Parts: Body with lens Grommet
		8GM 002 092-121	1	Accessories: 1x12V5W (C5W)
				







Manufacturer Model	Model year	Part no.	Pk.	Note
Iveco Magirus				
180-24 - 320 M (T-series)		1LG 003 434-187	4	H4 headlight
180-24 - 240-38, 256 M - 320 M (T-series)		9ES 122 221-007 9DE 131 520-017	7 2	Spare Parts: Lens Reflector
180-24, T, 190-26, T 190-30, P, T, PT 190-33, P, T, PT 190-36, P, T 190-39, P, T, PT 190-42, P, T, PT 220-30 PT, 220-36 PT 220-38 PT, 240-30 P 240-36 P, 240-38 P	09/85->	8GJ 002 525-251 8GP 002 067-241	1 1	Accessories: 1x24V75/70W (H4) 1x24V4W (T4W)
256 M 19 FK, FAK, FKS-FF 256 M 26 FK, FAK, FKS-FF 320 M 19 FK, FAK, FKS-FF 320 M 26 FK, FAK, FKS-FF	05/78->			
				
180-24 - 240-38, 256 M - 320 M (T-series)		2SE 003 167-031	1	Combination rearlight, left, with licence plate light
		2SD 003 167-021	1	Combination rearlight, right, without licence plate light
180-24, T, 190-26, T 190-30, P, T, PT 190-33, P, T, PT 190-36, P, T 190-38, P, T, PT 190-42, P, T, PT 220-30 PT, 220-36 PT 220-38 PT, 240-30 P 240-36 P, 240-38 P	09/85->	9EL 147 747-001 9GD 087 883-355	1 10	Spare Parts: Lens with screws Seal
256 M 19 FAK, FK, FKS-FF 256 M 26 FAK, FK, FKS-FF 320 M 19 FAK, FK, FKS-FF 320 M 26 FAK, FK, FKS-FF	05/78->	8GA 002 071-251 8GA 002 073-241	1 1	Accessories: 1x24V10W (R10W) 2x24V21W (P21W)
				





Iveco Magirus - MAN





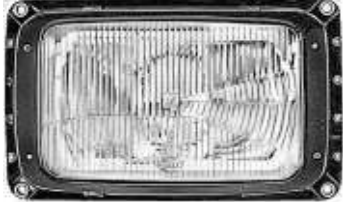

Manufacturer Model	Model year	Part no.	Pk.	Note
Iveco Magirus				
180-24 - 320 M (T-series) 180-24 - 240-38, 256 M - 320 M (T-series)	05/78->	2NE 003 236-001 9EL 119 544-001 9DX 119 545-011 8GA 002 073-241	1 4 2 1	Rear fog light Spare Parts: Lens Reflector Accessories: 1x24V21W (P21W)
				
180-24 - 240-38, 256 M - 320 M (T-series)	05/78->	2ZR 003 236-051 9EL 119 544-111 9DX 119 545-051 8GA 002 073-241	1 4 2 1	Reverse light Spare Parts: Lens Reflector Accessories: 1x24V21W (P21W)
				
MAN				
EL 202 EL 202		1LG 003 434-237 9ES 122 221-007 9HD 121 297-035 8GJ 002 525-251 8GP 002 067-241	1 7 70 1 1	H4 headlight, suitable for headlight leveller Spare Parts: Lens Cap Accessories: 1x24V75/70W (H4) 1x24V4W (T4W)
				
EL 202		2SD 003 167-531 2SD 003 167-541 9EL 147 747-001 9GD 087 883-355 8GA 002 071-251 8GA 002 073-241	1 1 1 10 1 1	Combination rearlight, left Combination rearlight, right Spare Parts: Lens with screws Seal Accessories: 1x24V10W (R10W) 2x24V21W (P21W)
				
EL 202		2KA 003 389-081 9BG 121 587-031 8GA 002 071-251	1 2 1	Licence plate light Spare Parts: Body/lens with screw Accessories: 1x24V10W (R10W)
				





Manufacturer Model	Model year	Part no.	Pk.	Note
MAN				
Lion's Family Lion's Family Lion's Comfort Lion's Star FRH 422		1FE 005 478-011 1FE 005 478-021 8GH 002 089-251	1 1 1	H1 spotlight unit, left H1 spotlight unit, right Accessories: 1x24V70W (H1)
				
Lion's Family Lion's Coach FRH 353 Lion's Comfort Lion's Star FRH 422		2BA 005 603-001 8GA 002 073-241	1 1	Indicator light, for front mounting Accessories: 1x24V21W (P21W)
				
Lion's Family Lion's Coach FRH 353 Lion's Comfort Lion's Star FRH 422		2KA 001 388-051 8GM 002 092-241	1 1	Licence plate light Accessories: 1x24V5W (C5W)
				
NG 242 - SÜ 240 NG 242 - SL 202 NG 242, NG 272 NL 202, NM 152 SG 242, SG 292 SL 202	07/90-> 05/91-> 03/88->	1LG 003 434-237 9ES 122 221-007 9HD 121 297-035 8GJ 002 525-251 8GP 002 067-241	1 7 70 1 1	H4 headlight, suitable for headlight leveller Spare Parts: Lens Cap Accessories: 1x24V75/70W (H4) 1x24V4W (T4W)
				





**MAN**

Manufacturer Model	Model year	Part no.	Pk.	Note
MAN				
NG 242 - SÜ 240 SG 242 - SL 202 SG 242, SG 292, SL 202		1NB 003 367-137 8GH 002 090-251	36 1	H3 fog light Accessories: 1x24V70W (H3)
				
NG 242 - SÜ 240 NG 242, NG 272, NL 202, NM 152, SG 242, SG 292 SL 200, SL 202, SÜ 240	07/82->	2SD 003 167-531 2SD 003 167-541 9EL 147 747-001 9GD 087 883-355 8GA 002 071-251 8GA 002 073-241	1 1 1 10 1 1	Combination rearlight, left Combination rearlight, right Spare Parts: Lens with screws Seal Accessories: 1x24V10W (R10W) 2x24V21W (P21W)
				
NG 242 - SL 202 NG 242, NG 272 SG 242, SG 292, SL 202	09/91->	2KA 003 010-007 8GA 002 071-241	1 1	Licence plate light Accessories: 2x24V5W (R5W)
				
SG 242 - SL 202 SG 242, SG 292 SL 202	02/86->	2KA 003 389-081 9BG 121 587-031 8GA 002 071-251	1 2 1	Licence plate light Spare Parts: Body/lens with screw Accessories: 1x24V10W (R10W)
				
ÜL 242, ÜL 292, Bus VÖV ÜL 242, ÜL 292 Bus VÖV		1NB 003 367-137 8GH 002 090-251	36 1	H3 fog light Accessories: 1x24V70W (H3)
				





Manufacturer Model	Model year	Part no.	Pk.	Note
MAN				
ÜL 313/353 ÜL 313/353 		1FE 005 478-011 1FE 005 478-021 8GH 002 089-251	1 1 1	H1 spotlight unit, left H1 spotlight unit, right Accessories: 1x24V70W (H1)
ÜL 313/353 		2BA 005 603-001 8GA 002 073-241	1 1	Indicator light, for front mounting Accessories: 1x24V21W (P21W)
ÜL 313/353 		2KA 001 388-051 8GM 002 092-241	1 1	Licence plate light Accessories: 1x24V5W (C5W)
8.103 - 12.225 (L 2000) 8.103 - 12.225 (L 2000-series) 10/93->		2BA 007 839-001 8GA 002 073-241	1 1	Indicator light Accessories: 1x24V21W (P21W)
8.103 - 12.225 (L 2000-series) 10/93->		2BM 006 692-011 2BM 006 692-021 8GA 002 073-241	1 1 1	Auxiliary indicator light, left Auxiliary indicator light, right Accessories: 1x24V21W (P21W)

**MAN**

Manufacturer Model	Model year	Part no.	Pk.	Note
MAN				
8.103 - 12.225 (L 2000)		2VD 008 204-051	1	Combination rearlight, left, with licence plate, rear fog, reverse and clearance light, with reflex-reflector and centre plug
8.103 - 12.225 (L 2000-series)	10/93->08/00			
8.103, 8.113, 8.145, 8.150, 8.153, 8.163, 8.185, 8.220, 8.223, 8.224, 8.225		2VP 008 204-041	1	Combination rearlight, left/right, with rear fog, reverse and clearance light, with reflex-reflector and centre plug
9.145, 9.153, 9.163, 9.185, 9.223, 9.224, 9.225		2VD 008 204-071	1	Combination rearlight, left, with licence plate, rear fog, reverse, clearance light, side-marker light, with reflex-reflector, marker reflex-reflector and centre plug
10.145, 10.150, 10.153, 10.163, 10.185, 10.220, 10.223, 10.224, 10.225		2VP 008 204-061	1	Combination rearlight, left/right, with rear fog, reverse, clearance light, side-marker light, with reflex-reflector, marker reflex-reflector and centre plug
12.185, 12.225				
		9EL 152 889-001	1	Spare Parts: Lens with screws
		8GA 002 071-241	1	Accessories: 3x24V5W (R5W)
		8GA 002 073-241	1	4x24V21W (P21W)
8.103 - 12.225 (L 2000-series)	10/03->	2XS 005 020-041	10	Clearance light (red)
		9EL 132 215-011	2	Spare Parts: Body/lens with screws
		8GP 002 067-241	1	Accessories: 1x24V4W (T4W)
				
7.150 - 12.240 (TGL)		2KA 003 389-081	1	Licence plate light
7.150 - 12.240 (TGL)	04/05->			
		9BG 121 587-031	2	Spare Parts: Body/lens with screw
		8GA 002 071-251	1	Accessories: 1x24V10W (R10W)
				
7.150 - 12.240 (TGL)	04/05->	2XS 005 020-041	10	Clearance light (red)
		9EL 132 215-011	2	Spare Parts: Body/lens with screws
		8GP 002 067-241	1	Accessories: 1x24V4W (T4W)
				



Manufacturer Model	Model year	Part no.	Pk.	Note
MAN				
10.136 F (G)		1L8 003 060-561	1	Headlight
10.136 F (G-series)	10/79->08/87	9GH 116 966-011 9FF 126 444-001 8GD 002 088-251 8GP 002 067-241	10 10 1 1	Spare Parts: Cap Bulb socket for side light 1x24V55/50W (R2) 1x24V4W (T4W)
		1L8 003 060-691	1	H4 headlight
		9GH 116 966-011 9FF 126 444-001 8GJ 002 525-251 8GP 002 067-241	10 10 1 1	Spare Parts: Cap Accessories: Bulb socket for side light Spare Parts: 1x24V75/70W (H4) 1x24V4W (T4W)
10.136 F, 10.150 F (G, G 90)				Combination rearlight available as separate parts only as follows (modular system).
10.136 F, 10.150 F (G, G 90-series)	10/79->91	9BG 130 945-001 9BG 130 946-001	2 2	Body with central plug, left Body with central plug, right
10.136 F	10/79->08/87			(The existing licence plate window in the body should be closed if not required with cover 9HB 126 601-001)
10.150 F	09/87->91			Suitable lenses:
		9EL 122 689-051 9EL 122 689-021	2 2	Lens for rear, reflex-reflector, stop, indicator and reverse light Lens for rear, reflex-reflector, stop, indicator, reverse-rear fog light
		9HB 126 601-001 9GP 003 995-801	2 1	Accessories: Cover for licence plate window Vibration damper set
		8GA 002 071-251 8GA 002 073-241	1 1	Accessories: 1x24V10W (R10W) 4x24V21W (P21W)
12.163 - 18.285 (M 2000 L)		2BA 007 839-001	1	Indicator light
12.163 - 18.285 (M 2000 L-series) with compact cab	08/95->	8GA 002 073-241	1	Accessories: 1x24V21W (P21W)
				





MAN



Manufacturer Model	Model year	Part no.	Pk.	Note
MAN				
12.163 - 18.285 (M 2000 L)		2VD 008 204-051	1	Combination rearlight, left, with licence plate, rear fog, reverse and clearance light, with reflex-reflector and centre plug
12.163 - 18.284 (M 2000 L-series)	08/95->			
12.163, 12.224		2VP 008 204-041	1	Combination rearlight, left/right, with rear fog, reverse and clearance light, with reflex-reflector and centre plug
14.163, 14.224, 14.264, 14.284		2VD 008 204-071	1	Combination rearlight, left, with licence plate, rear fog, reverse, clearance light, side-marker light, with reflex-reflector, marker reflex-reflector and centre plug
15.163, 15.224, 15.264, 15.284				
18.224, 18.264, 18.284		2VP 008 204-061	1	Combination rearlight, left/right, with rear fog, reverse, clearance light, side-marker light, with reflex-reflector, marker reflex-reflector and centre plug
		9EL 152 889-001	1	Spare Parts: Lens with screws
		8GA 002 071-241	1	Accessories: 3x24V5W (R5W)
		8GA 002 073-241	1	4x24V21W (P21W)
12.224 - 25.285 (M 2000 M)		2VD 008 204-051	1	Combination rearlight, left, with licence plate, rear fog, reverse and clearance light, with reflex-reflector and centre plug
12.224 - 25.285 (M 2000-series)	08/95->12/05			
12.224, 12.255, 12.264, 12.284		2VP 008 204-041	1	Combination rearlight, left/right, with rear fog, reverse and clearance light, with reflex-reflector and centre plug
14.224, 14.225, 14.255, 14.264, 14.284, 14.285		2VD 008 204-071	1	Combination rearlight, left, with licence plate, rear fog, reverse, clearance light, side-marker light, with reflex-reflector, marker reflex-reflector and centre plug
18.224, 18.225, 18.255, 18.264, 18.284, 18.285				
25.224, 25.225, 25.255, 25.264, 25.285		2VP 008 204-061	1	Combination rearlight, left/right, with rear fog, reverse, clearance light, side-marker light, with reflex-reflector, marker reflex-reflector and centre plug
		9EL 152 889-001	1	Spare Parts: Lens with screws
		8GA 002 071-241	1	Accessories: 3x24V5W (R5W)
		8GA 002 073-241	1	4x24V21W (P21W)

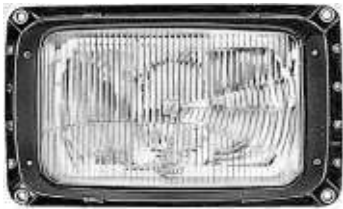

Manufacturer Model	Model year	Part no.	Pk.	Note
MAN				
12.136 - 48.321 (F8, F9) 12.136 - 48.321 (F8, F9-series) 12.136, 12.170, 12.192 14.170, 14.192, 14.220 15.168, 15.192, 15.220, 15.240 16.136, 16.168, 16.170, 16.192, 16.220, 16.240 17.136, 17.170, 17.192, 17.220, 17.240 19.240, 19.281, 19.291, 19.321, 19.331, 19.361 20.281, 20.321, 20.361 22.192, 22.220, 22.240, 22.281, 22.291, 22.321, 22.331, 22.361 26.240, 26.281, 26.291, 26.321, 26.331, 26.361, 26.365 30.281, 30.291, 30.321, 30.331 32.240, 32.281, 32.291, 32.321, 32.331, 32.361, 32.365 40.440, 40.365, 40.400 48.321		1LG 003 434-237 9ES 122 221-007 9HD 121 297-035 8GJ 002 525-251 8GP 002 067-241	1 7 70 1 1	H4 headlight, suitable for headlight leveller Spare Parts: Lens Cap 1x24V75/70W (H4) 1x24V4W (T4W)
				
12.136 - 48.321 (F8, F9-series)		9DF 112 246-001 8GH 002 090-251	1 1	H3 fog light, only spare parts available Spare Parts: Reflector with lens 1x24V70W (H3)
				





MAN







Manufacturer Model	Model year	Part no.	Pk.	Note
MAN				
12.136 - 48.321 (F8, F9)		2VP 003 567-111	1	Combination rearlight, left, with reverse and rear fog light
12.136 - 48.321 (F8, F9-series)	->12/83	2VP 003 567-121	1	Combination rearlight, right, with reverse and rear fog light
12.136, 12.170, 12.192				Spare Parts:
14.170, 14.192, 14.220		9EL 122 689-021	2	Lens with screws
15.168, 15.192, 15.220, 15.240		9GT 074 132-001	10	Accessories: Grommet
16.136, 16.168, 16.170, 16.192, 16.220, 16.240		9GP 003 995-801	1	Vibration damper set
17.136, 17.170, 17.192, 17.220, 17.240		8GA 002 071-251	1	1x24V10W (R10W)
19.240, 19.281, 19.291, 19.321, 19.331, 19.361		8GA 002 073-241	1	4x24V21W (P21W)
20.281, 20.321, 20.361				
22.192, 22.220, 22.240, 22.281, 22.291, 22.321, 22.331, 22.361				
26.240, 26.281, 26.291, 26.321, 26.331, 26.361, 26.365				
30.281, 30.291, 30.321, 30.331				
32.240, 32.281, 32.291, 32.321, 32.331, 32.361, 32.365				
40.365, 40.400, 48.321				
48.321				









Manufacturer Model	Model year	Part no.	Pk.	Note
MAN				
12.136 - 48.321 (F8, F9)				Combination rearlight available as separate parts only as follows (modular system).
12.136 - 48.321 (F8, F9-series)	01/84->			
12.136, 12.170, 12.192		9BG 130 945-001	2	Body with central plug, left
14.170, 14.192, 14.220		9BG 130 946-001	2	Body with central plug, right (The existing licence plate window in the body should be closed if not required with cover 9HB 126 601-001)
15.168, 15.192, 15.220, 15.240				Suitable lenses:
16.136, 16.168, 16.170, 16.192, 16.220, 16.240		9EL 122 689-051	2	Lens for rear, reflex-reflector, stop, indicator and reverse light
17.136, 17.170, 17.192, 17.220, 17.240		9EL 122 689-021	2	Lens for rear, reflex-reflector, stop, indicator, reverse-rear fog light
19.240, 19.281, 19.291, 19.321, 19.331, 19.361				Accessories:
20.281, 20.321, 20.361		9HB 126 601-001	2	Cover for licence plate window
22.192, 22.220, 22.240, 22.281, 22.291, 22.321, 22.331, 22.361		9GP 003 995-801	1	Vibration damper set
26.240, 26.281, 26.291, 26.321, 26.331, 26.361, 26.365		8GA 002 071-251	1	1x24V10W (R10W)
30.281, 30.291, 30.321, 30.331		8GA 002 073-241	1	4x24V21W (P21W)
32.240, 32.281, 32.291, 32.321, 32.331, 32.361, 32.365				
40.365, 40.400, 48.321				
48.321				
				
12.136 - 48.321 (F8, F9-series)		2KA 003 389-081	1	Licence plate light
		9BG 121 587-031	2	Spare Parts: Body/lens with screw
		8GA 002 071-251	1	Accessories: 1x24V10W (R10W)
				

**MAN**

Manufacturer Model	Model year	Part no.	Pk.	Note
MAN				
12.192 - 24.272 (M 90)		1LG 003 434-237	1	H4 headlight, suitable for headlight leveller
12.192 - 24.272 (M 90-series)	08/88->06/96			Spare Parts:
12.192, 12.222, 12.232, 12.262, 12.272		9ES 122 221-007	7	Lens
		9HD 121 297-035	70	Cap
14.152, 14.162, 14.192, 14.222, 14.232, 14.262, 14.272		8GJ 002 525-251	1	Accessories: 1x24V75/70W (H4)
		8GP 002 067-241	1	1x24V4W (T4W)
17.192, 17.232, 17.272				
18.192, 18.222, 18.232, 18.262, 18.272				
24.192, 24.222, 24.232, 24.262, 24.272				
				
12.192 - 24.272 (M 90-series)	08/88->09/90			H3 fog light, only spare parts available
		9DF 112 246-001	1	Spare Parts: Reflector with lens
		8GH 002 090-251	1	Accessories: 1x24V70W (H3)
12.192 - 24.272 (M 90-series)	10/90->04/93			H3 fog light
		1NE 138 555-011	1	Spare Parts: Light unit
		8GH 002 090-251	1	Accessories: 1x24V70W (H3)
12.192 - 24.272 (M 90-series)	05/93->06/96			H3 fog light
		1NE 138 555-011	1	Spare Parts: Light unit
		8GH 002 090-251	1	Accessories: 1x24V70W (H3)





Manufacturer Model	Model year	Part no.	Pk.	Note
MAN				
12.192 - 24.272 (M 90)		2BA 007 840-001	1	Indicator light
12.192 - 24.272 (M 90-series)	08/88->06/96	8GA 002 073-241	1	Accessories: 1x24V21W (P21W)
				
12.192 - 24.272 (M 90-series)	08/88->91			Combination rearlight available as separate parts only as follows (modular system).
12.192, 12.222, 12.232, 12.262, 12.272		9BG 130 945-001	2	Body with central plug, left
14.152, 14.162, 14.192, 14.222, 14.232, 14.262, 14.272		9BG 130 946-001	2	Body with central plug, right (The existing licence plate window in the body should be closed if not required with cover 9HB 126 601-001)
17.192, 17.232, 17.272				Suitable lenses:
18.192, 18.222, 18.232, 18.262, 18.272		9EL 122 689-051	2	Lens for rear, reflex-reflector, stop, indicator and reverse light
24.192, 24.232, 24.272		9EL 122 689-021	2	Lens for rear, reflex-reflector, stop, indicator, reverse-rear fog light
		9HB 126 601-001	2	Cover for licence plate window
		9GP 003 995-801	1	Vibration damper set
		8GA 002 071-251	1	1x24V10W (R10W)
		8GA 002 073-241	1	4x24V21W (P21W)
12.192 - 24.272 (M 90-series)	08/88->91	2KA 003 389-081	1	Licence plate light
		9BG 121 587-031	2	Spare Parts: Body/lens with screw
		8GA 002 071-251	1	Accessories: 1x24V10W (R10W)
				
12.192 - 24.272 (M 90-series)	08/88->06/96	2XS 005 020-041	10	Clearance light (red)
		9EL 132 215-011	2	Spare Parts: Body/lens with screws
		8GP 002 067-241	1	Accessories: 1x24V4W (T4W)
				



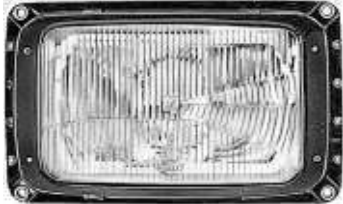

MAN



Manufacturer Model	Model year	Part no.	Pk.	Note
MAN				
19.242 - 48.462 (F 90)		1LG 003 434-237	1	H4 headlight, suitable for headlight leveller
19.242 - 48.462 (F 90-series)	06/86->			Spare Parts:
19.242, 19.262, 19.272, 19.292, 19.322, 19.332, 19.342, 19.362, 19.372, 19.402, 19.422, 19.462, 19.502		9ES 122 221-007	7	Lens
		9HD 121 297-035	70	Cap
24.242, 24.262, 24.272, 24.292, 24.302, 24.322, 24.332, 24.342, 24.362, 24.372, 24.402, 24.422, 24.462, 24.502				Accessories:
25.272, 25.302, 25.322, 25.372, 25.422, 25.502		8GJ 002 525-251	1	1x24V75/70W (H4)
26.242, 26.262, 26.272, 26.292, 26.302, 26.322, 26.332, 26.342, 26.362, 26.372, 26.402, 26.422, 26.462, 26.502		8GP 002 067-241	1	1x24V4W (T4W)
32.262, 32.272, 32.292, 32.302, 32.322, 32.332, 32.342, 32.362, 32.372, 32.402, 32.422				
33.242, 33.262, 33.272, 33.292, 33.322, 33.332, 33.342, 33.362, 33.372, 33.402, 33.422, 33.462, 33.502				
35.262, 35.272, 35.292, 35.302, 35.322, 35.332, 35.342, 35.362, 35.372, 35.402, 35.422				
40.372, 40.402, 40.422, 40.462, 40.502				
41.262, 41.272, 41.292, 41.322, 41.332, 41.342, 41.362, 41.372, 41.402, 41.422				
48.292, 48.332, 48.362, 48.462				
				
19.242 - 48.462 (F 90-series)	07/88->09/90			H3 fog light, only spare parts available
		9DF 112 246-001	1	Spare Parts: Reflector with lens
		8GH 002 090-251	1	Accessories: 1x24V70W (H3)





Manufacturer Model	Model year	Part no.	Pk.	Note
MAN				
19.242 - 48.462 (F 90)		1NE 006 300-051	1	H3 fog light
19.242 - 48.462 (F 90-series)	10/90->04/93	1NE 138 555-011	1	Spare Parts: Light unit
		8GH 002 090-251	1	Accessories: 1x24V70W (H3)
19.242 - 48.462 (F 90-series)	05/93->12/97	1NE 006 300-231	1	H3 fog light
		1NE 138 555-011	1	Spare Parts: Light unit
		8GH 002 090-251	1	Accessories: 1x24V70W (H3)
19.242 - 48.462 (F 90-series)	06/86->12/97	2BA 007 840-001	1	Indicator light
		8GA 002 073-241	1	Accessories: 1x24V21W (P21W)





MAN



Manufacturer Model	Model year	Part no.	Pk.	Note
MAN				
19.242 - 48.462 (F 90)				
19.242 - 48.462 (F 90-series)	06/86->91			Combination rearlight available as separate parts only as follows (modular system).
19.242, 19.262, 19.272, 19.292, 19.322, 19.332, 19.342, 19.362, 19.372, 19.402, 19.422, 19.462, 19.502		9BG 130 945-001 9BG 130 946-001	2 2	Body with central plug, left Body with central plug, right (The existing licence plate window in the body should be closed if not required with cover 9HB 126 601-001)
24.242, 24.262, 24.272, 24.292, 24.302, 24.322, 24.332, 24.342, 24.362, 24.372, 24.402, 24.422, 24.462, 24.502		9EL 122 689-051 9EL 122 689-021	2 2	Suitable lenses: Lens for rear, reflex-reflector, stop, indicator and reverse light Lens for rear, reflex-reflector, stop, indicator, reverse-rear fog light
25.272, 25.302, 25.322, 25.372, 25.422, 25.502				Accessories: Cover for licence plate window
26.242, 26.262, 26.272, 26.292, 26.302, 26.322, 26.332, 26.342, 26.362, 26.372, 26.402, 26.422, 26.462, 26.502		9HB 126 601-001 9GP 003 995-801 8GA 002 071-251 8GA 002 073-241	1 1 1 1	Vibration damper set 1x24V10W (R10W) 4x24V21W (P21W)
32.262, 32.272, 32.292, 32.302, 32.322, 32.332, 32.342, 32.362, 32.372, 32.402, 32.422				
33.242, 33.262, 33.272, 33.292, 33.322, 33.332, 33.342, 33.362, 33.372, 33.402, 33.422, 33.462, 33.502				
35.262, 35.272, 35.292, 35.302, 35.322, 35.332, 35.342, 35.362, 35.372, 35.402, 35.422				
40.372, 40.402, 40.422, 40.462, 40.502				
41.262, 41.272, 41.292, 41.322, 41.332, 41.342, 41.362, 41.372, 41.402, 41.422				
48.292, 48.332, 48.362, 48.462				
				
19.242 - 48.462 (F 90-series)	06/86->91	2KA 003 389-081	1	Licence plate light
		9BG 121 587-031	2	Spare Parts: Body/lens with screw
		8GA 002 071-251	1	Accessories: 1x24V10W (R10W)
				





Manufacturer Model	Model year	Part no.	Pk.	Note
MAN				
19.242 - 48.462 (F 90)		2XS 005 020-041	10	Clearance light (red)
19.242 - 48.462 (F 90-series)	06/86->12/97	9EL 132 215-011	2	Spare Parts: Body/lens with screws
		8GP 002 067-241	1	Accessories: 1x24V4W (T4W)
19.233 - 41.464 (F 2000)		2VD 008 204-051	1	Combination rearlight, left, with licence plate, rear fog, reverse and clearance light, with reflex-reflector and centre plug
19.233 - 41.464 (F 2000-series)	01/94->	2VP 008 204-041	1	Combination rearlight, left/right, with rear fog, reverse and clearance light, with reflex-reflector and centre plug
19.233, 19.273, 19.293, 19.314, 19.323, 19.343, 19.364, 19.373, 19.403, 19.414, 19.423, 19.463, 19.464, 19.603		2VD 008 204-071	1	Combination rearlight, left, with licence plate, rear fog, reverse, clearance light, side-marker light, with reflex-reflector, marker reflex-reflector and centre plug
23.293, 23.314, 23.343, 23.364, 23.403, 23.414, 23.463, 23.464		2VP 008 204-061	1	Combination rearlight, left/right, with rear fog, reverse, clearance light, side-marker light, with reflex-reflector, marker reflex-reflector and centre plug
24.273, 24.293, 24.314, 24.323, 24.343, 24.364, 24.373, 24.403, 24.414, 24.423, 24.463, 24.464		9EL 152 889-001	1	Spare Parts: Lens with screws
26.233, 26.273, 26.293, 26.314, 26.323, 26.343, 26.364, 26.373, 26.403, 26.414, 26.423, 26.463, 26.464, 26.603, 26.604		8GA 002 071-241	1	Accessories: 3x24V5W (R5W)
27.273, 27.293, 27.314, 27.323, 27.343, 27.364, 27.403, 27.414, 27.423, 27.463, 27.464, 27.603		8GA 002 073-241	1	Accessories: 4x24V21W (P21W)
32.293, 32.314, 32.343, 32.403, 32.414, 32.364, 32.463, 32.464				
33.323, 33.343, 33.364, 33.373, 33.403, 33.414, 33.423, 33.463, 33.464, 33.603				
35.314, 35.343, 35.364, 35.373, 35.403, 35.414, 35.463, 35.464				
37.414, 37.464				
40.273, 40.373, 40.403, 40.414, 40.423, 40.463				
41.343, 41.364, 41.373, 41.403, 41.414, 41.423, 41.463, 41.464				
				



MAN







Manufacturer Model	Model year	Part no.	Pk.	Note
MAN				
19.233 - 41.464 (F 2000)	01/94->	2KA 003 389-081	1	Licence plate light
19.233 - 41.464 (F 2000)	01/94->	9BG 121 587-031	2	Spare Parts: Body/lens with screw
		8GA 002 071-251	1	Accessories: 1x24V10W (R10W)
19.233 - 41.464 (F 2000)	01/94->	2XS 005 020-041	10	Clearance light (red)
		9EL 132 215-011	2	Spare Parts: Body/lens with screws
		8GP 002 067-241	1	Accessories: 1x24V4W (T4W)



Manufacturer Model	Model year	Part no.	Pk.	Note
MAN				
18.310 - 41.660 (TGA)		2VD 008 204-251	1	Combination rearlight, left, with licence plate, rear fog, reverse, clearance light, side-marker light, with reflex-reflector and marker reflex-reflector
18.310 - 41.660 (TGA)	04/00->05/05			
18.310, 18.320, 18.350, 18.360, 18.390, 18.400, 18.410, 18.430, 18.440, 18.460, 18.480, 18.510, 18.530, 18.540		2VP 008 204-241	1	Combination rearlight, left/right, with rear fog, reverse, clearance light, side-marker light, with reflex-reflector and marker reflex-reflector
19.350, 19.360, 19.390, 19.400, 19.410, 19.430, 19.440, 19.460, 19.480, 24.440, 24.460, 24.480,		9EL 152 889-001	1	Spare Parts: Lens with screws
24.350, 24.360, 24.390, 24.400, 24.410, 24.430, 24.510, 24.530		8GA 002 071-241	1	Accessories: 3x24V5W (R5W) 4x24V21W (P21W)
		8GA 002 073-241	1	
26.280, 26.310, 26.320, 26.330, 26.350, 26.360, 26.390, 26.400, 26.410, 26.430, 26.440, 26.460, 26.480, 26.510, 26.530, 26.540				
28.310, 28.320, 28.350, 28.360, 28.390, 28.400, 28.410, 28.430, 28.440, 28.460, 28.480, 28.510, 28.530, 28.540				
32.310, 32.350, 32.360, 32.390, 32.400, 32.410, 32.430, 32.440, 32.460, 32.480				
33.340, 33.350, 33.360, 33.390, 33.400, 33.410, 33.430, 33.440, 33.460, 33.480, 33.510, 33.530				
35.310, 35.320, 35.350, 35.360, 35.390, 35.400, 35.410, 35.430, 35.440, 35.460, 35.480, 35.530				
37.310, 37.320, 37.350, 37.360, 37.390, 37.400, 37.410, 37.430, 37.440, 37.460, 37.480, 37.530				
39.390, 39.400, 39.430, 39.440, 39.480				
40.390, 40.410, 40.440, 40.460, 40.480				
41.350, 41.360, 41.390, 41.400, 41.410, 41.430, 41.440, 41.460, 41.480, 41.530, 41.660				





Manufacturer Model	Model year	Part no.	Pk.	Note
MAN				
18.310 - 41.660 (TGA)		2KA 003 389-081	1	Licence plate light
18.310 - 41.660 (TGA)	04/00->	9BG 121 587-031	2	Spare Parts: Body/lens with screw
		8GA 002 071-251	1	Accessories: 1x24V10W (R10W)
				
MAN/VW				
6.90 F - 9.136 F		1L8 003 060-561	1	Headlight
6.90 F - 9.136 F Cooperation programme	10/79->08/87	9GH 116 966-011	10	Spare Parts: Cap
		9FF 126 444-001	10	Bulb socket for side light
		8GD 002 088-251	1	1x24V55/50W (R2)
		8GP 002 067-241	1	1x24V4W (T4W)
		1L8 003 060-691	1	H4 headlight
		9GH 116 966-011	10	Spare Parts: Cap
		9FF 126 444-001	10	Accessories: Bulb socket for side light
		8GJ 002 525-251	1	Spare Parts: 1x24V75/70W (H4)
		8GP 002 067-241	1	1x24V4W (T4W)
				
6.90 F - 9.150 F		Combination rearlight available as separate parts only as follows (modular system).		
6.90 F - 9.150 F Cooperation programme	10/79->91	9BG 130 945-001	2	Body with central plug, left
		9BG 130 946-001	2	Body with central plug, right (The existing licence plate window in the body should be closed if not required with cover 9HB 126 601-001)
6.90 F, 8.90 F, 8.136 F, 9.136 F	10/79->08/87	9EL 122 689-051	2	Suitable lenses: Lens for rear, reflex-reflector, stop, indicator and reverse light
		9EL 122 689-021	2	Lens for rear, reflex-reflector, stop, indicator, reverse-rear fog light
6.100 F, 8.100 F, 8.150 F, 9.150 F	09/87->91	9HB 126 601-001	2	Accessories: Cover for licence plate window
		9GP 003 995-801	1	Vibration damper set
		8GA 002 071-251	1	1x24V10W (R10W)
		8GA 002 073-241	1	4x24V21W (P21W)
				
Mercedes-Benz				
Actros		2BM 006 692-011	1	Auxiliary indicator light, left
		2BM 006 692-021	1	Auxiliary indicator light, right
Actros 1831 - 4148	09/96->10/02	8GA 002 073-241	1	Accessories: 1x24V21W (P21W)
				





Manufacturer Model	Model year	Part no.	Pk.	Note
Mercedes-Benz				
Actros		2VD 007 500-411	1	Combination rearlight, left, with licence plate, rear fog, reverse, clearance light, side-marker light, with reflex-reflector and marker reflex-reflector and lateral centre plug
Actros 1831 - 4148	09/96->10/02			Combination rearlight, right, with licence plate, rear fog, reverse, clearance light, side-marker light, with reflex-reflector and marker reflex-reflector and centre plug only spare parts available
1831, 1835, 1840, 1843, 1848, 1853, 1857				Combination rearlight, left, with reverse, clearance light, side-marker light, with reflex-reflector and marker reflex-reflector, with bulbs and centre plug only spare parts available
2031, 2035, 2040, 2043, 2048, 2053		2VP 007 500-421	1	Combination rearlight, right, with reverse, clearance light, side-marker light, with reflex-reflector and marker reflex-reflector, with bulbs and lateral centre plug
2531, 2535, 2540, 2543, 2548, 2553, 2557		2VP 007 500-521	1	Combination rearlight, right, with reverse, clearance light, side-marker light, with reflex-reflector and marker reflex-reflector, with bulbs and lateral centre plug, with reverse alarm
2631, 2635, 2640, 2643, 2648, 2653, 2657				Spare Parts: 1 Lens with screws, left 1 Lens with screws, right 4 Lens for licence plate light 2 Side-marker light with reflector 1 3x24V10W (R10W) 1 4x24V21W (P21W)
3231, 3235, 3240, 3243				
3331, 3335, 3340, 3343, 3346, 3348, 3353, 3357				
4140, 4143, 4148				
Actros 1831 - 4148	09/96->10/02	2VB 004 887-011	1	Combination rearlight, left, with licence plate and rear fog light
1831, 1835, 1840, 1843, 1848, 1853, 1857		2VA 004 887-031	1	Combination rearlight, left, with rear fog light
2031, 2035, 2040, 2043, 2048, 2053		2VP 004 887-021	1	Combination rearlight, right, with reverse light
2531, 2535, 2540, 2543, 2548, 2553, 2557				Spare Parts: 1 Lens with screws, left 1 Lens with screws, right
2631, 2635, 2640, 2643, 2648, 2653, 2657		9EL 131 420-001	1	Lens with screws, left
		9EL 131 420-011	1	Lens with screws, right
3231, 3235, 3240, 3243		9GT 141 941-001	10	Grommet
3331, 3335, 3340, 3343, 3346, 3348, 3353, 3357		8GA 002 071-251	1	1x24V10W (R10W)
4140, 4143, 4148		8GA 002 073-241	1	3x24V21W (P21W)
various models				



Manufacturer Model	Model year	Part no.	Pk.	Note
Mercedes-Benz				
Actros MP2/MP3				
Actros MP2 1832 - 4160	10/02->06/08	1LH 009 513-051	1	Conversion headlights for Actros MP2
1832, 1836, 1841, 1844, 1846, 1848, 1850, 1851, 1854, 1858, 1860		1LH 009 513-061	1	H1/H7 headlight, left, with indicator light, without headlight leveller, with bulbs, without outer rim
2032, 2036, 2041, 2044, 2046, 2048, 2050, 2051		1LH 009 513-071	1	H1/H7 headlight, right, with indicator light, with headlight leveller, with bulbs, without outer rim
2532, 2536, 2541, 2544, 2546, 2548, 2551, 2555, 2560		1LH 009 513-081	1	H1/H7 headlight, left, with indicator light, with headlight leveller, with bulbs, without outer rim
2632, 2636, 2641, 2644, 2646, 2648, 2650, 2651, 2654, 2655, 2658		9ES 170 064-011	1	H1/H7 headlight, right, with indicator light, with headlight leveller, with bulbs, without outer rim
3232, 3236, 3241, 3244, 3246, 3248		9ES 170 064-021	1	Spare Parts: Cover lens, left
3331, 3332, 3336, 3341, 3344, 3346, 3348, 3350, 3351, 3354, 3355, 3360		8GH 007 157-241	1	Cover lens, right
4140, 4141, 4144, 4146, 4148, 4151, 4160		8GH 002 089-251	1	1x24V70W (H7)
		8GP 003 594-251	1	1x24V70W (H1)
		8GA 006 841-241	1	1x24V5W (W5W)
			1	1x24V21W (PY21W)
		9AB 165 229-031	1	The following components must be ordered in addition:
		9AB 165 230-031	1	Outer rim, left
			1	Outer rim, right
				Base, left (MB no. A 943 880 64 14)
				Base, right (MB no. A 943 880 65 14)
				In addition, screws (2x M8 x 20mm, 2x 4.2 x 20mm), washers (6x M8) and 8 cable ties are required.







Manufacturer Model	Model year	Part no.	Pk.	Note
Mercedes-Benz				
Actros MP2/MP3 Actros MP3 1832 - 5048 1832, 1836, 1841, 1844, 1846, 1848, 1850, 1851, 1854, 1855, 1858, 1860, 1861 2032, 2036, 2041, 2044, 2046, 2048, 2050, 2051, 2055 2432, 2436, 2441, 2444, 2446, 2448 2532, 2536, 2541, 2544, 2546, 2548, 2551, 2555, 2560 2632, 2636, 2641, 2644, 2646, 2648, 2650, 2651, 2654, 2655, 2658, 2660 2732, 2736, 2741, 2744, 2746, 2748 3231, 3232, 3236, 3241, 3244, 3246, 3248 3331, 3332, 3336, 3341, 3344, 3346, 3348, 3350, 3351, 3354, 3355, 3360 4140, 4141, 4144, 4146, 4148, 4151, 4160 5041, 5044, 5046, 5048	06/08->	1LH 009 513-051 1LH 009 513-061 1LH 009 513-071 1LH 009 513-081 9AB 165 229-031 9AB 165 230-031 9ES 170 064-011 9ES 170 064-021 8GH 007 157-241 8GH 002 089-251 8GP 003 594-251 8GA 006 841-241	1 1 1 1 1 1 1 1 1 1	H1/H7 headlight, left, with indicator light, without headlight leveller, with bulbs, without outer rim H1/H7 headlight, right, with indicator light, with headlight leveller, with bulbs, without outer rim H1/H7 headlight, left, with indicator light, with headlight leveller, with bulbs, without outer rim H1/H7 headlight, right, with indicator light, with headlight leveller, with bulbs, without outer rim Accessories: Outer rim, left Outer rim, right Spare Parts: Cover lens, left Cover lens, right Accessories: 1x24V70W (H7) 1x24V70W (H1) 1x24V5W (W5W) 1x24V21W (PY21W)
				
Actros MP3 1832 - 5048	06/08->	9AB 165 229-031 9AB 165 230-031	1 1	Outer rim, left Outer rim, right
				
Actros MP3 1832 - 5048	06/08->	5DV 008 856-001	1	Ballast unit
				



Manufacturer Model	Model year	Part no.	Pk.	Note
Mercedes-Benz				
Actros MP2/MP3		2VD 007 500-411	1	Combination rearlight, left, with licence plate, rear fog, reverse, clearance light, side-marker light, with reflex-reflector and marker reflex-reflector and lateral centre plug
Actros MP2/MP3 1832 - 5048	10/02->			
1832, 1836, 1841, 1844, 1846, 1848, 1850, 1851, 1854, 1855, 1858, 1860, 1861				Combination rearlight, right, with licence plate, rear fog, reverse, clearance light, side-marker light, with reflex-reflector and marker reflex-reflector and centre plug only spare parts available
2032, 2036, 2041, 2044, 2046, 2048, 2050, 2051, 2055				Combination rearlight, left, with reverse, clearance light, side-marker light, with reflex-reflector and marker reflex-reflector, with bulbs and centre plug only spare parts available
2432, 2436, 2441, 2444, 2446, 2448				
2532, 2536, 2541, 2544, 2546, 2548, 2551, 2555, 2560		2VP 007 500-421	1	Combination rearlight, right, with reverse, clearance light, side-marker light, with reflex-reflector and marker reflex-reflector, with bulbs and lateral centre plug
2632, 2636, 2641, 2644, 2646, 2648, 2650, 2651, 2654, 2655, 2658, 2660		2VP 007 500-521	1	Combination rearlight, right, with reverse, clearance light, side-marker light, with reflex-reflector and marker reflex-reflector, with bulbs and lateral centre plug, with reverse alarm
2732, 2736, 2741, 2744, 2746, 2748				
3231, 3232, 3236, 3241, 3244, 3246, 3248		9EL 134 296-041	1	Spare Parts: Lens with screws, left
3331, 3332, 3336, 3341, 3344, 3346, 3348, 3350, 3351, 3354, 3355, 3360		9EL 134 296-051	1	Lens with screws, right
4140, 4141, 4144, 4146, 4148, 4151, 4160		9EL 134 301-001	4	Lens for licence plate light
5041, 5044, 5046, 5048		9EL 146 838-001	2	Side-marker light with reflector ->12/07
		8GA 002 071-251	1	3x24V10W (R10W)
		8GA 002 073-241	1	4x24V21W (P21W)







Manufacturer Model	Model year	Part no.	Pk.	Note
Mercedes-Benz				
Actros MP2/MP3		2VB 004 887-011	1	Combination rearlight, left, with licence plate and rear fog light
Actros MP2/MP3 1832 - 5048	10/02->	2VA 004 887-031	1	Combination rearlight, left, with rear fog light
1832, 1836, 1841, 1844, 1846, 1848, 1850, 1851, 1854, 1855, 1858, 1860, 1861		2VP 004 887-021	1	Combination rearlight, right, with reverse light
2032, 2036, 2041, 2044, 2046, 2048, 2050, 2051, 2055		9EL 131 420-001	1	Spare Parts: Lens with screws, left
2432, 2436, 2441, 2444, 2446, 2448		9EL 131 420-011	1	Lens with screws, right
2532, 2536, 2541, 2544, 2546, 2548, 2551, 2555, 2560		9GT 141 941-001	10	Accessories: Grommet
2632, 2636, 2641, 2644, 2646, 2648, 2650, 2651, 2654, 2655, 2658, 2660		8GA 002 071-251	1	1x24V10W (R10W)
2732, 2736, 2741, 2744, 2746, 2748		8GA 002 073-241	1	3x24V21W (P21W)
3231, 3232, 3236, 3241, 3244, 3246, 3248				
3331, 3332, 3336, 3341, 3344, 3346, 3348, 3350, 3351, 3354, 3355, 3360				
4140, 4141, 4144, 4146, 4148, 4151, 4160				
5041, 5044, 5046, 5048				
various models				
				
Atego		2VD 008 204-091	1	Combination rearlight, left, with licence plate, rear fog, reverse, clearance light, side-marker light, with reflex-reflector, marker reflex-reflector and centre plug (middle)
Atego 712 - 1528	01/98->10/04	2VP 008 204-081	1	Combination rearlight, right, with reverse, clearance light, side-marker light, with reflex-reflector, marker reflex-reflector and centre plug (middle)
712, 714, 715, 717		9EL 152 891-001	1	Spare Parts: Lens with screws
812, 814, 815, 817, 823		8GA 002 071-241	1	Accessories: 3x24V5W (R5W)
917, 923, 925		8GA 002 073-241	1	4x24V21W (P21W)
1017, 1023				
1214, 1215, 1217, 1223, 1225, 1228				
1317, 1323, 1325, 1328				
1517, 1523, 1525, 1528				
				





Manufacturer Model	Model year	Part no.	Pk.	Note
Mercedes-Benz				
Atego Atego 1823 - 2628 1823, 1828 2523, 2528 2628 (-) Dump truck	01/98->10/04	2VD 007 500-411	1	Combination rearlight, left, with licence plate, rear fog, reverse, clearance light, side-marker light, with reflex-reflector and marker reflex-reflector and lateral centre plug Combination rearlight, right, with licence plate, rear fog, reverse, clearance light, side-marker light, with reflex-reflector and marker reflex-reflector and centre plug only spare parts available Combination rearlight, left, with reverse, clearance light, side-marker light, with reflex-reflector and marker reflex-reflector, with bulbs and centre plug only spare parts available
		2VP 007 500-421	1	Combination rearlight, right, with reverse, clearance light, side-marker light, with reflex-reflector and marker reflex-reflector, with bulbs and lateral centre plug
		2VP 007 500-521	1	Combination rearlight, right, with reverse, clearance light, side-marker light, with reflex-reflector and marker reflex-reflector, with bulbs and lateral centre plug, with reverse alarm
		9EL 134 296-041 1 Lens with screws, left 9EL 134 296-051 1 Lens with screws, right 9EL 134 301-001 4 Lens for licence plate light 9EL 146 838-001 2 Side-marker light with reflector 8GA 002 071-251 1 3x24V10W (R10W) 8GA 002 073-241 1 4x24V21W (P21W)		Spare Parts: 1 Lens with screws, left 1 Lens with screws, right 4 Lens for licence plate light 2 Side-marker light with reflector 1 3x24V10W (R10W) 1 4x24V21W (P21W)
Atego 1823 - 2628 1823, 1828 2523, 2528 2628 Platform truck	01/98->10/04	2VB 004 887-011	1	Combination rearlight, left, with licence plate and rear fog light
		2VA 004 887-031	1	Combination rearlight, left, with rear fog light
		2VP 004 887-021	1	Combination rearlight, right, with reverse light
		9EL 131 420-001 1 Lens with screws, left 9EL 131 420-011 1 Lens with screws, right Accessories: 10 Grommet 1 1x24V10W (R10W) 1 3x24V21W (P21W)		Spare Parts: 1 Lens with screws, left 1 Lens with screws, right Accessories: 10 Grommet 1 1x24V10W (R10W) 1 3x24V21W (P21W)
Atego II Atego II 712 - 1629	10/04->	2BA 247 016-031	1	Indicator light, left
		2BA 247 016-041	1	Indicator light, right
		8GA 006 841-241	1	Accessories: 1x24V21W (PY21W)







Manufacturer Model	Model year	Part no.	Pk.	Note
Mercedes-Benz				
Axor Axor 1823 - 3228 1823, 1835, 1840, 1843 2523, 2528, 2535, 2540, 2543 2623, 2628 3228 	01/02->10/04	2VD 007 500-411	1	Combination rearlight, left, with licence plate, rear fog, reverse, clearance light, side-marker light, with reflex-reflector and marker reflex-reflector and lateral centre plug Combination rearlight, right, with licence plate, rear fog, reverse, clearance light, side-marker light, with reflex-reflector and marker reflex-reflector and centre plug only spare parts available Combination rearlight, left, with reverse, clearance light, side-marker light, with reflex-reflector and marker reflex-reflector, with bulbs and centre plug only spare parts available
		2VP 007 500-421	1	Combination rearlight, right, with reverse, clearance light, side-marker light, with reflex-reflector and marker reflex-reflector, with bulbs and lateral centre plug
		2VP 007 500-521	1	Combination rearlight, right, with reverse, clearance light, side-marker light, with reflex-reflector and marker reflex-reflector, with bulbs and lateral centre plug, with reverse alarm Spare Parts: 1 Lens with screws, left 1 Lens with screws, right 4 Lens for licence plate light 2 Side-marker light with reflector 1 3x24V10W (R10W) 1 4x24V21W (P21W)
		9EL 134 296-041 9EL 134 296-051 9EL 134 301-001 9EL 146 838-001 8GA 002 071-251 8GA 002 073-241	1 1 4 2 1 1	
Axor II Axor II 1823 - 3343 1823, 1824, 1826, 1828, 1829, 1833, 1836, 1840, 1843 2436, 2440, 2443 2528, 2529, 2533, 2535, 2536, 2540, 2543 2628, 2629, 2633, 2636, 2640, 2643 3236, 3240, 3243 3335, 3340, 3343 	10/04->	1LB 247 011-051	1	H1/H7 headlight, left, without indicator light, without headlight leveller, without lens cleaning system, with bulbs
		1LB 247 011-061	1	H1/H7 headlight, right, without indicator light, without headlight leveller, without lens cleaning system, with bulbs Spare Parts: 1 Cover lens, left 1 Cover lens, right 1 Base for indicator light, left 1 Base for indicator light, right 1 Base top 1 Base bottom 1 Cap 1 1x24V70W (H7) 1 1x24V70W (H1) 1 1x24V5W (W5W)
		9ES 247 753-001 9ES 247 754-001 9XD 247 755-001 9XD 247 756-001 8HG 247 376-011 8HG 247 377-011 9GH 156 191-001 8GH 007 157-241 8GH 002 089-251 8GP 003 594-251	1 1 1 1 1 1 1 1 1 1 1	
Axor II 1824 - 3343 	10/04->	2BA 247 015-031	1	Indicator light, left, with bulb
		2BA 247 015-041	1	Indicator light, right, with bulb
		8GA 006 841-241	1	Spare Parts: 1x24V21W (PY21W)



Manufacturer Model	Model year	Part no.	Pk.	Note
Mercedes-Benz				
Axor II		2VD 007 500-411	1	Combination rearlight, left, with licence plate, rear fog, reverse, clearance light, side-marker light, with reflex-reflector and marker reflex-reflector and lateral centre plug
Axor II 1823 - 3343	10/04->			
1823, 1824, 1826, 1828, 1829, 1833, 1836, 1840, 1843				
2436, 2440, 2443				
2528, 2529, 2533, 2535, 2536, 2540, 2543				
2628, 2629, 2633, 2636, 2640, 2643				
3236, 3240, 3243				
3335, 3340, 3343				
		2VP 007 500-421	1	Combination rearlight, right, with reverse, clearance light, side-marker light, with reflex-reflector and marker reflex-reflector, with bulbs and lateral centre plug
		2VP 007 500-521	1	Combination rearlight, right, with reverse, clearance light, side-marker light, with reflex-reflector and marker reflex-reflector, with bulbs and lateral centre plug, with reverse alarm
		9EL 134 296-041	1	Lens with screws, left
		9EL 134 296-051	1	Lens with screws, right
		9EL 134 301-001	4	Lens for licence plate light
		9EL 146 838-001	2	Side-marker light with reflector ->12/07
		8GA 002 071-251	1	3x24V10W (R10W)
		8GA 002 073-241	1	4x24V21W (P21W)
Cab-behind-engine vehicles 911 - 2624				Headlight, only spare parts available Lens-retaining rim chrome-plated
Cab-behind-engine vehicles 911 - 2624				
		9ES 091 489-001	5	Lens, left
		9DR 080 706-015	1	Reflector, left
		8GD 002 088-131	1	1x12V45/40W (R2)
		8GP 002 067-121	1	1x12V4W (T4W)
Cab-behind-engine vehicles 911 - 2624				Headlight, only spare parts available Lens-retaining rim and grille grey coloured
Cab-behind-engine vehicles 911 - 2624				
		9ES 091 489-001	5	Lens, left
		9DR 080 706-015	1	Reflector, left
		8GD 002 088-131	1	1x12V45/40W (R2)
		8GP 002 067-121	1	1x12V4W (T4W)







Manufacturer Model	Model year	Part no.	Pk.	Note
Mercedes-Benz				
Cab-behind-engine vehicles 911 - 2624 Cab-behind-engine vehicles 2624 			1	Headlight, only spare parts available
		9ES 084 374-001 9GD 052 710-021 9DE 089 102-011 9FF 085 642-001 8GD 002 088-131 8GP 002 067-121	5 10 1 10 1 1	Spare Parts: Lens Seal for lens Reflector Bulb socket for side light 1x12V45/40W (R2) 1x12V4W (T4W)
Cab-behind-engine vehicles 911 - 2624 		2BA 001 234-251 2BA 001 234-261	2 2	Indicator light, left Indicator light, right
		9EL 109 440-002 8GA 002 073-121	5 1	Spare Parts: Body/lens with cap and screw 1x12V21W (P21W)
Cab-behind-engine vehicles 911 - 2624 		2PF 001 638-011	2	Side light (clear)
		8GA 002 071-121	1	Spare Parts: 1x12V5W (R5W)
		2SA 001 638-021	2	Rear light (red)
		9EL 107 443-061 8GP 003 594-121	2 1	Spare Parts: Body/lens with screw 1x12V5W (W5W)
		2PF 001 638-067	40	Side light (amber)
	8GA 002 071-121	1	Spare Parts: 1x12V5W (R5W)	
Cab-behind-engine vehicles 911 - 2624 		2BA 001 259-618	108	Indicator light (amber)
		9EL 088 150-001 8GM 002 091-121	2 1	Spare Parts: Body/lens with screws 1x12V18W (K)
		2PF 001 259-631	2	Side light (clear)
		9EL 109 208-011	2	Spare Parts: Body/lens with screws
		2PF 001 259-677	108	Side light (green)
		2PF 001 259-687	108	Side light (blue)
		2SA 001 259-757	108	Side light (red)
	8GM 002 092-121	1	Spare Parts: 1x12V5W (C5W)	
Cab-behind-engine vehicles 911 - 2624 		2PF 001 647-031	4	Side light
		8GA 002 071-131	1	Spare Parts: 1x12V10W (R10W)









Manufacturer Model	Model year	Part no.	Pk.	Note
Mercedes-Benz				
Cab-behind-engine vehicles 911 - 2624		2SE 001 685-201	1	Combination rearlight, left, with licence plate light
		2SD 001 685-211	1	Combination rearlight, right, without licence plate light
Cab-behind-engine vehicles 911 - 2624		9EL 113 324-001 8GA 002 071-121 8GA 002 073-121	2 1 1	Spare Parts: Lens with screws 1x12V5W (R5W) 2x12V21W (P21W)
Cab-behind-engine vehicles 911 - 2624		2SE 001 699-071	1	Combination rearlight, left, with licence plate light
		2SD 001 699-061	1	Combination rearlight, right, without licence plate light
Cab-behind-engine vehicles 911 - 2624		9EL 109 139-001 9GT 074 132-001 8GA 002 071-131 8GA 002 073-121	2 10 1 1	Spare Parts: Lens with screws Grommet 1x12V10W (R10W) 2x12V21W (P21W)
Cab-behind-engine vehicles 911 - 2624		2SE 003 167-031	1	Combination rearlight, left, with licence plate light
		2SD 003 167-021	1	Combination rearlight, right, without licence plate light
Cab-behind-engine vehicles 911 - 2624		9EL 147 747-001 9GD 087 883-355 8GA 002 071-131 8GA 002 073-121	1 10 1 1	Spare Parts: Lens with screws Seal 1x12V10W (R10W) 2x12V21W (P21W)
Cab-behind-engine vehicles 911 - 2624		2JA 001 357-002	6	Interior light with switch
		2JA 001 357-012	6	Interior light without switch
Cab-behind-engine vehicles 911 - 2624		8GA 002 071-131	1	Spare Parts: 2x12V10W (R10W)
LP 608 - LP 1113 (LP)				Headlight, only spare parts available
LP 709 - LP 1113 (LP)	08/81->12/84			Spare Parts:
LP 608 LP 709 LP 808, LP 809, LP 813 LP 913 LP 1013 LP 1113		9ES 120 723-001 9FH 113 447-011	2 5	Lens, left Bulb holder
		8GD 002 088-131 8GD 002 088-251 8GP 002 067-121 8GP 002 067-241	1 1 1 1	Accessories: 1x12V45/40W (R2) 1x24V55/50W (R2) 1x12V4W (T4W) 1x24V4W (T4W)
		9ES 120 725-001 9ES 120 726-001 9FH 113 447-011	2 2 5	H4 headlight, only spare parts available Spare Parts: Lens, left Lens, right Bulb holder
		8GJ 002 525-131 8GJ 002 525-251 8GP 002 067-121 8GP 002 067-241	1 1 1 1	Accessories: 1x12V60/55W (H4) 1x24V75/70W (H4) 1x12V4W (T4W) 1x24V4W (T4W)









Manufacturer Model	Model year	Part no.	Pk.	Note
Mercedes-Benz				
LP 608 - LP 1113 (LP) LP 709 - LP 1113 (LP)	11/77->12/84	2BA 003 411-001 8GA 002 073-121 8GA 002 073-241	1 1 1	Indicator light Accessories: 1x12V21W (P21W) 1x24V21W (P21W)
				
LP 608 - LP 1113 (LP) LP 608 LP 709 LP 808, LP 809, LP 813 LP 913 LP 1013 LP 1113	11/77->12/84	2SE 003 167-031 2SD 003 167-021 9EL 147 747-001 9GD 087 883-355 8GA 002 071-131 8GA 002 071-251 8GA 002 073-121 8GA 002 073-241	1 1 1 10 1 1 1 1	Combination rearlight, left, with licence plate light Combination rearlight, right, without licence plate light Spare Parts: 1 Lens with screws 10 Seal Accessories: 1x12V10W (R10W) 1x24V10W (R10W) 2x12V21W (P21W) 2x24V21W (P21W)
				
LP 608 - LP 1113 (LP)	11/77->12/84	2NE 003 236-001 9EL 119 544-001 9DX 119 545-011 8GA 002 073-121 8GA 002 073-241	1 4 2 1 1	Rear fog light Spare Parts: 4 Lens 2 Reflector Accessories: 1x12V21W (P21W) 1x24V21W (P21W)
				
LP 608 - LP 1113 (LP)	11/77->12/84	2ZR 003 236-051 9EL 119 544-111 9DX 119 545-051 8GA 002 073-121 8GA 002 073-241	1 4 2 1 1	Reverse light Spare Parts: 4 Lens 2 Reflector Accessories: 1x12V21W (P21W) 1x24V21W (P21W)
				
LP 608 - LP 1113 (LP)	10/69->12/84	2JA 001 357-002 2JA 001 357-012 8GM 002 091-131 8GM 002 091-251	6 6 1 1	Interior light with switch Interior light without switch Accessories: 2x12V10W (K) 2x24V10W (-)
				



Manufacturer Model	Model year	Part no.	Pk.	Note
Mercedes-Benz				
O 309				Headlight, only spare parts available
O 309	08/81->02/89			
		9ES 120 723-001 9FH 113 447-011 8GD 002 088-131 8GD 002 088-251 8GP 002 067-121 8GP 002 067-241	2 5 1 1 1 1	Spare Parts: Lens, left Bulb holder 1x12V45/40W (R2) 1x24V55/50W (R2) 1x12V4W (T4W) 1x24V4W (T4W)
		9ES 120 725-001 9ES 120 726-001 9FH 113 447-011 8GJ 002 525-131 8GJ 002 525-251 8GP 002 067-121 8GP 002 067-241	2 2 5 1 1 1 1	H4 headlight, only spare parts available Spare Parts: Lens, left Lens, right Bulb holder 1x12V60/55W (H4) 1x24V75/70W (H4) 1x12V4W (T4W) 1x24V4W (T4W)
O 309	01/68->03/83			
		2BA 001 275-011 2BA 001 275-021	2 2	Indicator light, left Indicator light, right
		9EL 101 899-001 9EL 101 900-001	5 5	Spare Parts: Lens, left Lens, right
		8GA 002 073-121	1	Accessories: 1x12V21W (P21W)
O 309	01/68->06/77			
		2KA 001 378-041	4	Licence plate light
		8GM 002 092-121	1	Accessories: 1x12V5W (C5W)
O 309	07/77->02/89			
		9EL 119 874-001	2	Combination rearlight, only spare parts available
		8GA 002 071-131 8GA 002 071-251 8GA 002 073-121 8GA 002 073-241	1 1 1 1	Spare Parts: Lens with screws Accessories: 1x12V10W (R10W) 1x24V10W (R10W) 2x12V21W (P21W) 2x24V21W (P21W)
O 309	07/77->02/89			
		2NE 002 589-001	1	Rear fog light
		9EL 112 763-001	5	Spare Parts: Lens with screws
		8GA 002 073-121 8GA 002 073-241	1 1	Accessories: 1x12V21W (P21W) 1x24V21W (P21W)
O 309	07/77->02/89			
		2ZR 002 589-011	1	Reverse light
		9EL 112 858-011	2	Spare Parts: Lens with screws
		8GA 002 073-121 8GA 002 073-241	1 1	Accessories: 1x12V21W (P21W) 1x24V21W (P21W)







Manufacturer Model	Model year	Part no.	Pk.	Note
Mercedes-Benz				
O 309		2KA 003 389-061	2	Licence plate light
O 309	07/77->02/89	9BG 121 587-031	2	Spare Parts: Body/lens with screw
		8GA 002 071-131	1	Accessories: 1x12V10W (R10W)
		8GA 002 071-251	1	1x24V10W (R10W)
O 309	01/68->02/89	2JA 001 357-002	6	Interior light with switch
		2JA 001 357-012	6	Interior light without switch
		8GM 002 091-131	1	Accessories: 2x12V10W (K)
		8GM 002 091-251	1	2x24V10W (-)
O 404		2BA 003 236-541	1	Flasher clearance lamp
O 404	09/91->10/99	9BG 139 863-007	150	Spare Parts: Body
		8GA 002 071-131	1	Accessories: 1x12V10W (R10W)
		8GA 002 071-251	1	1x24V10W (R10W)
		8GA 002 073-121	1	1x12V21W (P21W)
		8GA 002 073-241	1	1x24V21W (P21W)
O 404	09/91->10/99	2BM 006 692-011	1	Auxiliary indicator light, left
		2BM 006 692-021	1	Auxiliary indicator light, right
		8GA 002 073-121	1	Accessories: 1x12V21W (P21W)
		8GA 002 073-241	1	1x24V21W (P21W)
O 404	09/91->10/99	2AB 004 532-051	5	Reading light, with 28V xenon bulb
		9EL 128 922-011	10	Accessories: Lens (red)
		8GP 008 285-001	1	Spare Parts: 1x28V7,5W (-)
			1	(Xenon)
O 405		2BA 004 119-001	1	Indicator light, for front mounting
O 405	09/84->	8GA 002 073-241	1	Accessories: 1x24V21W (P21W)
				







Manufacturer Model	Model year	Part no.	Pk.	Note
Mercedes-Benz				
O 405 O 405	09/84->	 2BA 003 236-021 9EL 119 544-021 8GA 002 073-241	1 4 1	Indicator light, for rear mounting Spare Parts: Lens Accessories: 1x24V21W (P21W)
O 405	09/84->	 2NE 003 236-001 9EL 119 544-001 9DX 119 545-011 8GA 002 073-241	1 4 2 1	Rear fog light Spare Parts: Lens Reflector Accessories: 1x24V21W (P21W)
O 405	09/84->	 2ZR 003 236-051 9EL 119 544-111 9DX 119 545-051 8GA 002 073-241	1 4 2 1	Reverse light Spare Parts: Lens Reflector Accessories: 1x24V21W (P21W)
O 405 VÖV II O 405 VÖV II	01/84->	 2PF 002 860-031 9EL 116 380-035 9GD 128 553-007 8GA 002 071-251	1 5 10 1	Side light, for front mounting Spare Parts: Body/lens Base (to be ordered separately) Accessories: 1x24V10W (R10W)
O 405 VÖV II	01/84->	 2BA 002 324-011 2BA 002 324-021 9EL 110 918-001 9EL 110 918-011 8GA 002 073-241	1 1 5 5 1	Indicator light, left Indicator light, right Spare Parts: Lens with screws, left Lens with screws, right Accessories: 1x24V21W (P21W)
O 405 VÖV II	01/84->	 2SA 002 860-041 9EL 116 380-045 8GA 002 071-251	1 5 1	Side light, for rear mounting Spare Parts: Body/lens Accessories: 1x24V10W (R10W)









Manufacturer Model	Model year	Part no.	Pk.	Note
Mercedes-Benz				
O 405 VÖV II O 405 VÖV II	01/84->		9EL 118 445-001 1 9GD 087 883-355 10 9GD 118 983-021 10 8GA 002 071-251 1 8GA 002 073-241 1	Combination rearlight, only spare parts available Spare Parts: Lens with screws Seal Accessories: Bodywork seal for flush-fitting 1x24V10W (R10W) 2x24V21W (P21W)
O 405 VÖV II	01/84->		2BA 003 236-021 1 9EL 119 544-021 4 8GA 002 073-241 1	Indicator light, for rear mounting Spare Parts: Lens Accessories: 1x24V21W (P21W)
O 405 VÖV II	01/84->		2KA 003 389-061 2 9BG 121 587-031 2 8GA 002 071-251 1	Licence plate light Spare Parts: Body/lens with screw Accessories: 1x24V10W (R10W)
O 405 VÖV II	01/84->		2AB 004 532-051 5 9EL 128 922-011 10 8GP 008 285-001 1 1	Reading light, with 28V xenon bulb Accessories: Lens (red) Spare Parts: 1x28V7,5W (-) (Xenon)
O 407 O 407	03/87->11/01		2BA 004 119-001 1 8GA 002 073-241 1	Indicator light, for front mounting Accessories: 1x24V21W (P21W)



Manufacturer Model	Model year	Part no.	Pk.	Note
Mercedes-Benz				
O 407 O 407	03/87->11/01	 2BA 003 236-021 9EL 119 544-021 8GA 002 073-241	1 4 1	Indicator light, for rear mounting Spare Parts: Lens Accessories: 1x24V21W (P21W)
O 407	03/87->11/01	 2NE 003 236-001 9EL 119 544-001 9DX 119 545-011 8GA 002 073-241	1 4 2 1	Rear fog light Spare Parts: Lens Reflector Accessories: 1x24V21W (P21W)
O 407	03/87->11/01	 2ZR 003 236-051 9EL 119 544-111 9DX 119 545-051 8GA 002 073-241	1 4 2 1	Reverse light Spare Parts: Lens Reflector Accessories: 1x24V21W (P21W)
Unimog Unimog U 600 - U 900 U 600, U 800, U 900	08/90->05/92	 1L8 003 060-691 9GH 116 966-011 9FF 126 444-001 8GJ 002 525-251 8GP 002 067-241	1 10 10 1 1	H4 headlight Spare Parts: Cap Bulb socket for side light (to be ordered separately) 1x24V75/70W (H4) 1x24V4W (T4W)
Unimog U 1000 - U 1700		 2XS 004 237-291 2XS 004 237-301 8GA 002 071-121 8GA 002 071-241	1 1 1 1	Clearance light (white), left, for front mounting Clearance light (white), right, for front mounting Accessories: 1x12V5W (R5W) 1x24V5W (R5W)







Manufacturer Model	Model year	Part no.	Pk.	Note
Mercedes-Benz				
Unimog Unimog U 95, U 120, U 150 (425) Unimog U 1300, U 1500, U 1700 	->12/76	2SE 001 699-071 2SD 001 699-061 9EL 109 139-001 9GT 074 132-001 8GA 002 071-131 8GA 002 071-251 8GA 002 073-121 8GA 002 073-241	1 1 2 10 1 1 1 1	Combination rearlight, left, with licence plate light Combination rearlight, right, without licence plate light Spare Parts: Lens with screws Grommet Accessories: 1x12V10W (R10W) 1x24V10W (R10W) 2x12V21W (P21W) 2x24V21W (P21W)
Unimog U 1000 - U 1700 		2ZR 003 236-051 9EL 119 544-111 9DX 119 545-051 8GA 002 073-121 8GA 002 073-241	1 4 2 1 1	Reverse light Spare Parts: Lens Reflector Accessories: 1x12V21W (P21W) 1x24V21W (P21W)
Unimog U 52 - U 150 Unimog U 1000 - U 1700 	->12/76 01/77->	2JA 001 357-002 2JA 001 357-012 8GM 002 091-131 8GM 002 091-251	6 6 1 1	Interior light with switch Interior light without switch Accessories: 2x12V10W (K) 2x24V10W (-)
507 D - 814 D (T2/LN1) 507 D - 814 D (T2/LN1) 	04/86->12/94	1ND 122 390-001 8GH 002 090-133 8GH 002 090-251	1 1 1	H3 fog light unit Accessories: 1x12V55W (H3) 1x24V70W (H3)
507 D - 814 D (T2/LN1) Flatbed 	04/86->12/94	2BM 002 652-051 8GA 002 073-121 8GA 002 073-241	1 1 1	Auxiliary indicator light Accessories: 1x12V21W (P21W) 1x24V21W (P21W)
507 D - 814 D (T2/LN1) Van 	04/86->12/94	2BM 002 652-071 2BM 002 652-081 8GA 002 073-121 8GA 002 073-241	1 1 1 1	Auxiliary indicator light, left Auxiliary indicator light, right Accessories: 1x12V21W (P21W) 1x24V21W (P21W)





Manufacturer Model	Model year	Part no.	Pk.	Note
Mercedes-Benz				
507 D - 814 D (T2/LN1)		2BM 006 692-011	1	Auxiliary indicator light, left
507 D - 814 D (T2/LN1)	05/94->12/94	2BM 006 692-021	1	Auxiliary indicator light, right
		8GA 002 073-121	1	Accessories: 1x12V21W (P21W)
		8GA 002 073-241	1	1x24V21W (P21W)
507 D - 814 D (T2/LN1)	04/86->12/94	2VB 004 887-011	1	Combination rearlight, left, with licence plate and rear fog light
507 D, 508 D, 510, 609 D, 611 D, 709 D, 711 D, 714 D, 809 D, 811 D, 814 D		2VA 004 887-031	1	Combination rearlight, left, with rear fog light
Platform truck Van		2VP 004 887-021	1	Combination rearlight, right, with reverse light
O 609, O 611 D, O 614 D	07/87->12/92	9EL 131 420-001	1	Spare Parts: Lens with screws, left
		9EL 131 420-011	1	Lens with screws, right
		9GT 141 941-001	10	Accessories: Grommet
		8GA 002 071-131	1	1x12V10W (R10W)
		8GA 002 071-251	1	1x24V10W (R10W)
		8GA 002 073-121	1	3x12V21W (P21W)
		8GA 002 073-241	1	3x24V21W (P21W)
507 D - 814 D (T2/LN1)	04/86->12/94	2KA 003 389-061	2	Licence plate light
Van		9BG 121 587-031	2	Spare Parts: Body/lens with screw
O 609, O 611 D, O 614 D	07/87->12/92	8GA 002 071-131	1	Accessories: 1x12V10W (R10W)
		8GA 002 071-251	1	1x24V10W (R10W)
507 D - 814 D (T2/LN1)	04/86->12/94	2XS 004 237-291	1	Clearance light (white), left, for front mounting
		2XS 004 237-301	1	Clearance light (white), right, for front mounting
		8GA 002 071-121	1	Accessories: 1x12V5W (R5W)
		8GA 002 071-241	1	1x24V5W (R5W)
507 D - 814 D (T2/LN1)	04/86->12/94	2XS 004 237-311	1	Clearance light (red), left, for rear mounting
		2XS 004 237-321	1	Clearance light (red), right, for rear mounting
		8GA 002 071-121	1	Accessories: 1x12V5W (R5W)
		8GA 002 071-241	1	1x24V5W (R5W)
507 D - 814 D (T2/LN1)	04/86->12/94	2JA 001 357-002	6	Interior light with switch
		2JA 001 357-012	6	Interior light without switch
		8GM 002 091-131	1	Accessories: 2x12V10W (K)





Manufacturer Model	Model year	Part no.	Pk.	Note
Mercedes-Benz				
709 - 2024 (LK/LN2)		1ND 122 390-001	1	H3 fog light unit
709 - 2024 (LK/LN2)	01/84->12/98	8GH 002 090-251	1	Accessories: 1x24V70W (H3)
				
709 - 2024 (LK/LN2)	01/84->12/98	2BA 003 975-031 2BA 003 975-041	1 1	Indicator light, left Indicator light, right
		8GA 002 073-241	1	Accessories: 1x24V21W (P21W)
				
709 - 2024 (LK/LN2)	01/84->12/98	2XS 004 237-291 2XS 004 237-301	1 1	Clearance light (white), left, for front mounting Clearance light (white), right, for front mounting
		8GA 002 071-241	1	Accessories: 1x24V5W (R5W)
				
709 - 2024 (LK/LN2)	01/84->12/98	2BM 004 312-051 2BM 004 312-061	1 1	Auxiliary indicator light, left Auxiliary indicator light, right
		9EL 127 855-001 9EL 127 856-001	5 5	Spare Parts: Lens, left Lens, right
		8GA 002 073-241	1	Accessories: 1x24V21W (P21W)
				
709 - 2024 (LK/LN2)	05/94->12/98	2BM 006 692-011 2BM 006 692-021	1 1	Auxiliary indicator light, left Auxiliary indicator light, right
		8GA 002 073-241	1	Accessories: 1x24V21W (P21W)
				



Manufacturer Model	Model year	Part no.	Pk.	Note
Mercedes-Benz				
709 - 2024 (LK/LN2) 709 - 2024 (LK/LN2) 709 809, 814, 817 914, 917 1114, 1117, 1120 1214 1314, 1317, 1320, 1324 1514, 1517, 1520, 1524 1720, 1724 2020, 2024 	01/84->08/88	9EL 118 445-001 9GD 087 883-355 8GA 002 071-131 8GA 002 071-251 8GA 002 073-121 8GA 002 073-241	1 10 1 1 1 1	Combination rearlight, only spare parts available Spare Parts: Lens with screws Seal Accessories: 1x12V10W (R10W) 1x24V10W (R10W) 2x12V21W (P21W) 2x24V21W (P21W)
709 - 2024 (LK/LN2) 709, 711 809, 811, 814, 817 914, 917 1114, 1117, 1120, 1124 1214, 1217 1314, 1317, 1320, 1324 1514, 1517, 1520, 1524 1720, 1724 2020, 2024 	09/88->12/98	2VD 005 300-551 2VD 005 300-581 9EL 134 296-041 9EL 134 296-051 9EL 134 301-001 9EL 134 301-011 8RA 003 326-011 8GA 002 071-131 8GA 002 071-251 8GA 002 073-121 8GA 002 073-241	1 1 1 4 15 20 1 1 1 1 1	Combination rearlight, left, with licence plate, rear fog, reverse, clearance light and lateral marker reflex-reflector (in the case of use in left-hand traffic, the number plate window of the black glare shield 9EL 134 301-011, order separately) Combination rearlight, right, with licence plate, rear fog, reverse, clearance light and lateral marker reflex-reflector Spare Parts: Lens with screws, left Lens with screws, right Lens for licence plate light Glare shield, black (order separately) Reflector (amber) 3x12V10W (R10W) 3x24V10W (R10W) 4x12V21W (P21W) 4x24V21W (P21W)
709 - 2024 (LK/LN2) 	01/84->12/98	2TJ 003 168-151 8GM 002 092-121 8GM 002 092-241	2 1 1	Clearance light, for side mounting Accessories: 1x12V5W (C5W) 1x24V5W (C5W)





Manufacturer Model	Model year	Part no.	Pk.	Note
Mercedes-Benz				
709 - 2024 (LK/LN2)	01/84->12/98	2NE 003 236-001	1	Rear fog light
709 - 2024 (LK/LN2)	01/84->12/98	9EL 119 544-001 9DX 119 545-011	4 2	Spare Parts: Lens Reflector
		8GA 002 073-241	1	Accessories: 1x24V21W (P21W)
				
709 - 2024 (LK/LN2)	01/84->12/98	2ZR 003 236-051	1	Reverse light
		9EL 119 544-111 9DX 119 545-051	4 2	Spare Parts: Lens Reflector
		8GA 002 073-241	1	Accessories: 1x24V21W (P21W)
				
709 - 2024 (LK/LN2)	01/84->12/98	2JA 001 357-002 2JA 001 357-012	6 6	Interior light with switch Interior light without switch
		8GM 002 091-131	1	Accessories: 2x12V10W (K)
				





Manufacturer Model	Model year	Part no.	Pk.	Note
Mercedes-Benz				
1013 - 3850 (NG)				Headlight, with indicator, not suitable for headlight leveller, only spare parts available
1013 - 3850 (NG)	08/73->08/88			
1013, 1017, 1019				Spare Parts:
1213, 1217, 1219, 1222, 1225, 1228		9ES 113 919-001	1	Lens, left
		9ES 113 918-001	1	Lens, right
		9EV 113 436-005	10	Auxiliary lens for indicator light (amber)
		9GD 113 431-005	10	Seal for lens
1413, 1414, 1417, 1419, 1420, 1422, 1424, 1425, 1428, 1429		9DE 116 734-007	1	Reflector, left
		8GD 002 088-131	1	1x12V45/40W (R2)
		8GD 002 088-251	1	1x24V55/50W (R2)
		8GA 002 073-121	1	1x12V21W (P21W)
		8GA 002 073-241	1	1x24V21W (P21W)
1613, 1614, 1617, 1619, 1620, 1622, 1624, 1625, 1626, 1628, 1632, 1633, 1635, 1636, 1638, 1644		8GP 002 067-121	1	1x12V4W (T4W)
		8GP 002 067-241	1	1x24V4W (T4W)
1719				
1814				
1919, 1922, 1926, 1928, 1932, 1933, 1935, 1936, 1938, 1944				
2025, 2026, 2028, 2032, 2033, 2035, 2036				
2219, 2220, 2222, 2224, 2225, 2226, 2228, 2232, 2233, 2235, 2236, 2238, 2244				
2422, 2425, 2428, 2433, 2438, 2444				
2528, 2536				
2626, 2628, 2632, 2633, 2635, 2636, 2638, 2644				
3025, 3028, 3033, 3036, 3038				
3235, 3250				
3328, 3333, 3335, 3336, 3338				
3528, 3535, 3536, 3544				
3836, 3850				





Manufacturer Model	Model year	Part no.	Pk.	Note
Mercedes-Benz				
1013 - 3850 (NG)				H4 headlight, with indicator, not suitable for headlight leveller, only spare parts available
1013 - 3850 (NG)	08/73->08/88			
1013, 1017, 1019				Spare Parts:
1213, 1217, 1219, 1222, 1225, 1228		9ES 118 403-001	1	Lens, left
		9ES 118 402-001	1	Lens, right
1413, 1414, 1417, 1419, 1420, 1422, 1424, 1425, 1428, 1429		9EV 113 436-005	10	Auxiliary lens for indicator light (amber)
		9GD 113 431-005	10	Seal for lens
1613, 1614, 1617, 1619, 1620, 1622, 1624, 1625, 1626, 1628, 1632, 1633, 1635, 1636, 1638, 1644		9DE 118 423-001	1	Reflector, left
		9DE 118 424-001	1	Reflector, right
1719		8GJ 002 525-131	1	1x12V60/55W (H4)
1814		8GJ 002 525-251	1	1x24V75/70W (H4)
1919, 1922, 1926, 1928, 1932, 1933, 1935, 1936, 1938, 1944		8GA 002 073-121	1	1x12V21W (P21W)
2025, 2026, 2028, 2032, 2033, 2035, 2036		8GA 002 073-241	1	1x24V21W (P21W)
2219, 2220, 2222, 2224, 2225, 2226, 2228, 2232, 2233, 2235, 2236, 2238, 2244		8GP 002 067-121	1	1x12V4W (T4W)
2422, 2425, 2428, 2433, 2438, 2444		8GP 002 067-241	1	1x24V4W (T4W)
2528, 2536				
2626, 2628, 2632, 2633, 2635, 2636, 2638, 2644				
3025, 3028, 3033, 3036, 3038				
3228, 3235, 3250				
3328, 3333, 3335, 3336, 3338				
3528, 3535, 3536, 3544				
3836, 3850				
				
1013 - 3850 (NG)	08/73->08/88	2PF 961 167-021	2	Side light, for vehicles without external sun visor
				Spare Parts:
		9EL 137 241-001	4	Lens
		8GM 002 092-121	1	1x12V5W (C5W)
		8GM 002 092-241	1	1x24V5W (C5W)
				





Manufacturer Model	Model year	Part no.	Pk.	Note
Mercedes-Benz				
1013 - 3850 (NG)		2BM 002 847-011	1	Auxiliary indicator light, left
1013 - 3850 (NG)	08/73->08/88	2BM 002 847-021	1	Auxiliary indicator light, right
		9EL 115 830-001	5	Spare Parts: Lens
		8GA 002 073-121	1	Accessories: 1x12V21W (P21W)
		8GA 002 073-241	1	1x24V21W (P21W)
1013 - 3850 (NG)	08/73->08/88	2TJ 003 168-151	2	Clearance light, for side mounting
		8GM 002 092-121	1	Accessories: 1x12V5W (C5W)
		8GM 002 092-241	1	1x24V5W (C5W)





Manufacturer Model	Model year	Part no.	Pk.	Note
Mercedes-Benz				
1013 - 3850 (NG)		2SE 001 699-071	1	Combination rearlight, left, with licence plate light
1013 - 3850 (NG)	08/73->08/88	2SD 001 699-061	1	Combination rearlight, right, without licence plate light
1013, 1017, 1019				Spare Parts:
1213, 1217, 1219, 1222, 1225, 1228		9EL 109 139-001	2	Lens with screws
		9GT 074 132-001	10	Grommet
1413, 1414, 1417, 1419, 1420, 1422, 1424, 1425, 1428, 1429				Accessories:
1613, 1614, 1617, 1619, 1620, 1622, 1624, 1625, 1626, 1628, 1632, 1633, 1635, 1636, 1638, 1644		8GA 002 071-131	1	1x12V10W (R10W)
		8GA 002 071-251	1	1x24V10W (R10W)
		8GA 002 073-121	1	2x12V21W (P21W)
		8GA 002 073-241	1	2x24V21W (P21W)
1719				
1814				
1919, 1922, 1926, 1928, 1932, 1933, 1935, 1936, 1938, 1944				
2025, 2026, 2028, 2032, 2033, 2035, 2036				
2219, 2220, 2222, 2224, 2225, 2226, 2228, 2232, 2233, 2235, 2246, 2238, 2244				
2422, 2425, 2428, 2433, 2438, 2444				
2528, 2536				
2626, 2628, 2632, 2633, 2635, 2636, 2638, 2644				
3025, 3028, 3033, 3036, 3038				
3228, 3235, 3250				
3328, 3333, 3335, 3336, 3338				
3528, 3535, 3536, 3544				
3836, 3850				





Manufacturer Model	Model year	Part no.	Pk.	Note
Mercedes-Benz				
1013 - 3850 (NG)		2SE 003 167-031	1	Combination rearlight, left, with licence plate light
1013 - 3850 (NG)	08/73->08/88	2SD 003 167-021	1	Combination rearlight, right, without licence plate light
1013, 1017, 1019				Spare Parts:
1213, 1217, 1219, 1222, 1225, 1228		9EL 147 747-001	1	Lens with screws
		9GD 087 883-355	10	Seal
1413, 1414, 1417, 1419, 1420, 1422, 1424, 1425, 1428, 1429		8GA 002 071-131	1	1x12V10W (R10W)
		8GA 002 071-251	1	1x24V10W (R10W)
		8GA 002 073-121	1	2x12V21W (P21W)
		8GA 002 073-241	1	2x24V21W (P21W)
1613, 1614, 1617, 1619, 1620, 1622, 1624, 1625, 1626, 1628, 1632, 1633, 1635, 1636, 1638, 1644				
1719				
1814				
1919, 1922, 1926, 1928, 1932, 1933, 1935, 1936, 1938, 1944				
2025, 2026, 2028, 2032, 2033, 2035, 2036				
2219, 2220, 2222, 2224, 2225, 2226, 2228, 2232, 2233, 2235, 2246, 2238, 2244				
2422, 2428, 2425, 2433, 2438, 2444				
2528, 2536				
2626, 2628, 2632, 2633, 2635, 2636, 2638, 2644				
3025, 3028, 3033, 3036, 3038				
3228, 3235, 3250				
3328, 3333, 3335, 3336, 3338				
3528, 3535, 3536, 3544				
3836, 3850				
				
1013 - 3850 (NG)	08/73->08/88	2NE 003 236-001	1	Rear fog light
		9EL 119 544-001	4	Spare Parts: Lens
		9DX 119 545-011	2	Reflector
		8GA 002 073-121	1	Accessories: 1x12V21W (P21W)
		8GA 002 073-241	1	1x24V21W (P21W)
				





Manufacturer Model	Model year	Part no.	Pk.	Note
Mercedes-Benz				
1013 - 3850 (NG)	08/73->08/88	2ZR 003 236-051	1	Reverse light
1013 - 3850 (NG)		9EL 119 544-111	4	Spare Parts: Lens
		9DX 119 545-051	2	Reflector
		8GA 002 073-121	1	Accessories: 1x12V21W (P21W)
		8GA 002 073-241	1	1x24V21W (P21W)
				
1013 - 3850 (NG)	08/73->08/88	2JA 002 661-001	1	Interior light with switch
		9EL 116 607-005	12	Spare Parts: Lens
		8GA 002 073-121	1	Accessories: 2x12V21W (P21W)
		8GA 002 073-241	1	2x24V21W (P21W)
				
1013 - 3850 (NG)	08/73->08/88	2JA 001 357-012	6	Interior light without switch, for vehicles with sleeping cab
		8GM 002 091-131	1	Accessories: 2x12V10W (K)
		8GM 002 091-251	1	2x24V10W (K)
				



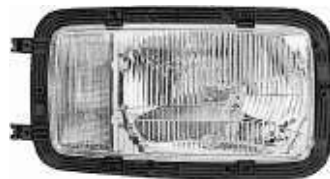

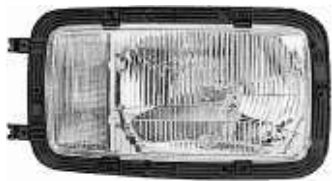

Manufacturer Model	Model year	Part no.	Pk.	Note
Mercedes-Benz				
1222 - 4850 (MK, SK)		1LH 002 658-451	1	Headlight, left, with indicator light, not suitable for headlight leveller
1222 - 4850 (MK, SK)	07/87->09/96	1LH 002 658-461	1	Headlight, right, with indicator light, not suitable for headlight leveller
1222, 1224, 1226, 1227, 1231, 1234				
1417, 1420, 1422, 1424, 1426, 1427, 1429				
1627		9ES 113 919-001	1	Spare Parts: Lens, left
		9ES 113 918-001	1	Lens, right
		9EV 113 436-005	10	Auxiliary lens for indicator light (amber)
		9GD 113 431-005	10	Seal for lens
		9DE 116 734-007	1	Reflector, left
1717, 1720, 1722, 1726, 1729, 1733, 1735, 1748		8GD 002 088-131	1	1x12V45/40W (R2)
		8GD 002 088-251	1	1x24V55/50W (R2)
1820, 1824, 1827, 1831, 1834, 1838, 1840, 1844, 1850, 1853		8GA 002 073-121	1	1x12V21W (P21W)
		8GA 002 073-241	1	1x24V21W (P21W)
		8GP 002 067-121	1	1x12V4W (T4W)
		8GP 002 067-241	1	1x24V4W (T4W)
1922, 1926, 1929, 1935, 1945, 1948				
2024, 2027, 2031, 2038, 2044, 2050, 2055				
2420, 2422, 2426, 2429, 2431, 2433, 2434, 2435, 2448				
2524, 2527, 2531, 2534, 2538, 2544, 2550, 2553				
2629, 2631, 2634, 2635, 2638, 2644, 2645, 2648, 2650, 2653				
3050, 3053				
3229, 3233, 3234, 3235, 3236, 3238, 3244, 3248, 3250, 3253, 3255				
3534, 3535, 3538, 3544, 3548, 3550, 3553				
4050				
4844, 4850				





Manufacturer Model	Model year	Part no.	Pk.	Note
Mercedes-Benz				
1222 - 4850 (MK, SK)		1LH 002 658-511	1	H4 headlight, left, with indicator light, not suitable for headlight leveller
1222 - 4850 (MK, SK)	07/87->09/96	1LH 002 658-521	1	H4 headlight, right, with indicator light, not suitable for headlight leveller
1222, 1224, 1226, 1227, 1231, 1234				
1417, 1420, 1422, 1424, 1426, 1427, 1429				H4 headlight, with indicator light, suitable for headlight leveller and holder for headlight leveller, only spare parts available
1627				
1717, 1720, 1722, 1726, 1729, 1733, 1735, 1748				
1820, 1824, 1827, 1831, 1834, 1838, 1840, 1844, 1850, 1853		9ES 118 403-001	1	Lens, left
		9ES 118 402-001	1	Lens, right
		9EV 113 436-005	10	Auxiliary lens for indicator light (amber)
		9GD 113 431-005	10	Seal for lens
		9DE 118 423-001	1	Reflector, left
		9DE 118 424-001	1	Reflector, right
		8GJ 002 525-131	1	1x12V60/55W (H4)
		8GJ 002 525-251	1	1x24V75/70W (H4)
		8GA 002 073-121	1	1x12V21W (P21W)
		8GA 002 073-241	1	1x24V21W (P21W)
		8GP 002 067-121	1	1x12V4W (T4W)
		8GP 002 067-241	1	1x24V4W (T4W)
1922, 1926, 1929, 1935, 1945, 1948				
2024, 2027, 2031, 2038, 2044, 2050, 2055				
2420, 2422, 2426, 2429, 2431, 2433, 2434, 2435, 2448				
2524, 2527, 2531, 2534, 2538, 2544, 2550, 2553				
2629, 2631, 2634, 2635, 2638, 2644, 2645, 2648, 2650, 2653				
3050, 3053				
3229, 3233, 3234, 3235, 3236, 3238, 3244, 3248, 3250, 3253, 3255				
3534, 3535, 3538, 3544, 3548, 3550 3553				
4050				
4844, 4850				
				
1222 - 4850 (MK, SK)	07/87->04/94	1NE 002 537-301	1	H3 fog light
For models with plastic bumpers only		9DF 117 504-007	2	Spare Parts: Reflector with lens
				
		1FE 125 510-011	1	Spare Parts: Light unit
		8GH 002 090-133	1	Accessories: 1x12V55W (H3)
		8GH 002 090-251	1	1x24V70W (H3)



Manufacturer Model	Model year	Part no.	Pk.	Note
Mercedes-Benz				
1222 - 4850 (MK, SK)		1NE 006 300-201	1	H3 fog light
1222 - 4850 (MK, SK)	05/94->09/96	1FE 006 300-191	1	H3 spotlight
For models with plastic bumpers only		8GH 002 090-133	1	Accessories: 1x12V55W (H3)
		8GH 002 090-251	1	1x24V70W (H3)
				
1222 - 4850 (MK, SK)	07/87->09/96	1FE 002 537-481	1	Xenon spotlight, with Xenon ballast 24V and gas discharge bulb D2S
For models with plastic bumpers only		1FE 152 896-011	1	Spare Parts: Light unit
		9AG 126 942-031	5	Lens-retaining rim
		5DV 007 810-171	1	Xenon ballast 24V
		8GS 007 949-101	1	1x35W (D2S)
				
1222 - 4850 (MK, SK)	07/87->09/96	2PF 961 167-021	2	Side light, for vehicles without external sun visor
		9EL 137 241-001	4	Spare Parts: Lens
		8GM 002 092-121	1	Accessories: 1x12V5W (C5W)
		8GM 002 092-241	1	1x24V5W (C5W)
				
1222 - 4850 (MK, SK)	05/94->09/96	2BM 006 692-011	1	Auxiliary indicator light, left
		2BM 006 692-021	1	Auxiliary indicator light, right
		8GA 002 073-241	1	Accessories: 1x24V21W (P21W)
				
1222 - 4850 (MK, SK)	07/87->09/96	2XS 004 237-291	1	Clearance light (white), left, for front mounting
		2XS 004 237-301	1	Clearance light (white), right, for front mounting
		8GA 002 071-121	1	Accessories: 1x12V5W (R5W)
		8GA 002 071-241	1	1x24V5W (R5W)
				





Manufacturer Model	Model year	Part no.	Pk.	Note
Mercedes-Benz				
1222 - 4850 (MK, SK)		2VD 005 300-551	1	Combination rearlight, left, with licence plate, rear fog, reverse, clearance light and lateral marker reflex-reflector (in the case of use in left-hand traffic, the number plate window of the black glare shield 9EL 134 301-011, order separately)
1222, 1224, 1226, 1227, 1231, 1234	07/87->10/94			
1417, 1420, 1422, 1424, 1426, 1427, 1429		2VD 005 300-581	1	Combination rearlight, right, with licence plate, rear fog, reverse, clearance light and lateral marker reflex-reflector Spare Parts:
1627				
1717, 1720, 1722, 1726, 1729, 1733, 1735, 1748		9EL 134 296-041	1	Lens with screws, left
		9EL 134 296-051	1	Lens with screws, right
1820, 1824, 1827, 1831, 1834, 1838, 1840, 1844, 1850, 1853		9EL 134 301-001	4	Lens for licence plate light
		9EL 134 301-011	1	Glare shield, black (order separately)
1922, 1926, 1929, 1935, 1945, 1948		8RA 003 326-011	20	Reflector (amber)
		8GA 002 071-131	1	3x12V10W (R10W)
		8GA 002 071-251	1	3x24V10W (R10W)
2024, 2027, 2031, 2038, 2044, 2050, 2055		8GA 002 073-121	1	4x12V21W (P21W)
		8GA 002 073-241	1	4x24V21W (P21W)
2420, 2422, 2426, 2429, 2431, 2433, 2434, 2435, 2448				
2524, 2527, 2531, 2534, 2538, 2544, 2550, 2553				
2629, 2631, 2634, 2635, 2638, 2644, 2645, 2648, 2650, 2653				
3050, 3053				
3229, 3233, 3234, 3235, 3236, 3238, 3244, 3248, 3250, 3253, 3255				
3534, 3535, 3538, 3544, 3548, 3550, 3553				
4050				
4844, 4850				











Mercedes-Benz - Neoplan







Manufacturer Model	Model year	Part no.	Pk.	Note
Mercedes-Benz				
1222 - 4850 (MK, SK)		2VD 007 500-091	1	Combination rearlight, left, with licence plate, rear fog, reverse, clearance light, with side-marker reflex-reflector and bulbs (in the case of use in left-hand traffic, the number plate window of the black glare shield 9EL 134 301-011, order separately)
1222 - 4850 (MK, SK)	11/94->09/96			
1222, 1224, 1226, 1227, 1231, 1234				
1417, 1420, 1422, 1424, 1426, 1427, 1429		2VD 007 500-201	1	Combination rearlight, right, with licence plate, rear fog, reverse, clearance light, with side-marker reflex-reflector and bulbs
1627				
1717, 1720, 1722, 1726, 1729, 1733, 1735, 1748		2VD 007 500-111	1	Combination rearlight, left, with licence plate, rear fog, reverse, clearance light, side-marker light, with side-marker reflex-reflector and bulbs (in the case of use in left-hand traffic, the number plate window of the black glare shield 9EL 134 301-011, order separately)
1820, 1824, 1827, 1831, 1834, 1838, 1840, 1844, 1850, 1853				
1922, 1926, 1929, 1935, 1945, 1948		2VD 007 500-221	1	Combination rearlight, right, with licence plate, rear fog, reverse, clearance light, side-marker light, with side-marker reflex-reflector and bulbs
2024, 2027, 2031, 2038, 2044, 2050, 2055				
2420, 2422, 2426, 2429, 2431, 2433, 2434, 2435, 2448		9EL 134 301-011	15	Accessories: Glare shield, black (order separately)
2524, 2527, 2531, 2534, 2538, 2544, 2550, 2553		9EL 134 296-041 9EL 134 296-051 9EL 146 838-001	1 1 2	Spare Parts: 1 Lens with screws, left 1 Lens with screws, right 2 Lens for side-marker light for -111/-221
2629, 2631, 2634, 2635, 2638, 2644, 2645, 2648, 2650, 2653		9EL 134 301-001 9GT 074 132-001 8RA 003 326-041 8GA 002 071-131 8GA 002 071-251 8GA 002 073-121 8GA 002 073-241	4 10 20 1 1 1 1	4 Lens for licence plate light 10 Grommet 20 Reflector (amber) for -091/-201 1 3x12V10W (R10W) 1 3x24V10W (R10W) 1 4x12V21W (P21W) 1 4x24V21W (P21W)
3050, 3053				
3229, 3233, 3234, 3235, 3236, 3238, 3244, 3248, 3250, 3253, 3255				
3534, 3535, 3538, 3544, 3548, 3550, 3553				
4050				
4844, 4850				
except vehicles with hazardous goods				
				
Neoplan				
Euroliner N 3316		1BL 007 834-007	8	DE@-H1 dipped-beam headlight
Euroliner N 3316	10/98->	9GH 145 943-001 9HD 155 239-001	24 12	Spare Parts: 24 Rubber cap (to be ordered and delivered separately) 12 Cap (plastic) with leads and plugs (to be ordered and delivered separately)
		1KL 007 834-027	8	DE@-H1 spotlight
		8GH 002 089-251	1	Spare Parts: 1x24V70W (H1)
				





Manufacturer Model	Model year	Part no.	Pk.	Note
Renault Trucks				
Magnum Magnum Vehicles with air suspension/ levelling system	06/01->	1LR 246 046-531	1	H1/H7 headlight, left, with indicator light, without headlight leveller, without lens cleaning system, with bulbs
		1LR 246 046-541	1	H1/H7 headlight, right, with indicator light, without headlight leveller, without lens cleaning system, with bulbs
		8GH 007 157-241	1	1x24V70W (H7)
		8GH 002 089-251	1	1x24V70W (H1)
	12/98->09/04	2VD 008 204-231	1	Combination rearlight, left, with licence plate, rear fog, reverse, clearance light, side-marker light, with reflex-reflector and marker reflex-reflector
		2VP 008 204-221	1	Combination rearlight, left/right, with rear fog, reverse, clearance light, side-marker light, with reflex-reflector and marker reflex-reflector
		9EL 152 889-001	1	Spare Parts: Lens with screws
		8GA 002 071-241	1	Accessories: 3x24V5W (R5W)
		8GA 002 073-241	1	4x24V21W (P21W)
		2VD 008 204-231	1	Combination rearlight, left, with licence plate, rear fog, reverse, clearance light, side-marker light, with reflex-reflector and marker reflex-reflector
Premium Premium		2VP 008 204-221	1	Combination rearlight, left/right, with rear fog, reverse, clearance light, side-marker light, with reflex-reflector and marker reflex-reflector
		9EL 152 889-001	1	Spare Parts: Lens with screws
		8GA 002 071-241	1	Accessories: 3x24V5W (R5W)
		8GA 002 073-241	1	4x24V21W (P21W)
Premium II Distribution Premium II Distribution	10/05->	1LL 247 010-311	1	H1/H7 headlight, left, with indicator light, without fog light, without headlight leveller, with bulbs
		1LL 247 010-321	1	H1/H7 headlight, right, with indicator light, without fog light, without headlight leveller, with bulbs
		1LL 247 010-331	1	H1/H7 headlight, left, with indicator light, with H3 fog light, without headlight leveller, with bulbs
		1LL 247 010-341	1	H1/H7 headlight, right, with indicator light, with H3 fog light, without headlight leveller, with bulbs
		8GH 007 157-231	1	Spare Parts: 1x24V70W (H7) Long Life
		8GH 002 089-251	1	1x24V70W (H1)
		8GH 002 090-251	1	1x24V70W (H3)
		8GA 006 841-241	1	1x24V21W (PY21W)
		8GP 003 594-251	1	1x24V5W (W5W)



Manufacturer Model	Model year	Part no.	Pk.	Note		
Renault Trucks						
Premium II Lander Premium II Lander 	10/06->	1LL 247 010-311	1	H1/H7 headlight, left, with indicator light, without fog light, without headlight leveller, with bulbs		
		1LL 247 010-321	1	H1/H7 headlight, right, with indicator light, without fog light, without headlight leveller, with bulbs		
		1LL 247 010-331	1	H1/H7 headlight, left, with indicator light, with H3 fog light, without headlight leveller, with bulbs		
		1LL 247 010-341	1	H1/H7 headlight, right, with indicator light, with H3 fog light, without headlight leveller, with bulbs		
		8GH 007 157-231	1	Spare Parts: 1x24V70W (H7) Long Life		
		8GH 002 089-251 8GH 002 090-251 8GA 006 841-241 8GP 003 594-251	1 1 1 1	1x24V70W (H1) 1x24V70W (H3) 1x24V21W (PY21W) 1x24V5W (W5W)		
Premium II Route Premium II Route 	10/05->	1LL 247 010-391	1	H1/H7 headlight, left, with indicator light, with H3 fog light, without headlight leveller, with bulbs		
		1LL 247 010-401	1	H1/H7 headlight, right, with indicator light, with H3 fog light, without headlight leveller, with bulbs		
		8GH 007 157-231	1	Spare Parts: 1x24V70W (H7) Long Life		
		8GH 002 089-251 8GH 002 090-251 8GA 006 841-241 8GP 003 594-251	1 1 1 1	1x24V70W (H1) 1x24V70W (H3) 1x24V21W (PY21W) 1x24V5W (W5W)		
		Scania				
		Older models Older models 		2SE 997 088-001	1	Combination rearlight with licence plate light
8GA 002 071-251 8GA 002 073-241	1 1			Accessories: 2x24V10W (R10W) 2x24V21W (P21W)		
G 82 - T 142 (series 2) G 82 - T 142 (series 2) 	05/80->03/88	2BE 003 649-011	1	Indicator-side light, left, with auxiliary indicator light		
		2BE 003 649-021	1	Indicator-side light, right, with auxiliary indicator light		
		9EL 123 209-005 9EL 123 210-005	5 5	Spare Parts: Lens, left Lens, right		
		8GA 002 071-241 8GA 002 073-241	1 1	Accessories: 1x24V5W (R5W) 1x24V21W (P21W)		







Manufacturer Model	Model year	Part no.	Pk.	Note
Scania				
P 93 - T 143 (series 3) P 93 - T 143 (series 3)	01/88->12/96			Indicator-side light, with auxiliary indicator light, side-marker light and reflector, only spare parts available
		9EL 151 127-001 9EL 151 128-001	5 5	Spare Parts: Body/lens, left Body/lens, right
		8GA 002 071-241 8GA 002 073-241	1 1	Accessories: 1x24V5W (R5W) 1x24V21W (P21W)
P 93 - T 143 (series 3) P 93, P 113 R 93, R 113, R 143 T 93, T 113, T 143	01/88->12/96	2VD 008 204-151	1	Combination rearlight, left, with licence plate, rear fog, reverse, clearance light, side-marker light, with reflex-reflector and marker reflex-reflector
		2VD 008 204-141	1	Combination rearlight, right, with licence plate, rear fog, reverse, clearance light, side-marker light, with reflex-reflector and marker reflex-reflector
		9EL 152 889-001	1	Spare Parts: Lens with screws
		8GA 002 071-241 8GA 002 073-241	1 1	Accessories: 3x24V5W (R5W) 4x24V21W (P21W)
P 93 - T 143 (series 3) P 93, P 113 R 93, R 113, R 143 T 93, T 113, T 143 Streamline	01/88->12/96	2VD 008 204-051	1	Combination rearlight, left, with licence plate, rear fog, reverse and clearance light, with reflex-reflector and centre plug
		2VP 008 204-041	1	Combination rearlight, left/right, with rear fog, reverse and clearance light, with reflex-reflector and centre plug
		2VD 008 204-071	1	Combination rearlight, left, with licence plate, rear fog, reverse, clearance light, side-marker light, with reflex-reflector, marker reflex-reflector and centre plug
		2VP 008 204-061	1	Combination rearlight, left/right, with rear fog, reverse, clearance light, side-marker light, with reflex-reflector, marker reflex-reflector and centre plug
		9EL 152 889-001	1	Spare Parts: Lens with screws
		8GA 002 071-241 8GA 002 073-241	1 1	Accessories: 3x24V5W (R5W) 4x24V21W (P21W)



Manufacturer Model	Model year	Part no.	Pk.	Note
Scania				
P 94 - T 164 (series 4) P 94 - T 164 (series 4) P 94, P 114, P 124 R 94, R 114, R 124, R 144, R 164 T 94, T 114, T 124, T 144, T 164	09/95->09/04	1LG 007 150-111 1LG 007 150-121 9ES 144 433-031 9ES 144 434-031 9DE 145 675-011 9DE 145 676-011 9EL 145 103-011 9EL 145 104-011 8KA 155 372-001 8GJ 002 525-251 8GA 002 071-271 8GA 002 073-251	1 1	H4 headlight, left, with indicator-side light (white) and suitable for electric headlight leveller H4 headlight, right, with indicator-side light (white) and suitable for electric headlight leveller Spare Parts: 1 Lens, left 1 Lens, right 1 Reflector, left 1 Reflector, right 1 Body/lens for indicator-side light, left 1 Body/lens for indicator-side light, right 1 Leitungssatz für Blink/Positionsleuchte 1 1x24V75/70W (H4) 1 2x24V10W (R10W) 1 Heavy Duty 1 2x24V21W (P21W) 1 Heavy Duty
P 94 - T 164 (series 4) P 94, P 114, P 124 R 94, R 114, R 124, R 144, R 164 T 94, T 114, T 124, T 144, T 164	09/95->09/04	2VD 008 205-011 2VD 008 205-021 9EL 152 884-001 8GA 002 071-241 8GA 002 071-251 8GA 002 073-241	1 1	Combination rearlight, left, with licence plate, rear fog, reverse, clearance light, side-marker light, with reflex-reflector and marker reflex-reflector Combination rearlight, right, with licence plate, rear fog, reverse, clearance light, side-marker light, with reflex-reflector and marker reflex-reflector Spare Parts: 1 Lens with screws Accessories: 1 3x24V5W (R5W) 1 1x24V10W (R10W) 1 4x24V21W (P21W)
P 230 - T 470 P 230 - T 470 (series P, G, R, T) P 230, P 270, P 310, P 340, P 360, P 380, P 400, P 420 G 230, G 400 R 340, R 380, R 400, R 420, R 470, R 500, R 580, R 620 T 470	03/04->	1LG 007 150-111 1LG 007 150-121 9ES 144 433-031 9ES 144 434-031 9DE 145 675-011 9DE 145 676-011 9EL 145 103-011 9EL 145 104-011 8KA 155 372-001 8GJ 002 525-251 8GA 002 071-271 8GA 002 073-251	1 1	H4 headlight, left, with indicator-side light (white) and suitable for electric headlight leveller H4 headlight, right, with indicator-side light (white) and suitable for electric headlight leveller Spare Parts: 1 Lens, left 1 Lens, right 1 Reflector, left 1 Reflector, right 1 Body/lens for indicator-side light, left 1 Body/lens for indicator-side light, right 1 Leitungssatz für Blink/Positionsleuchte 1 1x24V75/70W (H4) 1 2x24V10W (R10W) 1 Heavy Duty 1 2x24V21W (P21W) 1 Heavy Duty







Manufacturer Model	Model year	Part no.	Pk.	Note	
Scania					
P 230 - T 470 P 230 - T 470 (series P, G, R, T) P 230, P 270, P 310, P 340, P 380, P 420 G 230 R 340, R 380, R 420, R 470, R 500, R 580, R 620 T 470	03/04->09/06	2VD 008 205-011	1	Combination rearlight, left, with licence plate, rear fog, reverse, clearance light, side-marker light, with reflex-reflector and marker reflex-reflector	
		2VD 008 205-021	1		Combination rearlight, right, with licence plate, rear fog, reverse, clearance light, side-marker light, with reflex-reflector and marker reflex-reflector
		9EL 152 884-001	1	Spare Parts: Lens with screws	
		8GA 002 071-241 8GA 002 071-251 8GA 002 073-241	1 1 1	Accessories: 3x24V5W (R5W) 1x24V10W (R10W) 4x24V21W (P21W)	
	03/04->	2KA 003 389-061	2	Licence plate light	
		9BG 121 587-031	2	Spare Parts: Body/lens with screw	
		8GA 002 071-251	1	Accessories: 1x24V10W (R10W)	
	Volvo				
	F 10 - F 16 F 10, F 12, F 16	10/87->	1LG 004 679-051	1	H4 headlight
			8GJ 002 525-251	1	Spare Parts: 1x24V75/70W (H4)
	08/77->09/87	9EL 119 097-021 9EL 119 098-021	1	Indicator-side light, only spare parts available	
			1		Spare Parts: Lens, left Lens, right
		8GA 002 071-241 8GA 002 073-241	1	Accessories: 1x24V5W (R5W) 1x24V21W (P21W)	
			1		
	LHT 11				



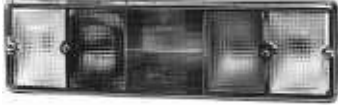



Volvo



Manufacturer Model	Model year	Part no.	Pk.	Note
Volvo				
F 10 - F 16 F 10, F 12, F 16 	10/87->07/93	2SL 005 883-031	1	Combination rearlight, left, with licence plate, rear fog and reverse light
		2SL 005 883-041	1	Combination rearlight, right, with licence plate, rear fog and reverse light
		2SK 005 883-011	1	Combination rearlight, left, with rear fog and reverse light
		2SK 005 883-021	1	Combination rearlight, right, with rear fog and reverse light
		9EL 135 548-001	1	Spare Parts: Lens
		8GA 002 071-241 8GA 002 073-241	1 1	Accessories: 2x24V5W (R5W) 4x24V21W (P21W)
FH FH Vehicles with air suspension/ levelling system 	09/08->	1LL 010 478-131	1	DE@-H7 headlight, left, with indicator light, without headlight leveller, with bulbs
		1LL 010 478-141	1	DE@-H7 headlight, right, with indicator light, without headlight leveller, with bulbs
		8GH 007 157-231	1	Spare Parts: 2x24V70W (H7) Long Life
		8GA 006 841-241	1	1x24V21W (PY21W)
FH 	09/08->	5DV 008 856-001	1	Ballast unit
FH 	09/08->	5DD 008 319-501	1	Ignitor, gas discharge bulb
FH 12, FH 16 FH 12, FH 16 	10/93->09/97	1LG 006 898-051	1	H4 headlight
		8GJ 002 525-251	1	Spare Parts: 1x24V75/70W (H4)





Manufacturer Model	Model year	Part no.	Pk.	Note
Volvo				
FH 12, FH 16		1LG 006 898-091	1	H4 headlight
FH 12	10/97->12/01	8GJ 002 525-251	1	Spare Parts: 1x24V75/70W (H4)
FH 16	10/97->12/01			
				
FH 12, FH 16	10/93->12/01	1FE 006 300-251	1	H3 spotlight
		1FE 138 520-011	1	Spare Parts: Light unit
		8GH 002 090-251	1	Accessories: 1x24V70W (H3)
				
FH 12, FH 16	10/93->04/05	2VD 008 205-051	1	Combination rearlight, left, with licence plate, rear fog, reverse, clearance light, side-marker light, with reflex-reflector and marker reflex-reflector
		2VD 008 205-041	1	Combination rearlight, right, with licence plate, rear fog, reverse, clearance light, side-marker light, with reflex-reflector and marker reflex-reflector
		2VP 008 205-031	1	Combination rearlight, left/right, with rear fog, reverse, clearance light, side-marker light, with reflex-reflector and marker reflex-reflector
		9EL 152 884-001	1	Spare Parts: Lens with screws
		8GA 002 071-241	1	Accessories: 3x24V5W (R5W)
		8GA 002 071-251	1	2X24V10W (R10W)
		8GA 002 073-241	1	4x24V21W (P21W)
				
FL		2VD 008 205-051	1	Combination rearlight, left, with licence plate, rear fog, reverse, clearance light, side-marker light, with reflex-reflector and marker reflex-reflector
FL	03/00->	2VD 008 205-041	1	Combination rearlight, right, with licence plate, rear fog, reverse, clearance light, side-marker light, with reflex-reflector and marker reflex-reflector
		2VP 008 205-031	1	Combination rearlight, left/right, with rear fog, reverse, clearance light, side-marker light, with reflex-reflector and marker reflex-reflector
		9EL 152 884-001	1	Spare Parts: Lens with screws
		8GA 002 071-241	1	Accessories: 3x24V5W (R5W)
		8GA 002 071-251	1	2X24V10W (R10W)
		8GA 002 073-241	1	4x24V21W (P21W)
				





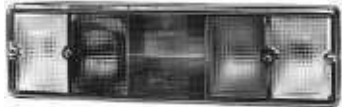

Volvo

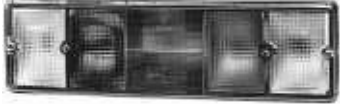

Manufacturer Model	Model year	Part no.	Pk.	Note
Volvo				
FL 4, FL 6 FL 4, FL 6	->10/90	1LG 004 679-051 8GJ 002 525-251	1 1	H4 headlight Spare Parts: 1x24V75/70W (H4)
				
FL 4, FL 6	10/85->	2SL 005 883-031 2SL 005 883-041 2SK 005 883-011 2SK 005 883-021 9EL 135 548-001 8GA 002 071-241 8GA 002 073-241	1 1 1 1 1 1 1	Combination rearlight, left, with licence plate, rear fog and reverse light Combination rearlight, right, with licence plate, rear fog and reverse light Combination rearlight, left, with rear fog and reverse light Combination rearlight, right, with rear fog and reverse light Spare Parts: Lens Accessories: 2x24V5W (R5W) 4x24V21W (P21W)
				
FL 7 - FL 12 FL 7, FL 10 FL 12	10/85->	1LG 004 679-051 8GJ 002 525-251	1 1	H4 headlight Spare Parts: 1x24V75/70W (H4)
				
FL 7, FL 10	10/85->07/93	2SL 005 883-031 2SL 005 883-041 2SK 005 883-011 2SK 005 883-021 9EL 135 548-001 8GA 002 071-241 8GA 002 073-241	1 1 1 1 1 1 1	Combination rearlight, left, with licence plate, rear fog and reverse light Combination rearlight, right, with licence plate, rear fog and reverse light Combination rearlight, left, with rear fog and reverse light Combination rearlight, right, with rear fog and reverse light Spare Parts: Lens Accessories: 2x24V5W (R5W) 4x24V21W (P21W)
				







Manufacturer Model	Model year	Part no.	Pk.	Note
Volvo				
FLC FLC	09/96->09/00	 2SL 005 883-031 2SL 005 883-041 2SK 005 883-011 2SK 005 883-021 9EL 135 548-001 8GA 002 071-241 8GA 002 073-241	1 1 1 1 1 1 1	Combination rearlight, left, with licence plate, rear fog and reverse light Combination rearlight, right, with licence plate, rear fog and reverse light Combination rearlight, left, with rear fog and reverse light Combination rearlight, right, with rear fog and reverse light Spare Parts: Lens Accessories: 2x24V5W (R5W) 4x24V21W (P21W)
FM FM Vehicles with air suspension/levelling system	06/10->	 1LL 010 478-131 1LL 010 478-141 8GH 007 157-231 8GA 006 841-241	1 1 1 1	DE@-H7 headlight, left, with indicator light, without headlight leveller, with bulbs DE@-H7 headlight, right, with indicator light, without headlight leveller, with bulbs Spare Parts: 2x24V70W (H7) Long Life 1x24V21W (PY21W)
FM	06/10->		1	Ballast unit
FM	06/10->		1	Ignitor, gas discharge bulb
FM 7 FM 7	10/98->12/01	 1LG 006 898-091 8GJ 002 525-251	1 1	H4 headlight Spare Parts: 1x24V75/70W (H4)





Volvo



Manufacturer Model	Model year	Part no.	Pk.	Note
Volvo				
FM 7 FM 7	10/98->12/01	1FE 006 300-251 1FE 138 520-011 8GH 002 090-251	1 1 1	H3 spotlight Spare Parts: Light unit Accessories: 1x24V70W (H3)
				
FM 7	10/98->12/01	2VD 008 205-051 2VD 008 205-041 2VP 008 205-031 9EL 152 884-001 8GA 002 071-241 8GA 002 071-251 8GA 002 073-241	1 1 1 1 1 1 1	Combination rearlight, left, with licence plate, rear fog, reverse, clearance light, side-marker light, with reflex-reflector and marker reflex-reflector Combination rearlight, right, with licence plate, rear fog, reverse, clearance light, side-marker light, with reflex-reflector and marker reflex-reflector Combination rearlight, left/right, with rear fog, reverse, clearance light, side-marker light, with reflex-reflector and marker reflex-reflector Spare Parts: Lens with screws Accessories: 3x24V5W (R5W) 2X24V10W (R10W) 4x24V21W (P21W)
				
FM 9 FM 9	12/01->09/05	2VD 008 205-051 2VD 008 205-041 2VP 008 205-031 9EL 152 884-001 8GA 002 071-241 8GA 002 071-251 8GA 002 073-241	1 1 1 1 1 1 1	Combination rearlight, left, with licence plate, rear fog, reverse, clearance light, side-marker light, with reflex-reflector and marker reflex-reflector Combination rearlight, right, with licence plate, rear fog, reverse, clearance light, side-marker light, with reflex-reflector and marker reflex-reflector Combination rearlight, left/right, with rear fog, reverse, clearance light, side-marker light, with reflex-reflector and marker reflex-reflector Spare Parts: Lens with screws Accessories: 3x24V5W (R5W) 2X24V10W (R10W) 4x24V21W (P21W)
				
FM 12 FM 12	10/98->12/01	1LG 006 898-091 8GJ 002 525-251	1 1	H4 headlight Spare Parts: 1x24V75/70W (H4)
				

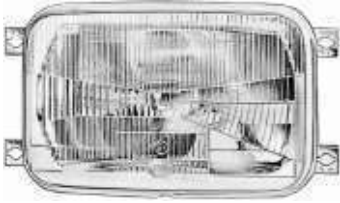
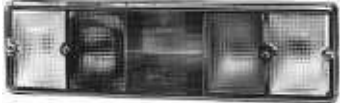

Manufacturer Model	Model year	Part no.	Pk.	Note
Volvo				
FM 12 FM 12	10/98->12/01	1FE 006 300-251 1FE 138 520-011 8GH 002 090-251	1 1 1	H3 spotlight Spare Parts: Light unit Accessories: 1x24V70W (H3)
				
FM 12	10/98->09/05	2VD 008 205-051 2VD 008 205-041 2VP 008 205-031 9EL 152 884-001 8GA 002 071-241 8GA 002 071-251 8GA 002 073-241	1 1 1 1 1 1 1	Combination rearlight, left, with licence plate, rear fog, reverse, clearance light, side-marker light, with reflex-reflector and marker reflex-reflector Combination rearlight, right, with licence plate, rear fog, reverse, clearance light, side-marker light, with reflex-reflector and marker reflex-reflector Combination rearlight, left/right, with rear fog, reverse, clearance light, side-marker light, with reflex-reflector and marker reflex-reflector Spare Parts: Lens with screws Accessories: 3x24V5W (R5W) 2x24V10W (R10W) 4x24V21W (P21W)
				
FS 7 FS 7		1LG 004 679-051 8GJ 002 525-251	1 1	H4 headlight Spare Parts: 1x24V75/70W (H4)
				
FS 7		2SL 005 883-031 2SL 005 883-041 2SK 005 883-011 2SK 005 883-021 9EL 135 548-001 8GA 002 071-241 8GA 002 073-241	1 1 1 1 1 1 1	Combination rearlight, left, with licence plate, rear fog and reverse light Combination rearlight, right, with licence plate, rear fog and reverse light Combination rearlight, left, with rear fog and reverse light Combination rearlight, right, with rear fog and reverse light Spare Parts: Lens Accessories: 2x24V5W (R5W) 4x24V21W (P21W)
				

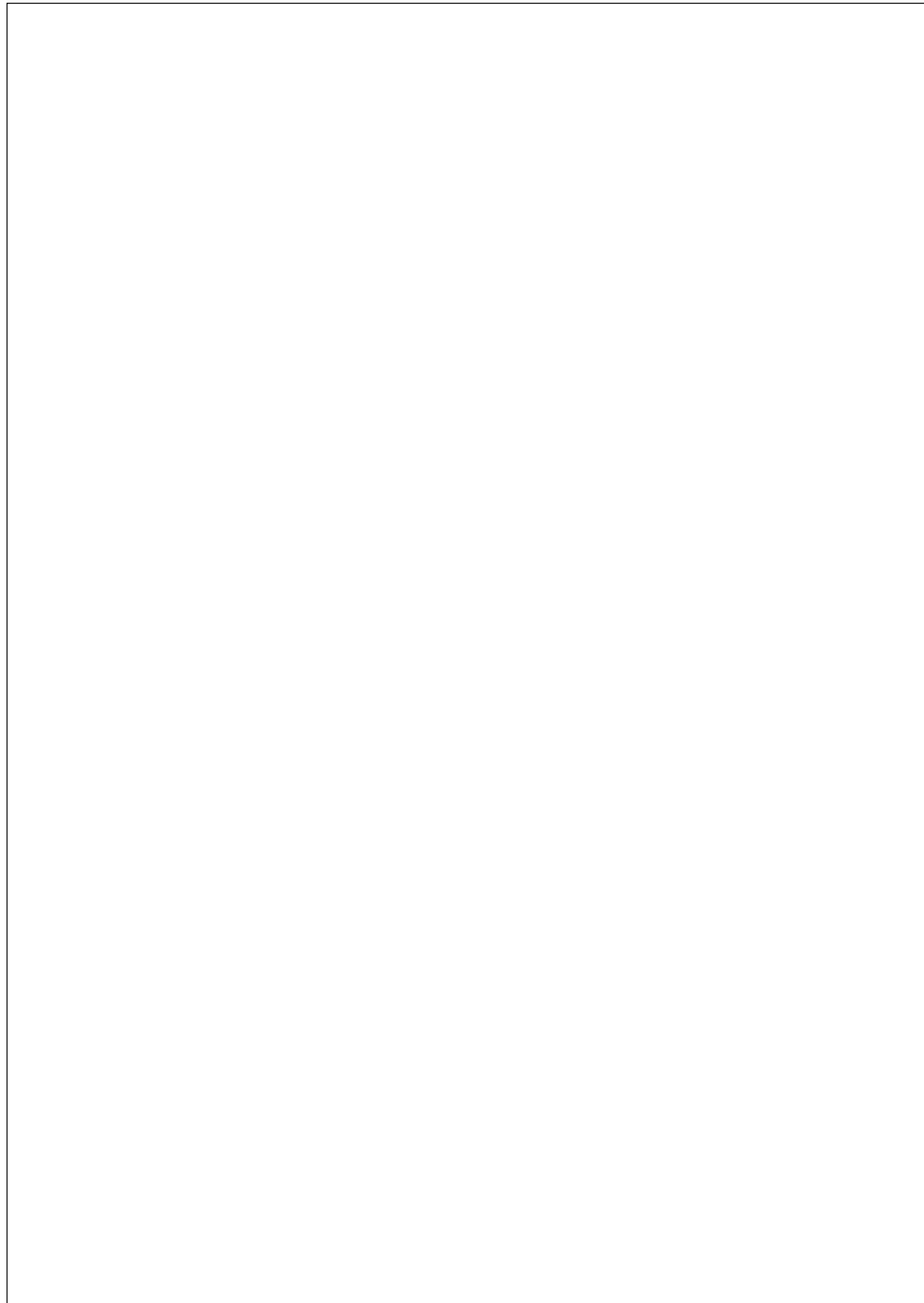



Fog Lights, Driving Lights, Headlights, Work Lights and Search Lights



Information on LED technology headlights

4.02

Information on work lights

4.02

Fog lights and driving lights

4.03-4.24

Accessories for fog- and driving lights

4.25

Built-in headlights

4.26-4.44

External-fitting headlights

4.45-4.46

"5760" light series

4.47-4.49

"Oval 100 / 120" light series

4.50-4.62

"Module 120" light series

4.63-4.65

"Module 6213" light series

4.65-4.69

Work lights

4.71-4.121

Accessories for work lights

4.122-4.125

Searchlights

4.126

"7145" light series

4.69-4.70

Instruction regarding LED technology headlights

In connection with these low power ratings, which differ significantly from those of a bulb-based version, problems arise with indicator failure control on various traction vehicles, because further light functions are detected by some traction vehicles. This is a comfort function of the vehicle which is not required by law and does not release the driver from its duty to visually check the lighting system. The failure control of an LED headlight demanded by law within the scope of ECE R48 has to be ensured in the vehicle by suitable measures. The customer is responsible for this.

Here as well, faulty diagnosis may occur due to the small power (instrument panel in the driver's cab shows lamp failure although function is OK).

The functional ability of these light failure checks can only be established by the vehicle manufacturer.

Operation of the LED headlight with alternating voltage or clocked direct voltage is not permitted!

The individual functions of a headlight must only be operated with an onboard fuse of max. 10A (vehicle-specific 5A).

In the case of onboard current limitation with the values specified above by the onboard control unit an additional fuse for the headlight is not required.

Why work lights?

**Working at night -
no problem with the right headlights.**

Special headlight types have been developed for this purpose:

Low-beam headlights and spotlights:
for illuminating the road in road traffic.

Fog lights:

for poor visibility conditions in road traffic.

Work lights:

for the illumination of a working area near the vehicle and away from public road traffic.



Low beam

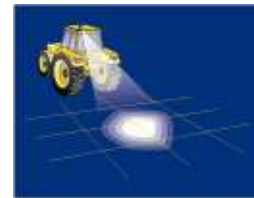

Spotlight



Fog light

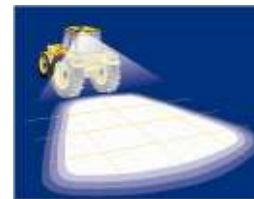

Work light

At the mounting height typical for work lighting (2.50 m), only worklights provide sufficient illumination of the working area. Standard vehicle lighting is nowhere near good enough! Outstanding features of a good worklight include the homogeneous illumination of as large an area as possible and a soft transition at the edge.

Active safety through proper illumination!

It's not only the selection of the correct type of headlight that is decisive for the choice of optimum worklight, but its correct positioning on the vehicle, too. Worklights shine at an angle to the surface they are illuminating. This means that even small changes in the angle of inclination and the mounting height have a great influence on the illumination of the working area. For large-surface illumination, the higher the mounting position the better.



low
mounting position



high
mounting position

Legal notes:

According to FMVSS § 52 (7) [Germany], all multi-track vehicles may be equipped with one or more worklights.

Worklights must not be used when these vehicles are being driven on public roads, only when they are at a standstill, e.g. during loading and unloading.

Exceptions to this are made for vehicles used for constructing, maintaining or cleaning the roads or for waste disposal vehicles, if the action of driving is part of a working process.

Worklights may only be switched on as long as they do not dazzle other road users.

Worklights must be able to be switched on independently of all other headlights or lights, e.g. joint circuitry with the reverse light is not permitted. Hella provides special reversing spotlights for this purpose.

There are no special approval regulations, e.g. according to ECE or EC, since worklights may only be used when driving away from public roads.

For surface/flush mounting

DynaView Evo 2

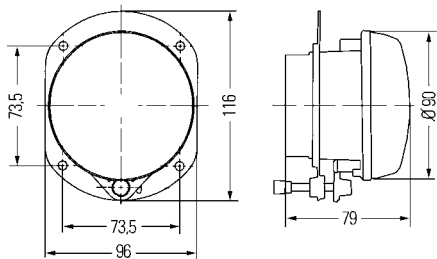

Part no.	Pk.	
1N0 009 295-801	1	H7 fog-/tracking headlight set with bracket for surface mounting, 12V bulbs and tracking headlight unit
5DF 009 244-007	24	Spare parts: Tracking headlight unit
8KB 163 160-801	1	Lead set to the electric connection of the tracking headlight unit
8GH 007 157-121	1	H7 bulb, 12V55W
1N0 009 295-011	1	H7-fog-/tracking headlight with bracket for surface mounting and 12V bulb, left
1N0 009 295-021	1	right
1N0 009 295-031	1	H7 fog-/tracking headlight with supporting frame for flush mounting and 12V bulb, left
1N0 009 295-037	36	
1N0 009 295-041	1	right
1N0 009 295-047	36	
1N0 009 295-057	36	H7 fog-/tracking headlight with supporting frame for flush mounting and 24V bulb, left
1N0 009 295-067	36	right
5DF 009 244-007	24	Spare parts/Accessories: Tracking headlight unit
8KB 163 160-801	1	Lead set to the electric connection of the tracking headlight unit
8GH 007 157-121	1	H7 bulb, 12V55W
8GH 007 157-241	1	24V70W

For upright mounting

Comet FF® 200

Ref. 37.5: 1F4 007 893-811/-841/021/-081/-191

Ref. 17.5: 1F4 007 893-921/-911/201/-241

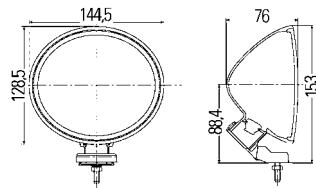

Part no.	Pk.	
1N4 007 893-821	1	H3 fog light set with 12V bulbs, relay, lead set, on/off switch, basalt grey body
1N4 007 893-001	1	H3 fog light with 12V bulb, ivory body
1F4 007 893-811	1	H3 driving light set with 12V bulbs, relay, lead set, on/off switch and ivory body
1F4 007 893-841	1	with basalt grey body
1F4 007 893-021	1	H3 driving light with 12V bulb, and ivory body
1F4 007 893-081	1	with basalt grey body
1F4 007 893-191	1	H3 driving light without 12V bulb, with chrome-plated body
1F4 007 893-921	1	H3 driving light set with 12V bulbs, relay, lead set and on/off switch, and ivory body
1F4 007 893-911	1	with basalt grey body
1F4 007 893-201	1	H3 driving light without 12V bulb, with chrome-plated body
1F4 007 893-241	1	with blue lens and basalt grey body
Spare parts/Accessories:		
1N4 149 531-011	1	Light unit with 12V bulb, for -821/-001
1F4 149 537-011	1	for -811/-841/-021/-081
1F4 160 300-011	1	for -191
1F4 160 302-011	1	for -201
1F4 162 883-011	1	for -241
4RA 965 400-001	1	Normally-open relay for -811/-821/-841/-921/-911
6EH 007 946-001	1	Switch for -811/-821/-841/-921/-911
8GH 002 090-133	1	H3 bulb, 12V55W

Comet 200 Xenon

With antracit body, silver coloured rim.

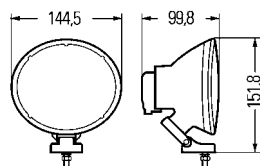

Part no.	Pk.	
1F4 007 893-871	1	Xenon driving light set with gas discharge bulbs, 12V ballast unit, lead set and relay
1F4 007 893-141	1	Xenon driving light, with gas discharge bulb, 12V ballast unit, lead set and relay
Spare parts/Accessories:		
1F4 157 022-011	1	Light unit
5DV 007 760-631	1	Ballast unit, 12V
8GS 007 949-101	1	D2S gas discharge bulb, 35W

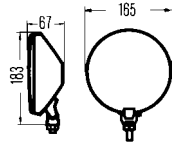

For upright mounting

Classic 160

Chrome-plated body.

Part no.	Pk.	
1N4 002 608-021	1	H3 fog light, 12V
1F4 002 608-001	1	H3 driving light, 12V
Accessories:		
8GH 002 090-133	1	H3 bulb, 12V55W

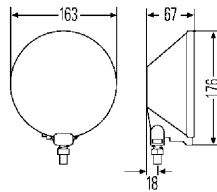

Comet 500

Black plastic body.

Part no.	Pk.	
1N4 005 750-801	1	H3 fog light set, 12V, with bulbs, relay with lead and on/off switch
1N4 005 750-001	1	H3 fog light, 12V/24V, without bulb
1N4 005 750-041	1	12V, with bulb, yellow light
1F4 005 750-811	1	Ref. 37,5 H3 driving light set, 12V, with bulbs
1F4 005 750-301	1	H3 driving light, 12V, with bulb
1F4 005 750-871	1	Ref. 17,5 H3 driving light set, 12V, with bulbs
1F4 005 750-071	1	H3 driving light, 12V, without bulb
Spare parts/Accessories:		
1N4 135 224-011	1	Light unit for -801/-001
1F4 135 230-011	1	Light unit for -811/-301
6EG 001 567-041	1	On/off switch for -801
8GH 002 090-133	1	H3 bulb, 12V55W
8GH 002 090-251	1	H3 bulb, 24V70W

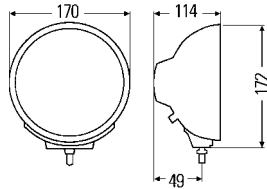

For upright mounting

Luminator Compact Celis®

Die-cast zinc body, rim and bracket.
Lens with clear-glass look.

Part no.	Pk.	
1F1 009 094-041	1	Ref. 37,5 H1 main light, 12V/24V, with CELIS® position light incl. LEDs, without bulb, black
1F1 009 094-051	1	Ref. 37.5 H1 driving-beam light, 12V/24V, with CELIS® position light incl. LEDs, without bulb, chrome-plated
1F1 009 094-091	1	Ref. 17.5 H1 driving-beam light, 12V/24V, with CELIS® position light incl. LEDs, without bulb, chrome-plated
		Spare parts/Accessories:
1F1 161 825-021	1	Light unit for -041/-051
1F1 161 825-041	1	for -091
9AG 161 844-011	1	Lens-retaining rim, black
9AG 161 844-021	1	chrome-plated
8GH 002 089-133	1	H1 bulb, 12V55W
8GH 002 089-251	1	24V70W

For upright mounting

Luminator Compact

Die-cast zinc body, rim and bracket.
Lens with clear-glass look.

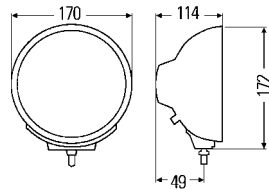

Part no.	Pk.	
1N3 009 094-001	1	H7 fog light, 12V/24V, black
1F3 009 094-021	1	Ref. 37.5 H1 driving-beam light, 12V/24V black
1F3 009 094-061	1	Ref. 17.5 H1 driving-beam light, 12V/24V, black
1N3 009 094-011	1	H7 fog light, 12V/24V, chrome plated
1F3 009 094-031	1	Ref. 37,5 H1 driving-beam light, 12V/24V, chrome plated
1F3 009 094-171	1	H1 driving-beam light, 12V/24V, with blue lens, chrome plated
1F3 009 094-071	1	Ref. 17,5 H1 driving-beam light, 12V/24V, with blue lens, chrome plated
Spare parts/Accessories:		
1N3 161 825-001	1	Light unit for -001/-011
1F3 161 825-011	1	for -021/-031
1F3 161 825-031	1	for -061/-071
1F3 161 825-081	1	for -171
9AG 161 844-011	1	Lens-retaining rim, black
9AG 161 844-021	1	chrome-plated
8GH 007 157-121	1	H7 bulb, 12V55W
8GH 007 157-241	1	24V70W
8GH 002 089-133	1	H1 bulb, 12V55W
8GH 002 089-251	1	24V70W

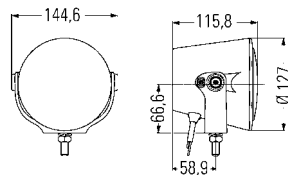

Luminator X Xenon

Black die-cast zinc body, chrome-plated rim.
Lens with clear-glass look.

Part no.	Pk.	
1F0 010 186-001	1	Xenon main-beam headlight with gas discharge bulb and 12V ballast unit integrated into body
1F0 172 787-011	1	Spare parts: Light unit
9AG 172 638-001	1	Lens-retaining rim
8GS 009 028-021	1	D1S gas discharge bulb, 35W

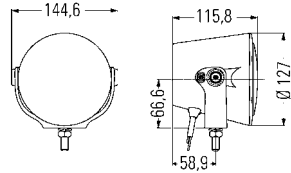

For upright mounting

Luminator X Halogen

Black die-cast aluminium body and lens-retaining rim, lens with clear-glass look.

Part no.	Pk.	
1F0 010 186-201	1	H1 driving light with 12V bulb
8GH 002 089-133	1	Spare parts: H1 bulb, 12V

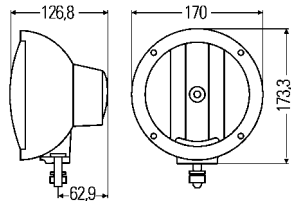

Luminator Compact Xenon

Black die-cast zinc body and bracket. Lens with clear-glass look.

Part no.	Pk.	
1F3 009 094-142	1	Xenon driving-beam light with black rim, gas discharge bulb and 12V ballast unit

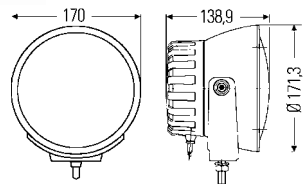

1F3 009 094-311	1	Xenon driving light with chrome-plated rim, gas discharge bulb and 12V ballast unit integrated into body
1F3 161 825-071	1	Spare parts: Light unit
9AG 161 844-011	1	Lens-retaining rim, black
9AG 161 844-031	1	chrome-plated
8GS 009 028-021	1	D1S gas discharge bulb, 35W

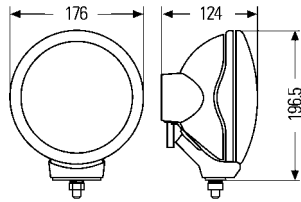

For upright mounting

Rallye 1000 Xenon

Black/red body. Lens with clear-glass look.

Part no.	Pk.	
1F5 008 273-041	1	Xenon main-beam headlight with gas discharge bulb and 12V ballast unit
1F5 154 875-011	1	Spare parts: Light unit
5DV 007 760-631	1	Ballast unit
8GS 007 949-101	1	D2S gas discharge bulb, 35W

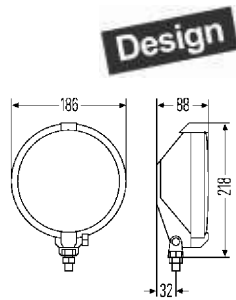

Rallye 1000

Black plastic body and lens-retaining rim.
with black lens (Colour-Design), without bulb

Part no.	Pk.	
1F7 004 700-431	1	H2 driving-beam light, 12V
8GH 002 857-121	1	Accessories: H2 bulb, 12V55W

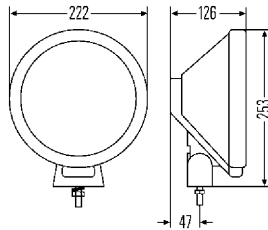

For upright mounting

Rallye 3000

Black plastic body and rim.

Part no.	Pk.	
1N8 006 800-001	1	H3 fog light, 12V/24V
1F8 006 800-191	1	Ref. 37.5 H1 driving-beam light, 12V/24V, with position light
1F8 006 800-301	1	lens with clear-glass look, without position light
1F8 006 800-311	1	lens with clear-glass look, with position light
1F8 006 800-361	1	Ref. 17.5 H1 driving-beam light, 12V/24V, lens with clear-glass look, without position light
1F8 006 800-341	1	lens with clear-glass look, with position light
1F8 006 800-401	1	with lens with clear-glass look and CELIS® position light incl. LEDs
Spare parts/Accessories:		
Light unit		
1N8 142 350-011	1	for -001
1F8 147 077-011	1	for -191
1F8 162 872-011	1	for -301
1F8 162 873-011	1	for -311
1F8 165 941-011	1	for -341
1F8 165 943-011	1	for -361
1F8 161 326-011	1	for -401
Lens-retaining rim		
9AG 141 819-001	6	for -191
9AG 141 819-041	1	for -301/-311/-341/-361
9AG 162 938-001	1	for -401
8HG 116 741-801	1	Bracket for two-point fixing (2 pcs.)
8KA 002 309-811	1	Lead set
Lead set with LED control electronics		
8KB 161 334-007	5	for -401
H3 bulb,		
8GH 002 090-133	1	12V55W
8GH 002 090-251	1	24V70W
H1 bulb,		
8GH 002 089-133	1	12V55W
8GH 002 089-251	1	24V70W
W5W bulb,		
8GP 003 594-121	1	12V5W
8GP 003 594-251	1	24V5W

For upright mounting

Rallye 3000 Blue

Black plastic body,
silver lens-retaining rim with blue stripes.
With blue lens.

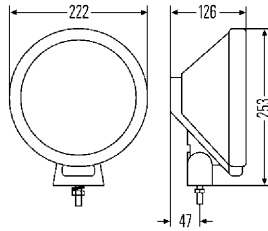

Part no.	Pk.	
1F8 006 800-221	1	Ref. 37.5 H1 driving-beam light, 12V/24V, with position light
1F8 006 800-321	1	lens with clear-glass look, with position light
1F8 006 800-331	1	Ref. 17.5 H1 driving-beam light, 12V/24V, lens with clear-glass look, without position light
1F8 006 800-351	1	lens with clear-glass look, with position light
Spare parts/Accessories:		
1F8 157 042-011	1	Light unit for -221
1F8 162 874-011	1	for -321
1F8 165 940-011	1	for -331
1F8 165 942-011	1	for -351
9AG 141 819-011	6	Lens-retaining rim for -221/-321
9AG 141 819-041	1	for -331/-351
8HG 116 741-801	1	Bracket for two-point fixing (2 pcs.)
8KA 002 309-811	1	Lead set
8GH 002 089-133	1	H1 bulb, 12V/55W
8GH 002 089-251	1	24V/70W
8GP 003 594-121	1	W5W bulb, 12V/5W
8GP 003 594-251	1	24V/5W

For upright mounting

Rallye 3003

Black body.

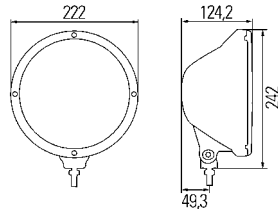

Part no.	Pk.	
1F8 009 797-321	1	Ref. 50 H1 driving light, 12V/24V, lens with clear-glass look, with position light, silver lens-retaining rim
1F8 009 797-341	1	chrome-plated rim
1F8 009 797-331	1	Ref. 50 H1 driving light, 12V/24V, blue lens with clear-glass look, with position light, silver lens-retaining rim
1F8 009 797-351	1	chrome-plated rim
1F8 009 797-021	1	Ref. 37.5 H1 driving-beam light, 12V/24V, lens with clear-glass look, with position light, silver lens-retaining rim
1F8 009 797-101	1	chrome-plated rim
1F8 009 797-031	1	Ref. 37.5 H1 driving-beam light, 12V/24V, blue lens with clear-glass look, with position light, silver lens-retaining rim
1F8 009 797-111	1	chrome-plated rim
1F8 009 797-421	1	Ref. 25 H1 driving light, 12V/24V, lens with clear-glass look, with position light in LED-technology, silver lens-retaining rim
1F8 009 797-431	1	chrome-plated rim
1F8 009 797-121	1	Ref. 17.5 H1 driving-beam light, 12V/24V, silver lens-retaining rim lens with clear-glass look, with position light
1F8 009 797-131	1	blue lens with clear-glass look, with position light
Spare parts/Accessories:		
1F8 162 870-031	1	Light unit for -321/-341
1F8 162 871-021	1	for -331/-351
1F8 162 870-011	1	for -021/-101
1F8 162 871-011	1	for -031/-111
1F8 165 947-011	1	for -121
1F8 165 946-011	1	for -131
1F8 180 789-001	1	for -421/-431
9AG 168 666-001	1	Lens-retaining rim silver coloured
9AG 168 666-011	1	chrome-plated
8GH 002 089-133	1	H1 bulb, 12V55W
8GH 002 089-251	1	24V70W
8GP 003 594-121	10	W5W bulb, 12V5W
8GP 003 594-251	10	24V5W

For upright mounting

Rallye 3003 Compact

Black body, silver lens-retaining rim.

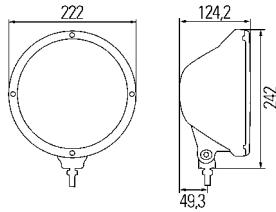

Part no.	Pk.	
1F3 010 119-011	1	Ref. 37.5 H1 driving-beam light, 12V/24V, lens with clear-glass look
1F3 010 119-021	1	blue lens with clear-glass look
1F3 010 119-001	1	Ref. 17.5 H1 driving-beam light, 12V/24V, lens with clear-glass look
Spare parts/Accessories:		
Light unit		
1F3 161 825-011	1	for -011
1F3 161 825-081	1	for -021
1F3 161 825-031	1	for -001
H1 bulb,		
8GH 002 089-133	1	12V55W
8GH 002 089-251	1	24V70W

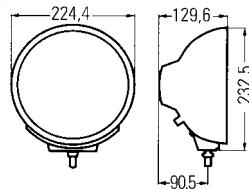

Luminator-Metal

Black die-cast cinc body and lens-retaining rim.



Part no.	Pk.	
1N8 007 560-031	1	H3 fog light, 12V/24V
1F8 007 560-401	1	Ref. 50 H1 driving light, 12V/24V, with clear-glass look and position light
1F8 007 560-041	1	Ref. 37.5 H1 driving-beam light, 12V/24V, with position light
1F8 007 560-301	1	lens with clear-glass look, with position light
1F8 007 560-011	1	Ref. 17.5 H1 driving-beam light, 12V/24V, lens with clear-glass look, with position light
Spare parts/Accessories:		
Light unit		
1N8 148 103-011	1	for -031
1F8 162 870-031	1	for -401
1F8 148 131-011	1	for -041
1F8 162 870-011	1	for -301
1F8 148 009-011	1	for -011
9AG 147 939-011	1	Lens-retaining rim
8HG 116 741-801	1	Bracket for two-point fixing (2 pcs.)
H3 bulb,		
8GH 002 090-133	1	12V55W
8GH 002 090-251	1	24V70W
H1 bulb,		
8GH 002 089-133	1	12V55W
8GH 002 089-251	1	24V70W
W5W bulb,		
8GP 003 594-121	10	12V5W
8GP 003 594-251	10	24V5W

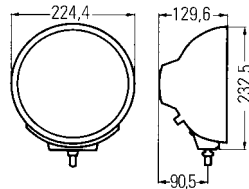

For upright mounting

Luminator-Metal CELIS®

Black die-cast cinc body and lens-retaining rim.

Part no.	Pk.	
1F8 007 560-201	1	H1 driving-beam light, 12V24V, lens with clear-glass look and position light in CELIS® technology incl. LEDs
Spare parts/Accessories:		
1F8 161 326-011	1	Light unit
9AG 147 939-011	1	Lens-retaining rim
8KB 161 334-007	5	Lead set with LED control electronics
8GH 002 089-133	1	H1 bulb, 12V55W
8GH 002 089-251	1	24V70W

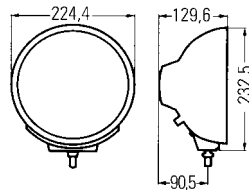

Luminator Chromium CELIS®

Chrome-plated die-cast cinc body and lens-retaining rim.

Part no.	Pk.	
1F8 007 560-211	1	H1 driving-beam light, 12V24V, lens with clear-glass look and position light in CELIS® technology incl. LEDs
Spare parts/Accessories:		
1F8 161 326-011	1	Light unit
8KB 161 334-007	5	Lead set with LED control electronics
8GH 002 089-133	1	H1 bulb, 12V55W
8GH 002 089-251	1	24V70W

For upright mounting

Luminator-Chromium

Chrome-plated die-cast cinc body and lens-retaining rim.

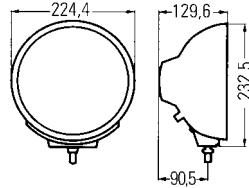

Part no.	Pk.	
1N8 007 560-021	1	H3 fog light, 12V/24V
1F8 007 560-411	1	Ref. 50 H1 driving light, 12V/24V, with position light and lens with clear-glass look
1F8 007 560-421	1	with position light and blue lens with clear-glass look
1F8 007 560-051	1	Ref. 37.5 H1 driving-beam light, 12V/24V, with position light and patterned cover lens
1F8 007 560-311	1	with position light and lens with clear-glass look
1F8 007 560-131	1	with position light and blue, patterned cover lens
1F8 007 560-321	1	with position light and blue lens with clear-glass look
1F8 007 560-451	1	Ref. 25 H1 driving light, 12V/24V, with position light in LED-technology and lens with clear-glass look
1F8 007 560-341	1	Ref. 17.5 H1 driving-beam light, 12V/24V, with position light and lens with clear-glass look
1F8 007 560-331	1	Ref. 17.5 H1 driving-beam light, 12V/24V, with position light and blue lens with clear-glass look
Spare parts/Accessories:		
1N8 148 103-011	1	Light unit for -021
1F8 162 870-031	1	for -411
1F8 162 871-021	1	for -421
1F8 148 131-011	1	for -051
1F8 162 870-011	1	for -311
1F8 158 926-011	1	for -131
1F8 162 871-011	1	for -321
1F8 180 789-001	1	for -451
1F8 165 946-011	1	for -331
1F8 165 947-011	1	for -341
9AG 147 939-021	1	Lens-retaining rim
8HG 116 741-801	1	Bracket for two-point fixing (2 pcs.)
8GH 002 090-133	1	H3 bulb, 12V55W
8GH 002 090-251	1	24V70W H1 bulb,
8GH 002 089-133	1	12V55W
8GH 002 089-251	1	24V70W W5W bulb,
8GP 003 594-121	10	12V5W
8GP 003 594-251	10	24V5W

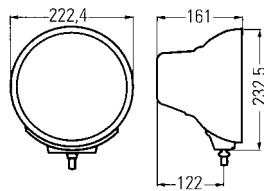

For upright mounting

Luminator Xenon

Red/black body, red lens-retaining rim and bracket made of die-cast cinc.

Part no.	Pk.	
1F8 007 560-561	1	Xenon driving light, with gas discharge bulb and 12V ballast unit
1F8 007 560-571	1	and 24V ballast unit
Spare parts/Accessories:		
1F8 149 644-011	1	Light unit
9AG 147 939-031	1	Lens-retaining rim
5DV 007 760-631	1	Ballast unit, 12V
5DV 007 810-171	1	24V
8HG 116 741-801	1	Bracket for two-point fixing (2 pcs.)
8GS 007 949-101	1	D2S gas discharge bulb, 35W

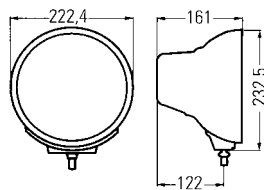

Luminator Xenon

Black body, red lens-retaining rim and bracket made of die-cast cinc. Lens with clear-glass look.

Part no.	Pk.	
1F8 007 560-621	1	Xenon driving light with gas discharge bulb and 12V ballast unit
1F8 007 560-631	1	and 24V ballast unit
Spare parts/Accessories:		
1F8 165 949-011	1	Light unit
9AG 147 939-031	1	Lens-retaining rim
5DV 008 855-001	1	Ballast unit, 12V
5DV 008 856-001	1	24V
8HG 116 741-801	1	Bracket for two-point fixing (2 pcs.)
8GS 009 028-021	1	D1S gas discharge bulb, 35W

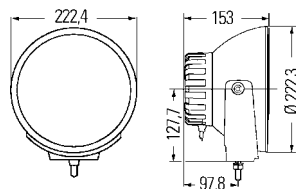

Luminator Xenon

Black body and bracket made of die-cast cinc. Chrome-plated rim. Lens with clear-glass look

Part no.	Pk.	
1F8 007 560-721	1	Xenon main-beam headlight with gas discharge bulb and 12V ballast unit integrated into body
1F8 007 560-731	1	with gas discharge bulb and 24V ballast unit integrated into body
Spare parts/Accessories:		
1F8 173 055-021	1	Light unit
9AG 147 939-061	1	Lens-retaining rim
8GS 007 949-101	1	D2S gas discharge bulb, 35W

For upright mounting

Luminator LED

Black die-cast aluminium body and bracket, chrome-plated lens-retaining rim.

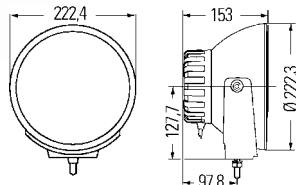

Part no.	Pk.	
1F8 011 002-001	1	LED-driving light, 12V/24V, with clear-glass look and LED-position light incl. LEDs

For flush mounting

FF® 40

With 12V bulb.

Mounting with supporting frame in the vehicle front. Lens with clear-glass look.

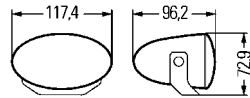

Part no.	Pk.	
1NA 010 047-101	1	H8 fog light
1FA 010 047-001	1	H11 driving-beam light
Spare parts:		
8GH 008 356-121	1	H8 bulb, 12V35W
8GH 008 358-121	1	H11 bulb, 12V55W

For horizontal surface mounting

FF® 40

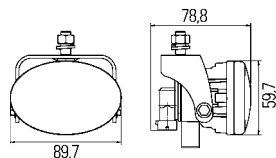

Part no.	Pk.	
1NA 010 047-811	1	H8 fog light set, 12V, with brackets, bulbs, relay with lead and accessories
1NA 010 047-111	1	H8 fog light, 12V, with bracket and 12V bulb
1FA 010 047-801	1	H11 driving light set with brackets, 12V bulbs, relay with lead and accessories
1FA 010 047-011	1	H11 driving light with bracket and 12V bulb
Spare parts:		
8GH 008 356-121	1	H8 bulb, 12V35W
8GH 008 358-121	1	H11 bulb, 12V55W

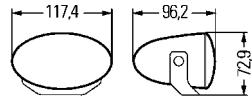

For upright or pendant mounting

FF® 50

Black plastic body. Lens with clear-glass look.

Part no.	Pk.	
1NA 008 283-801	1	H7 fog light set with 12V bulbs, relay, switch and lead set
1NA 008 283-001	1	H7 fog light with 12V bulb
1FA 008 283-811	1	H7 driving light set with 12V bulbs, relay, switch and lead set
1FA 008 283-011	1	H7 driving light with 12V bulb
1FA 008 283-861	1	H7 driving-beam light set, with blue lenses, 12V bulbs, relay, switch and lead set
1FA 008 283-031	1	H7 driving-beam light, with blue lens and 12V bulb
8GH 007 157-121	1	Spare parts/Accessories: H7 bulb, 12V55W

FF® 75

Black plastic body. Lens with clear-glass look.



Part no.	Pk.	
1NA 008 284-801	1	H7 fog light set with 12V bulbs, relay, switch and lead set
1NA 008 284-001	1	H7 fog light with 12V bulb
1FA 008 284-811	1	H7 driving light set with 12V bulbs, relay, switch and lead set
1FA 008 284-011	1	H7 driving light with 12V bulb
1FA 008 284-861	1	H7 driving-beam light set, with blue lenses, 12V bulbs, relay, switch and lead set
1FA 008 284-031	1	H7 driving-beam light, with blue lens and 12V bulb
8GH 007 157-121	1	Spare parts/Accessories: H7 bulb, 12V55W

For upright or pendant mounting

Comet FF® 100

Black plastic body. Lens with clear-glass look.

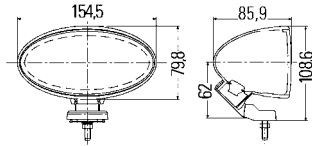

Part no.	Pk.	
1NA 007 891-821	1	H3 fog light set with 12V bulbs, relay with wiring harness, on/off switch and basalt grey body
1NA 007 891-041	1	H3 fog light with 12V bulb and basalt grey body
1FA 007 891-811	1	H3 driving light set with 12V bulbs, relay with lead set, on/off switch and ivory body,
1FA 007 891-841	1	and basalt grey body
1FA 007 891-061	1	H3 driving light with 12V bulb and basalt grey body
1FA 149 504-011	1	Spare parts: Light unit with 12V bulb for -811/-841/-061
4RA 965 400-001	1	Normally-open relay for -811/-821/-841
8GH 002 090-133	1	H3 bulb, 12V55W

For upright or pendant mounting

Comet FF® 300

Black plastic body. Lens with clear-glass look.

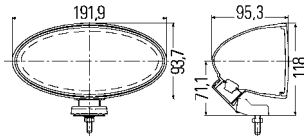

Part no.	Pk.	
1NB 007 892-821	1	H3 fog light set with 12V bulbs, relay with lead set, on/off switch and basalt grey body
1NB 007 892-041	1	H3 fog light with 12V bulb and basalt grey body
1NB 007 892-001	1	and ivory body
1FB 007 892-811	1	H3 driving light set with 12V bulbs, relay with lead set, on/off switch and ivory body,
1FB 007 892-841	1	and basalt grey body
1FB 007 892-011	1	H3 driving light with 12V bulb and ivory body
1FB 007 892-071	1	without bulb, with basalt grey body
1FB 007 892-131	1	without bulb, with blue lens with clear-glass look and basalt grey body
Spare parts/Accessories:		
1FB 149 519-011	1	Light unit with 12V bulb for -811/-841/-011/-071
1FB 162 881-011	1	without bulb for -131
4RA 965 400-001	1	Normally-open relay for -811/-821/-841
8GH 002 090-133	1	H3 bulb, 12V55W

For upright mounting

Micro-FF®

Black plastic body. Lens with clear-glass look.

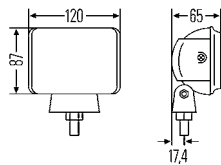

Part no.	Pk.	
1NA 007 133-001	1	H3 fog light, 12V
1FA 007 133-021	1	H3 driving light, 12V
8GH 002 090-133	1	Accessories: H3 bulb, 12V55W

For upright or pendant mounting

Comet 450

Black plastic body.

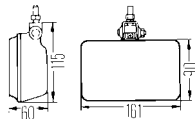

Part no.	Pk.	
1NB 005 860-801	1	H3 fog light set with 12V bulbs, relay with lead and switch
1NB 005 860-131	1	H3 fog light, 12V, without bulb
1NB 005 860-021	1	with bulb, yellow light
1FB 005 860-831	1	H3 driving light set with 12V bulbs and relay with lead
1FB 005 860-031	1	H3 driving light with 12V bulb
1FB 005 860-061	1	with bulb, yellow light
Spare parts/Accessories:		
1NB 137 001-021	2	Light unit, white for -801/131
1FB 137 006-021	2	for -831/-031
8GH 002 090-133	1	H3 bulb, 12V55W

For pendant surface mounting

181 Chrome

Chrome-plated plastic body.

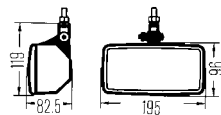

Part no.	Pk.	
1ND 003 590-401	1	H3 fog light, 12V/24V
1FD 003 590-411	1	H3 driving light, 12V/24V
Spare parts/Accessories:		
1FD 135 198-011	1	Light unit for -411
8GH 002 090-133	1	H3 bulb, 12V55W
8GH 002 090-251	1	24V70W

For upright or pendant mounting

Comet 550

Black plastic body.

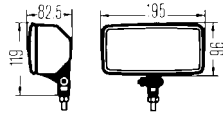

Part no.	Pk.	
1ND 005 700-841	1	H3 fog light set with 12V bulbs, relay with lead and switch
1ND 005 700-001	1	H3 fog light with 12V bulb
1ND 005 700-061	1	with hardened lens, without bulb, 12V/24V
1ND 005 700-021	1	with bulb, yellow light
1FD 005 700-851	1	H3 driving light set with 12V bulbs, relay with lead and switch
1FD 005 700-051	1	H3 driving light without bulb, 12V
1FD 005 700-301	1	with 12V bulb
Spare parts/Accessories:		
1ND 136 933-011	1	Light unit for -061
1FD 135 198-011	1	for -851/-051
6EG 001 567-041	10	On/off switch for -841
8GH 002 090-133	1	H3 bulb, 12V55W
8GH 002 090-251	1	24V70W

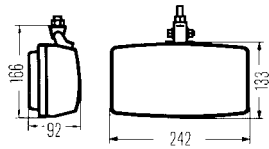

Jumbo 210 Chrome

Chrome plated body and lens-retaining rim.

Part no.	Pk.	
1NE 002 537-201	1	H3 fog light, 12V/24V
1FE 002 537-191	1	H3 driving light, 12V/24V
Spare parts/Accessories:		
9DF 112 246-001	1	Reflector with lens and retaining spring for -201
9DF 112 247-001	1	for -191
8GH 002 090-133	1	H3 bulb, 12V55W
8GH 002 090-251	1	24V70W

For upright or pendant mounting

Jumbo 220

Black plastic body.

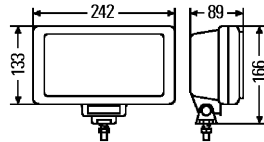

Part no.	Pk.	
1NE 006 300-051	1	H3 fog light, 12V/24V with black lens-retaining rim
1NE 006 300-011	1	with chrome-plated lens-retaining rim
1NE 006 300-101	1	with black lens-retaining rim, yellow light
<hr/>		
Ref. 37.5		
1FE 006 300-041	1	H3 driving-beam light, 12V/24V, with black lens-retaining rim
1FE 006 300-001	1	with chrome-plated lens-retaining rim
1FE 006 300-261	1	with chrome-plated lens-retaining rim and blue lens
<hr/>		
Ref. 17.5		
1FE 006 300-081	1	H3 driving-beam light, 12V/24V, with black lens-retaining rim
<hr/>		
Spare parts/Accessories:		
Light unit		
1NE 138 555-011	1	for -051/-011
1FE 138 520-011	1	for -041/-001
1FE 158 877-011	1	for -261
9AG 138 131-001	5	Lens-retaining rim, chrome-plated
8GH 002 090-133	1	H3 bulb, 12V55W
8GH 002 090-251	1	24V70W

Jumbo 320 FF®

Black plastic body. Lens with clear-glass look.

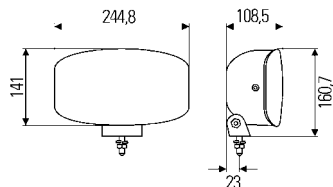

Part no.	Pk.	
1NE 008 773-031	1	H7 fog light, 12V/24V
<hr/>		
Ref. 37.5		
1FE 008 773-001	1	H7 driving-beam light, 12V/24V, without position light
1FE 008 773-041	1	with position light in bulb technology
1FE 008 773-081	1	with position light in LED technology, incl. LEDs
<hr/>		
1FE 008 773-061	1	with blue lens with clear-glass look, without position light
<hr/>		
Ref. 17.5		
1FE 008 773-011	1	H7 driving-beam light, 12V/24V, without position light
<hr/>		
Spare parts/Accessories:		
Light unit		
1FE 161 641-011	1	for -001
1FE 161 641-021	1	for -061
1FE 161 642-011	1	for -011
1FE 161 644-011	1	for -041
8GH 007 157-121	1	H7 bulb, 12V55W
8GH 007 157-241	1	24V70W
8GP 003 594-121	10	W5W bulb, 12V5W
8GP 003 594-251	10	24V5W

For upright or pendant mounting

Jumbo 320 Xenon

Black plastic body. Lens with clear-glass look.

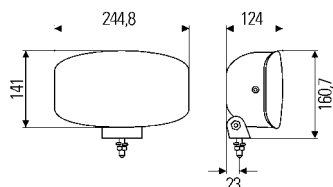

Part no.	Pk.	
1FE 008 773-021	1	Xenon driving-beam light with gas discharge bulb and position light in LED technology incl. LEDs, with 12V ballast unit
1FE 008 773-051	1	with 24V ballast unit
Spare parts/Accessories:		
1FE 161 576-011	1	Light unit
		Ballast unit,
5DV 008 855-001	1	12V
5DV 008 856-001	1	24V
8GS 007 949-101	1	D2S gas discharge bulb, 35W



Universal radio remote control unit

The Hella remote control is ECE type tested and carries the RF suppression symbol.

The alternating code feature excludes interference with other remote controls. The convenient way to switch work lights by remote control.

Maximum switching capacity: 2 x 100W.

With green control diode for on-off switching control.

Part no.	Pk.	
6ZN 160 705-001	1	Universal radio remote control unit, 12V
6ZN 160 705-011	1	24V
6ZN 160 707-001	1	Spare parts: Radio remote control, 12V



Two-point fixing

Fixing system made of stainless steel which can be shortened, bent or twisted as required.

Length: 80 - 240 mm. Contents: 2 pieces.

Part no.	Pk.	
8HG 116 741-801	1	Two-point fixing



Universal lead set

For 1 to 2 auxiliary lights.

Including relay with 16A fuse, lead and installation material.

Part no.	Pk.	
8KA 002 309-811	1	Universal lead set



Normally-open relay

With bracket and blade-type fuse.

With three 6.3 mm blade terminal contacts.

Max. load (at +80 °C): 15A at 12V and 24V.

Part no.	Pk.	
4RA 003 530-001	1	Normally-open relay, 4-pin, 12V
4RA 003 530-051	1	24V



On-off switch

Rocker switch with green warning light and 12V bulb.

With three 6.3 mm blade terminal contacts.

Max. load: 10A at 12V.

Part no.	Pk.	
6EH 007 946-001	1	On-off switch

Built-in headlights

Micro DE®

Light aperture: 40 mm dia.

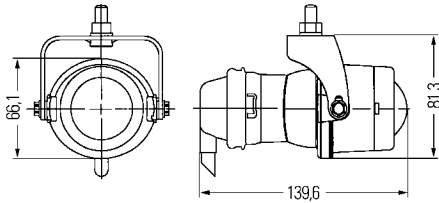

Part no.	Pk.	
1NL 008 090-821	1	DE®-H3-fog light set with 12V bulbs, black body, cap, alu-ring, designpanels, holder and relays with lead
1NL 008 090-031	1	DE®-H3 fog light with black ring, cap, holder and screws, with 12V bulb
1NL 008 090-037	60	
1NL 008 090-117	1	with 24V bulb
		Spare parts/Accessories:
9GH 147 009-007	30	Rubber sealing cap
9HD 149 253-007	1	Plastic sealing cap with plug
8JD 156 150-807	1	Socket set (20 pcs.)
6EH 007 946-001	1	On/off switch
		H3 bulb,
8GH 002 090-133	1	12V55W
8GH 002 090-251	1	24V70W

DE®-Xenon

Light aperture: 40 mm dia.

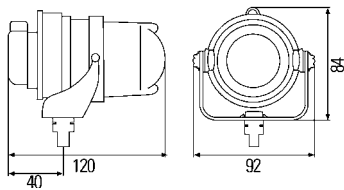

Part no.	Pk.	
1F0 008 390-801	1	DE®-Xenon driving light set with black decorative rings, gas discharge bulbs, 12V ballast units, relay with lead
1F0 008 390-001	1	DE®-Xenon driving light with black decorative ring, gas discharge bulb, 12V ballast unit and relay with lead
		Spare parts/Accessories:
1F0 160 197-001	1	Light unit
5DV 007 760-631	1	Ballast unit, 12V
8JD 156 151-807	1	Socket set (20 pcs.)
6EH 007 946-001	1	On/off switch
8GS 007 949-101	1	D2S gas discharge bulb, 35W
8HG 153 152-001	1	Convenience mount with adjustment screw

Built-in headlights

With H3 light and bulb.
Light aperture: 54 mm dia.

Mounting depth: 105 mm.

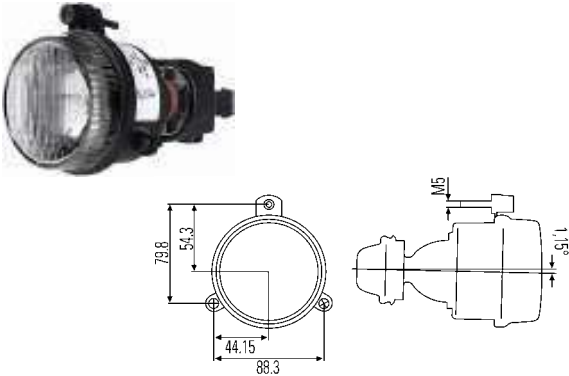
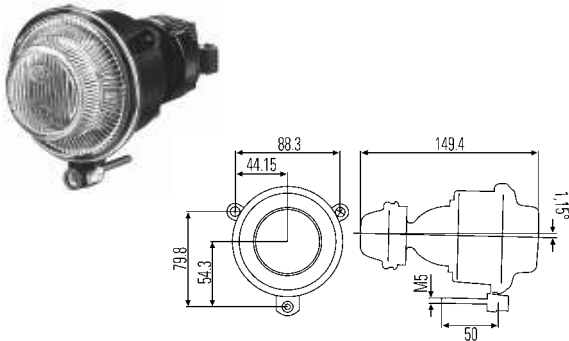

Part no.	Pk.	
1NL 007 186-061	1	DE®-H3 fog light, 12V, with plastic sealing cap
1NL 007 186-067	30	
1NL 007 186-027	1	DE®-H3 fog light, 12V, without plastic sealing cap
1NL 007 186-047	1	DE®-H3 fog light, 24V, plastic sealing cap with cover and lead
Spare parts/Accessories:		
9HD 149 253-007	1	Plastic sealing cap with cover, lead and plug
9GH 147 009-007	30	Rubber sealing cap
8JD 156 150-807	1	Socket set (20 pcs.)
8GH 002 090-133	1	H3 bulb, 12V55W
8GH 002 090-251	1	H3 bulb, 24V70W

Premium 50

With H3 light. Light aperture: Ø 50 mm dia.

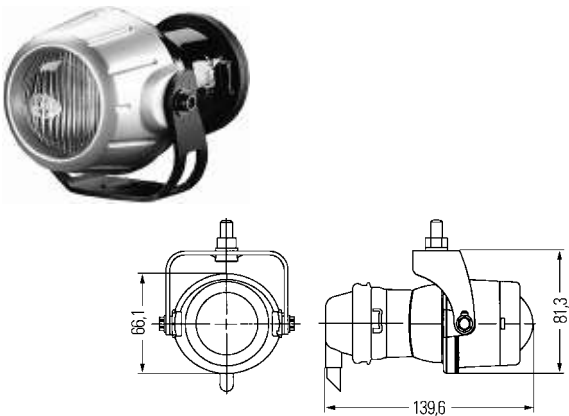

Part no.	Pk.	
1NL 008 090-301	1	DE®-H3 fog light with 12V bulb, black metal body, alu-designpanel and bracket
Spare parts/Accessories:		
9GH 147 009-007	30	Rubber sealing cap
9HD 149 253-007	1	Plastic sealing cap with plug
8JD 156 150-807	1	Socket set (20 pcs.)
8GH 002 090-133	1	H3 bulb, 12V55W
8GH 002 090-251	1	H3 bulb, 24V70W

Premium 50 mm

With H3 light. Light aperture: Ø 50 mm dia.

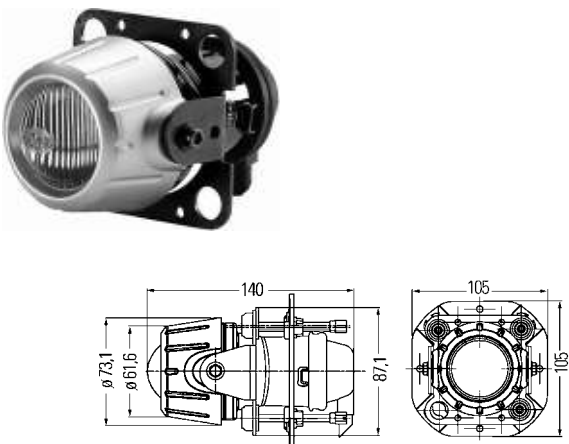

Part no.	Pk.	
1NL 008 090-317	24	DE®-H3 fog light with 12V bulb
1NL 008 090-327	24	with 3 attachment elements and 24V bulb
Spare parts/Accessories:		
9AH 161 786-017	12	Supporting frame
9GH 147 009-007	30	Rubber sealing cap
9HD 149 253-007	1	Plastic sealing cap with plug
8JD 156 150-807	1	Socket set (20 pcs.)
8GH 002 090-133	1	H3 bulb, 12V55W
8GH 002 090-251	1	H3 bulb, 24V70W

Built-in headlights

DE®-Xenon Premium

Black body with alu-ring, designpanel.

Light aperture: 50 mm dia.

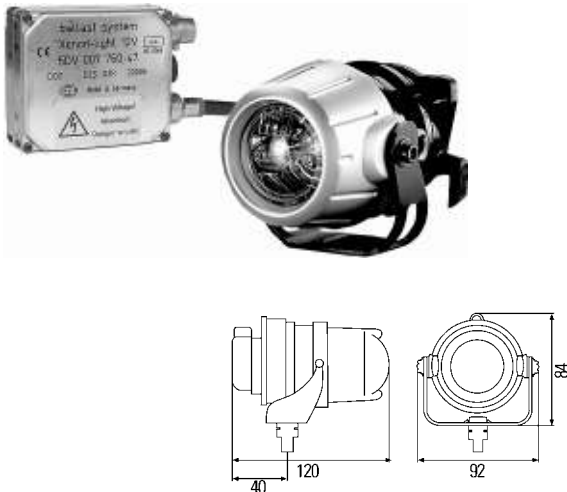

Part no.	Pk.	
1F0 008 390-821	1	DE®-Xenon driving-beam light set with gas discharge bulbs and 12V ballast units
1F0 008 390-301	1	DE®-Xenon driving-beam light with gas discharge bulb and 12V ballast unit
Spare parts:		
1F0 160 197-001	1	Light unit
5DV 007 760-631	1	Ballast unit, 12V
8GS 007 949-101	1	D2S gas discharge bulb, 35W

Premium 50 mm

With gas discharge bulb. Light aperture: 50 mm dia.

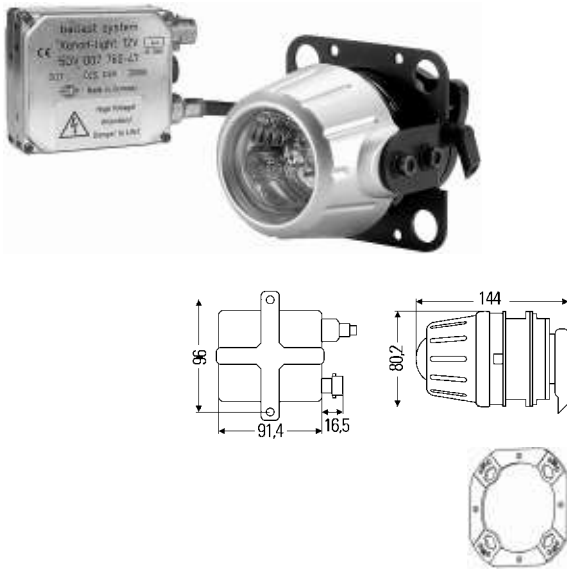

Part no.	Pk.	
1F0 008 390-317	12	DE®-Xenon driving light with 12V ballast unit
1F0 008 390-327	12	with 3 attachment elements and 24V ballast unit
Spare parts/Accessories:		
5DV 007 760-631	1	Ballast unit, 12V
5DV 007 810-171	1	24V
8GS 007 949-101	1	D2S gas discharge bulb, 35W
9AH 161 786-017	12	Supporting frame

Premium 60 mm

With H9 light. Light aperture: 56 mm dia.



Part no.	Pk.	
1KL 009 486-001	1	DE®-H9 driving-beam light with 3 attachment elements and 12V bulb
Spare parts:		
8GH 008 357-001	1	H9 bulb, 12V65W

Built-in headlights

Module 60

With HB3 light. Lens with reflector bonded.
With 12V bulb(s). Light aperture: 60 mm dia.

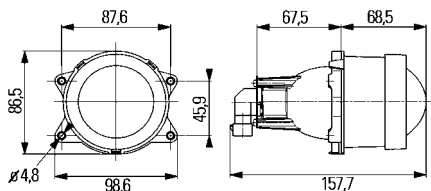
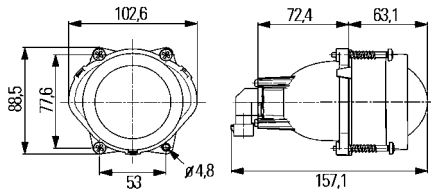

Part no.	Pk.	
1ML 998 570-011	1	DE®-HB3 dipped-beam headlight without position light
1KL 998 570-021	1	DE®-HB3 driving light without position light
1KL 998 570-031	1	with position light
Spare parts/Accessories:		
8GH 005 635-121	1	HB3 bulb, 12V/65W
8GP 003 594-141	1	W3W bulb, 12V/3W
8JA 990 295-217	10	Plug for HB3 bulb

With H7 light. Light aperture: 90 mm dia.

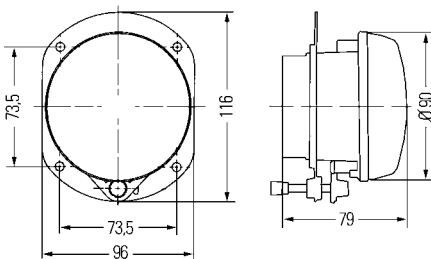

Part no.	Pk.	
1N0 008 582-001	1	H7 fog light with 12V bulb
1N0 008 582-007	24	
1N0 008 582-011	1	with 24V bulb
1N0 008 582-017	24	
1N0 008 582-042	1	with 24V-HDLL bulb
Spare parts/Accessories:		
9GH 158 051-007	1	Cap
9XS 124 218-037	500	Clamp
8GH 007 157-121	1	H7 bulb, 12V/55W
8GH 007 157-241	1	24V/70W
8GH 007 157-231	1	24V/70W (HDLL)

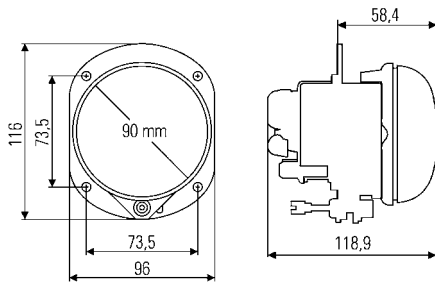

Built-in headlights

With H15 light and daytime running light.

Light aperture: 90 mm dia.

For mounting in the front apron or in combination with 90 mm dia. headlights.

Part no.	Pk.	
1N0 010 294-001	1	H15 fog light with daytime running light and 12V bulb
1N0 010 294-011	1	and 24V bulb
1F0 010 293-001	24	H15 driving light with daytime running light and 12V bulb
Accessories:		
8GJ 168 119-001	1	H15 bulb, 12V15/55W
8JD 162 581-802	1	Plug connector set, 3 pole

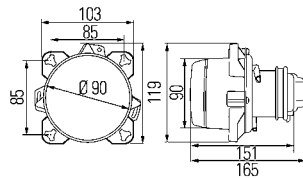

90 mm Classic

DE®-H7 dipped-beam headlight.

Light aperture: 90 mm dia.

Reflector with lens bonded.

Part no.	Pk.	
1LL 008 193-117	36	DE®-H7 dipped-beam headlight with 12V bulb
1LL 008 193-127	36	with 24V bulb
Spare parts/Accessories:		
9XB 152 977-001	36	Setting element, headlight levelling (3 pcs.)
9GH 152 654-012	36	Rubber cap, for 90° plug
9GH 145 943-012	1	Rubber cap without ventilation, for use with a 2-pole receptacle body
9AH 157 659-007	20	Supporting frame
8GH 007 157-121	1	H7 bulb, 12V55W
8GH 007 157-241	1	24V70W
8GH 007 157-231	1	24V70W (HDLL)

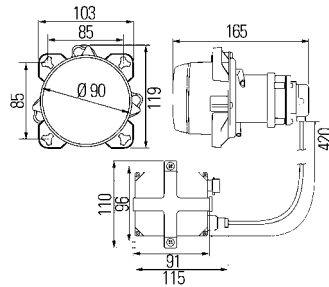

Built-in headlights

90 mm Classic

Xenon dipped-beam headlight with gas discharge bulb.
Light aperture: 90 mm dia.
Reflector with lens bonded.

Part no.	Pk.	
1LL 008 194-017	8	Xenon dipped-beam headlight with 12V ballast unit
1LL 008 194-051	1	with 24V ballast unit
Spare parts/Accessories:		
1LL 158 060-031	1	Light unit without gas discharge bulb and ballast unit
5DV 007 760-631	1	Ballast unit, 12V
5DV 007 810-171	1	Ballast unit, 24V
8HG 151 866-001	5	Mounting bracket for ballast unit, without rubber gasket
9XD 990 308-001	5	Mounting bracket for ballast unit, with rubber gasket
9XB 152 977-001	1	Setting element, headlight levelling (3 pcs.)
8JD 156 151-807	1	Socket set (20 pcs.)
9AH 157 659-007	1	Supporting frame
8GS 007 949-101	1	D2S gas discharge bulb, 35W
		D1S gas discharge bulb

90 mm Classic

Light aperture: 90 mm dia.
Reflector with lens bonded.

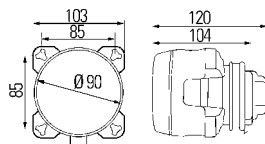

Part no.	Pk.	
1K0 008 191-001	1	FF@-H7 driving-beam light with position light and 12V bulbs
1K0 008 191-007	36	
1K0 008 191-227	36	and 12V bulbs, without adjustable screws
1K0 008 191-021	1	and 24V bulbs
1K0 008 191-027	36	
1K0 008 191-212	1	and 24V HD bulb
FF@-H7 driving-beam light without position light, with 12V bulb		
1K0 008 191-011	1	
1K0 008 191-017	36	
1K0 008 191-041	1	with 24V bulb
1K0 008 191-047	36	
Spare parts/Accessories:		
9XB 152 977-001	1	Setting element, headlight levelling (3 pcs.)
9GH 152 654-007	1	Sealing cap, ventiled, flat
9GH 145 943-001	1	Sealing cap, ventiled, deep
8JD 156 150-807	1	Socket set (20 pcs.)
9AH 157 659-007	1	Supporting frame
9NS 152 922-007	500	Adjusting screw with lock points
9XS 124 218-027	500	Clamp
8GH 007 157-121	1	H7 bulb, 12V55W
8GH 007 157-241	1	H7 bulb, 24V70W
8GH 007 157-231	1	H7 bulb, 24V70W (HDLL)
8GP 002 067-121	10	T4W bulb, 12V4W
8GP 002 067-241	10	T4W bulb, 24V4W

Built-in headlights

90 mm Classic

Light aperture: 90 mm dia.
Reflector with lens bonded.

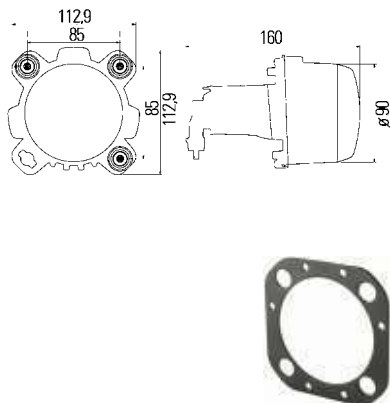
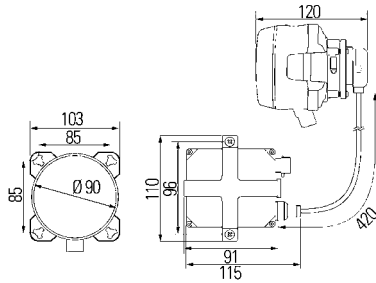

Part no.	Pk.	
1K0 008 192-001	1	Xenon driving-beam light with position light, gas discharge bulb and 12V ballast unit
1K0 008 192-007	8	
1K0 008 192-027	1	and 24V ballast unit
1K0 008 192-011	1	Xenon driving-beam light without position light, with gas discharge bulb and 12V ballast unit
1K0 008 192-017	8	
1K0 008 192-091	1	with gas discharge bulb and 24V ballast unit
Spare parts/Accessories:		
		Light unit
1K0 158 059-061	1	(for -001/-007/-027)
1K0 158 059-071	1	(for -011/-017/-091)
		Ballast unit,
5DV 007 760-631	1	12V
5DV 007 810-171	1	24V
		Holder for ballast unit
8HG 151 866-001	5	without rubber gasket
9XD 990 308-001	5	with rubber gasket
		Socket set (20 pcs.)
8JD 156 150-807	1	for T4W bulb
8JD 156 151-807	1	for ballast unit
9AH 157 659-007	1	Supporting frame
9NS 152 922-007	500	Adjusting screw with lock points
9XS 124 218-027	500	Clamp
8GS 007 949-101	1	D2S gas discharge bulb, 35W
		T4W bulb,
8GP 002 067-121	1	12V4W
8GP 002 067-241	1	24V4W

90 mm Performance

Light aperture: 90 mm dia. Plug connector HB4.
Reflector made of die-cast aluminium with hardened lens bonded.
3 attachment elements are enclosed.

Part no.	Pk.	
1ML 247 042-027	36	DE®-H1 dipped-beam headlight with 12V bulb
1ML 247 042-227	36	with 12V bulb, can be changed over to ES tourist solution
1ML 247 042-037	36	with 24V-HDLL bulb
Spare parts/Accessories:		
		Headlight levelling,
6NM 007 282-221	1	12V
6NM 008 299-501	1	24V
8JD 156 151-807	1	Plug set (HB4)
9AH 254 228-012	2	Supporting frame
9AH 254 228-017	36	
9XD 254 226-007	500	Joint
9XD 254 227-007	500	Clamp
		H1 bulb,
8GH 002 089-133	1	12V55W
8GH 002 089-251	1	24V70W
8GH 002 089-491	1	24V70W HDLL

Built-in headlights

90 mm Performance

Light aperture: 90 mm dia. Plug connector HB4.

Reflector made of die-cast aluminium with hardened lens bonded.
3 attachment elements are enclosed.

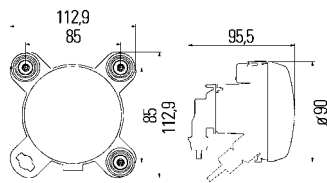

Part no.	Pk.	
1K0 247 043-001	1	FF®-H1 driving light with position light and 12V bulbs
1K0 247 043-007	36	
1K0 247 043-021	1	and 24V-HDLL bulb
1K0 247 043-027	36	
1K0 247 043-097	36	and 24V-HDLL bulb, can be changed over to LES tourist solution
1K0 247 043-011	1	FF®-H1 driving light without position light, with 12V bulb
1K0 247 043-017	36	
1K0 247 043-031	1	with 24V-HDLL bulb
1K0 247 043-037	36	
1K0 247 043-107	36	with 24V-HDLL bulb, can be changed over to LES tourist solution
Spare parts/Accessories:		
9AH 254 228-012	2	Supporting frame
9AH 254 228-017	36	
9XD 254 226-007	500	Joint
9XD 254 227-007	500	Clamp
8JD 156 151-807	1	Plug set (20 pcs.) for H1 bulb
8JD 156 150-807	1	for T4W bulb
8GH 002 089-133	1	H1 bulb, 12V55W
8GH 002 089-251	1	24V70W
8GH 002 089-491	1	24V70W HDLL T4W bulb,
8GP 002 067-121	10	12V4W
8GP 002 067-241	10	24V4W

Built-in headlights

90 mm Performance

Can be changed over to LES tourist solution.
Light aperture: 90 mm dia. HB4 connector.
 Reflector made of die-cast aluminium with hardened lens bonded.
 3 attachment elements are enclosed.

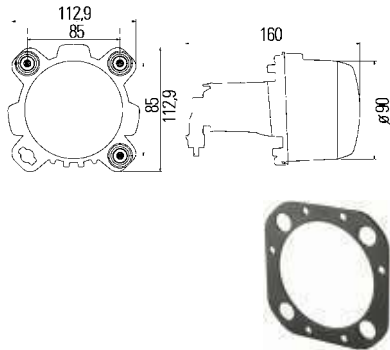

Part no.	Pk.	
1ML 247 042-187	36	DE®-H1 dipped-beam headlight with 12V bulb
1ML 247 042-207	36	with 24V bulb
1ML 247 042-167	36	with 24V HD bulb
Spare parts/Accessories:		
		Headlight levelling,
6NM 007 282-221	1	12V
6NM 008 299-501	1	24V
8JD 156 151-807	1	Plug set (HB4)
9AH 254 228-012	2	Supporting frame
9AH 254 228-017	36	
9XD 254 226-007	500	Joint
9XD 254 227-007	500	Clamp
8GH 002 089-133	1	12V55W
8GH 002 089-251	1	24V70W
8GH 002 089-361	1	24V70W HDLL

90 mm Performance

Light aperture: 90 mm dia. With bulb(s). Plug connector HB4.
 Reflector made of die-cast aluminium with hardened lens bonded.
 3 attachment elements are enclosed.

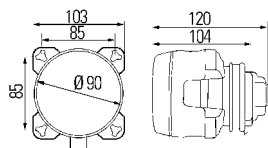

Part no.	Pk.	
1K0 247 043-117	36	FF®-H1 driving light with Premium fixing, with position light, 12V
1K0 247 043-127	36	without position light, 12V
1K0 247 043-137	36	with position light, 24V-HDLL
1K0 247 043-147	36	without position light, 24V-HDLL
FF®-H1 driving light with Classic fixing, with position light, 12V		
1K0 247 043-157	36	with position light, 12V
1K0 247 043-167	36	without position light, 12V
Spare parts/Accessories:		
		Supporting frame
9AH 169 580-011	1	for -117/-127/-137/-147
9AH 157 659-007	20	for -157/-167
9XD 254 226-007	500	Joint
9XD 254 227-007	500	Clamp
		Plug set (20 pcs.)
8JD 156 151-807	1	for H1 bulb
8JD 156 150-807	1	for T4W bulb
8GH 002 089-133	1	H1 bulb,
8GH 002 089-251	1	12V55W
8GH 002 089-251	1	24V70W
8GH 002 089-491	1	24V70W HDLL
8GP 002 067-121	10	T4W bulb,
8GP 002 067-241	10	12V4W
		24V4W

Built-in headlights

90 mm Bi-Xenon®

Bi-Xenon® dipped-beam headlight and main light with gas discharge bulb.
Light aperture: 90 mm dia.
Reflector with lens bonded.

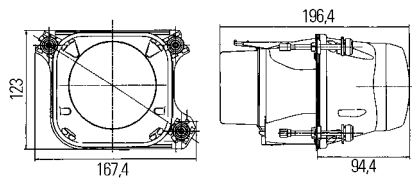

Part no.	Pk.	
1LL 008 934-011	1	Bi-Xenon® headlight with 12V ballast unit
1LL 008 934-031	1	with 24V ballast unit
Spare parts/Accessories:		
8JD 162 211-801	1	Socket set for main beam (20 pcs.)
8JA 990 295-127	10	DEUTSCH plug, 2-pole Lead, 3700 mm, with DEUTSCH plug, relay and fuse,
8KB 990 299-221	1	12V
8KB 990 299-231	1	24V
8XX 010 315-001	1	Automatic ultrasonic headlight levelling with 4 m long lead, 12V
8XX 010 315-101	1	with 10 m long lead, 12V
8XX 010 315-011	1	with 4 m long lead, 24V
8GS 007 949-101	1	D2S gas discharge bulb, 35W

90 mm Premium Bi-Xenon®

Bi-Xenon® dipped-beam headlight and driving-beam light with gas discharge bulb, can be changed over to ES tourist solution.
Light aperture: 90 mm dia.
Reflector made of die-cast aluminium with hardened lens bonded.
3 attachment elements are enclosed.

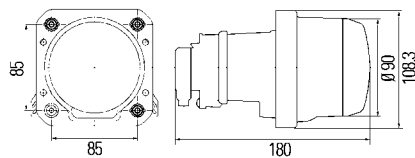

Part no.	Pk.	
1LL 009 997-011	1	Bi-Xenon® headlight with 12V ballast unit
1LL 009 997-051	1	with 24V ballast unit
Spare parts/Accessories:		
Ballast unit,		
5DV 007 760-631	1	12V
5DV 007 810-171	1	24V
9AH 169 580-011	20	Supporting frame
6NM 007 282-231	1	Headlight levelling incl. bracket, 12V
8JD 156 151-807	1	Socket set (20 pcs.)
8JA 746 184-022	10	Supersealed plug, 2-pole Automatic ultrasonic headlight levelling
8XX 010 315-001	1	with 4 m long lead, 12V
8XX 010 315-101	1	with 10 m long lead, 12V
8XX 010 315-011	1	with 4 m long lead, 24V
8GS 007 949-101	1	D2S gas discharge bulb, 35W

Built-in headlights

90 mm Premium

Bi-Halogen dipped-beam headlight and driving-beam, can be changed over to ES tourist solution.
Light aperture: 90 mm dia.

Reflector made of die-cast aluminium with hardened lens bonded.

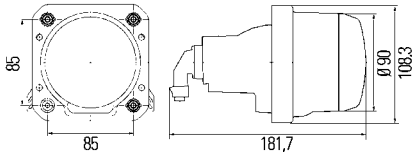

Part no.	Pk.	
1LL 009 998-011	1	Bi-Halogen dipped-beam headlight with 12V bulb
1LL 009 998-051	1	with 24V bulb
Spare parts/Accessories:		
9AH 169 580-011	1	Supporting frame
6NM 007 282-221	1	Headlight levelling incl. bracket, 12V
8JD 156 151-807	1	Plug set (20 pcs.)
8JA 746 184-022	10	Supersealed plug, 2-pole
8KW 744 837-002	50	Superseal jack contact
9GD 746 185-002	50	Superseal single conductor seal
8GH 007 157-121	1	H7 bulb, 12V55W
8GH 007 157-241	1	24V70W

90 mm Premium

DE®-H7 dipped-beam headlight, can be changed over to ES tourist solution.
Light aperture: 90 mm dia.

Reflector made of die-cast aluminium with hardened lens bonded.
3 attachment elements are enclosed.

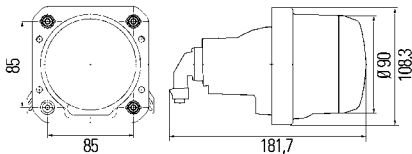

Part no.	Pk.	
1ML 009 999-011	1	DE®-H7 dipped-beam headlight with 12V bulb
1ML 009 999-051	1	with 24V bulb
Spare parts/Accessories:		
9AH 169 580-011	1	Supporting frame
6NM 007 282-221	1	Headlight levelling incl. bracket, 12V
8JD 156 151-807	1	Plug set (20 pcs.)
8JA 746 184-022	10	Supersealed plug, 2-pole
8KW 744 837-002	50	Superseal jack contact
9GD 746 185-002	50	Superseal single conductor seal
8GH 007 157-121	1	H7 bulb, 12V55W
8GH 007 157-241	1	24V70W

90 mm LED Module

LED dipped-beam headlight.
With 3 white power LEDs, 30W and lead.
Light aperture: 90 mm dia.

Reflector and lens with clear-glass look made of plastic.

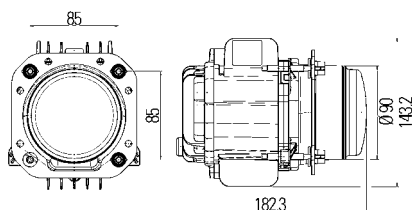

Part no.	Pk.	
1ML 010 820-011	1	LED dipped-beam headlight, 12V/24V
Accessories:		
9AH 169 580-011	1	Supporting frame
8JA 746 184-022	10	Supersealed plug, 2-pole
8KW 744 837-002	50	Superseal jack contact
9GD 746 185-002	50	Superseal single conductor seal

Built-in headlights

For buses and mobile homes with 24V operating voltage.
Light with arched lens.
Without position light. Light aperture: 100 mm dia.

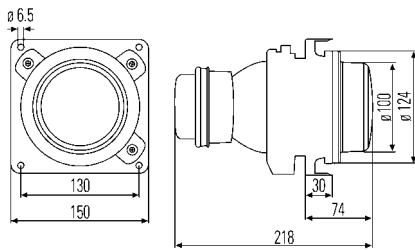

Part no.	Pk.	
1BL 007 834-037	1	Xenon dipped-beam headlight with gas discharge bulb and 24V ballast unit
1KL 007 834-097	1	Xenon driving-beam light with gas discharge bulb and 24V ballast unit
1BL 007 834-007	1	DE®-H1 dipped-beam headlight with supporting frame
1BL 007 834-132	1	with 2-pole AMP plug connector, without supporting frame
1KL 007 834-027	1	DE®-H1 main-beam headlight
1NL 007 834-017	1	DE®-H1 fog light
Spare parts/Accessories:		
5DV 007 810-171	1	Ballast unit, 24V
8JD 156 151-807	1	Socket set (20 pcs.) for -037/-097
9GH 145 943-001	1	Rubber sealing cap for -027
9HD 155 239-001	12	Plastic sealing cap with lead and plug for -007/-017
8GS 007 949-101	1	D2S gas discharge bulb, 35W
8GH 002 089-251	1	H1 bulb, 24V70W

For trucks, buses and vehicle tuners.
Headlight with flat lens.
Without position light. Light aperture: 100 mm dia.

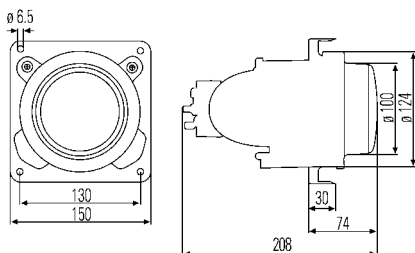

Part no.	Pk.	
1BL 007 834-047	1	DE®-H1 dipped-beam headlight suitable for headlight leveller
1KL 007 834-067	1	DE®-H1 main-beam headlight
1NL 007 834-057	1	DE®-H1 fog light
Spare parts/Accessories:		
6NM 004 375-541	3	Electr. headlight leveller, 12V for -047
8WS 008 549-001	1	Lens cleaning system with spray system, 12V
8WS 008 549-501	1	24V
9GH 145 943-001	1	Rubber sealing cap for -027/-067
9HD 155 239-001	12	Plastic sealing cap with lead and plug for -007/-017/-047/-057
8GH 002 089-133	1	H1 bulb, 12V55W
8GH 002 089-251	1	24V70W



Accessories

Ultrasonic headlight levelling for Ø 50 mm, Ø 90 mm and Ø 100 mm Xenon built-in headlights

Contents:

2 ultra-sonic sensors with mounting brackets, electronic control, 2 actuator motors, lead sets and installation instructions.

The ultra-sonic sensor can be mounted on the floor of the car with a bracket and connected to the central electronic control. This control transfers its adjustment values to the actuator motors on the headlights in accordance with the specific load.

If the vehicle height is reduced at the rear as well as the front axle when loaded, a second sensor is required.

The control module is laid out for two-sensor operation.

Part no.	Pk.	
8XX 010 315-001	1	Automatic ultrasonic headlight levelling with 4 m long lead, 12V
8XX 010 315-101	1	with 10 m long lead, 12V
8XX 010 315-011	1	with 4 m long lead, 24V

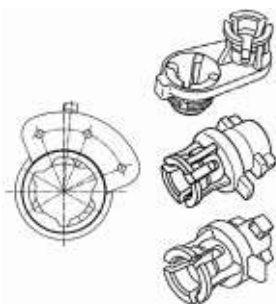

Headlight leveller accessory set

for 50 mm dia. built-in headlights 1BL 009 071-...
for 90 mm dia. built-in headlights 1BL 008 193-...,
1BL 008 194-..., 1BL 247 042-...
In combination with the headlamp adjusters
6NM 007 282-221/-227/-231, 6NM 008 299-501

Contents:

1 bracket suitable for left and right, 3 joint pieces.

Part no.	Pk.	
8HG 183 586-001	1	Headlight leveller accessory set

Headlight cleaning system

for 90 mm dia. and 100 mm dia. built-in headlights

For cleaning from 2 to 4 headlights.

Contents:

Pump, control module, lead set, nozzle and reinforced hose.



Part no.	Pk.	
8WS 008 549-001	1	Headlight cleaning system with fixed nozzles, 12V
8WS 008 549-501	1	24V
<hr/>		
8WT 008 549-101	1	Headlight cleaning system with single telescopic nozzles, 12V
8WT 008 549-601	1	24V
<hr/>		
8WT 008 549-201	1	Headlight cleaning system with double telescopic nozzles, 12V
8WT 008 549-701	1	24V
<hr/>		
		Spare parts:
9GS 146 999-727	5	Hose

Built-in headlights

H3 driving-beam light unit with position light.

Light aperture: 120 mm dia.

For vehicles with 4-headlight-system.

Only for spare parts requirement.

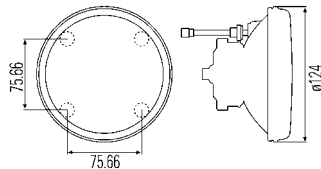

Design

Part no.	Pk.	
1K2 006 147-031	1	H3 driving-beam light, in connection with DE® dipped-beam headlight 1BL 006 349-007, with sealing cap and 12V bulb
1K2 006 147-051	1	in connection with DE® dipped-beam headlight 1BL 006 349-011, without sealing cap and bulb, 12V/24V
1K2 006 147-041	1	with black shield, in connection with DE® dipped-beam headlight 1BL 006 349-011, without sealing cap and bulb, 12V/24V
Spare parts/Accessories:		
8GH 002 090-133	1	H3 bulb, 12V55W
8GH 002 090-251	1	24V70W T4W bulb,
8GP 002 067-121	10	12V4W
8GP 002 067-241	10	24V4W

Light aperture: 132 mm dia.

Supporting frame made of plastic.

Reflector made of sheet metal, glued to glass lens.

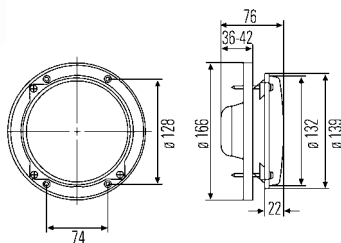

Part no.	Pk.	
1L3 996 002-411	1	H4 headlight with position light
Spare parts/Accessories:		
8GJ 002 525-131	1	H4 bulb, 12V60/55W
8GJ 002 525-251	1	24V75/70W T4W bulb,
8GP 002 067-121	10	12V4W
8GP 002 067-241	10	24V4W

H4 headlight with sealing cap.

Light aperture: 135 mm dia.

e. g. for American and Japanese cars.

In accordance with SAE dimensions J 571.

Only for spare parts requirement.



Part no.	Pk.	
1L3 002 850-068	1	H4 headlight with position light and T4W bulb
1L3 005 649-017	84	without position light, for four-point mounting, for Claas
Spare parts/Accessories:		
9GH 126 647-011	10	Sealing cap for -068
8GJ 002 525-131	1	H4 bulb, 12V60/55W
8GP 002 067-121	10	T4W bulb, 12V4W



Built-in headlights

H1 dipped-beam headlight without sealing cap.

Light aperture: 135 mm dia.

Can be used with 1K3 114 155-001.

In accordance with SAE 4002 and 4005.

Only for spare parts requirement.

Part no.	Pk.	
1M3 114 178-001	1	H1 dipped-beam headlight
		Accessories:
8GH 002 089-133	1	H1-bulb, 12V55W



H1 dipped-beam headlight without sealing cap (see accessories).

Light aperture: 135 mm dia.

Can be used with 1K3 114 155-001.

In accordance with SAE 4001.

Part no.	Pk.	
1K3 114 155-001	1	H1 driving light
		Accessories:
9HD 140 976-001	5	Cap
8GH 002 089-133	1	H1-bulb, 12V55W



Light aperture: 165 mm dia.

For vehicles with 7" light units, e.g. for American and Japanese cars.

In accordance with SAE 6006, SAE 6012, SAE 6013.

Only for spare parts requirement.

Part no.	Pk.	
1L6 002 395-261	1	H4 headlight with position light and sealing cap
		H4 headlight set: two headlights with position light
		Accessories:
8GJ 002 525-131	1	H4 bulb, 12V60/55W
8GP 002 067-121	10	T4W bulb, 12V4W

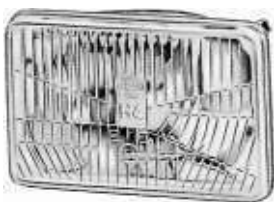

With H4 light.

Light aperture: 164 x 103 mm.

For American and Japanese cars with rectangular 4-headlamp system.

In accordance with SAE J 571.

Only for spare parts requirement.

Part no.	Pk.	
1LB 003 177-081	1	H4 headlight without position light, with sealing cap
1LB 003 177-511	1	with position light and sealing cap
		Accessories:
8GJ 002 525-131	1	H4 bulb, 12V60/55W
8GP 002 067-121	10	T4W bulb, 12V4W

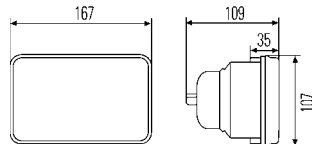

With H1 light.

Light aperture: 164 x 103 mm.

For inner units. Mounting depth: 124 mm.

Part no.	Pk.	
1KB 003 177-061	1	H1 main beam headlight with sealing cap
		Accessories:
1VB 005 444-037	20	Receiving part
8GH 002 089-133	1	H1-bulb, 12V55W

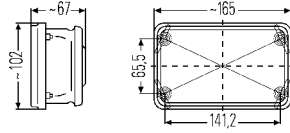

Built-in headlights

With H2 light and sealing cap.

Light aperture: 164 x 103 mm.

Can be used with 1AB 003 177-... and 1BL 005 380-...

Part no.	Pk.	
1NB 004 691-147	1	H2 fog light
8GH 002 857-121	1	Accessories: H2 bulb, 12V55W

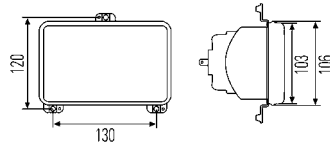

With H4 light and position light.

With three-point fixing, sealing cap and 12V bulb.

Light aperture: 164 x 103 mm.

Only for spare parts requirement.

Part no.	Pk.	
1LB 006 277-137	36	H4 headlight
8GJ 002 525-131	1	Spare parts: H4 bulb, 12V60/55W
8GJ 002 525-251	1	24V75/70W T4W bulb,
8GP 002 067-121	10	12V4W
8GP 002 067-241	10	24V4W

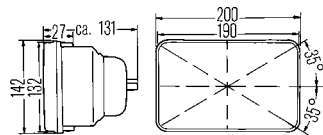

With H4 light, position light and sealing cap.
adjustment devices.

For American and Japanese cars
with 2-headlamp system.

Only for spare parts requirement.

Part no.	Pk.	
1LE 003 427-041	1	H4 headlight
9GH 126 647-011	10	Spare parts/Accessories: Cap
8GJ 002 525-131	1	H4 bulb, 12V60/55W
8GP 002 067-121	10	T4W bulb, 12V4W



SAE-Conversions

Headlamp receiving units for 5¾" headlamps with SAE-fixing points, without supporting frame.

Part no.	Pk.	
9AL 118 027-007	20	Adjusting frame I (inner)
9AL 118 028-007	20	Adjusting frame II (outer)
9AG 084 320-005	15	Lens-retaining rim
9NS 114 014-106	3000	Screw
9NS 119 463-005	500	Adjustment screw assembly
9XS 118 079-005	50	Fixed point

Headlamp receiving units for rectangular headlamps 164 x 103 mm without rotation lock, without supporting frame.

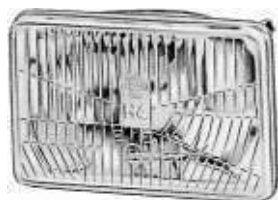

Part no.	Pk.	
9AL 120 514-001	8	Adjusting frame I
9AL 120 515-001	8	Adjusting frame II
9AG 120 516-005	17	Lens-retaining rim
9NS 114 014-106	3000	Screw
9NS 124 485-001	5	Adjustment screw assembly
9XS 118 079-005	50	Fixed point

Headlamp receiving units for rectangular headlamps 164 x 103 mm, without rotation lock, without supporting frame.

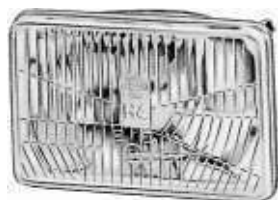

Part no.	Pk.	
1VB 005 444-037	20	Receiving part (assembled)

Headlamp receiving unit for rectangular headlamps 190 x 132 mm with SAE-fixing points, without supporting frame.



Part no.	Pk.	
9AL 132 293-027	8	Adjusting frame (assembled)

Built-in headlights

With H1 dipped-beam light, H1 driving-beam light, position light and 12V bulbs.

Light aperture: 248 x 117 mm.
Only for spare parts requirement.

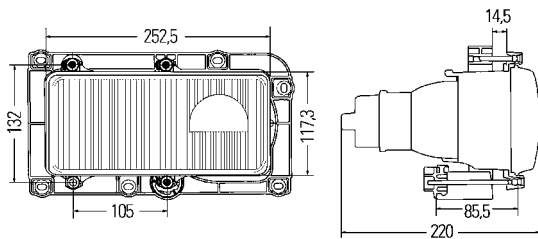
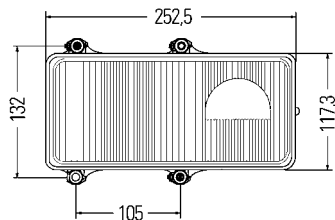

Part no.	Pk.	
1DL 005 600-097	1	DE®-H1 headlight, without lead, left
1DL 005 600-107	1	right
8GH 002 089-251	1	Spare parts: H1 bulb, 24V70W
8GP 002 067-241	1	T4W bulb, 24V4W
1DL 007 872-017	1	DE®-H1 headlight with electric headlight leveller and supporting frame, without lead, left
1DL 007 872-027	1	right
1DL 007 872-037	1	DE®-H1 headlight without electric headlight leveller, suitable for headlight leveller, without lead, left
1DL 007 872-047	1	right
1DL 007 872-077	1	DE®-H1 headlight without electric headlight leveller, suitable for headlight leveller, with lead, left
1DL 007 872-087	1	right
9AH 149 259-015	4	Spare parts: Supporting frame with adj. devices, left
9AH 149 260-015	4	right
6NM 007 231-037	36	Headlight leveller, 24V for -017/-027
8GH 002 089-251	1	H1 bulb, 24V70W
8GP 002 067-241	10	T4W bulb, 24V4W

Built-in headlights

With sealing cap. Light aperture: 138 x 124 mm.

Supporting frame made of black plastic.

Type of protection: IP5K4K. Only for spare parts requirement.

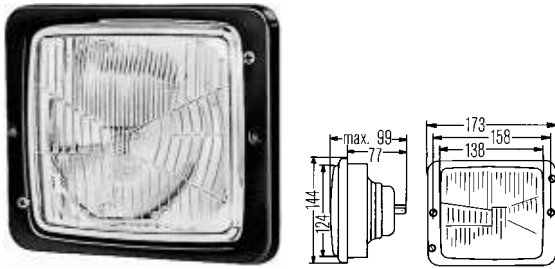

Part no.	Pk.	
1LA 004 109-217	36	H4 headlight with position light
1LA 004 109-227	36	with hardened glass lens and position light
9FF 111 606-021	10	Spare parts/Accessories: Bulb holder for position light
8GJ 002 525-131	1	H4 bulb,
8GJ 002 525-251	1	12V60/55W
8GP 002 067-121	10	24V75/70W
8GP 002 067-241	10	T4W bulb,
		12V4W
		24V4W

With H4 light and position light.

Light aperture: 270 x 170 mm.

Black plastic support frame. Mounting depth: 117 mm.

Only for spare parts requirement.

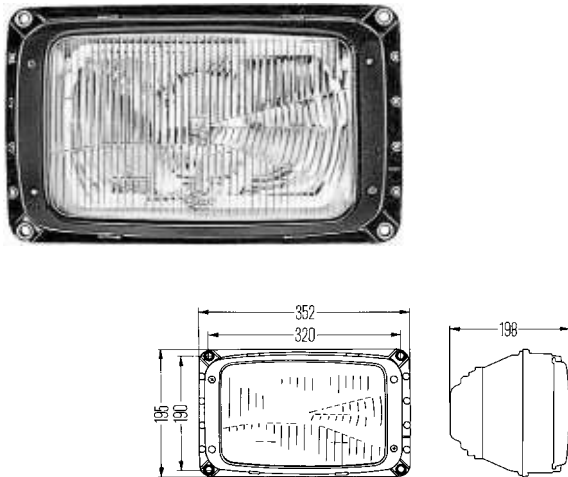

Part no.	Pk.	
1LG 003 434-187	4	H4 headlight
9ES 122 221-007	7	Spare parts/Accessories: Lens
9DE 131 520-017	2	Reflector
9GT 067 751-001	10	Grommet
8GJ 002 525-131	1	H4 bulb,
8GJ 002 525-251	1	12V60/55W
8GP 002 067-121	10	24V75/70W
8GP 002 067-241	10	T4W bulb,
		12V4W
		24V4W

For vehicles with max. speed of 25 km/h,

e.g. for agricultural machines.

Light aperture: 115 x 95 mm.

Black plastic body and lens-retaining rim.

Only for spare parts requirement. National type test for Germany.

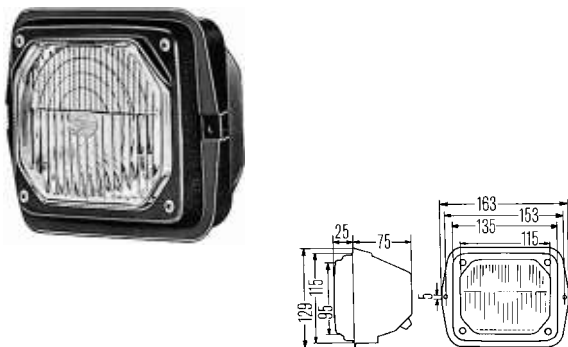

Part no.	Pk.	
1TA 003 570-001	1	Permanently dipped-beam headlight
1TA 122 718-001	1	Spare parts/Accessories: Light unit
8GP 002 067-121	10	T4W bulb, 12V4W

External-fitting headlights

Symmetrical light, without position light.

Light aperture: 105 mm dia.

Black body made of sheet metal, lens-retaining rim with protective grille.

M14 x 1.5 hollow fixing bolt.

Only for spare parts requirement.

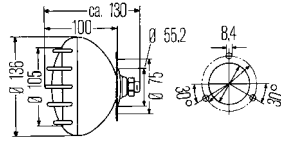

Part no.	Pk.	
1X0 001 515-021	1	Permanently dipped-beam headlight
Spare parts/Accessories:		
9GD 023 639-001	10	Gasket for lens
9KS 075 139-001	10	Lens-retaining spring
8GA 002 083-131	1	F2 bulb,
8GA 002 083-251	1	12V35W

Symmetrical light, with position light.

Light aperture: 105 mm dia.

Black body, with M12 fixing screw.

For Claas. National type test for Germany.

Only for spare parts requirement.

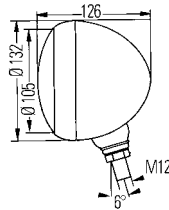

Part no.	Pk.	
1S0 001 430-011	1	S2 headlight
Spare parts/Accessories:		
9ES 012 060-011	1	Lens
9GD 023 639-001	10	Gasket
9DR 090 206-001	1	Reflector
9FF 090 500-001	2	Bulb holder for position light
9KS 075 139-001	10	Lens-retaining spring
8GD 002 084-131	1	S2 bulb, 35/35W
8GP 002 067-121	1	T4W bulb, 12V4W

Symmetrical light, with position light.

Light aperture: 130 mm dia.

Black body made of sheet metal, with M18 x 32 hollow fixing bolt.

National type test for Germany.

Only for spare parts requirement.

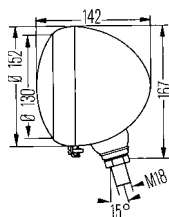

Part no.	Pk.	
1S3 001 117-041	1	S2 headlight
Spare parts/Accessories:		
9ES 015 675-001	1	Lens
9GD 024 183-001	10	Gasket for lens
9DR 060 567-001	1	Reflector
9FF 090 500-001	2	Bulb holder for position light
9KS 075 307-001	10	Lens-retaining spring
8GD 002 084-131	1	S2 bulb, 35/35W
8GP 002 067-121	10	T4W bulb, 12V4W

With H4 light and position light. Light aperture: 135 mm dia.

Rubber body and suitable light units are to be ordered separately.

Only for spare parts requirement.

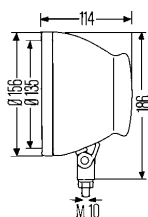

Part no.	Pk.	
1L3 002 850-068	1	H4 headlight
Spare parts/Accessories:		
9BG 127 179-001	1	Rubber body with universal bracket with fixing screw M10
8GJ 002 525-131	1	H4 bulb,
8GP 002 067-121	10	12V60/55W
		T4W bulb,
		12V4W

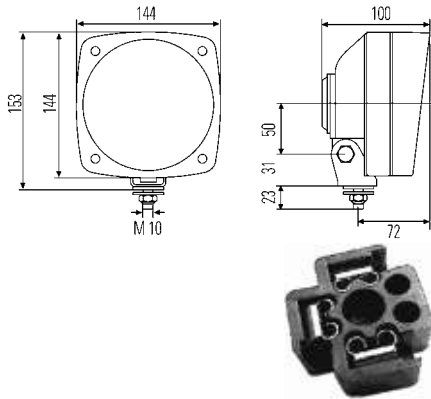

External-fitting headlights

Light aperture: 140 mm dia.
 Black plastic body.
 Universal bracket with M10 fixing screw.
 Only for spare parts requirement.

Part no.	Pk.	
1L3 996 026-041	1	H4 headlight with position light
		Accessories:
9HD 990 101-001	2	Cap
8GJ 002 525-131	1	H4 bulb,
8GJ 002 525-251	1	12V60/55W
		24V75/70W
8GP 002 067-121	10	T4W bulb,
8GP 002 067-241	10	12V4W
		24V4W
8JA 990 065-001	10	Plug for R2- and H4 bulb

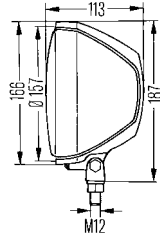

With symmetrical light and position light.

Light aperture: 157 mm dia.
 Black plastic body.
 National type test for Germany.
 Only for spare parts requirement.

Part no.	Pk.	
1S5 003 178-431	1	S2 headlight with universal bracket with M12 fixing screw
		Accessories:
8GD 002 084-131	1	S2 bulb,
8GD 002 084-251	1	12V35/35W
		24V45/40W
8GP 002 067-121	10	T4W bulb,
8GP 002 067-241	10	12V4W
		24V4W

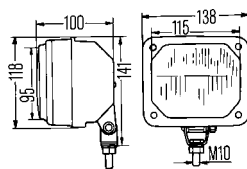

For vehicles with max. speed of 25 km/h; e. g. for agricultural machines. With symmetrical light and position light. Light aperture: 115 x 95 mm.

Black plastic body and lens-retaining rim.
 Universal bracket with M10 fixing screw.
 Only for spare parts requirement. National type test for Germany.

Part no.	Pk.	
1TA 003 570-101	1	Headlight with permanently dipped beam, 12V15W
		Spare parts/Accessories:
1TA 122 718-021	1	Light unit
8GP 002 067-121	10	T4W bulb, 12V4W

Work lights for upright or pendant mounting

5760

Lens pattern for far-reaching illumination. With grommet.

Light aperture: 120 mm dia.

Recommended angle of inclination: 15° - 20°.

Reflector made of sheet metal, glued to glass lens.

Black plastic body with extending edge to protect lens.

Pivot base with M10 fixing screw.

Without vibration damping. Type of protection: IP5K4K.

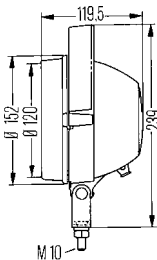
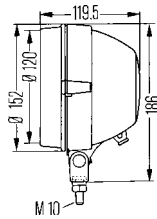
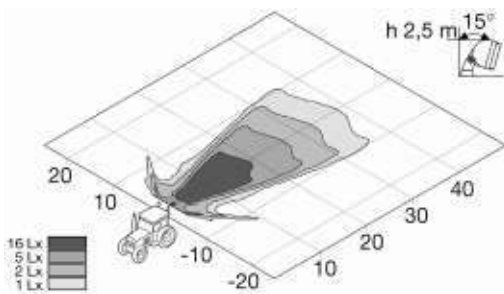

Part no.	Pk.	
		H3 work light
1G3 005 760-221	1	without handle, protective grill and switch
1G3 005 760-227	27	
		H3 work light
1G3 005 760-021	1	with handle, protective grill, switch and longer bracket holder
		Spare parts/Accessories:
1G3 135 211-011	1	Light unit
6EB 005 633-001	10	Switch
8GH 002 090-271	1	H3 bulb, 12V35W
8GH 002 090-133	1	12V55W
8GH 002 090-251	1	24V70W

Work lights for upright or pendant mounting

5760

Lens pattern for far-reaching illumination. With grommet.

Light aperture: 120 mm dia.

Recommended angle of inclination: 15° - 20°.

Lens with steel reflector bonded.

Black plastic body with extending edge to protect lens.

Pivot base with M10 fixing screw.

Without vibration damping.

Type of protection: IP5K4K.

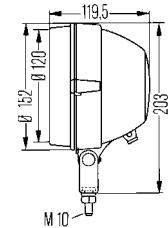
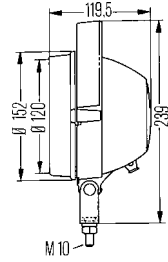
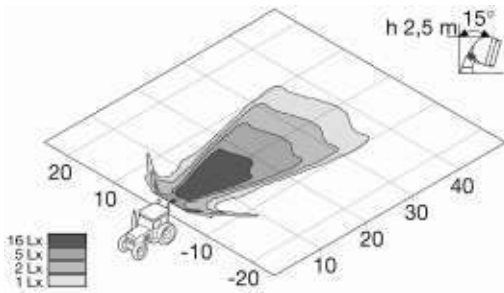

Part no.	Pk.	
1G3 005 760-001	1	H3 work light with handle and switch
1G3 005 760-011	1	with handle, without switch
1G3 005 760-031	1	with handle, without switch
1G3 005 760-201	1	without handle and switch
1G3 005 760-207	27	
1G3 005 760-211	1	without handle, with switch and longer bracket holder
Spare parts/Accessories:		
1G3 135 211-011	1	Light unit
6EB 005 633-001	10	Switch
		H3 bulb,
8GH 002 090-271	1	12V35W
8GH 002 090-133	1	12V55W
8GH 002 090-251	1	24V70W

Work lights for upright or pendant mounting

5760

Lens pattern for close-range illumination. Light aperture: 120 mm dia.

Recommended angle of inclination: 15° - 20°.

Lens with steel reflector bonded.

Black plastic body with extending edge to protect lens.

Pivot base with M10 fixing screw.

Without vibration damping. Type of protection: IP5K4K.

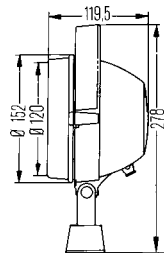
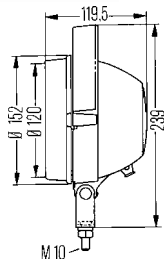
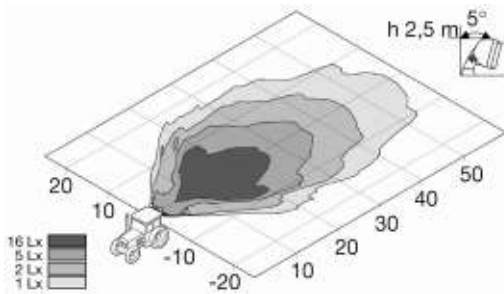

Part no.	Pk.	
1G3 005 760-041	1	H3 work light with handle and switch
1G3 005 760-057	1	with handle, switch and U-bracket for four-point mounting
Spare parts/Accessories:		
1G3 141 019-011	1	Light unit
6EB 005 633-001	10	Switch
9XD 130 261-001	5	Bracket for -057
8GH 002 090-271	1	H3 bulb, 12V35W
8GH 002 090-133	1	12V55W
8GH 002 090-251	1	24V70W

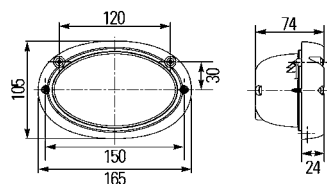
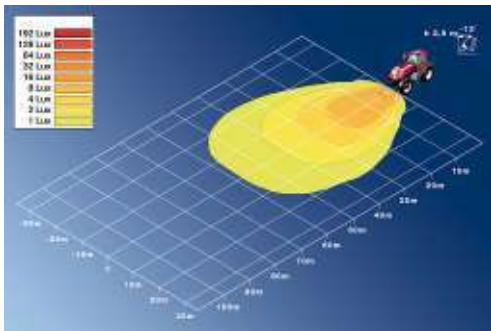
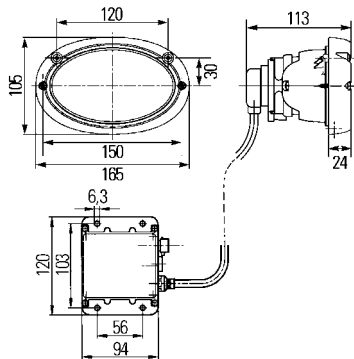
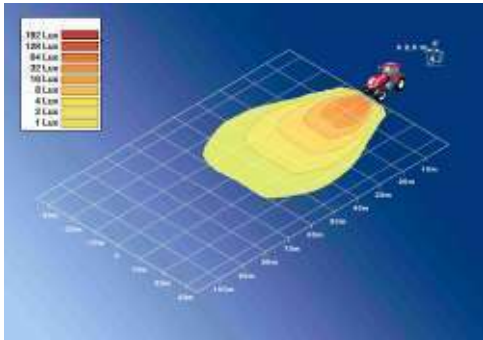

Built-in work lights

Oval 100 Xenon

Lens pattern for close-range illumination. With gas discharge bulb.
Light aperture: 130 x 75 mm.

Recommended angle of inclination: 10° - 15°.
 Reflector made of die-cast aluminium, glued to hardened glass lens.
 Black plastic body with extending edge to protect lens.
 Two 4.0 x 40 mm fixing screws.
 Mounting area: 142 x 92 mm. Type of protection: IP5K4K.

Part no.	Pk.	
1GA 996 361-581	1	Xenon work light with single reflector and 24V ballast unit
5DV 007 810-171	1	Ballast unit, 24V
8GS 007 949-101	1	D2S gas discharge bulb, 35W
8JD 156 151-807	1	Socket set for ballast unit (20 pcs.)
Spare parts/Accessories:		

Oval 100 with FF® reflector

Lens pattern for wide close-range illumination..
Light aperture: 130 x 75 mm.

Recommended angle of inclination: 10° - 15°.
 Reflector made of die-cast aluminium, glued to hardened glass lens.
 Black plastic body with extending edge to protect lens.
 Two 4.0 x 40 mm fixing screws.
 Mounting area: 142 x 92 mm. Type of protection: IP5K4K.

Part no.	Pk.	
1GA 996 161-111	1	FF®-H3 work light with double reflector, AMP plug connector and 12V55W bulbs
1GA 996 161-351	1	with single reflector, AMP plug connector and 12V55W bulb
9GH 993 984-001	20	Cap for AMP plug connector
8GH 002 090-271	1	H3 bulb,
8GH 002 090-133	1	12V35W
8GH 002 090-251	1	12V55W
8JD 008 151-011	1	24V70W
8JD 008 151-011	10	Socket for AMP plug connector
8KW 701 235-033	100	Blade receptacles, 6.3 mm
8KB 990 299-001	1	2000 mm long connecting lead for AMP plug connector with cap

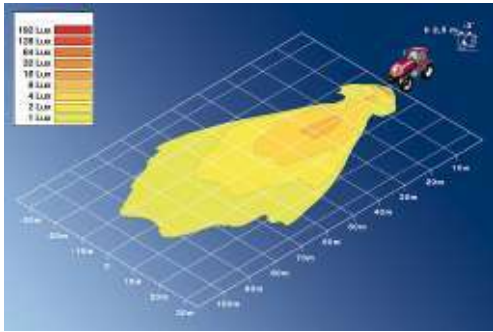

Built-in work lights

Oval 100 with FF® reflector

Lens pattern for long-range illumination.

Light aperture: 130 x 75 mm.

Recommended angle of inclination: 5° - 10°.

Reflector made of diecast aluminium, glued to hardened glass lens.

Black plastic body with extending edge to protect lens.

Two 4,2 x 45 mm fixing screws.

Mounting area: 142 x 92 mm. Type of protection: IP5K4K.

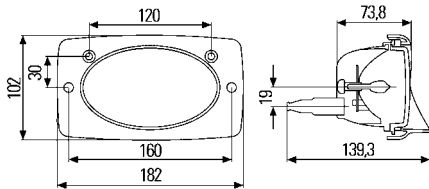
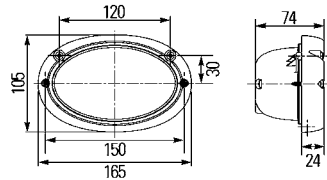

Part no.	Pk.	
1GA 996 161-101	1	FF® H3 work light with oval lens-retaining rim, lens without optical pattern and single reflector, with AMP plug connector, protection cap and 12V55W bulb
1GA 996 361-431	1	with grommet, without bulb
1GA 996 161-671	1	FF® H3 work light fits into mounting holes of headlights 1AB/1GD 006 213-... Inclination 6°. With angular lens-retaining rim, lens without optical pattern, single reflector, AMP plug connector with protection cap and 12V55W bulb
9GH 993 984-001	20	Spare parts/Accessories: Cap for AMP plug connector
8GH 002 090-271	1	H3 bulb, 12V35W
8GH 002 090-133	1	12V55W
8GH 002 090-251	1	24V70W
8JD 008 151-011	10	Socket for AMP plug connector
8KW 701 235-033	100	Blade receptacles, 6.3 mm
8KB 990 299-001	1	2000 mm long connecting lead for AMP plug connector with cap

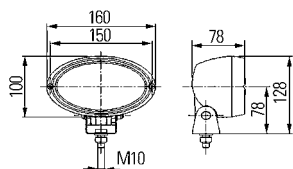
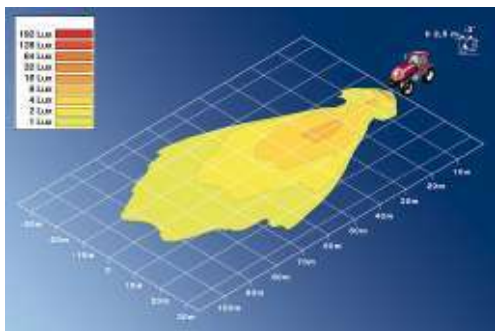

External fitting work lights for upright mounting

Oval 100 with FF® reflector

Lens pattern for long-range illumination.

Light aperture: 130 x 75 mm.

Recommended angle of inclination: 10° - 15°.

Reflector made of die-cast aluminium glued to hardened glass lens.

Black plastic body with extending edge to protect lens.

Pivot base with M10 fixing screw.

Type of protection: IP5K4K.

Part no.	Pk.	
1GA 996 161-281	1	FF® H3 work light lens without optical pattern, single reflector, AMP plug connector with protection cap and 12V55W bulb
Spare parts/Accessories:		
9GH 993 984-001	20	Cap for AMP plug connector
		H3 bulb,
8GH 002 090-271	1	12V35W
8GH 002 090-133	1	12V55W
8GH 002 090-251	1	24V70W
8JD 008 151-011	10	Socket for AMP plug connector
8KW 701 235-033	100	Blade receptacles, 6.3 mm
8KB 990 299-001	1	2000 mm long connecting lead for AMP plug connector with cap
8HG 990 263-111	1	Mounting bracket for tubular mount on 15 mm - 28 mm dia. pipes

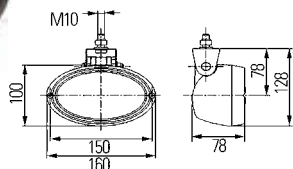
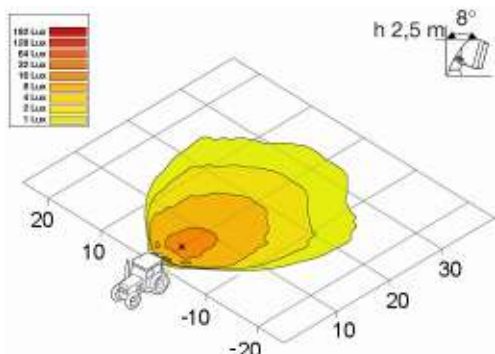

Work light for pendant surface mounting

Oval 100 with FF® reflector

Lens pattern for close-range illumination.

Light aperture: 130 x 75 mm.

Recommended angle of inclination: 10° - 15°.

Reflector made of die-cast aluminium glued to hardened glass lens.

Black plastic body with extending edge to protect lens.

Pivot base with M10 fixing screw.

Type of protection: IP5K4K.

Part no.	Pk.	
1GA 996 461-747	30	FF® H3 work light lens without optical pattern, single reflector, AMP plug connector with protection cap and 12V55W bulb
Spare parts/Accessories:		
9GH 993 984-001	20	Cap for AMP plug connector
		H3 bulb,
8GH 002 090-271	1	12V35W
8GH 002 090-133	1	12V55W
8GH 002 090-251	1	24V70W
8JD 008 151-011	10	Socket for AMP plug connector
8KW 701 235-033	100	Blade receptacles, 6.3 mm
8KB 990 299-001	1	2000 mm long connecting lead for AMP plug connector with cap
8HG 990 263-111	1	Mounting bracket for tubular mount on 15 mm - 28 mm dia. pipes

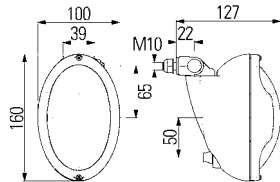

For vertical surface-mounting to forklifts.

Oval 100 FL

Lens pattern for wide close-range and object illumination.

Light aperture: 130 x 75 mm.

Recommended angle of inclination: 0°.

Reflector made of die-cast aluminium glued to hardened lens.

Black plastic body and lens-retaining rim.

Pivot base with M10 fixing screw.

With 430 mm long connection lead.

Type of protection: IP6K9K and IPX9K.

Part no.	Pk.	
1GN 996 361-461	1	H3 work light with non-patterned glass lens, grommet and 12V55W bulbs
1GN 996 361-651	1	and 24V70W bulbs
		Spare parts/Accessories:
8GH 002 090-271	1	H3 bulb, 12V35W
8GH 002 090-133	1	12V55W
8GH 002 090-251	1	24V70W

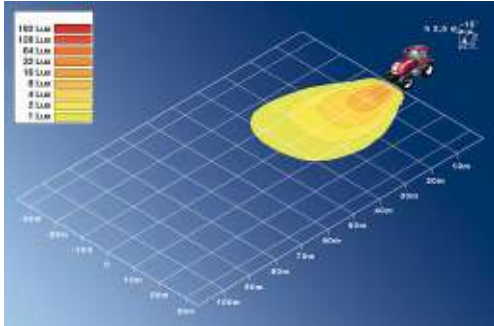

Work lights for upright or pendant mounting

Oval 100 with FF® reflector

Lens pattern for wide close-range illumination..

Light aperture: 130 x 75 mm.

Recommended angle of inclination: 10° - 15°.

Reflector made of die-cast aluminium, glued to hardened glass lens.

Black plastic body with extending edge to protect lens.

Pivot base with M10 fixing screw.

Pivot range vertical 105°.

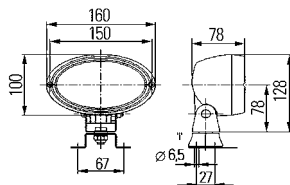
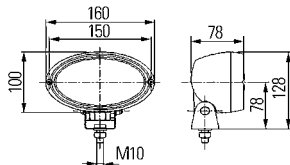

Part no.	Pk.	Description
1GA 996 361-421	1	FF® H3 work light Type of protection: IP5K4K, with single reflector and grommet, without bulb
1GA 996 361-501	1	with lens without optical pattern, single reflector and grommet, without bulb
1GA 996 161-121	1	FF® H3 work light Type of protection: IP5K4K and IPX9K, with single reflector, AMP plug connector, protection cap and 12V55W bulb
1GA 996 361-171	1	FF® H3 work light Type of protection: IP5K4K bzw. IPX9K, with single reflector, AMP plug connector, vibration damping and 24V70W bulb
1GA 996 461-547	18	FF® H3 work light Type of protection: IP5K4K bzw. IPX9K, with single reflector, 600 mm lead with DEUTSCH plug connector, vibration damping and 24V70W bulb
1GA 996 161-581	1	FF® H3 work light with single reflector, AMP plug connector, vibration damping, mounting bracket for four-point mounting and 24V70W bulb
9GH 993 984-001	20	Spare parts/Accessories: Cap for AMP plug connector
8GH 002 090-271	1	H3 bulb, 12V35W
8GH 002 090-133	1	12V55W
8GH 002 090-251	1	24V70W
8JD 008 151-011	10	Socket for AMP plug connector
8KW 701 235-033	100	Blade receptacles, 6.3 mm 2000 mm long connecting lead
8KB 990 299-001	1	for AMP plug connector with cap
8HG 990 263-111	1	Mounting bracket for tubular mount on 15 mm - 28 mm dia. pipes

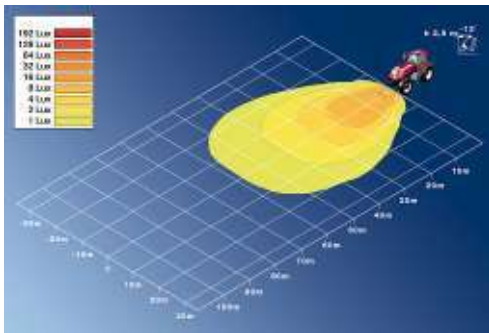

Work lights for upright or pendant mounting

Oval 100 with FF® reflector

**Lens pattern for wide ground illumination.
Light aperture: 130 x 75 mm.**

Recommended angle of inclination: 10° - 15°.
Reflector made of die-cast aluminium, glued to hardened glass lens.
Black plastic body with extending edge to protect lens.
Pivot base with M10 fixing screw.
Pivot range vertical 105°.

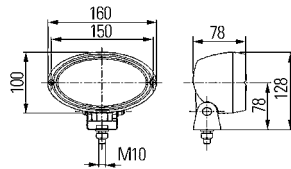

Part no.	Pk.	
1GA 996 161-291	1	FF® H3 work light with double reflector and 12V55W bulbs
Spare parts/Accessories:		
9GH 993 984-001	20	Cap for AMP plug connector
8GH 002 090-271	1	H3 bulb, 12V35W
8GH 002 090-133	1	12V55W
8GH 002 090-251	1	24V70W
8JD 008 151-011	10	Socket for AMP plug connector
8KW 701 235-033	100	Blade receptacles, 6.3 mm
8KB 990 299-001	1	2000 mm long connecting lead for AMP plug connector with cap
8HG 990 263-111	1	Mounting bracket for tubular mount on 15 mm - 28 mm dia. pipes

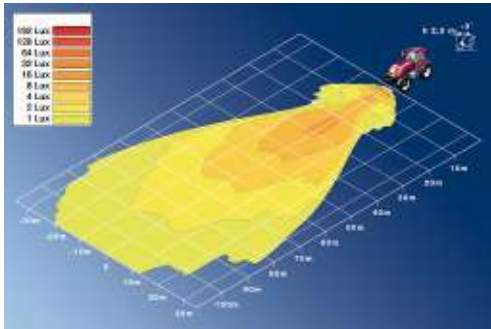

External-fitting work lights

Oval 100 with FF® reflector

Lens pattern for extremely wide and far-reaching illumination. With AMP plug connector and sealing cap. Light aperture: 130 x 75 mm.

Recommended angle of inclination: 4° - 10°. Reflector made of die-cast aluminium, glued to hardened glass lens. Black plastic body with extending edge to protect lens. Pivot base with M10 fixing screw. Pivot range vertical 105°. Type of protection: IP5K4K and IPX9K.

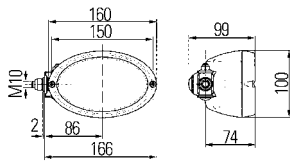
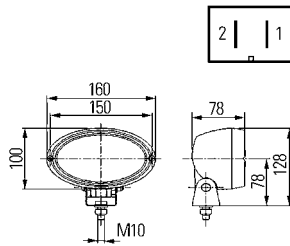

Part no.	Pk.	
1GA 996 161-131	1	FF® H3 work light, for upright or pendant mounting, with glass lens without optical pattern, double reflector and 12V55W bulbs
1GA 996 361-011	1	and 24V70W bulbs
1GA 996 161-331	1	FF® H3 work light, with side pivot base for left mounting, also suitable for mounting on the right when the unit is turned through 180°, lens without optical pattern, with double reflector and 12V55W bulbs
Spare parts/Accessories:		
9GH 993 984-001	20	Cap for AMP plug connector
8GH 002 090-271	1	H3 bulb,
8GH 002 090-133	1	12V35W
8GH 002 090-251	1	12V55W
8JD 008 151-011	1	24V70W
8KW 701 235-033	10	Socket for AMP plug connector
8KB 990 299-001	100	Blade receptacles, 6.3 mm
8HG 990 263-111	1	2000 mm long connecting lead for AMP plug connector with cap
	1	Mounting bracket for tubular mount on 15 mm - 28 mm dia. pipes

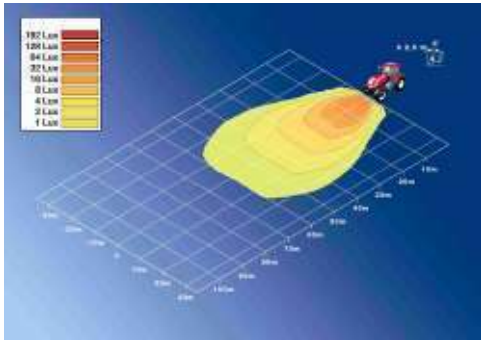

External-fitting work lights

Oval 100 Xenon Integral

Lens pattern for wide, close-range illumination.
With gas discharge bulb and DEUTSCH plug connector.
Light aperture: 130 x 75 mm.

Recommended angle of inclination: 8° - 15°.
 Reflector made of die-cast aluminium, glued to hardened glass lens.
 Black plastic body with extending edge to protect lens.
 Xenon-electronic unit 42W integrated into body.
 Without connecting lead (see accessories).
 Pivot range vertical 105°.
 Type of protection: IP5K4K and IPX9K.

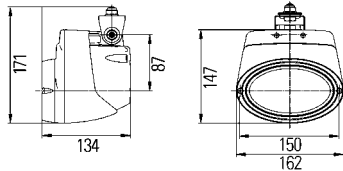
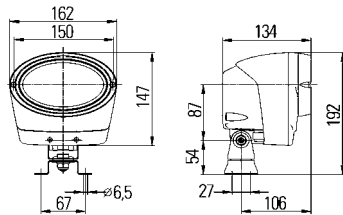

Part no.	Pk.	
1GA 996 261-511	1	Xenon work light with 12V ballast unit. Pivot base with bracket for four-point mounting made of stainless steel, for upright mounting
1GA 996 261-521	1	Pivot base with M10 fixing screw, for pendant mounting
8GS 009 028-021	1	Spare parts/Accessories: D1S gas discharge bulb, 35W
8KB 990 299-221	1	3700 mm long connecting lead with relay, 15A fuse and DEUTSCH plug connector, 12V
8HG 990 263-111	1	Mounting bracket for tubular mount on 15 mm - 28 mm dia. pipes

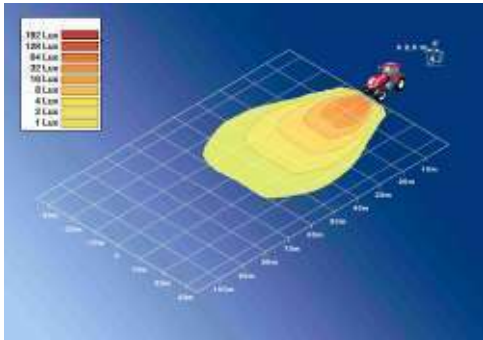

External-fitting work lights

Oval 100 Xenon Integral

Lens pattern for wide close-range illumination.

With gas discharge bulb.

Light aperture: 130 x 75 mm.

Recommended angle of inclination: 8° - 15°.

Reflector made of diecast aluminium, glued to hardened glass lens.

Black plastic body with extending edge to protect lens.

Xenon-electronic unit 42W integrated into body.

Without connecting lead (see accessories).

Pivot range vertical 105°.

Type of protection: IP5K4K and IPX9K.

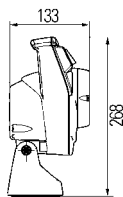
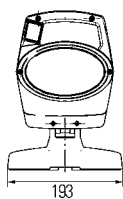
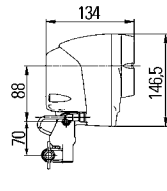
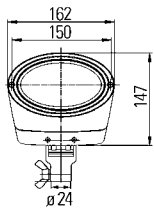
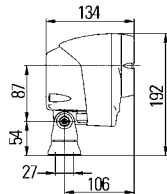
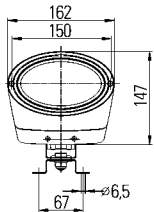

Part no.	Pk.	
1GA 996 261-531	1	Xenon work light with DEUTSCH plug connector, 24V ballast unit and black lens-retaining rim, pivot base with bracket for four-point mounting made of stainless steel. for upright mounting
1GA 996 261-691	1	for pendant mounting
1GA 996 261-561	1	Xenon work light with pivot base with bracket for four-point mounting made of stainless steel, for upright mounting, with AMP plug connector and and 12V ballast unit
1GA 996 261-571	1	and 24V ballast unit
1GA 996 261-701	1	Xenon work light with mounting bush for 24 mm dia. standard pin for upright mounting, with AMP plug connector and 24V ballast unit
1GA 996 261-711	1	Xenon work light with handle, switch and magnet base for upright mounting, with AMP plug connector and 12V ballast unit
8GS 009 028-021	1	Spare parts/Accessories: D1S gas discharge bulb, 35W 3700 mm long connecting lead with relay, 15A fuse and DEUTSCH plug connector,
8KB 990 299-221	1	12V
8KB 990 299-231	1	24V
8KB 990 299-121	1	3700 mm long connecting lead with relay, 15A fuse and AMP plug connector, 24V
8JD 008 151-011	10	Socket for AMP plug connector
8KW 701 235-033	100	Blade receptacles, 6.3 mm
8JS 711 687-821	1	Blade-type fuses, 15A (5 pcs.)
8HG 990 263-111	1	Mounting bracket for tubular mount on 15 mm - 28 mm dia. pipes

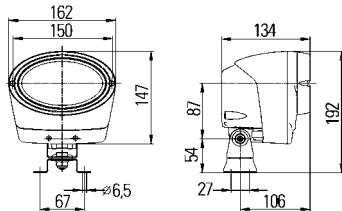
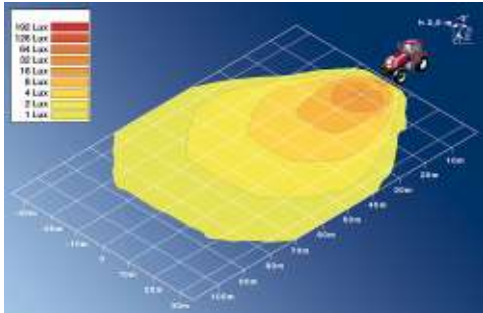

External fitting work lights for upright mounting

Oval 100 Xenon Integral

Lens pattern for wide off-road illumination.

With gas discharge bulb.

Light aperture: 130 x 75 mm.

Recommended angle of inclination: 3° - 10°.

Reflector made of diecast aluminium, glued to hardened glass lens.

Black plastic body with extending edge to protect lens.

Xenon-electronic unit 42W integrated into body.

Without connecting lead (see accessories).

Pivot base with bracket for four-point mounting

made of stainless steel.

Pivot range vertical 105°. Type of protection: IP5K4K and IPX9K.

Part no.	Pk.	
1GA 996 261-581	1	Xenon work light with AMP plug connector and 12V ballast unit
Spare parts/Accessories:		
8GS 009 028-021	1	D1S gas discharge bulb, 35W
8KB 990 299-121	1	3700 mm long connecting lead with relay,
8JD 008 151-011	1	15A fuse and AMP plug connector, 12V
8KW 701 235-033	10	Socket for AMP plug connector
8JS 711 687-821	100	Blade receptacles, 6.3 mm
8HG 990 263-111	1	Blade-type fuses, 15A (5 pcs.)
		Mounting bracket for tubular mount on 15 mm - 28 mm dia. pipes

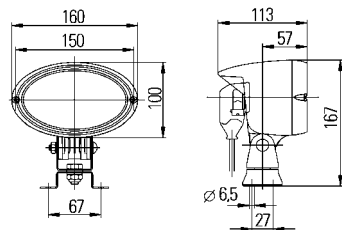
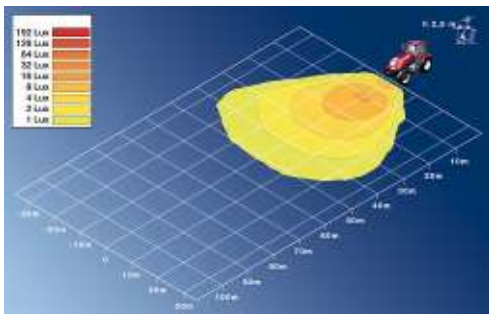

Oval 100 H9 with FF® reflector

Lens pattern for wide off-road illumination.

With 12V bulb, accessible from the outside.

Light aperture: 130 x 75 mm.

Recommended angle of inclination: 3° - 10°.

Reflector made of diecast aluminium, glued to hardened glass lens.

Black plastic body with extending edge to protect lens.

Vibration-damped pivot base with bracket for four-point mounting.

Pivot range vertical 105°.

With 2000 mm long connecting lead.

Type of protection: IP5K4K.

Part no.	Pk.	
1GA 996 161-391	1	FF®-H9 work light
Spare parts/Accessories:		
8GH 008 357-001	1	H9 bulb, 12V65W
9XD 990 298-001	5	Bracket for four-point fixing
8KB 990 299-311	1	2000 mm long connecting lead,
9GH 990 334-011	1	with plug for connecting the H9 bulb
8HG 990 263-111	1	Rubber cap for H9 socket
		Mounting bracket for tubular mount on 15 mm - 28 mm dia. pipes

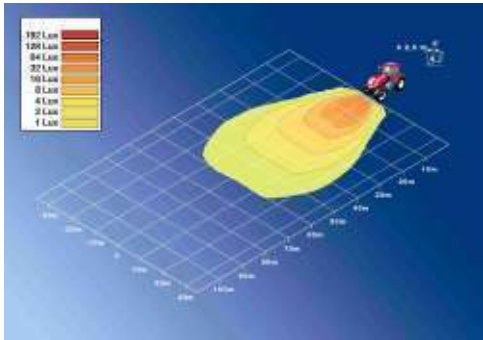

1GA 996 461-311

1

Xenon work light with 500 mm lead and 2-pole AMP plug for upright mounting, with 12V ballast unit

1GA 996 461-331

1

with 24V ballast unit



1GA 996 461-787

1

Xenon work light with 300 mm lead and 2-pole Deutsch plug for upright mounting, with 12V ballast unit

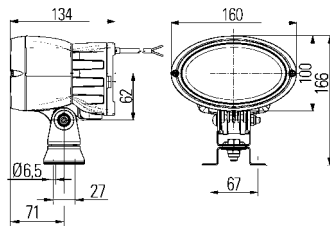

1GA 996 461-321

1

Xenon work light with 500 mm lead and 2-pole AMP plug for pendant mounting, with 12V ballast unit

1GA 996 461-341

1

with 24V ballast unit



1GA 996 461-797

1

Xenon work light with 300 mm lead and 2-pole Deutsch plug for pendant mounting, with 12V ballast unit

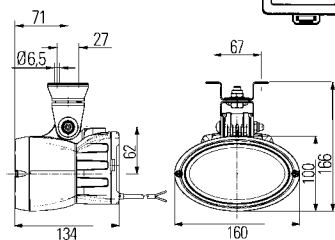

8GS 009 028-021

1

Spare parts:
D1S gas discharge bulb, 35W

External-fitting work lights

Oval 100 Xenon-Powerpack

Lens pattern for wide close-range illumination.

With gas discharge bulb. Light aperture: 130 x 75 mm.

Recommended angle of inclination: 3° - 10°.

Reflector made of diecast aluminium, glued to hardened glass lens.

Black plastic body with red extending edge to protect lens.

Rear of body made of black diecast aluminium.

Xenon electronic unit integrated into body.

Vibration-damped pivot base with bracket for four-point mounting.

Additionally enclosed, displaceable bracket for single-point attachment.

Type of protection: IP5K4K. System capacity: 42W.

Part no.	Pk.	
1GA 996 461-311	1	Xenon work light with 500 mm lead and 2-pole AMP plug for upright mounting, with 12V ballast unit
1GA 996 461-331	1	with 24V ballast unit
1GA 996 461-787	1	Xenon work light with 300 mm lead and 2-pole Deutsch plug for upright mounting, with 12V ballast unit
1GA 996 461-321	1	Xenon work light with 500 mm lead and 2-pole AMP plug for pendant mounting, with 12V ballast unit
1GA 996 461-341	1	with 24V ballast unit
1GA 996 461-797	1	Xenon work light with 300 mm lead and 2-pole Deutsch plug for pendant mounting, with 12V ballast unit
8GS 009 028-021	1	Spare parts: D1S gas discharge bulb, 35W

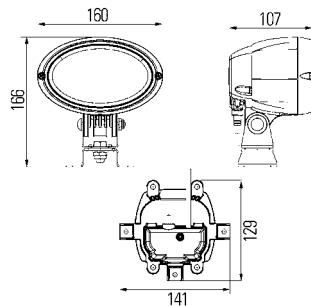
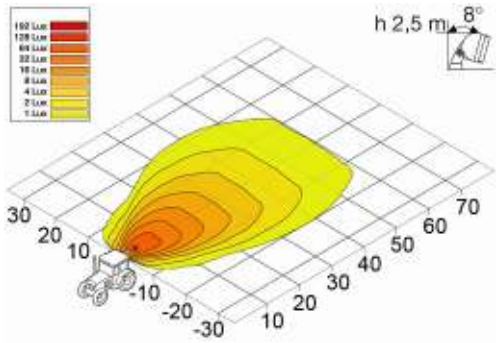

External-fitting work lights

Oval 100 Xenon

Lens pattern for wide close-range illumination.

With gas discharge bulb. Light aperture: 130 x 75 mm.

Recommended angle of inclination: 3° - 10°.

Reflector made of diecast aluminium, glued to hardened glass lens.

Black plastic body and red lens-retaining rim with red extending edge to protect lens.

Rear of housing made of black diecast aluminium with 100 mm lead and 2-pole AMP plug connector.

Work light permanently connected to ballast unit by a 500 mm long lead.

Vibration-damped pivot base with bracket for four-point mounting.

Type of protection: IP5K9K. System capacity: 50W.

Part no.	Pk.	
1GA 996 461-591	1	Xenon work light with 500 mm lead and 2-pole AMP plug for upright mounting, with 12V ballast unit
1GA 996 461-601	1	with 24V ballast unit
8GS 009 028-021	1	Spare parts: D1S gas discharge bulb, 35W

Built-in headlights

Oval 120

With H4 light, position light, 12V bulbs and protection cap.

Light aperture: 161 x 100 mm.

Black plastic mounting frame with inclination adjustment 4°.

Reflector made of plastic, glued to non-patterned glass lens.

Two M5 x 35 mm fixing screws.

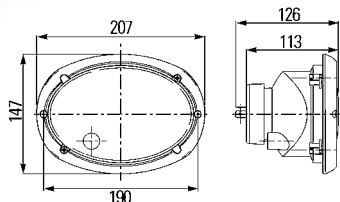

Part no.	Pk.	
1LB 996 157-201	1	H4 built-in headlight
		Spare parts/Accessories:
8GJ 002 525-131	1	H4 bulb, 12V60/55W
8GJ 002 525-251	1	24V75/70W T4W bulb,
8GP 002 067-121	10	12V4W
8GP 002 067-241	10	24V4W

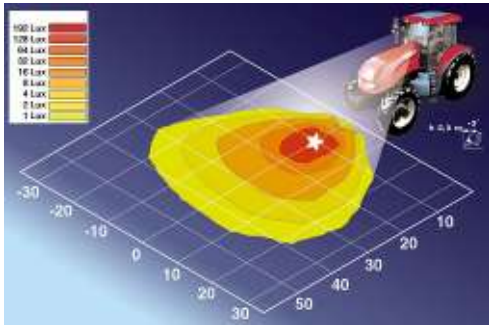

Built-in work lights

Oval 120 Xenon

Lens pattern for off-road illumination.

With gas discharge bulb. Light aperture: 161 x 100 mm.

Recommended angle of inclination: 3° - 10°.

Lens with plastic reflector bonded.

Black plastic mounting frame with inclination adjustment 4°.

With two fixing screws 50 x 35 mm.

The work light is firmly connected to the ballast unit by 500 mm long lead.

Type of protection: IP5K4K.

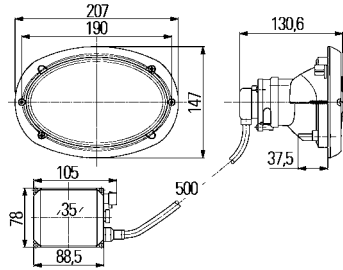

Part no.	Pk.	
1GB 996 158-081	1	Xenon-work light with 24V ballast unit
		Spare parts:
5DV 007 810-171	1	Ballast unit, 24V
8GS 007 949-101	1	D2S gas discharge bulb, 35W
8JD 156 151-807	1	Socket set for ballast unit (20 pcs.)

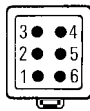
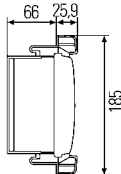
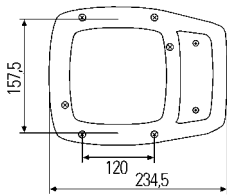

Built-in headlights

Module 120

With H7 dipped-beam light, H3 driving-beam light, position light and indicator light (category 1 and 1a).

Light aperture: 120 x 120 mm.

With black rubber seal for sealing installation opening.

Black plastic lens-retaining rim with extending edge to protect lens.

Lens with plastic reflector bonded.

Type of protection: IPX9K.

Only for spare parts requirement.

Part no.	Pk.	
1LA 996 074-037	30	H7/H3 built-in headlight with grommet, left
1LA 996 074-047	30	right
1LA 996 074-197	30	H7/H3 built-in headlight with 24V bulbs and lead with 6 pole DEUTSCH plug connector, left
1LA 996 074-207	30	right
9EL 990 186-001	4	Spare parts/Accessories: Lens for indicator light
8GH 007 157-121	1	H7 bulb,
8GH 007 157-241	1	12V55W
8GH 002 090-133	1	24V70W
8GH 002 090-251	1	H3 bulb,
8GP 002 067-121	10	12V55W
8GP 002 067-241	10	24V70W
8GA 002 073-121	10	T4W bulb,
8GA 002 073-241	10	12V4W
	10	24V4W
	10	P21W bulb,
	10	12V21W
	10	24V21W

Headlights for upright mounting

Module 120

With H7 dipped-beam light, H3 driving-beam light, position light and attached amber indicator light with one lens each toward front and rear (category 1, 1a and 5).
Light aperture: 120 x 120 mm.

Lens with plastic reflector bonded. Black plastic body with extending edge to protect lens
Universal bracket with M12 fixing screw.
Type of protection: IPX9K. Only for spare parts requirement.

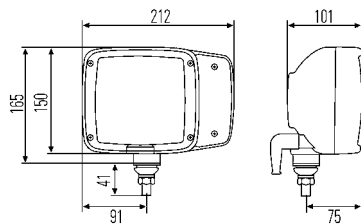
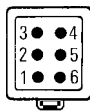
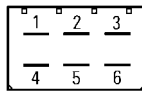

Part no.	Pk.	
1LA 993 975-037	40	H7/H3 built-in headlight with 6-pole AMP plug connector and 12V bulbs, left
1LA 993 975-047	40	right
1LA 993 975-117	40	H7/H3 built-in headlight with 6-pole DEUTSCH plug connector and 12V bulbs, left
Spare parts/Accessories:		
1LA 990 185-011	1	Light unit
9EL 990 186-001	4	Lens for indicator light, front
8GH 007 157-121	1	H7 bulb, 12V55W
8GH 007 157-241	1	24V70W H3 bulb, 12V55W
8GH 002 090-133	1	12V55W
8GH 002 090-251	1	24V70W T4W bulb, 12V4W
8GP 002 067-121	10	12V4W
8GP 002 067-241	10	24V4W P21W bulb, 12V21W
8GA 002 073-121	10	12V21W
8GA 002 073-241	10	24V21W 6-pole socket for AMP plug connector
8JD 008 151-051	10	6-pole socket for AMP plug connector
9GH 993 988-007	1	Rubber cap for AMP plug connector
8KW 701 235-033	100	Blade receptacles, 6.3 mm
9GH 990 316-031	20	Rubber cap for Deutsch plug connector

Module 120

With H7 dipped-beam light, H3 driving-beam light and position light.
Light aperture: 120 x 120 mm.

Lens with plastic reflector bonded.
Black plastic body and lens-retaining rim with extending edge to protect lens.
Universal bracket with M12 fixing screw.
Type of protection: IPX9K. Only for spare parts requirement.

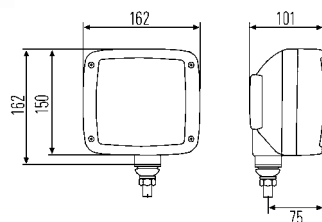
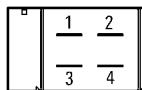

Part no.	Pk.	
1LA 996 127-017	54	H7/H3 built-in headlight with AMP plug connector, 4-pole and 12V bulbs
Spare parts/Accessories:		
1LA 990 185-011	1	Light unit
8GH 007 157-121	1	H7 bulb, 12V55W
8GH 007 157-241	1	24V70W H3 bulb, 12V55W
8GH 002 090-133	1	12V55W
8GH 002 090-251	1	24V70W T4W bulb, 12V4W
8GP 002 067-121	10	12V4W
8GP 002 067-241	10	24V4W
8JD 008 151-041	10	4-pole socket
9GH 993 988-007	1	Rubber cap for AMP plug connector
8KW 701 235-033	100	Blade receptacles, 6.3 mm

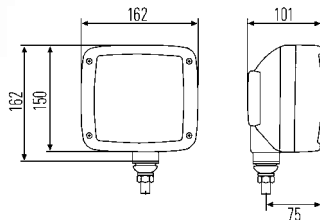
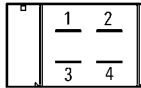
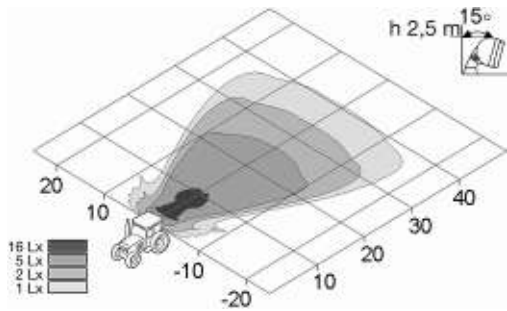

External fitting work lights for upright mounting

Module 120 with FF reflector

Lens pattern for long-range illumination.

With AMP plug connector, 4-pole. Light aperture: 120 x 120 mm.

Recommended angle of inclination: 20°.

Lens with plastic reflector bonded.

Black plastic body and lens-retaining rim with extending edge to protect lens.

Universal bracket with M12 fixing screw.

Type of protection: IPX9K.

Part no.	Pk.	
1GA 996 140-021	1	FF®-H3 work light
Spare parts/Accessories:		
		H3 bulb,
8GH 002 090-271	1	12V35W
8GH 002 090-133	1	12V55W
		4-pole socket
8JD 008 151-041	10	for AMP plug connector
9GH 993 988-007	1	Rubber cap for AMP plug connector
8KW 701 235-033	100	Blade receptacles, 6.3 mm

Built-in headlights

Module 6213

With H4 light and protection cap.

Light aperture: 148 x 84 mm.

Lens with steel reflector bonded.

Mounting frame made of black plastic. Inclination 6°.

Mounting area: 148 x 88 mm. Type of protection: IP5K4K.

Only for spare parts requirement.

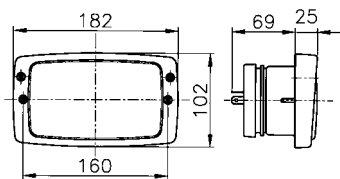

Part no.	Pk.	
1LB 006 213-057	30	H4 built-in headlight without position light, 12V
1LB 006 213-047	30	with position light, 12V
Accessories:		
		H4 bulb,
8GJ 002 525-131	1	12V60/55W
8GJ 002 525-251	1	24V75/70W
		T4W bulb,
8GP 002 067-121	1	12V4W
8GP 002 067-241	1	24V4W

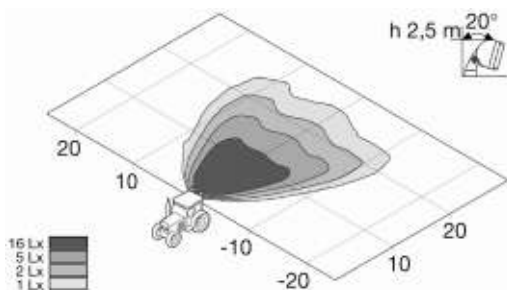
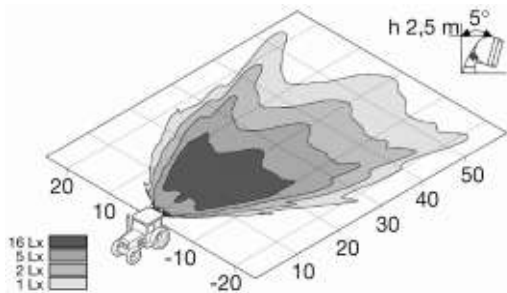
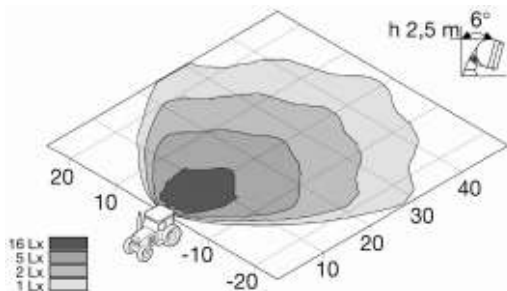
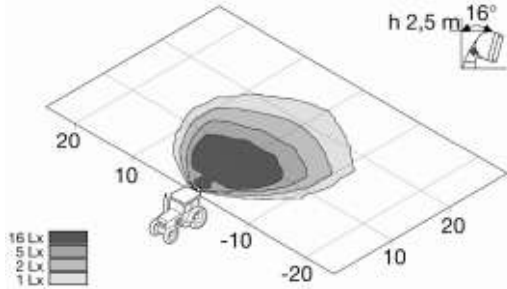
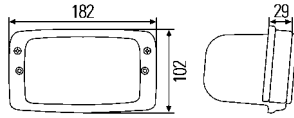

Work lights for horizontal flush mounting

Module 6213 Double Beam with FF® reflector

With grommet. Light aperture: 148 x 84 mm.

Double reflector made of diecast aluminium, glued to glass lens. Black plastic body and supporting frame, with pan-head tapping screws made of stainless steel 4.2 x 45 mm.

Distance between screws 160 mm.

Inclination (6° up and downwards) can be adjusted.

Mounting area: 148 x 88 mm.

With 250 mm long connecting lead. Type of protection: IP5K4K.

Part no.	Pk.	
1GB 996 080-001	1	FF®-H3 work light for front or rear flush mounting in vehicle roof. With lens pattern for object illumination for vertical surfaces. Recommended angle of inclination: 15° - 35°, without bulbs
1GB 996 080-011	1	Lens pattern for ground illumination. Recommended angle of inclination: 5° - 15°, with 2 bulbs 12V55W
1GB 996 080-021	1	FF®-H3 work light for front flush mounting in vehicle roof. Light falling on the engine of the bon net reduced to a minimum in order to avoid dazzling off the driver. Lens pattern for far-reaching off-road illumination. Recommended angle of inclination: 2° - 10°, without bulbs
1GB 996 080-031	1	Lens pattern for ground illumination. Recommended angle of inclination: 20° - 30°, without bulbs
8GH 002 090-271	1	Spare parts/Accessories: H3 bulb, 12V35W 12V55W 24V70W 1 Rubber body for sealing installation opening Black plastic body with mounting bracket for use light as external-fitting work light with grommet 4-pole socket for AMP plug connector 100 Blade receptacles, 6.3 mm 5 Bracket for four-point mounting
8GH 002 090-133	1	
8GH 002 090-251	1	
9BG 993 345-001	1	
9BG 990 178-011	1	
8JD 008 151-041	10	
8KW 701 235-033	100	
9XD 990 298-001	5	

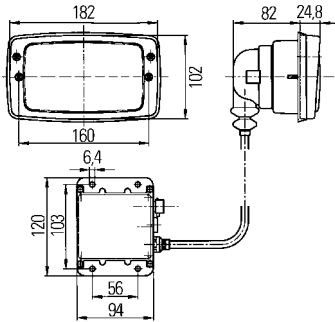

Built-in work lights

Module 6213-Xenon

with 12V ballast unit and gas discharge bulb.

Light aperture: 148 x 84 mm.

Recommended angle of inclination: 10° - 20°.

Lens with plastic reflector bonded.

With pan-head tapping screws made of stainless steel 4.2 x 45 mm.

Inclination (6° up and downwards) can be adjusted.

Rubber body for sealing installation opening 148 x 88 mm.

The ballast unit is firmly connected to work light by a 300 mm long lead.

Type of protection: IP5K4K.

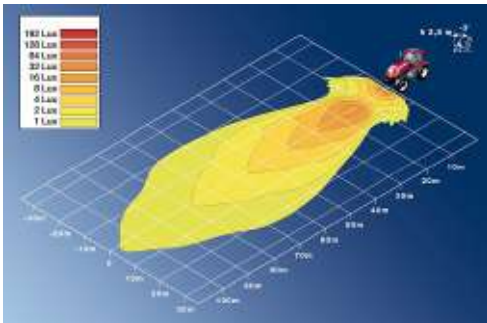
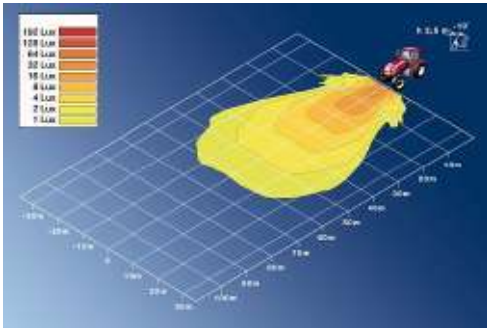

Part no.	Pk.	
1GB 996 147-011	1	Xenon-work light with 3700 mm long connection lead, relay and 15A fuse, with red supporting frame and lens pattern for long-range illumination.
1GB 996 147-101	1	without connection lead, with black supporting frame and lens pattern for long-range illumination
8GS 007 949-101	1	Spare parts/Accessories: D2S gas discharge bulb, 35W
9BG 990 297-001	1	body for ballast unit, 12V
8JS 711 687-821	1	Blade-type fuses, 15A (5 pcs.)
8KB 149 147-001	1	3000 mm long connection lead from ballast unit to battery, with relay and fuse, 12V

Built-in work lights

Module 6213

Light aperture: 148 x 84 mm.

Recommended angle of inclination: 10° - 20°.

Lens with metal reflector bonded.

Black plastic supporting frame with pan-head tapping screws made of stainless steel 4.2 x 45 mm.

Inclination (6° up and downwards) can be adjusted.

Mounting area: 148 x 88 mm. Type of protection: IP5K4K.

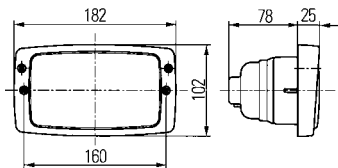
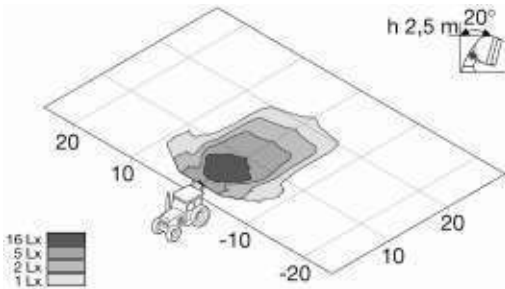
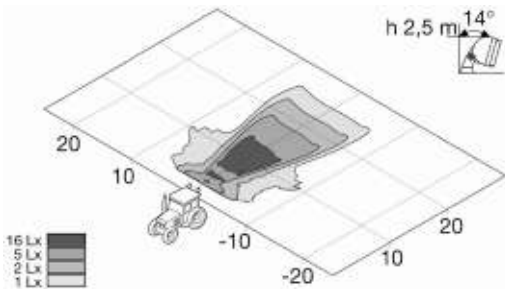

Part no.	Pk.	
1GB 006 213-101 1GB 006 213-107	1 30	H3 work light, 12V/24V with reflector made of sheet metal and lens pattern for far-reaching illumination
1GB 006 213-111 1GB 006 213-117	1 30	lens pattern for close-range illumination
1GD 996 018-541	1	H3 work light, 12V/24V with reflector made of plastic and lens pattern for close-range illumination
8GH 002 090-271 8GH 002 090-133 8GH 002 090-251	1 1 1	Accessories: H3 bulb, 12V35W 12V55W 24V70W Rubber body for sealing installation opening, for -101/-107/-111/-117
9BG 993 345-001 9BG 990 042-061	1 1	for -541 Black plastic body with mounting bracket for use light as external-fitting work light with grommet
9BG 990 178-011	1	4-pole socket
8JD 008 151-041 8KW 701 235-033 9XD 990 298-001	10 100 5	for AMP plug connector Blade receptacles, 6.3 mm Bracket for four-point fixing

Work lights for upright or pendant mounting

Module 6213

Lens pattern for close-range illumination.
With grommet and vibration damping. Light aperture: 148 x 84 mm.
 Recommended angle of inclination: 10° - 20°.
 Lens with metal reflector bonded.
 Black plastic body and lens-retaining rim.
 Pivot base with bracket for four-point mounting.
 Type of protection: IP5K4K.

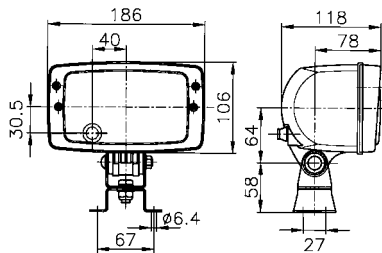
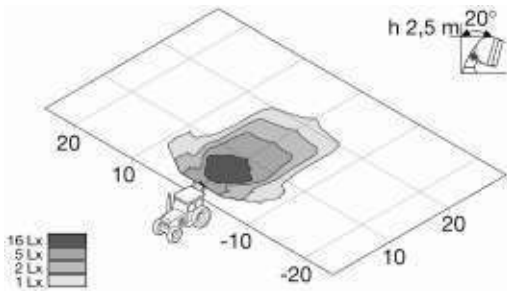

Part no.	Pk.	
1GB 996 213-511	1	H3 work light
Spare parts/Accessories:		
1GB 006 213-111	1	Light unit with lens-retaining rim
9XD 990 298-001	5	Bracket for four-point fixing
		H3 bulb,
8GH 002 090-271	1	12V35W
8GH 002 090-133	1	12V55W
8GH 002 090-251	1	24V70W

Headlights for upright or pendant mounting

7145

With H4 light and position light.
Light aperture: 148 x 84 mm.
 Reflector made of sheet metal, glued to glass lens.
 Body and mounting frame made of black plastic.
 Pivot base with M10 fixing screw.

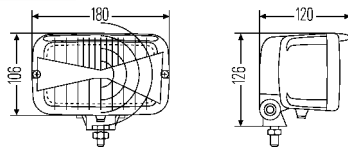

Part no.	Pk.	
1LB 007 145-047	36	H4 external-fitting headlight
Accessories:		
8GJ 002 525-131	1	H4 bulb, 12V60/55W
8GP 002 067-121	10	T4W bulb, 12V4W

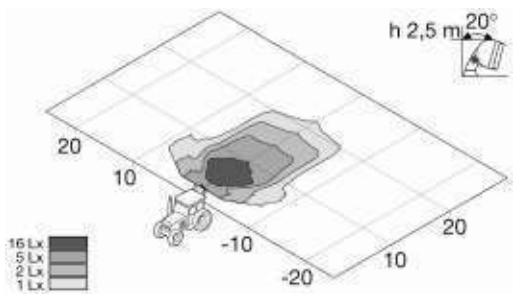

Work lights for upright or pendant mounting

7145

Lens pattern for ground illumination.

Light aperture: 148 x 84 mm.

Recommended angle of inclination: 10° - 20°.

Reflector made of sheet metal, glued to glass lens.

Black plastic body and lens-retaining rim.

Pivot base with M10 fixing screw

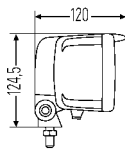
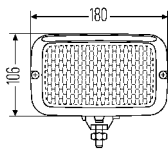

Part no.	Pk.	
1GB 007 145-101	1	H3 work light
1GB 007 145-107	36	
Accessories:		
		H3 bulb,
8GH 002 090-271	1	12V35W
8GH 002 090-133	1	12V55W
8GH 002 090-251	1	24V70W

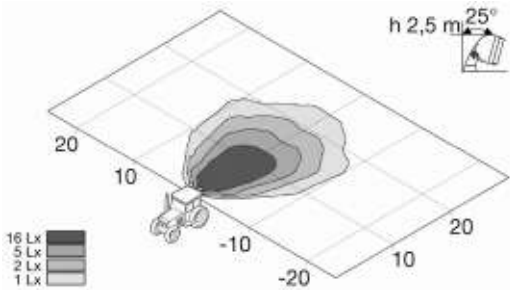

Work lights for upright or pendant mounting

Double-Beam with FF@-reflector

Lens pattern for intensive close-range illumination.

With grommet. Light aperture: 136 x 88 mm.

Recommended angle of inclination: 25° - 35°.

Double reflector made of diecast aluminium, glued to glass lens.

Black plastic body with extending edge to protect lens.

With 250 mm long silicone connection lead.

Pivot base with bracket for four-point mounting.

Without vibration damping. Type of protection: IP5K4K.



Part no.	Pk.	
1GA 006 991-021	1	FF@-H3 work light with handle
1GA 006 991-091	1	without handle
Spare parts/Accessories:		
1GA 998 524-001	1	Light unit
9XD 990 298-001	5	Bracket for four-point fixing
8GH 002 090-271	1	12V35W
8GH 002 090-133	1	12V55W
8GH 002 090-251	1	24V70W

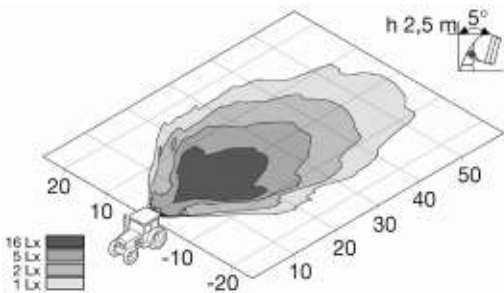

Double-Beam with FF@-reflector

Lens pattern for far-reaching off-road illumination.

With grommet. Light aperture: 136 x 88 mm.

Recommended angle of inclination: 5° - 15°.

Double reflector made of diecast aluminium, glued to glass lens.

Black plastic body with extending edge to protect lens.

With 250 mm long silicone connection lead.

Pivot base with bracket for four-point mounting.

Without vibration damping. Type of protection: IP5K4K.



Part no.	Pk.	
1GA 006 991-061	1	FF@-H3 work light with handle
1GA 006 991-051	1	without handle
Spare parts/Accessories:		
9XD 990 298-001	5	Bracket for four-point fixing
8GH 002 090-271	1	12V35W
8GH 002 090-133	1	12V55W
8GH 002 090-251	1	24V70W

Accessories see page 4.123 - 4.125

Work lights for upright or pendant mounting

Double-Beam with FF®-reflector

Lens pattern for wide ground illumination.

With grommet. Light aperture: 136 x 88 mm.

Recommended angle of inclination: 15° - 25°.

Double reflector made of diecast aluminium, glued to glass lens.

Black plastic body with extending edge to protect lens.

With 250 mm long silicone connection lead.

Pivot base with bracket for four-point mounting.

Without vibration damping. Type of protection: IP5K4K.

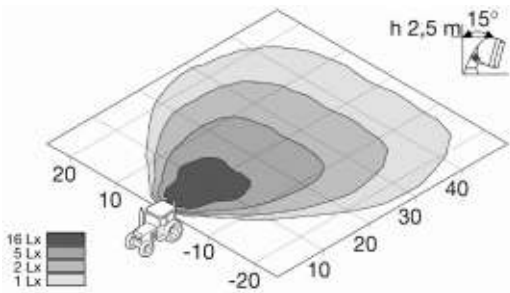

Part no.	Pk.	
1GA 006 991-031	1	FF®-H3 work light with handle
1GA 006 991-041	1	without handle
Spare parts/Accessories:		
1GA 998 524-011	1	Light unit
9XD 990 298-001	5	Bracket for four-point fixing
8GH 002 090-271	1	12V35W
8GH 002 090-133	1	12V55W
8GH 002 090-251	1	24V70W

Double-Beam with FF®-reflector

Lens pattern for object illumination for vertically surfaces.

With grommet. Light aperture: 136 x 88 mm.

Recommended angle of inclination:

for vertically surfaces 0° - 5°, for horizontally surfaces 25° - 45°.

Double reflector made of diecast aluminium, glued to glass lens.

Black plastic body with extending edge to protect lens.

With 250 mm long silicone connection lead.

Pivot base with bracket for four-point mounting.

Without vibration damping. Type of protection: IP5K4K.

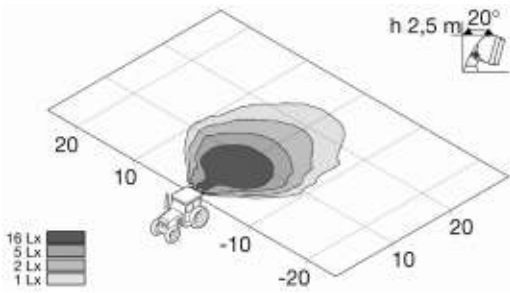

Part no.	Pk.	
1GA 006 991-081	1	FF®-H3 work light with handle
1GA 006 991-071	1	without handle
Spare parts/Accessories:		
9XD 990 298-001	5	Bracket for four-point fixing
8GH 002 090-271	1	12V35W
8GH 002 090-133	1	12V55W
8GH 002 090-251	1	24V70W



Work Lights

Master 5060

Lens pattern for far-reaching illumination.
With grommet. Light aperture: 135 x 75 mm.
 Recommended angle of inclination: 15° - 20°.
 Reflector made of sheet steel, glued to glass lens.
 Black plastic body with extending edge to protect lens.
 Type of protection: IP5K4K.

Part no.	Pk.	
1GA 005 060-001	1	H3 work light with pivot base with M10 fixing screw for upright or pendant mounting
Spare parts:		
1GA 132 459-011	1	Light unit
9AG 132 453-005	5	Lens-retaining rim H3 bulb,
8GH 002 090-271	1	12V35W
8GH 002 090-133	1	12V55W
8GH 002 090-251	1	24V70W



Master 5060

Lens pattern for close-range illumination.
With grommet. Light aperture: 135 x 75 mm.
 Recommended angle of inclination: 15° - 20°.
 Reflector made of sheet steel, glued to glass lens.
 Black plastic body with extending edge to protect lens.
 Type of protection: IP5K4K.

Part no.	Pk.	
1GA 005 060-041	1	H3 work light with pivot base with M10 fixing screw for upright or pendant mounting
1GA 005 060-337	30	H3 built-in work light with 2 fixing screws 3.5 x 25 mm and 12V55W bulb. Mounting area: 152 x 92 mm
Spare parts/Accessories:		
9AG 132 453-005	5	Lens-retaining rim H3 bulb,
8GH 002 090-271	1	12V35W
8GH 002 090-133	1	12V55W
8GH 002 090-251	1	24V70W

Work lights for upright or pendant mounting

Picador 6876 with FF® reflector

Lens pattern for ground illumination.

With grommet. Light aperture: 125 x 75 mm.

Recommended angle of inclination: 20° - 25°.

Lens with plastic reflector bonded.

Black plastic body and lens-retaining rim.

Lens-retaining rim with extending edge to protect lens.

Universal bracket with M10 fixing screw.

Pivot range: horizontal 130°, vertical 90°. Type of protection: IP5K4K.

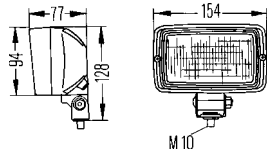

Part no.	Pk.	
1GA 006 876-001	1	FF®-H3 work light with rotary pivot base
		Spare parts/Accessories:
		H3 bulb,
8GH 002 090-271	1	12V35W
8GH 002 090-133	1	12V55W
8GH 002 090-251	1	24V70W
		Mounting bracket for tubular mount on
8HG 990 263-111	1	15 mm - 28 mm dia. pipes
8HG 004 806-001	1	Magnet bracket
9XD 130 261-001	1	Bracket for four-point fixing

Picador 8522 with FF® reflector

Lens pattern for ground illumination.

Light aperture: 125 x 75 mm.

Recommended angle of inclination: 20° - 25°.

Lens with plastic reflector bonded.

Black plastic body and lens-retaining rim.

Lens-retaining rim with extending edge to protect lens.

Universal bracket with M10 fixing screw

Pivot range: horizontal 130°. Type of protection: IP5K4K.

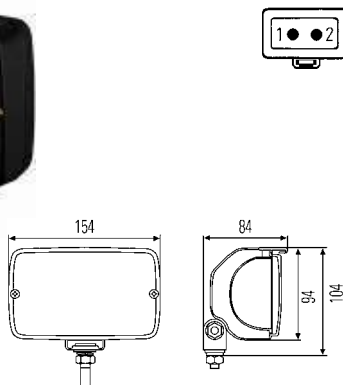

Part no.	Pk.	
1GA 998 522-011	1	FF®-H3 work light with pivot base and grommet, without bulb
		with pivot base, 12V55W bulb, 150 mm lead and DEUTSCH plug connector
1GA 998 522-407	350	
		Spare parts/Accessories:
		H3 bulb,
8GH 002 090-271	1	12V35W
8GH 002 090-133	1	12V55W
8GH 002 090-251	1	24V70W
		Mounting bracket for tubular mount on
8HG 990 263-111	1	15 mm - 28 mm dia. pipes
8HG 004 806-001	1	Magnet bracket
9XD 130 261-001	1	Bracket for four-point fixing

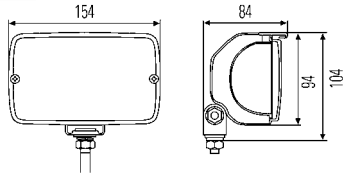
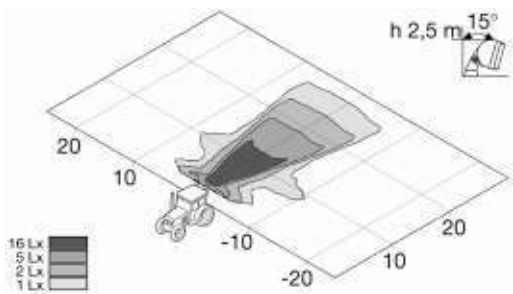

Work lights for upright or pendant mounting

Picador 6876 with FF® reflector

Lens pattern for long-range illumination.

Recommended angle of inclination: 15° - 20°.

Lens with plastic reflector bonded.

Black plastic body and lens-retaining rim.

Lens-retaining rim with extending edge to protect lens.

Universal bracket with M10 fixing screw

Pivot range: horizontal 130°. Type of protection: IP5K4K.

Part no.	Pk.	
1GB 996 102-101	1	FF®-H3 work light with pivot base
		Spare parts/Accessories:
		H3 bulb,
8GH 002 090-271	1	12V35W
8GH 002 090-133	1	12V55W
8GH 002 090-251	1	24V70W
8HG 990 263-111	1	Mounting bracket for tubular mount on 15 mm - 28 mm dia. pipes
8HG 004 806-001	1	Magnet bracket
9XD 130 261-001	1	Bracket for four-point fixing

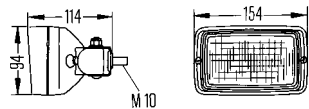

External-fitting work lights

Picador 6875 with FF® reflector

Lens pattern for ground illumination.

With grommet. Light aperture: 125 x 75 mm.

Recommended angle of inclination: 20° - 25°.

Lens with plastic reflector bonded.

Black plastic body and lens-retaining rim.

Lens-retaining rim with extending edge to protect lens.

Universal side bracket with M10 mounting screw for attachment to vertical surfaces.

Pivot range: horizontal 150°, vertical 90°. Type of protection: IP5K4K.

Part no.	Pk.	
1GA 006 875-001	1	FF®-H3 work light with side rotary pivot base
		Spare parts:
		H3 bulb,
8GH 002 090-271	1	12V35W
8GH 002 090-133	1	12V55W
8GH 002 090-251	1	24V70W

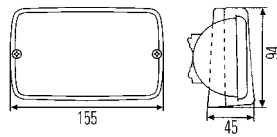

Built-in work lights

Picador 6082 with FF® reflector

Lens pattern for ground illumination.

Light aperture: 125 x 75 mm.

Recommended angle of inclination: 20° - 25°.

Lens with plastic reflector bonded.

Black plastic lens-retaining rim.

Lens-retaining rim with extending edge to protect lens.

With two 3.9 x 55 mm fixing screws. Distance between screws: 142 mm.

Foam rubber seal for sealing dust and water-tight to outside on even attachment surfaces. Front inclination 5.2°.

Mounting aperture: 130 x 76 mm. Type of protection: IP5K4K.

Part no.	Pk.	
1GA 996 082-001	1	FF®-H3 work light
Accessories:		
		H3 bulb,
8GH 002 090-271	1	12V35W
8GH 002 090-133	1	12V55W
8GH 002 090-251	1	24V70W

External-fitting work lights

Flatbeam LED

Lens pattern for close-range illumination.

Light aperture: 165 x 90 mm. With 60 LEDs 11W and 2000 mm lead.

Plastic body and reflector.

Plastic lens without optical pattern.

2 fixing screws M5.

Voltage range: 12V - 24V.

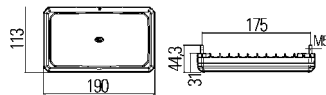
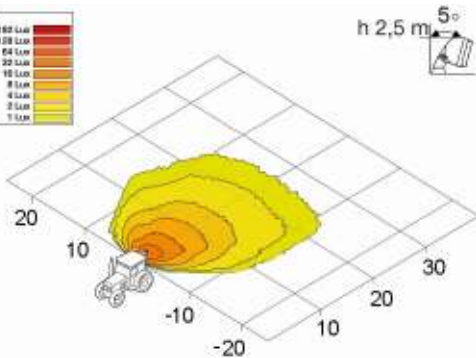
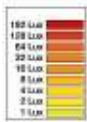

Part no.	Pk.	
1GD 996 193-001	1	LED work light

Light aperture: 172 x 86 mm.

Black plastic body.

For Fendt.

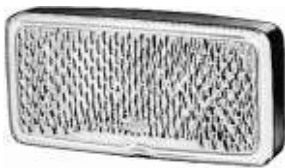

Part no.	Pk.	
1GD 003 690-287	1	H3 work light
Accessories:		
		H3 bulb,
8GH 002 090-271	1	12V35W
8GH 002 090-133	1	12V55W
8GH 002 090-251	1	24V70W

Work lights for upright or pendant mounting

Torero 5700

Lens pattern for close-range illumination.

Light aperture: 195 x 96 mm.

Recommended angle of inclination: 15° - 25°.

Reflector made of sheet metal, glued to glass lens.

Black plastic body.

Pivot base with M10 fixing screw.

Type of protection: IP5K4K.

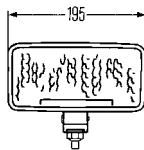
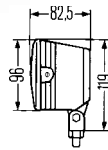
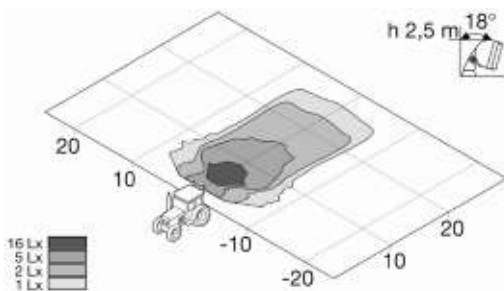

Part no.	Pk.	
1GD 005 700-501	1	H3 work light
Spare parts/Accessories:		
		H3 bulb,
8GH 002 090-271	1	12V35W
8GH 002 090-133	1	12V55W
8GH 002 090-251	1	24V70W

3590

Lens pattern for close-range illumination.

With grommet. Light aperture: 195 x 96 mm.

Black plastic body.

Pivot base with M10 fixing screw.

Type of protection: IP5K4K.

For Bomag and John Deere.

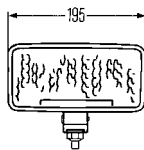
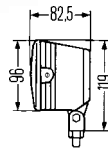
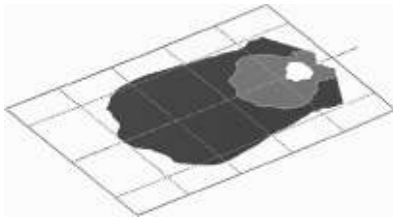

Part no.	Pk.	
1GD 003 590-701	1	H3 work light
Spare parts/Accessories:		
		H3 bulb,
8GH 002 090-271	1	12V35W
8GH 002 090-133	1	12V55W
8GH 002 090-251	1	24V70W

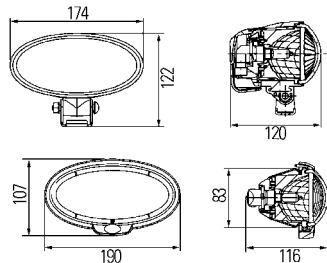
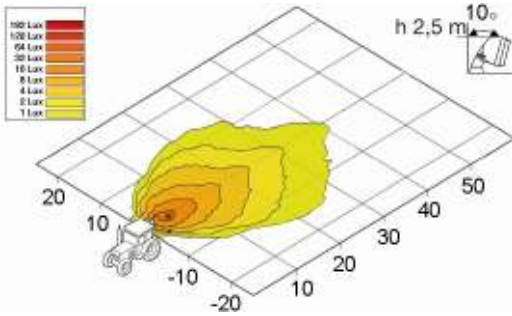

External-fitting or built-in work lights

Oval 90 HB3

Lens pattern for close-range illumination.
 With 12V bulb. Light aperture: 130 x 75 mm.
 Recommended angle of inclination: 3° - 10°.
 Reflector made of diecast aluminium,
 glued to hardened glass lens.
 Black plastic housing.

Part no.	Pk.	
1GB 996 186-051	1	HB3 work light with U-bracket and 10.2 mm dia hole for fixing screw, for upright mounting
1GB 996 186-061	1	with clamp fixing for flush mounting
8GH 005 635-181	1	Spare parts: HB3-LL-bulb, 12V60W

External-fitting work lights

ECO 21

Lens pattern for close-range illumination.
 Light aperture: 88 x 88 mm.
 Lens with plastic reflector bonded.
 Black plastic body.
 Pivot base with M10 fixing screw.
 With 200 mm connection lead.
 Bulb accessible from the outside.
 Type of protection: IP5K9K.

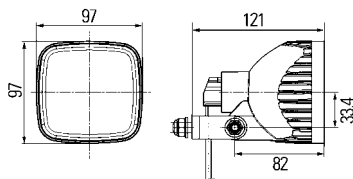

Part no.	Pk.	
1GA 996 179-021	1	P21W work light with 12V bulb
1GA 996 179-001	1	with 24V bulb
8GA 002 073-121	1	Spare parts: P21W bulb, 12V
8GA 002 073-241	1	24V

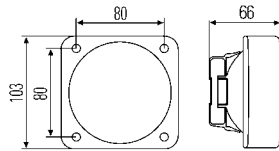
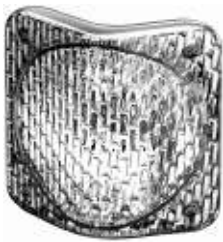

Built-in work lights

For installation on side next to headlight.
With 12V55W bulb.

For illumination to front and side.
With four 3.9 x 13 fixing screws.

Part no.	Pk.	
1GA 996 020-001	1	H3 work light
Spare parts/Accessories:		
		H3 bulb,
8GH 002 090-271	1	12V35W
8GH 002 090-133	1	12V55W

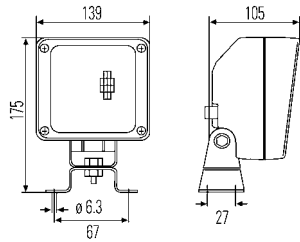

Work Lights for upright, pendant or side mounting

AS 200 with FF®-reflector

With AMP plug connector and protection cap.
Light aperture: 123 x 123 mm.

Black plastic body and lens-retaining rim.
Lens-retaining rim with extending edge to protect lens.
Vibration-damped pivot base with bracket for four-point mounting.
Type of protection: IP5K4K.

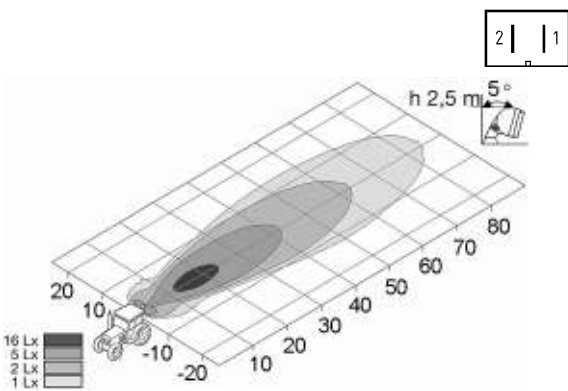
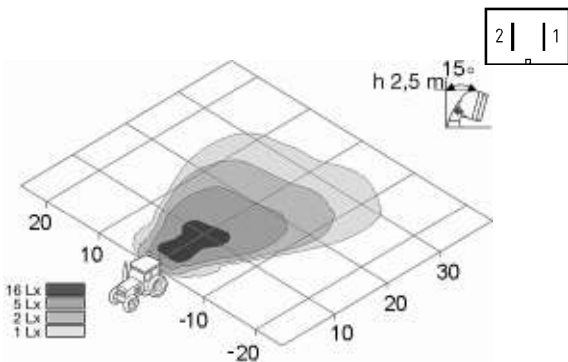

Part no.	Pk.	
1GA 998 532-011	1	FF®-H3 work light, recommended angle of inclination: 15° - 25°, with lens pattern for ground illumination
1GA 998 532-081	1	recommended angle of inclination: 5°, with lens pattern for far-reaching illumination
Spare parts/Accessories:		
8HG 990 263-111	1	Mounting bracket for tubular mount on 15 mm - 28 mm dia. pipes
		H3 bulb,
8GH 002 090-271	1	12V35W
8GH 002 090-133	1	12V55W
8GH 002 090-251	1	24V70W
8KB 990 299-001	1	2000 mm long connecting lead for AMP plug connector with cap
8JD 008 151-011	10	Socket for AMP plug connector
8KW 701 235-033	100	Blade receptacles, 6.3 mm
9GH 993 984-001	1	Cap for AMP plug connector

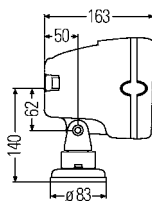
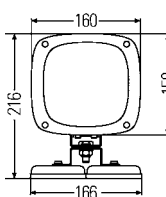
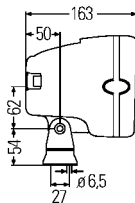
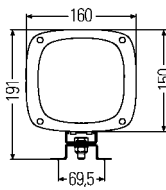
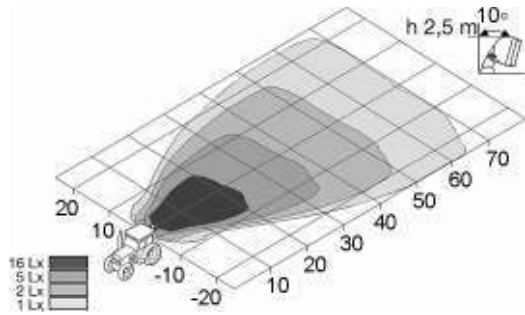

External-fitting work lights

AS 200 Xenon

Lens pattern for wide close-range illumination.
With gas discharge bulb. Light aperture: 123 x 123 mm.
 Recommended angle of inclination: 10° - 25°.
 Lens with plastic reflector bonded.
 Black plastic body with extending edge to protect lens.
 With red decorative ring. Handle recessed into body.
 Xenon electronic unit 42W integrated into body.
 Pivot base with bracket for four-point mounting.
 Type of protection: IP5K4K and IPX9K.

Part no.	Pk.	
1GA 996 142-001	1	Xenon-work light with 12V ballast unit, AMP plug connector and 3100 mm long connecting lead with relay and fuse
1GA 996 142-011	1	with 24V ballast unit, AMP plug connector and 3100 mm long connecting lead with relay and fuse
1GA 996 142-021	1	with 12V ballast unit, DEUTSCH plug connector and 3100 mm long connecting lead with relay and fuse
1GA 996 142-311	1	with 24V ballast unit, DEUTSCH plug connector and black decorative ring, without connecting lead
		Spare parts/Accessories:
1GA 990 305-001	1	Light unit
8GS 007 949-101	1	D2S gas discharge bulb, 35W
9GH 993 984-001	20	Cap for AMP plug connector
8KB 990 299-121	1	15A fuse and AMP plug connector, 24V
8KB 990 299-221	1	3700 mm long connecting lead with relay and fuse for DEUTSCH plug connector,
8KB 990 299-231	1	12V
8JS 711 687-821	1	24V
8JD 008 151-011	10	Blade-type fuses, 15A (5 pcs.)
8KW 701 235-033	100	Socket for AMP plug connector
8HG 990 320-001	1	Blade receptacles, 6.3 mm
8HG 990 263-111	1	Bracket attachment foot
		Mounting bracket for tubular mount on 15 mm - 28 mm dia. pipes
1GA 996 142-141	1	Xenon-work light with 24V ballast unit, PG-screw connection and 3000 mm long connection lead, without relay and fuse. Sealed version
1GA 996 142-241	1	with 230V ballast unit, PG-screw connection and 10.000 mm rubber lead with ground contact. Suitable in connection with current generator 230V-VSG 40W
		Spare parts/Accessories:
1GA 990 305-001	1	Light unit
8GS 007 949-101	1	D2S gas discharge bulb, 35W
1GA 996 142-041	1	with 12V ballast unit, magnet holder, PG-screw connection and 2500 mm long connection lead with plug 8JA 001 915-001. (Suitable sockets in compliance with DIN 4165)
		Spare parts/Accessories:
1GA 990 305-001	1	Light unit
8GS 007 949-101	1	D2S gas discharge bulb, 35W
8HG 004 806-001	1	Magnet holder with fixing material
9XD 130 261-001	5	Mounting bracket for magnet holder
8JS 711 687-821	1	Blade-type fuses, 15A (5 pcs.)
8JA 001 915-001	10	Plug, 2-pole

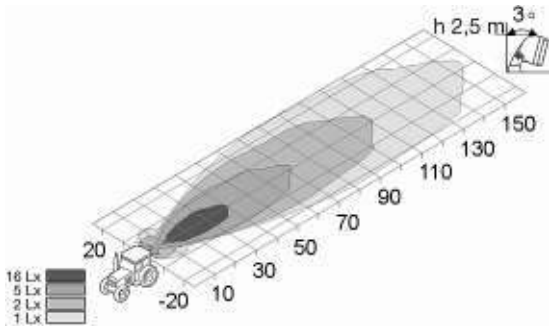

External-fitting work lights

AS 200 Xenon

Lens pattern for long-range illumination.
With gas discharge bulb, 24V ballast unit and 200 mm connecting lead. Light aperture: 123 x 123 mm.
 Recommended angle of inclination: 3° - 10°.
 Lens with plastic reflector bonded.
 Black plastic body with extending edge to protect lens.
 With red decorative ring. Handle recessed into body.
 Xenon electronic unit 42W integrated into body.
 Pivot base with bracket.
 Type of protection: IP5K4K and IPX9K.

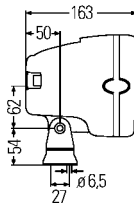
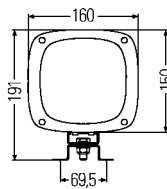

Part no.	Pk.	
1GA 996 142-061	1	Xenon-work light with 12V ballast unit, AMP plug connector and 3100 mm long connecting lead with relay and fuse
1GA 996 142-071	1	with 24V ballast unit, AMP plug connector and 3100 mm long connecting lead with relay and fuse
1GA 996 142-081	1	with 12V ballast unit, AMP plug connector, switch with integrated fuse and 2500 mm long connecting lead
1GA 996 142-091	1	with 24V ballast unit, AMP plug connector, switch with integrated fuse and 2500 mm long connecting lead
1GA 996 142-131	1	with 24V ballast unit, AMP plug connector and black decorative ring, without connecting lead
Spare parts/Accessories:		
1GA 990 305-011	1	Light unit
8GS 007 949-101	1	D2S gas discharge bulb, 35W
9GH 993 984-001	1	Cap for AMP plug connector
8KB 990 299-121	1	3100 mm long connecting lead with relay and fuse for AMP plug connector, 24V (for -071)
8JS 711 687-821	1	Blade-type fuses, 15A (5 pcs.)
8JD 008 151-011	10	Socket for AMP plug connector
8KW 701 235-033	100	Blade receptacles, 6.3 mm
8HG 990 320-001	1	Bracket attachment foot
8HG 990 263-111	1	Mounting bracket for tubular mount on 15 mm - 28 mm dia. pipes
1GA 996 142-151	1	with 24V ballast unit, PG-screw connection and 3000 mm long connecting lead, without relay and fuse. Sealed version
1GA 996 142-251	1	with 230V ballast unit, PG-screw connection and 10.000 mm rubber lead with ground contact. Suitable in connection with current generator 230V-VSG 40W
Spare parts:		
8GS 007 949-101	1	D2S gas discharge bulb, 35W

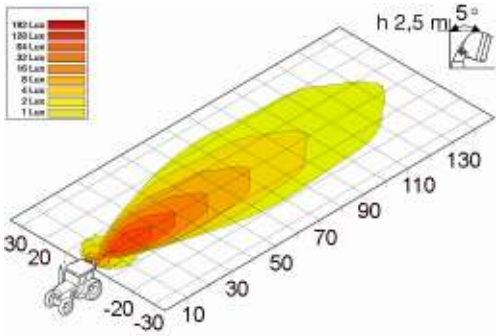

External-fitting work lights

AS 300 Xenon

Lens pattern for long-range illumination.
With gas discharge bulb, 24V ballast unit and 200 mm connecting lead. Light aperture: 123 x 123 mm.

Recommended angle of inclination: 3° - 10°.

Lens with plastic reflector bonded.

Black plastic body with extending edge to protect lens. With red decorative ring.

Handle recessed into body.

Xenon electronic unit 42W integrated into body.

Pivot base with bracket for four-point mounting with M10 fixing screws.

With vibration damping.

Type of protection: IP5K4K and IPX9K.

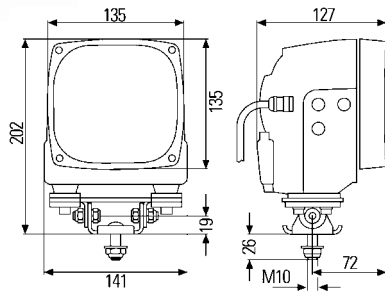

Part no.	Pk.	
1GA 996 242-541	1	Xenon-work light with DEUTSCH plug connector, 2-pole
Spare parts/Accessories:		
8GS 009 028-021	1	D1S gas discharge bulb, 35W
		3700 mm long connecting lead with relay and fuse for DEUTSCH plug connector,
8KB 990 299-231	1	24V
8JA 990 295-127	1	DEUTSCH plug, 2-pole
8JS 711 687-821	1	Blade-type fuses, 15A (5 pcs.)

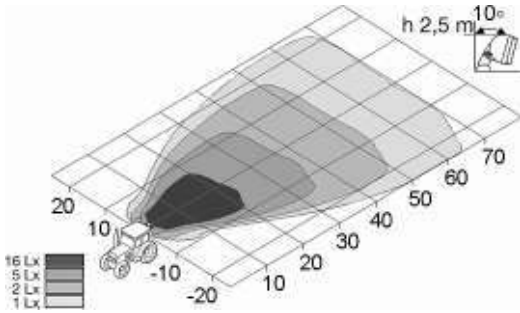

External-fitting work lights

AS 400 Xenon

Lens pattern for ground illumination.

With gas discharge bulb, 24V ballast unit and 200 mm connecting lead. Light aperture: 123 x 123 mm.

Recommended angle of inclination: 10° - 25°.

Lens with plastic reflector bonded.

Black body and red lens-retaining rim made of diecast aluminium.

Handle recessed into body.

Xenon electronic unit 42W integrated into body.

Pivot base made of stainless steel.

Type of protection: IP5K9K.

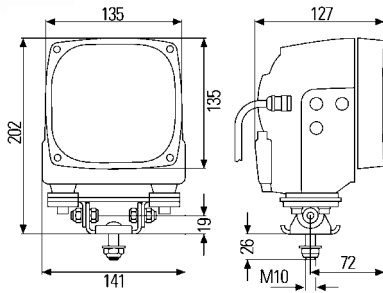

Part no.	Pk.	
1GA 996 242-111	1	Xenon-work light with vibration damping, pivot base with M10 fixing screw and DEUTSCH plug connector, 2-pole
1GA 996 242-521	1	without vibration damping, pivot base with M12 fixing screw, with AMP plug connector, 2-pole
Spare parts/Accessories:		
1GA 990 305-001	1	Light unit
8GS 009 028-021	1	D1S gas discharge bulb, 35W
8KB 990 299-231	1	3700 mm connecting lead with relay and fuse for DEUTSCH plug connector, 24V
8KB 990 299-121	1	3700 mm connecting lead with relay and fuse for AMP plug connector, 24V
8JA 990 295-127	1	DEUTSCH plug, 2-pole
8JS 711 687-821	1	Blade-type fuses, 15A (5 pcs.)

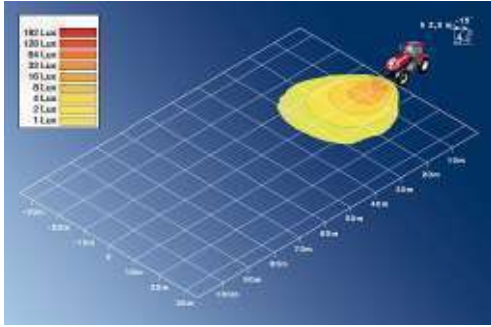

Built-in work lights

Ultra Beam Standard with FF® reflector

Lens pattern for wide ground illumination.

Light aperture: 83 x 83 mm.

Recommended angle of inclination: 15° - 20°.

Double reflector made of diecast aluminium, glued to hardened glass lens.

Black plastic body with extending edge to protect lens.

With four 3.9 x 60 mm fixing screws. Distance between screws: 66 x 95 mm.

Mounting area: 85 x 85 mm.

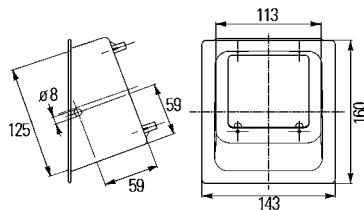
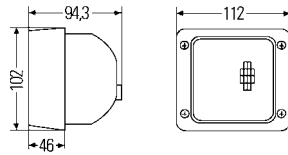

Part no.	Pk.	
1GA 007 506-121	1	Type of protection: IP5K4K FF®-H3 work light with grommet
1GA 007 506-111	1	Type of protection: IP6K4K and IPX9K FF®-H3 work light with AMP plug connector and protection cap
1GA 007 506-061	1	FF®-H3 work light with AMP plug connector and 12V55W bulb, without protection cap and fixing screws
1GA 007 506-431	1	FF®-H3 work light with AMP plug connector and 24V70W bulb, without protection cap
Spare parts/Accessories:		
1GA 998 525-001	1	Light unit
8GH 002 090-271	1	H3 bulb,
8GH 002 090-133	1	12V35W
8GH 002 090-251	1	12V55W
9GH 993 984-001	1	24V70W
9GT 990 338-001	20	Cap for AMP plug connector
8KB 990 299-001	1	Grommet for -121
8JD 008 151-011	10	2000 mm long connecting lead for AMP plug connector with cap
8KW 701 235-033	100	Socket for AMP plug connector
		Blade receptacles, 6.3 mm
9BG 990 353-001	1	(Supplied without work light) Mounting hollow, inclination 20°

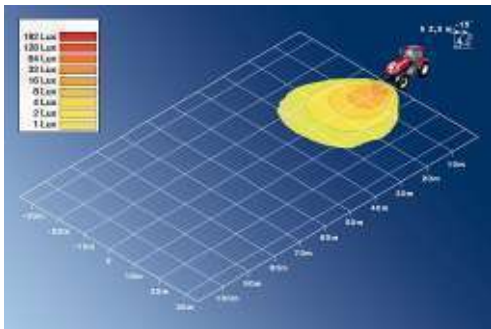

Work lights for upright or pendant mounting

Ultra Beam Standard with FF® reflector

Lens pattern for wide ground illumination.
Light aperture: 83 x 83 mm.

Recommended angle of inclination: 15° - 20°.
Reflector made of diecast aluminium, glued to hardened glass lens.
Black plastic body with extending edge to protect lens.
Pivot base with M10 fixing screw.
Without vibration damping. Pivot range vertical 130°.

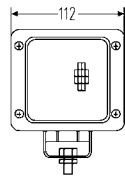
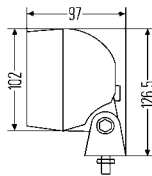

Part no.	Pk.	
1GA 007 506-081	1	Type of protection: IP5K4K FF®-H3 work light with grommet
1GA 007 506-001 1GA 007 506-007	1 30	Type of protection: IP6K4K and IPX9K FF®-H3 work light with AMP plug connector and protection cap
1GA 007 506-002	1	FF®-H3 work light with AMP plug connector and cap Self-service box
1GA 007 506-391	1	FF®-H3 work light with DEUTSCH plug connector and cap
1GA 997 506-371 1GA 997 506-377	1 18	FF®-H3 work light with magnet holder, vibration damping, PG-screw connection, 3500 mm long connecting lead with 2-pole plug and 12V35W bulb
1GA 998 525-001	1	Spare parts/Accessories: Light unit
8GH 002 090-271	1	H3 bulb,
8GH 002 090-133	1	12V35W
8GH 002 090-251	1	12V55W
9GH 993 984-001	1	24V70W
8HG 004 806-001	1	Cap for AMP plug connector
8JA 001 915-001	1	Magnet bracket
8JD 008 151-011	1	Plug, 2-pole
8KW 701 235-033	100	Socket for AMP plug connector
8HG 990 263-111	1	Blade receptacles, 6.3 mm
8KB 990 299-001	1	Mounting bracket for tubular mount on 15 mm - 28 mm dia. pipes
8KB 990 299-011	1	2000 mm long connecting lead for AMP plug connector with cap
	1	2000 mm long connecting lead for DEUTSCH plug connector with protection cap

Work lights for upright or pendant mounting

Ultra Beam Standard with FF® reflector

Lens pattern for long-range illumination.
Light aperture: 83 x 83 mm.

Recommended angle of inclination: 15° - 20°.
Reflector made of diecast aluminium, glued to hardened glass lens.
Black plastic body with extending edge to protect lens.
Pivot base with M10 fixing screw,
for upright or pendant mounting.
Without vibration damping. Pivot range vertical 130°.

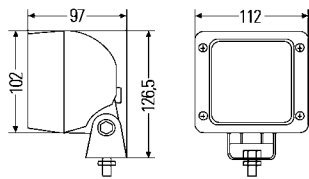
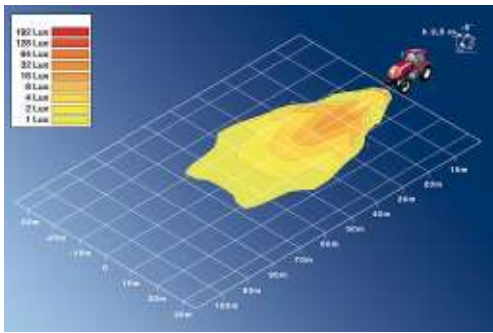

Part no.	Pk.	
1GA 997 506-021	1	Type of protection: IP6K4K and IPX9K FF®-H3 work light with AMP plug connector and protection cap
		Spare parts/Accessories:
		H3 bulb,
8GH 002 090-271	1	12V35W
8GH 002 090-133	1	12V55W
8GH 002 090-251	1	24V70W
8JD 008 151-011	10	Socket for AMP plug connector
8KW 701 235-033	100	Blade receptacles, 6.3 mm
8HG 990 263-111	1	Mounting bracket for tubular mount on 15 mm - 28 mm dia. pipes
8KB 990 299-001	1	2000 mm long connecting lead for AMP plug connector with cap

Ultra Beam Heavy Duty with FF® reflector

Lens pattern for wide close-range illumination.
Light aperture: 83 x 83 mm.

Recommended angle of inclination: 15° - 20°.
Reflector made of diecast aluminium, glued to hardened glass lens.
Black plastic body with extending edge to protect lens.
Vibration damped pivot base with bracket
for four-point mounting.
Pivot range vertical 130°.

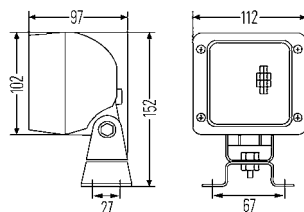
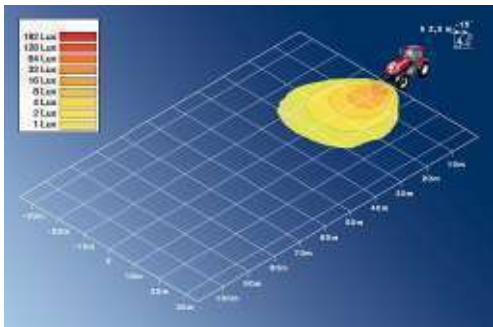

Part no.	Pk.	
1GA 007 506-011	1	Type of protection: IP6K4K and IPX9K FF®-H3 work light with AMP plug connector and rubber cap
1GA 007 506-012	1	FF®-H3 work light with AMP plug connector and rubber cap, self-service box
1GA 997 506-601	1	FF®-H3 work light with lens pattern-free AMP plug connector and sealing cap
1GA 007 506-091	1	Type of protection: IP5K4K FF®-H3 work light with grommet
		Spare parts/Accessories:
1GA 998 525-001	1	Light unit (except -601)
		H3 bulb,
8GH 002 090-271	1	12V35W
8GH 002 090-133	1	12V55W
8GH 002 090-251	1	24V70W
9GH 993 984-001	1	Cap for AMP plug connector
8JD 008 151-011	10	Socket for AMP plug connector
8KW 701 235-033	100	Blade receptacles, 6.3 mm
8HG 990 263-111	1	Mounting bracket for tubular mount on 15 mm - 28 mm dia. pipes
8KB 990 299-001	1	2000 mm long connecting lead for AMP plug connector with cap

Accessories see page 4.123 - 4.125

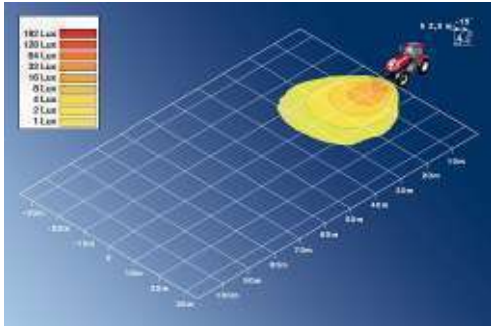

Work lights for upright or pendant mounting

Ultra Beam Heavy Duty with FF® reflector

Lens pattern for wide close-range illumination.

Light aperture: 83 x 83 mm.

Recommended angle of inclination: 15° - 20°.

Reflector made of diecast aluminium, glued to hardened glass lens.

Black plastic body with extending edge to protect lens.

Pivot base with vibration damping and M10 fixing screw.

Pivot range vertical 130°.

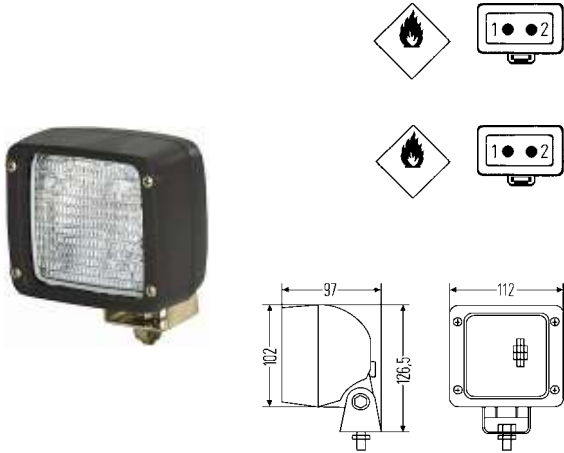

Part no.	Pk.	
1GA 007 506-651	1	FF®-H3 work light with 12V55W bulb and DEUTSCH plug connector
1GA 007 506-491	1	FF®-H3 work light without bulb, with DEUTSCH plug connector
1GA 007 506-451	1	FF®-H3 work light without bulb, with PG-lead retention
1GA 998 525-001	1	Spare parts/Accessories: Light unit
8GH 002 090-271	1	H3 bulb,
8GH 002 090-133	1	12V35W
8GH 002 090-251	1	12V55W
9GH 993 984-001	1	24V70W
8JD 008 151-011	1	Cap for AMP plug connector
8KW 701 235-033	10	Socket for AMP plug connector
8HG 990 263-111	100	Blade receptacles, 6.3 mm
8KB 990 299-011	1	Mounting bracket for tubular mount on 15 mm - 28 mm dia. pipes
	1	2000 mm long connecting lead for DEUTSCH plug connector with protection cap

Work lights for upright or pendant mounting

Ultra Beam Heavy Duty with FF® reflector

Lens pattern for wide ground illumination.
Light aperture: 83 x 83 mm.

Recommended angle of inclination: 15° - 20°.
Reflector made of diecast aluminium, glued to hardened glass lens.
Black plastic body with extending edge to protect lens. With handle.
Pivot base with vibration damping and bracket for four-point mounting.
Pivot range vertical 130°.

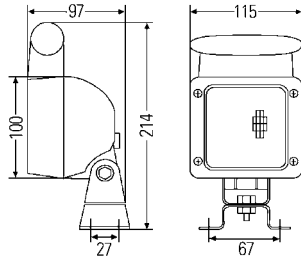
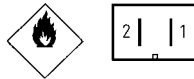
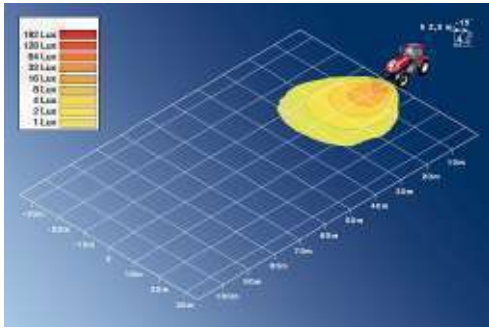

Part no.	Pk.	
1GA 007 506-021	1	Type of protection: IP6K4K and IPX9K FF®-H3 work light with AMP plug connector and protection cap
1GA 997 506-631	1	FF®-H3 work light with lens pattern-free and switch, AMP plug connector and sealing cap
1GA 007 506-101	1	Type of protection: IP5K4K FF®-H3 work light with grommet
1GA 998 525-001	1	Spare parts/Accessories: Light unit
8GH 002 090-271	1	H3 bulb,
8GH 002 090-133	1	12V35W
8GH 002 090-251	1	12V55W
9GH 993 984-001	1	24V70W
9XD 990 298-001	1	Cap for AMP plug connector
8JD 008 151-011	10	Bracket for four-point fixing
8KW 701 235-033	100	Socket for AMP plug connector
8HG 990 263-111	1	Blade receptacles, 6.3 mm
8KB 990 299-001	1	Mounting bracket for tubular mount on 15 mm - 28 mm dia. pipes 2000 mm long connecting lead for AMP plug connector with cap

External-fitting work lights

Ultra Beam Heavy Duty with FF® reflector

Lens pattern for wide close-range illumination.
With 24V70W bulb. Light aperture: 83 x 83 mm.

Recommended angle of inclination: 15° - 20°.
Reflector made of diecast aluminium, glued to hardened glass lens.
Black plastic body with extending edge to protect lens. With handle.
With magnet base, lead retention, and spirally coiled lead,
stretched length of lead 3500 mm,
Pivot range vertical 130°.

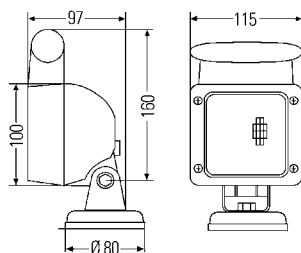
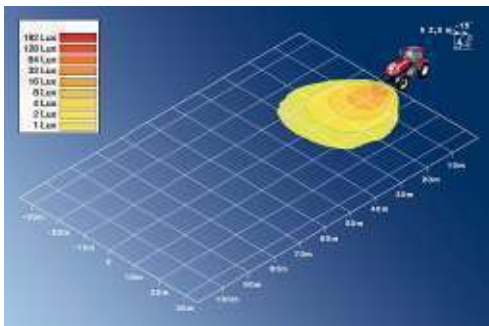

Part no.	Pk.	
1GA 997 506-157	1	FF®-H3 work light with 3-pole plug
1GA 997 506-557	1	with 2-pole plug
1GA 998 525-001	1	Spare parts/Accessories: Light unit
8GH 002 090-271	1	H3 bulb,
8GH 002 090-133	1	12V35W
8GH 002 090-251	1	12V55W
8JA 002 263-031	1	24V70W
8JA 001 915-001	1	Plug,
8JB 001 933-031	1	3-pole Plug-set, 2-poles Socket, 3-pole for -157

Accessories see page 4.123 - 4.125

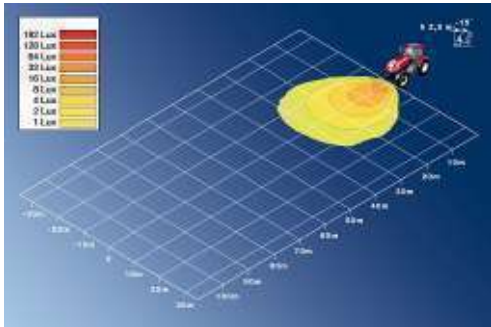

External-fitting work lights

Ultra Beam Standard with FF® reflector

Lens pattern for wide ground illumination.

Light aperture: 83 x 83 mm.

Recommended angle of inclination: 15° - 20°.

Reflector made of diecast aluminium, glued to hardened glass lens.

Black plastic body with extending edge to protect lens.

With side rotary pivot base.

With M10 fixing screw for mounting on vertical surfaces.

Pivot range: horizontal 130°, inclination range: vertical 90°.

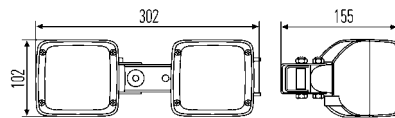
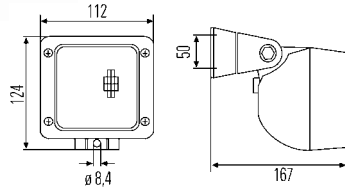

Part no.	Pk.	
1GA 996 083-011	1	Type of protection: IP5K4K FF®-H3 work light with grommet
1GA 996 083-001	1	Type of protection: IP6K4K and IPX9K FF®-H3 work light with AMP plug connector and protection cap
		Spare parts/Accessories:
1GA 998 525-001	1	Light unit
8GH 002 090-271	1	H3 bulb,
8GH 002 090-133	1	12V35W
8GH 002 090-251	1	12V55W
9GH 993 984-001	1	24V70W
8HG 990 263-001	1	Cap for AMP plug connector
9XD 990 298-001	5	Mounting bracket for tubular mount on 15 - 28 mm dia. pipes
8KB 990 299-001	1	Bracket for four-point mounting
8JD 008 151-011	10	2000 mm long connecting lead for AMP plug connector with cap
8KW 701 235-033	100	Socket for AMP plug connector
		Blade receptacles, 6.3 mm
1GA 996 083-021	1	Type of protection: IP5K4K FF®-H3 work light with swivelling bow for double equipment and grommet
		Spare parts/Accessories:
1GA 998 525-001	1	Light unit
8GH 002 090-271	1	H3 bulb,
8GH 002 090-133	1	12V35W
8GH 002 090-251	1	12V55W
		24V70W

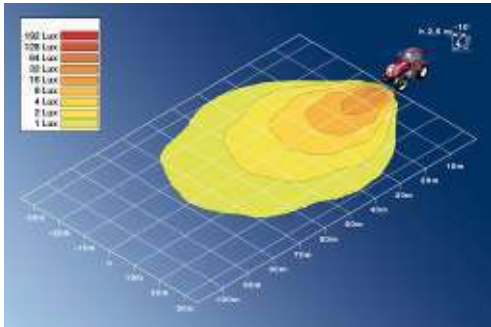

Work lights for upright or pendant mounting

Ultra-Beam Xenon

Lens pattern for extremely wide, intense and far-reaching illumination. With gas discharge bulb. Light aperture: 83 x 83 mm.

Reflector made of diecast aluminium, glued to hardened glass lens. Black plastic body and red lens-retaining rim.

Lens-retaining rim with extending edge to protect lens.

Pivot base with vibration damping.

Pivot range vertical 105°. Type of protection: IP5K4K.

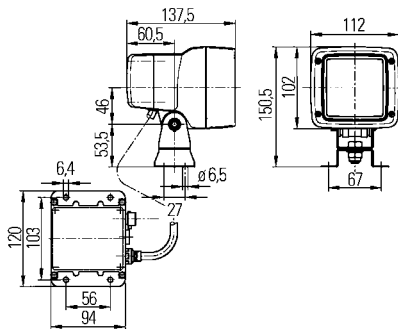

Part no.	Pk.	
1GA 998 534-001	1	Xenon work light with bracket for four-point mounting made of stainless steel and 3700 mm long connecting lead, relay and 15A fuse, with 12V ballast unit
1GA 998 534-011	1	with 24V ballast unit
1GA 998 534-061	1	Xenon work light without bracket, without lead, with 12V ballast unit
1GA 998 525-011	1	Spare parts/Accessories: Light unit
8GS 007 949-101	1	D2S gas discharge bulb, 35W
5DV 990 264-001	1	Ballast unit, 12V
5DV 990 264-011	1	24V
8KB 149 147-001	1	3700 mm long connecting lead from ballast unit to battery, with relay and fuse, 12V

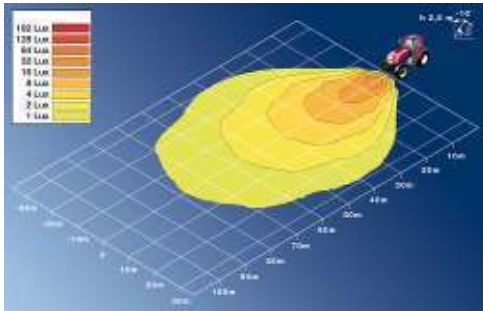

Built-in work lights

Ultra-Beam Xenon

Lens pattern for wide, intense and far-reaching illumination. With DEUTSCH plug connector and gas discharge bulb. Light aperture: 83 x 83 mm.

Reflector made of diecast aluminium, glued to hardened glass lens. Black body and red lens-retaining rim made of plastic. Work light permanently connected by 3000 mm long lead with ballast unit 42W. The lead can be disconnected from the ballast unit by means of a plug-connection.

Without connecting lead.
Type of protection: IP5K4K.

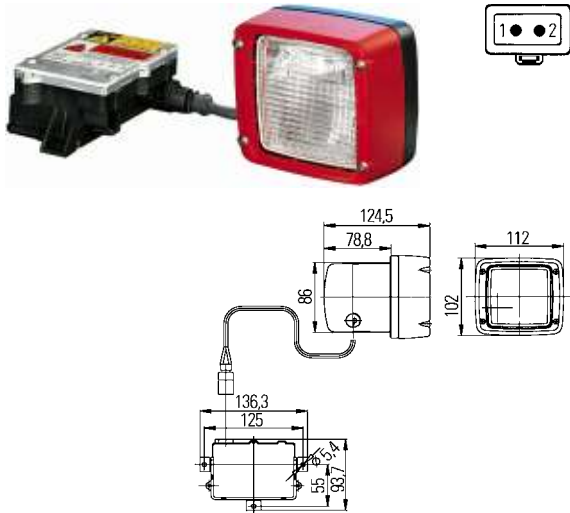

Part no.	Pk.	
1GA 998 534-541	1	Xenon-work light with 24V ballast unit
Spare parts/Accessories:		
1GA 998 525-071	1	Light unit
8GS 009 028-021	1	D1S gas discharge bulb, 35W Ballast unit,
5DV 008 856-001	1	24V
5DV 008 856-007	24	Connector lead between work light and ballast unit,
8KB 990 299-241	1	1000 mm
8KB 990 299-251	1	3000 mm
8KB 990 299-221	1	3700 mm long connecting lead with relay and fuse for DEUTSCH plug connector,
8KB 990 299-231	1	12V
	1	24V

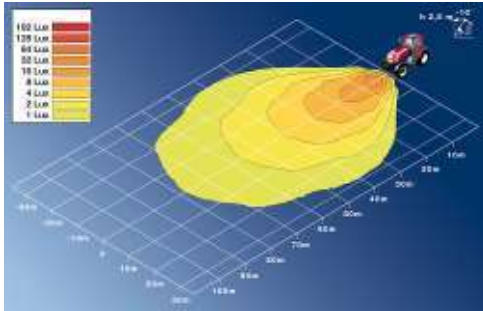

External fitting work lights for upright mounting

Ultra-Beam Xenon

Lens pattern for wide, intense and far-reaching illumination. With DEUTSCH plug connector and gas discharge bulb. Light aperture: 83 x 83 mm.

Reflector made of diecast aluminium, glued to hardened glass lens. Black body and red lens-retaining rim made of plastic. Pivot base with vibration damping and bracket for four-point mounting made of stainless steel. Pivot range vertical 105 °.

Work light permanently connected by lead with ballast unit 42W. The lead can be disconnected from the ballast unit by means of a plug-connection.

Without connecting lead. Type of protection: IP5K4K.

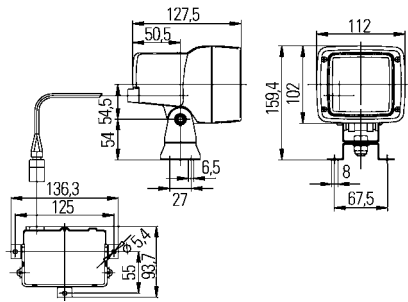

Part no.	Pk.	
1GA 998 534-221	1	Xenon work light with 3000 mm long connector lead and 12V ballast unit
1GA 998 534-231	1	and 24V ballast unit
1GA 998 534-271	1	Xenon work light with 500 mm long connector lead and 24V ballast unit
Spare parts/Accessories:		
1GA 998 525-071	1	Light unit
8GS 009 028-021	1	D1S gas discharge bulb, 35W
		Ballast unit,
5DV 008 855-001	1	12V
5DV 008 855-007	24	
5DV 008 856-001	1	24V
5DV 008 856-007	24	
		Connection lead between work light and ballast unit,
8KB 990 299-241	1	1000 mm
8KB 990 299-251	1	3000 mm
		3700 mm long connecting lead with relay and fuse for DEUTSCH plug connector,
8KB 990 299-221	1	12V
8KB 990 299-231	1	24V

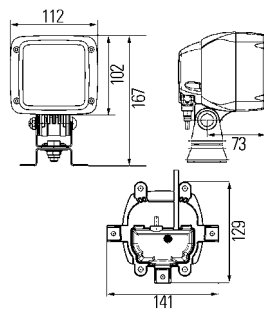
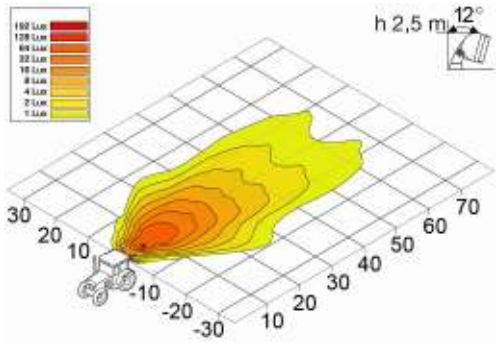

External-fitting work lights

Ultra-Beam Xenon

Lens pattern for close-range illumination.

With gas discharge bulb. Light aperture: 83 x 83 mm.

Recommended angle of inclination: 3° - 10°.

Reflector made of diecast aluminium, glued to hardened glass lens.

Black plastic body and red lens-retaining rim with red extending edge to protect lens.

Rear of housing made of black diecast aluminium with 100 mm lead and 2-pole AMP plug connector.

Work light permanently connected to ballast unit by a 500 mm long lead.

Vibration-damped pivot base with bracket for four-point mounting.

Type of protection: IP5K9K. System capacity: 50W.

Part no.	Pk.	
1GA 998 534-671	1	Xenon work light with 500 mm lead and 2-pole AMP plug for upright mounting, with 12V ballast unit
1GA 998 534-681	1	with 24V ballast unit
8GS 009 028-021	1	Spare parts: D1S gas discharge bulb, 35W

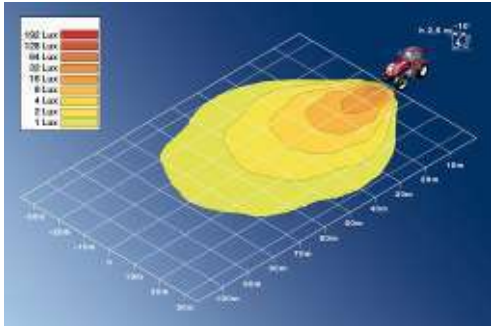

External-fitting work lights

Ultra Beam Xenon-Powerpack

Lens pattern for close-range illumination.
With gas discharge bulb, 500 mm long lead and 2-pole AMP plug.
Light aperture: 83 x 83 mm.
 Recommended angle of inclination: 3° - 10°.
 Reflector made of diecast aluminium, glued to hardened glass lens.
 Black plastic body and red lens-retaining rim made of plastic, with extending edge to protect lens.
 Rear of housing made of black diecast aluminium.
 Xenon electronic unit integrated into housing.
 Vibration-damped pivot base with bracket for four-point mounting.
 Additionally enclosed, displaceable bracket for single-point attachment.
 Type of protection: IP5K4K. System capacity: 42W.

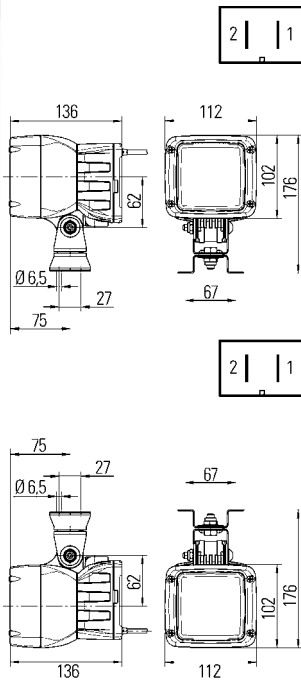

Part no.	Pk.	
1GA 998 534-431	1	Xenon work light for upright mounting, with 12V ballast unit
1GA 998 534-451	1	with 24V ballast unit
1GA 998 534-441	1	Xenon work light for pendant mounting, with 12V ballast unit
1GA 998 534-461	1	with 24V ballast unit
8GS 009 028-021	1	Spare parts: D1S gas discharge bulb, 35W

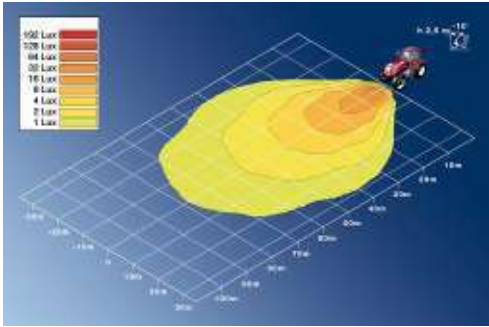

External fitting work lights for upright mounting

Ultra Beam Xenon-Pack

With gas discharge bulb, 300 mm long lead and DEUTSCH plug connector.
Light aperture: 83 x 83 mm.

Recommended angle of inclination: 3° - 10°.
 Reflector made of diecast aluminium, glued to hardened glass lens.
 Black plastic body with red extending edge to protect lens.
 Rear of body made of black die-cast aluminium.
 Xenon electronic unit 42W integrated into body.
 Vibration-damped pivot base with bracket for four-point mounting.
 Additionally enclosed, displaceable bracket for single-point attachment.
 Type of protection: IP5K4K.

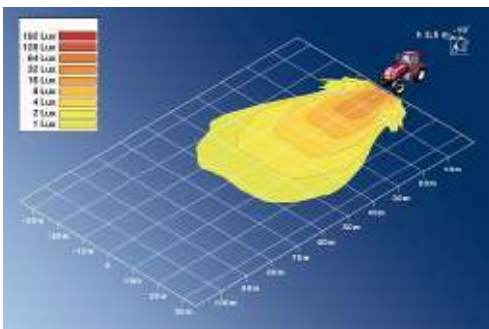
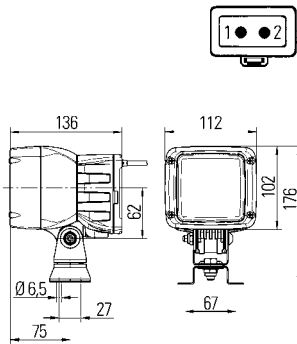

Part no.	Pk.	Description
1GA 998 534-491	1	Xenon work light with 24V ballast unit, with red lens-retaining rim and lens pattern for close-range illumination
1GA 998 534-601	1	with black lens-retaining rim and lens pattern for close-range illumination
1GA 998 534-691	1	with black lens-retaining rim and lens pattern for off-road illumination
8GS 009 028-021	1	Spare parts: D1S gas discharge bulb, 35W

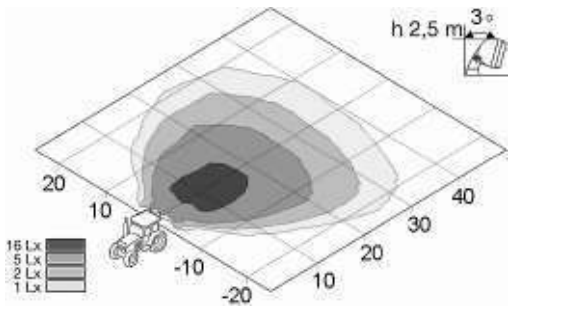

External fitting work lights for upright mounting

Ultra Beam H9 with FF® reflector

Lens pattern for wide close-range illumination.

With 12V bulb. Light aperture: 83 x 83 mm.

Recommended angle of inclination: 3° - 10°.

Reflector made of diecast aluminium, glued to hardened glass lens.

Black plastic body with extending edge to protect lens.

Pivot base with bracket for four-point mounting, without vibration damping.

Type of protection: IP5K4K and IPX9K.

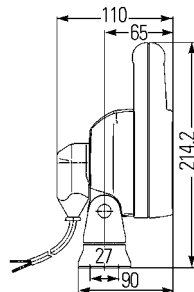
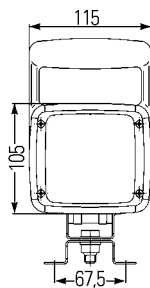
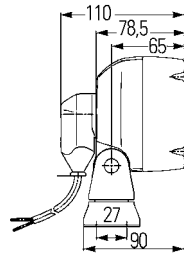
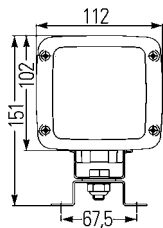
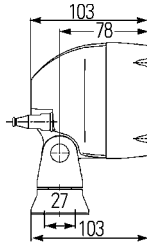
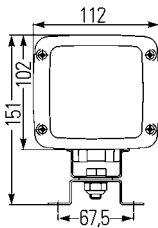

Part no.	Pk.	
1GA 996 150-081	1	FF®-H9 work light with AMP plug connector and protection cap
Spare parts/Accessories:		
1GA 998 525-041	1	Light unit
8GH 008 357-001	1	H9 bulb, 12V65W
9GH 993 984-001	1	Cap for AMP plug connector
8KB 990 299-001	1	2000 mm long connecting lead for AMP plug connector with cap
1GA 996 150-021	1	with 2000 mm long connecting lead and rotation cap to cover the bulb. 12V bulb accessible from the outside
Spare parts/Accessories:		
1GA 998 525-041	1	Light unit
8GH 008 357-001	1	H9 bulb, 12V65W
8JD 158 175-807	1	H9 socket set (20 pcs.)
1GA 996 150-071	1	with handle, with 2000 mm long connecting lead and rotation cap to cover the bulb. 12V bulb accessible from the outside
Spare parts/Accessories:		
1GA 998 525-041	1	Light unit
8GH 008 357-001	1	H9 bulb, 12V65W
8HG 990 263-111	1	Mounting bracket for tubular mount on 15 mm - 28 mm dia. pipes

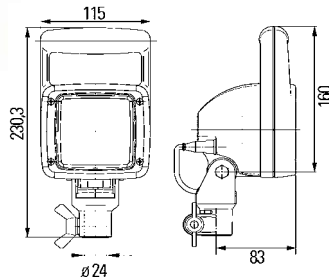
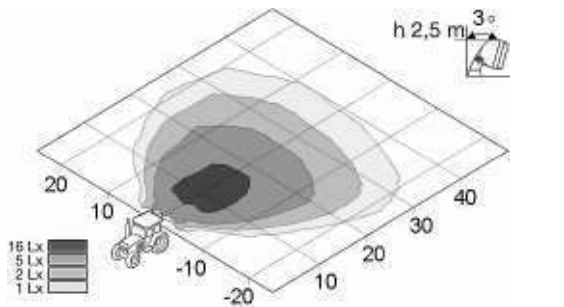

External fitting work lights for upright mounting

Ultra Beam H9 with FF® reflector

Lens pattern for wide close-range illumination.

Light aperture: 83 x 83 mm.

Recommended angle of inclination: 3° - 10°.

Reflector made of diecast aluminium, glued to hardened glass lens.

Black plastic body and lens-retaining rim with extending edge to protect lens.

With spigot mount 24 mm dia. with integrated electrical contacts (DIN 72591).

Type of protection: IP5K4K and IPX9K.

Part no.	Pk.	
1GA 996 150-151	1	FF®-H9 work light with AMP plug connector and protection cap, with handle and 12V bulb
Spare parts/Accessories:		
1GA 998 525-041	1	Light unit
8GH 008 357-001	1	H9 bulb, 12V65W
8HG 990 320-001	1	Bracket attachment foot
8HG 006 294-021	1	Push-on pipe, 24 mm dia.

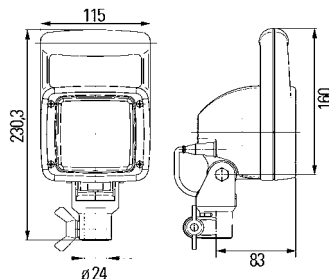
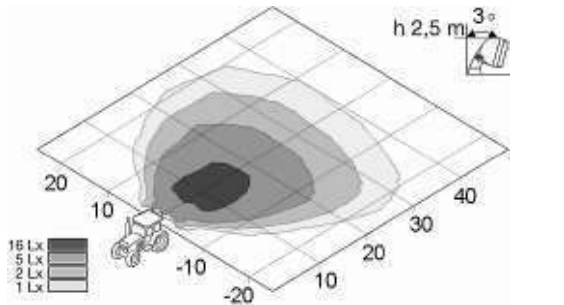

Ultra Beam Heavy Duty with FF® reflector

Lens pattern for wide close-range illumination.

Light aperture: 83 x 83 mm.

Recommended angle of inclination: 15° - 20°.

Reflector made of diecast aluminium, glued to hardened glass lens.

Black plastic body and lens-retaining rim with extending edge to protect lens.

With spigot mount 24 mm dia. with integrated electrical contacts (DIN 72591).

Type of protection: IP5K4K and IPX9K.

Part no.	Pk.	
1GA 007 506-681	1	FF®-H3 work light with handle and 24V bulb
Spare parts/Accessories:		
1GA 998 525-001	1	Light unit
8GH 002 090-271	1	H3 bulb, 12V35W
8GH 002 090-133	1	12V55W
8GH 002 090-251	1	24V70W
8HG 990 320-001	1	Bracket attachment foot

Work lights for upright or pendant mounting

Power Beam 1000

Lens pattern for close-range illumination.
With 6 Power LEDs. Light aperture: 100 x 80 mm.
 6-part reflector made of plastic, glued to pattern-free lens.
 Black finish aluminium housing with cooling ribs.
 2-pole DEUTSCH plug connector integrated.
 Pivot base made of stainless steel with M10 fixing screw.
 Type of protection: IP6K7 and IP6K9K.



Part no.	Pk.	
1GA 996 188-001	1	LED work light, rear of housing made of blue plastic, without vibration dumping, with glass lens, 850 lm
1GA 996 188-021	1	rear of housing made of black plastic, without vibration dumping, with plastic lens, 850 lm
1GA 996 188-011	1	LED work light rear of body made of blue plastic. Heavy Duty bracket with M10 fixing screw, with vibration dumping and glass lens, 850 lm
8KB 990 299-011	1	Accessories: 2000 mm long connecting lead for DEUTSCH plug connector with protection cap

External-fitting work lights

Power Beam 2000

Lens pattern for close-range illumination.

With 16 Power LEDs. Light aperture: 83 x 83 mm.

16-part reflector made of plastic, glued to pattern-free lens.

Black finish aluminium housing with cooling ribs.

With 2000 mm long connecting lead with polarity reversal protection.

Pivot base made of stainless steel with M10 fixing screw.

Without vibration damping.

Voltage range: 12V - 24V, 43W.

Type of protection: IP6K7 and IP6K9K.

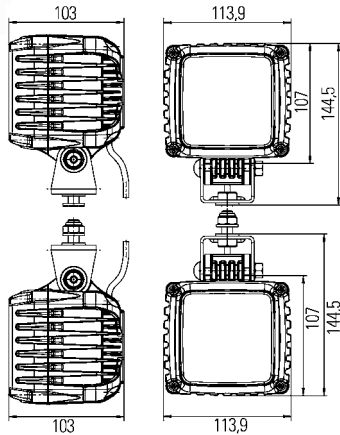

Part no.	Pk.	
1GA 996 189-001	1	LED work light, rear housing cover made of blue plastic, with pressed glass lens, 2000 lm, for upright mounting
1GA 996 189-031	1	rear housing cover made of blue plastic, with pressed glass lens, 2000 lm, for pendant mounting

External fitting work lights for upright mounting

Power Beam 3000

Lens pattern for close-range illumination.

With 16 Power LEDs. Light aperture: 83 x 83 mm.

16-part reflector made of plastic, glued to pattern-free lens.

Black finish aluminium housing with cooling ribs.

With 2000 mm long connecting lead with polarity reversal protection.

Pivot base made of stainless steel with M10 fixing screw.

Without vibration damping.

Voltage range: 12V - 24V, 43W.

Type of protection: IP6K7 and IP6K9K.

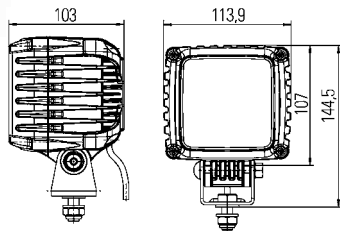

Part no.	Pk.	
1GA 996 192-001	1	LED work light, rear housing cover made of silver plastic, with pressed glass lens, 3000 lm

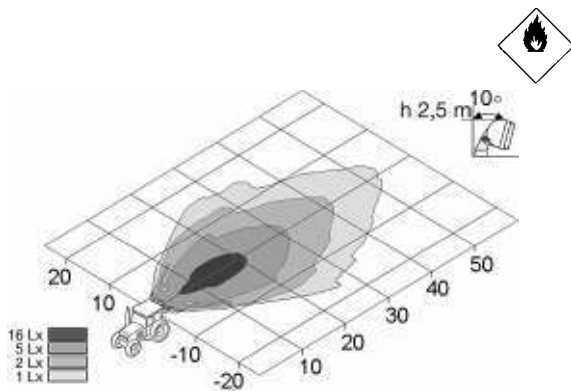
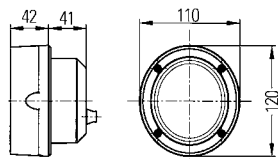
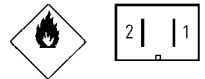
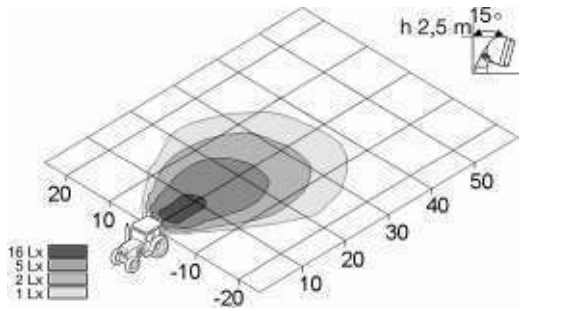

Built-in work lights

Mega Beam with FF® reflector

Light aperture: 83 x 92 mm.

Reflector made of diecast aluminium, glued to hardened glass lens.

Body and cover ring grey.

Black plastic lens-retaining rim with extending edge to protect lens.

With four 3.9 x 50 mm fixing screws. Distance between screws: 70 x 70 mm.

Mounting area: 83 x 93 mm. Type of protection: IP5K4K.

Part no.	Pk.	
		Lens pattern for wide close-range illumination. Recommended angle of inclination: 15° - 25°.
1GM 996 134-311	1	FF®-H3 work light with AMP plug connector and protection cap
		Spare parts/Accessories: H3 bulb, 8GH 002 090-271 1 12V35W 8GH 002 090-133 1 12V55W 8GH 002 090-251 1 24V70W 9GH 993 984-001 1 Cap for AMP plug connector
		Lens pattern for off-road illumination. Recommended angle of inclination: 10° - 15°.
1GM 996 134-091	1	FF®-H3 work light with grommet
		Spare parts/Accessories: H3 bulb, 8GH 002 090-271 1 12V35W 8GH 002 090-133 1 12V55W 8GH 002 090-251 1 24V70W

External-fitting work lights

Mega Beam LED

Lens pattern for close-range illumination.
With 4 LEDs. Light aperture: 83 x 92 mm.
 Recommended angle of inclination: 3° - 10°.
 4-part reflector glued to pattern-free glass lens.
 Black finish aluminium body with cooling ribs.
 Black lens-retaining rim. Blue plastic cover- and intermediate ring.
 Pivot base with M10 fixing screw. With 2000 mm long connection lead.
 Type of protection: IP5K9K.

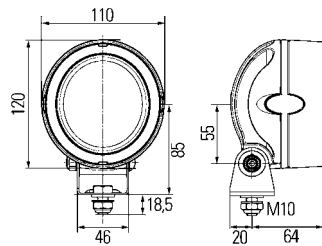

Part no.	Pk.	
1GM 996 136-101	1	LED work light, 180 lm Voltage range: 12V - 24V, 7W for upright mounting
1GM 996 136-111	1	for pendant mounting
1GM 996 136-131	1	LED work light, 180 lm Voltage range: 36V - 80V, 7W for upright mounting
1GM 996 136-191	1	LED work light, 600 lm Voltage range: 12V - 24V, 15W for upright mounting
1GM 996 136-192	1	for upright mounting, Self-service box
1GM 996 136-241	1	for pendant mounting

Built-in work lights

Mega Beam Xenon

Lens pattern for close-range illumination.
With gas discharge bulb. Light aperture: 83 x 92 mm.
 Recommended angle of inclination: 10° - 15°.
 Reflector made of diecast aluminium, glued to hardened glass lens.
 Red body and screw cover rim. Black lens-retaining rim.
 Without connecting lead.
 Work light permanently connected to ballast unit 42W by a 310 mm long lead.
 Type of protection: IP5K4K.

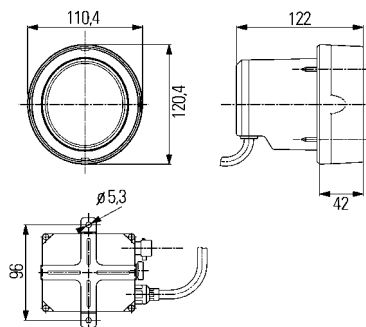
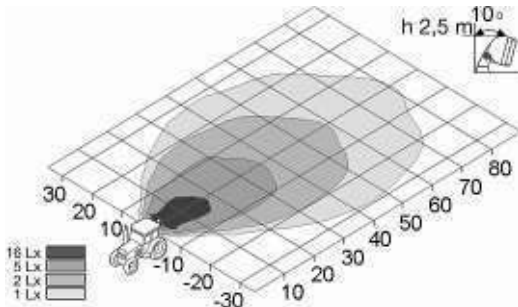

Part no.	Pk.	
1GM 996 135-551	1	Xenon work light with 24V ballast unit
8GS 007 949-101	1	Spare parts: D2S gas discharge bulb, 35W



External fitting work lights for upright mounting

Mega Beam Xenon

With gas discharge bulb. Light aperture: 83 x 92 mm.

Recommended angle of inclination: 10° - 15°.

Reflector made of diecast aluminium, glued to hardened glass lens. Black plastic body and lens-retaining rim, red plastic cover rim with extending edge to protect lens.

Pivot base with vibration damping and bracket for four-point mounting made of stainless steel.

Pivot range vertical 70°.

For upright mounting.

Work light permanently connected to ballast unit 42W by a 300 mm long lead.

With 3700 mm long connecting lead, relay and 15A fuse.

Type of protection: IP5K4K.

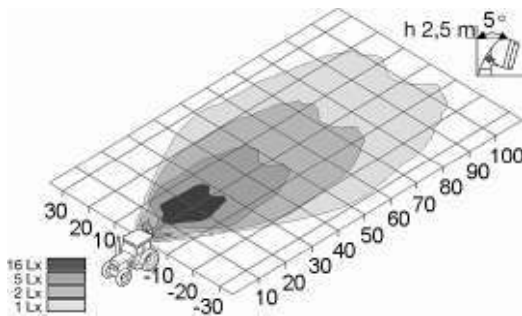
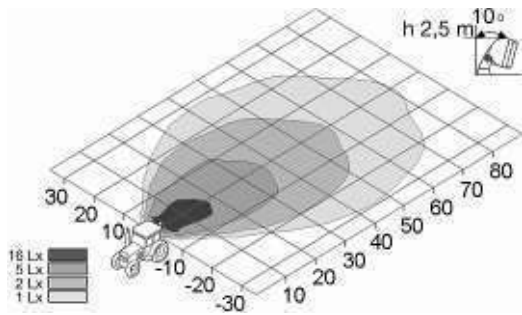
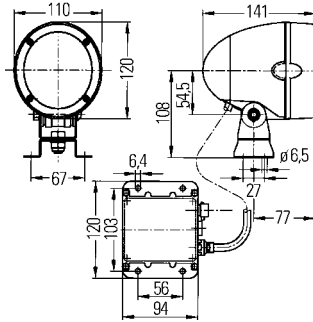

Part no.	Pk.	
1GM 996 135-001	1	Xenon work light with lens pattern for close-range illumination and 12V ballast unit
1GM 996 135-041	1	and 24V ballast unit
1GM 996 135-051	1	Xenon work light with lens pattern for long-range illumination and 24V ballast unit
8GS 007 949-101	1	Spare parts: D2S gas discharge bulb, 35W
5DV 990 264-001	1	Ballast unit, 12V
5DV 990 264-011	1	24V
8KB 149 147-001	1	3700 mm long connecting lead from ballast unit to battery, with relay and fuse, 12V

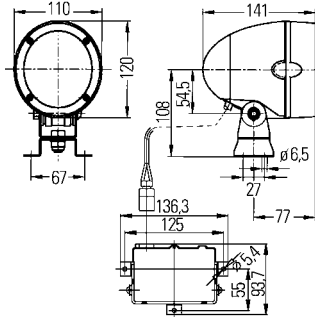

External fitting work lights for upright mounting

Mega-Beam Xenon



Light aperture: 83 x 92 mm. With gas discharge bulb and DEUTSCH plug connector, without ballast unit and connecting lead (see accessories)

Reflector made of diecast aluminium, glued to hardened glass lens. Black body and lens-retaining rim, red cover rim with extending edge to protect lens.

Pivot base with vibration damping and bracket for four-point mounting made of stainless steel.

Pivot range vertical 70°.

Work light permanently connected to ballast unit 42W by a 3000 mm long lead. The lead can be disconnected from the ballast unit by means of a plug-connection. Type of protection: IP5K4K.

Part no.	Pk.	
1GM 996 135-101	1	 Xenon work light with lens pattern for close-range illumination, recommended angle of inclination: 10° - 20°
1GM 996 135-111	1	 Xenon work light with lens pattern for long-range illumination, recommended angle of inclination: 5° - 10°
1GM 990 303-151	1	Spare parts/Accessories: Light unit for -101
8GS 009 028-021	1	D1S gas discharge bulb, 35W
8KB 990 299-251	1	3000 mm connecting lead between work light and ballast unit
5DV 008 855-001	1	Ballast (for D1S), with DEUTSCH plug connector, 12V
5DV 008 855-007	24	
5DV 008 856-001	1	24V
5DV 008 856-007	24	
8KB 990 299-221	1	3700 mm long connecting lead with relay and fuse for DEUTSCH plug connector, 12V
8KB 990 299-231	1	24V

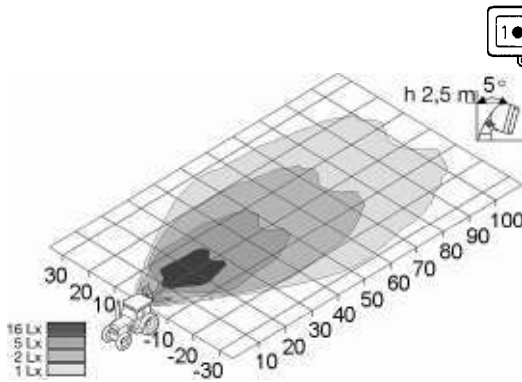
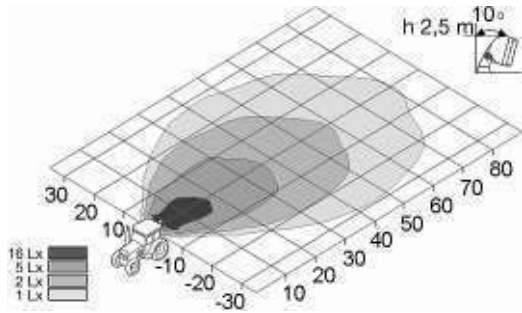

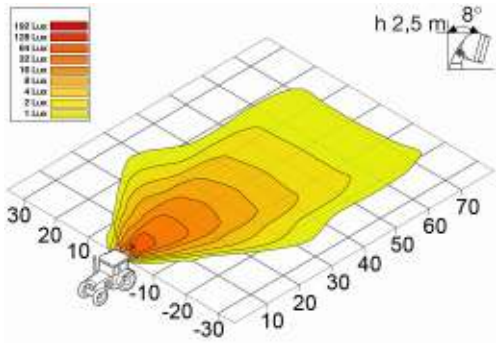

External-fitting work lights

Mega-Beam Xenon

Lens pattern for close-range illumination.

With gas discharge bulb. Light aperture: 83 x 92 mm.

Recommended angle of inclination: 3° - 10°.

Reflector made of diecast aluminium, glued to hardened glass lens.

Black plastic body and red lens-retaining rim with red extending edge to protect lens.

Rear of housing made of black diecast aluminium with 100 mm lead and 2-pole AMP plug connector.

Work light permanently connected to ballast unit by a 500 mm long lead.

Vibration-damped pivot base with bracket for four-point mounting.

Type of protection: IP5K9K. System capacity: 50W.

Part no.	Pk.	
1GM 996 135-361	1	Xenon work light for upright mounting, with 12V ballast unit
1GM 996 135-371	1	Xenon work light with 500 mm lead and 2-pole AMP plug for upright mounting, with 24V ballast unit
8GS 009 028-021	1	Spare parts: D1S gas discharge bulb, 35W

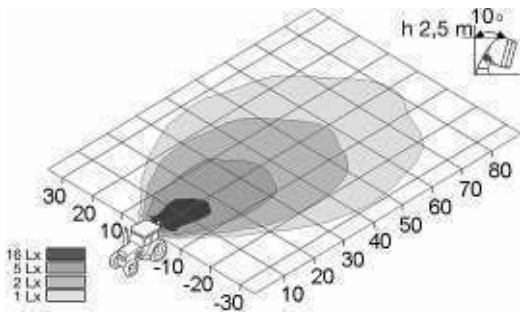

External-fitting work lights

Mega Beam Xenon-Powerpack

Lens pattern for close-range illumination.

With gas discharge bulb, 500 mm long lead and 2-pole AMP plug.

Light aperture: 83 x 92 mm.

Recommended angle of inclination: 3° - 10°.

Reflector made of diecast aluminium, glued to hardened glass lens.

Black plastic body and red lens-retaining rim, with extending edge to protect lens.

Rear of housing made of black die-cast aluminium.

Xenon electronic unit integrated into housing.

Vibration-damped pivot base with bracket for four-point mounting.

Additionally enclosed, displaceable bracket for single-point attachment.

Type of protection: IP5K4K.

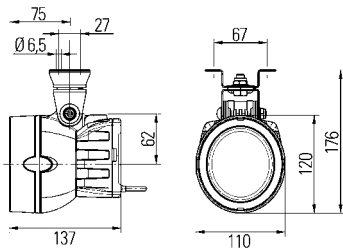
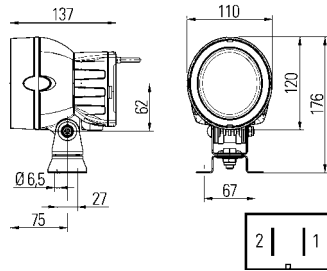

Part no.	Pk.	
1GM 996 135-231	1	Xenon work light, 42W, for upright mounting, with 12V ballast unit
1GM 996 135-251	1	with 24V ballast unit
1GM 996 135-611	1	Xenon work light, 50W, for upright mounting, with 12V ballast unit
1GM 996 135-621	1	with 24V ballast unit
1GM 996 135-241	1	Xenon work light, 42W, for pendant mounting, with 12V ballast unit
1GM 996 135-261	1	with 24V ballast unit
8GS 009 028-021	1	Spare parts: D1S gas discharge bulb, 35W

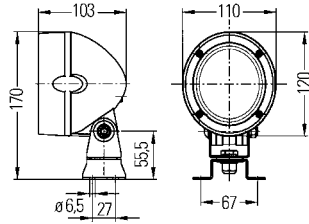

Work lights for upright or pendant mounting

Mega-Beam with FF® reflector

Light aperture: 83 x 92 mm.

Reflector made of diecast aluminium, glued to hardened glass lens. Grey body and cover rim. Black lens-retaining rim with extending edge to protect lens.

Pivot base with vibration damping and bracket for four-point mounting. Pivot range vertical 145°.

Type of protection: IP5K4K and IPX9K.

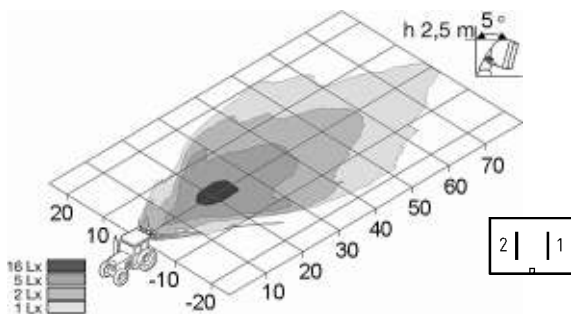
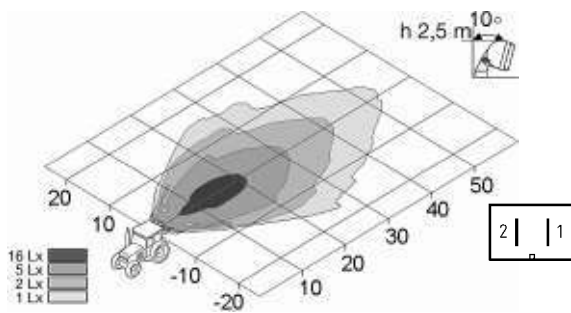
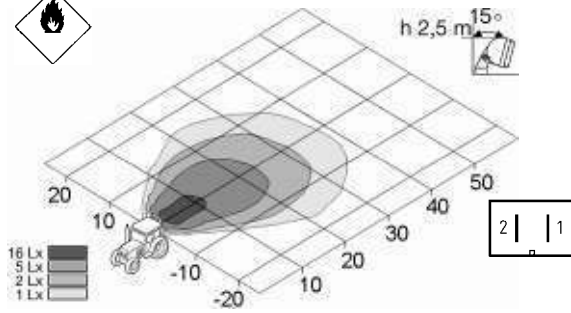

Part no.	Pk.	Description
1GM 996 134-321	1	FF®-H3 work light lens pattern for long-range ground illumination. recommended angle of inclination: 15° - 25°, with grommet
1GM 996 134-171	1	with AMP plug connector and protection cap
1GM 996 134-061	1	FF®-H3 work light with lens pattern for ground illumination. recommended angle of inclination: 10° - 15°, with grommet and lens without optical pattern
1GM 996 134-081	1	with lens without optical pattern, AMP plug connector and cap
1GM 996 134-051	1	FF®-H3 work light with lens pattern for long-range illumination, recommended angle of inclination: 2° - 5°, with grommet and lens without optical pattern
1GM 996 134-071	1	with lens without optical pattern, AMP plug connector and cap
9GH 993 984-001	1	Cap for AMP plug connector
9XD 990 298-001	5	Bracket for four-point fixing
8GH 002 090-271	1	H3 bulb,
8GH 002 090-133	1	12V35W
8GH 002 090-251	1	12V55W
8JD 008 151-011	1	24V70W
8JD 008 151-011	10	Socket for AMP plug connector
8KW 701 235-033	100	Blade receptacles, 6.3 mm
8HG 990 263-111	1	Mounting bracket for tubular mount on 15 mm - 28 mm dia. pipes
8KB 990 299-001	1	2000 mm long connecting lead for AMP plug connector with cap

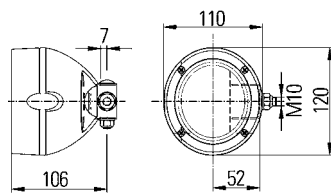
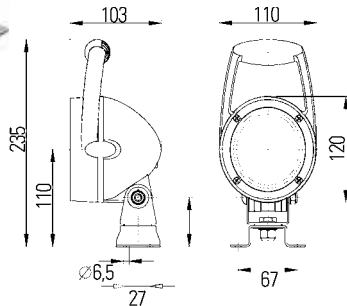
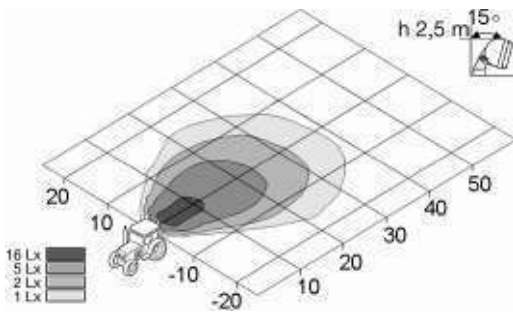

External-fitting work lights

Mega Beam with FF®-reflector

Lens pattern for wide ground illumination.

With grommet. Light aperture: 83 x 92 mm.

Recommended angle of inclination: 15° - 25°.

Reflector made of diecast aluminium, glued to hardened glass lens.

Grey plastic body and cover rim, black plastic lens-retaining rim with extending edge to protect lens.

Type of protection: IP5K4K and IPX9K.

Part no.	Pk.	
1GM 996 134-241	1	FF®-H3 work light with handle, pivot range vertical 145°, pivot base with vibration damping and mounting bracket for four-point mounting for upright or pendant mounting
1GM 996 134-271	1	FF®-H3 work light without vibration damping. Pivot range vertical 90°, inclination range horizontal 170°. With pivoting base at the side and M10 fixing screw for mounting on vertical surfaces, left
1GM 996 134-371	1	right
8GH 002 090-271	1	Accessories: H3 bulb, 12V35W
8GH 002 090-133	1	12V55W
8GH 002 090-251	1	24V70W
8HG 990 263-111	1	Mounting bracket for tubular mount on 15 mm - 28 mm dia. pipes

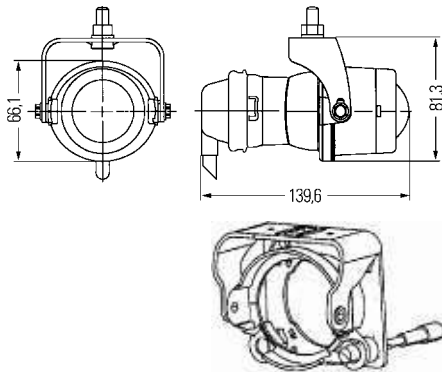
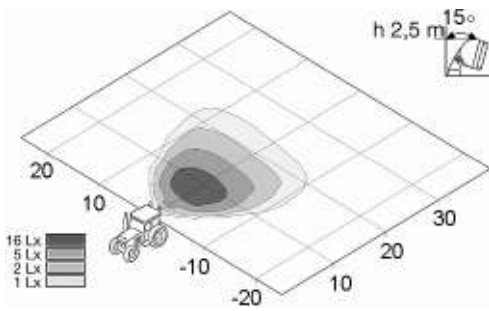

External-fitting work lights

Micro DE

Lens pattern for close-range illumination.
With rubber cap for lead entry. Light aperture: 40 mm dia.
 Recommended angle of inclination: 15° - 20°.
 Black body and lens-retaining rim.
 Lens with body and supporting frame bonded.
 Black bracket with M8 fixing screw.

Part no.	Pk.	
1GL 008 090-201	1	DE®-H3 work light with 12V55W bulb
1GL 008 090-207	60	
1GL 008 090-211	1	with 24V70W bulb
1GL 008 090-217	60	
Spare parts/Accessories:		
		H3 bulb,
8GH 002 090-271	1	12V35W
8GH 002 090-133	1	12V55W
8GH 002 090-251	1	24V70W
9GH 147 009-007	30	Rubber cap for lead entry
9HD 149 253-007	1	Plastic sealing cap with plug
8JD 156 150-807	1	Socket set (20 pcs.)
8HG 153 152-001	1	Convenience mount with adjustment screw

Work lights for upright or pendant mounting

Proflex-Gladiator

Lens pattern for close-range illumination.
Light aperture: 140 mm dia.
 Recommended angle of inclination: 20° - 30°.
 Lens with steel reflector bonded.
 Flexible rubber body with extending edge to protect lens.
 Pivot base with M10 fixing screw.
 Type of protection: IP5K4K.

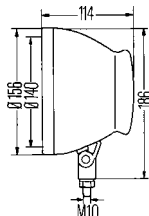
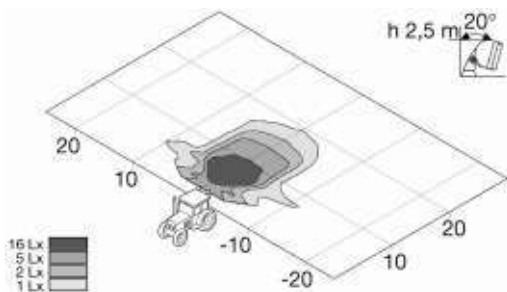

Part no.	Pk.	
1G3 003 710-021	1	H3 work light
Spare parts/Accessories:		
9DS 121 707-001	1	Light unit
9BG 127 179-001	1	Rubber body with universal bracket with fixing screw M10
		H3 bulb,
8GH 002 090-271	1	12V35W
8GH 002 090-133	1	12V55W
8GH 002 090-251	1	24V70W

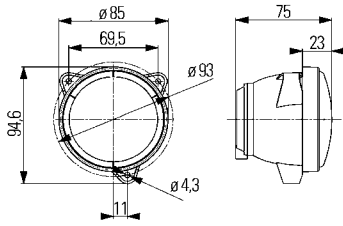

Built-in work lights

Module 70 H3

Without bulb. Light aperture: 77 mm dia.

Reflector made of diecast aluminium, glued to hardened glass lens.
Black plastic body with three-point mounting.

With rubber cap to cover the bulb and for lead entry.

Type of protection: IP5K4K.

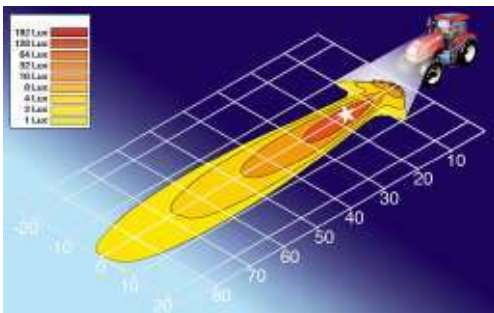
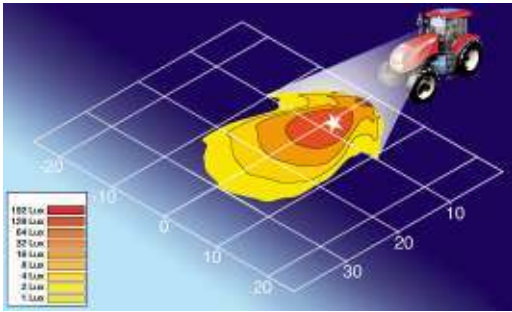

Part no.	Pk.	
1G0 996 176-021	1	H3 work light with lens pattern for close-range illumination
1G0 996 176-031	1	H3 work light with lens pattern for long-range illumination
9HD 990 101-001	2	Spare parts/Accessories: Rubber sealing cap
8GH 002 090-271	1	H3 bulb,
8GH 002 090-133	1	12V35W
8GH 002 090-251	1	12V55W
	1	24V70W

External-fitting work lights

Module 70 H3

Without bulb. Light aperture: 77 mm dia.

Reflector made of diecast aluminium, glued to hardened glass lens.

Black plastic body.

Pivot base with M10 fixing screw.

With rubber cap to cover the bulb.

Type of protection: IP5K4K.

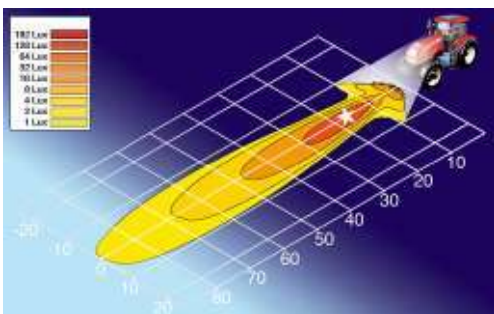
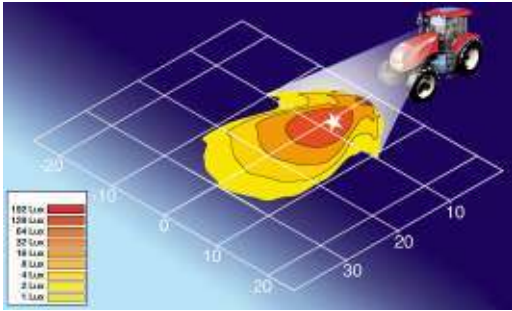

Part no.	Pk.	
1G0 996 176-001	1	H3 work light with lens pattern for close-range illumination, recommended angle of inclination: 10° - 20°, for upright mounting
1G0 996 176-007	24	
1G0 996 176-002	1	Self-service box
1G0 996 176-111	1	H3 work light with lens pattern for close-range illumination, recommended angle of inclination: 10° - 20°, for pendant mounting
1G0 996 176-112	1	
1G0 996 176-011	1	H3 work light with lens pattern for long-range illumination, recommended angle of inclination: 5° - 10°, for upright mounting
1G0 996 176-121	1	
9HD 990 101-001	2	Spare parts/Accessories:
9XD 990 298-001	5	
8HG 990 263-111	1	
8GH 002 090-271	1	
8GH 002 090-133	1	
8GH 002 090-251	1	

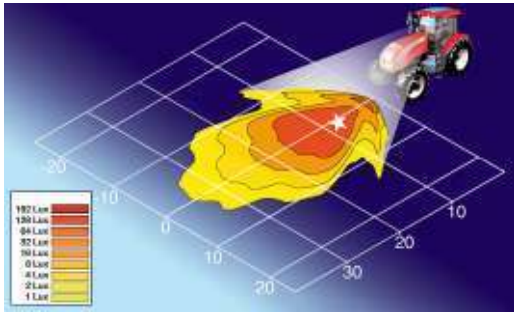

External fitting work lights for upright mounting

Module 70 Xenon

Lens pattern for close-range illumination.

With gas discharge bulb.

Light aperture: 77 mm dia.

Recommended angle of inclination: 10° - 20°.

Reflector made of diecast aluminium, glued to hardened glass lens.

Black plastic body.

Pivot base with M10 fixing screw.

Work light permanently connected to ballast unit by a (1000 mm -361 / 500 mm -621/-631) long lead.

The lead can be disconnected from the ballast unit by means of a plug-connection.

Without connecting lead. Type of protection: IP5K9K.

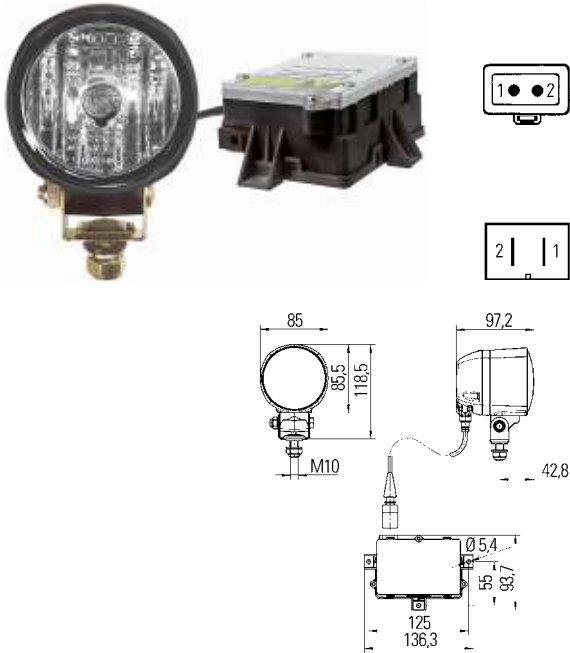

Part no.	Pk.	
1G0 996 176-361	1	Xenon work light, 42W, with DEUTSCH plug connector and 12V ballast unit
1G0 996 176-621	1	Xenon work light, 50W, with AMP plug connector and 12V ballast unit
1G0 996 176-631	1	and 24V ballast unit
Spare parts/Accessories:		
8GS 009 028-021	1	D1S gas discharge bulb, 35W
5DV 008 855-001	1	Vorschaltgerät (for D1S)
8KB 990 299-221	1	3700 mm connecting lead with relay, DEUTSCH plug connector and fuse 15A, 12V

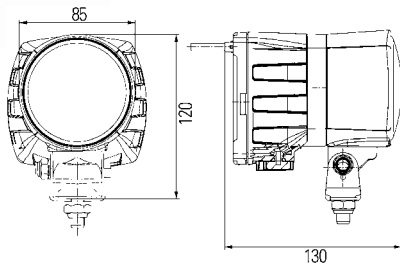
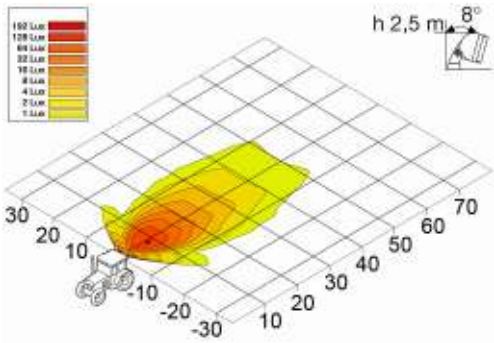

External fitting work lights for upright mounting

Module 70 Xenon Powerpack

Lens pattern for close-range illumination.
With 500 mm long lead, AMP plug connector and gas discharge bulb.
Light aperture: 77 mm dia.

Reflector made of die-cast aluminium, glued to hardened glass lens.
 Black plastic body,
 rear of body made of diecast aluminium.
 Pivot base with M10 fixing screw.
 Xenon electronic unit integrated into body.

Part no.	Pk.	
1G0 996 176-681	1	Xenon-work light with 12V ballast unit
1G0 996 176-691	1	with 24V ballast unit
8GS 009 028-021	1	Spare parts: D1S gas discharge bulb, 35W

Work light for pendant surface mounting

Module 70 Xenon

For long-range illumination.
With AMP plug connector and gas discharge bulb.
Light aperture: 77 mm dia.

Reflector made of die-cast aluminium, glued to hardened glass lens.
 Black plastic body,
 rear of body made of diecast aluminium.
 Pivot base with M10 fixing screw.
 Xenon electronic unit integrated into body.

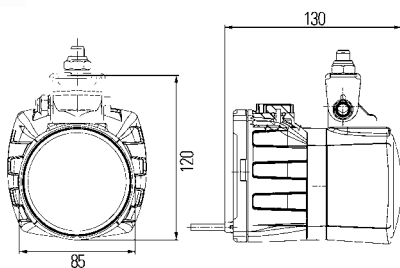

Part no.	Pk.	
1G0 996 276-357	1	Xenon-work light with 12V ballast unit
8GS 009 028-021	1	Spare parts: D1S gas discharge bulb, 35W

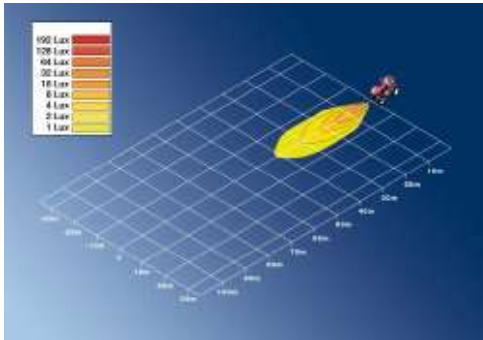

External-fitting work lights

Module 70 LED

Lens pattern for close-range illumination.
With four LEDs. Light aperture: 77 mm dia.
 4-part reflector made of plastic, glued to glass lens without optical pattern.
 Black finish aluminium body with cooling ribs.
 Pivot base with M10 fixing screw.
 With 2000 mm long connecting lead. Type of protection: IP5K4K.
 Voltage range: 12V - 24V.

Part no.	Pk.	
1G0 996 176-701	1	LED work light, 7W, 180 lm, for upright mounting
1G0 996 176-711	1	for pendant mounting
1G0 996 176-721	1	LED work light, 15W, 600 lm, for upright mounting
1G0 996 176-723	1	LED work light, 15W, 600 lm, for upright mounting, Self-service box
1G0 996 176-741	1	for pendant mounting

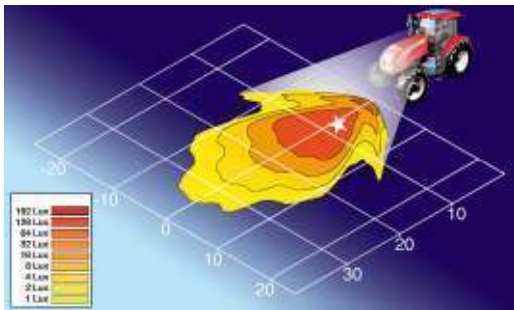

Built-in work lights

Module 70 H9

Lens pattern for close-range illumination.
With 12V bulb. Light aperture: 77 mm dia.
 Reflector made of diecast aluminium, glued to hardened glass lens.
 Black plastic body with three-point fixing.
 With rubber cap to cover the bulb and for lead entry.
 Type of protection: IP5K9K.

Part no.	Pk.	
1G0 996 176-061	1	H9 work light
Spare parts/Accessories:		
8GH 008 357-001	1	H9 bulb, 12V65W
9XD 990 298-001	5	Bracket for four-point fixing
8HG 990 263-111	1	Mounting bracket for tubular mount on 15 mm - 28 mm dia. pipes
8JD 158 175-807	1	H9 socket set (20 pcs.)
9GH 990 334-011	1	Rubber cap for H9 socket

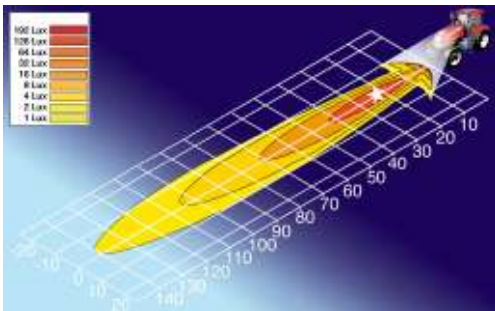
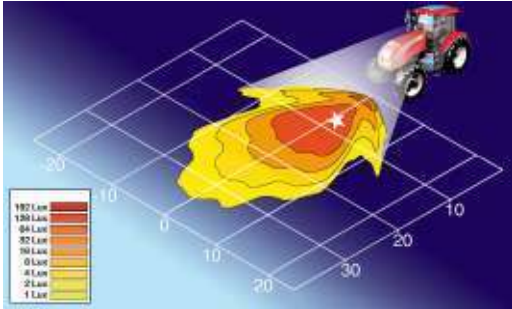

External-fitting work lights

Module 70 H9

With 12V bulb, accessible from the outside.

Light aperture: 77 mm dia.

Reflector made of diecast aluminium, glued to hardened glass lens.

Black plastic body.

Pivot base with M10 fixing screw.

With rubber cap to cover the bulb and for lead entry.

Type of protection: IP5K9K.

Part no.	Pk.	
		H9 work light with lens pattern for close-range illumination, recommended angle of inclination: 10° - 20°, for upright mounting
1G0 996 176-041	1	
1G0 996 176-131	1	for pendant mounting
1G0 996 176-171	1	with 2000 mm long connecting lead and H9 plug, for upright mounting
1G0 996 176-181	1	with 2000 mm long connecting lead and H9 plug, for pendant mounting
<hr/>		
		H9 work light with lens pattern for long-range illumination, recommended angle of inclination: 5° - 10°, for upright mounting
1G0 996 176-051	1	
1G0 996 176-671	1	with blue lens, for upright mounting
1G0 996 176-141	1	for pendant mounting
		Spare parts/Accessories:
8GH 008 357-001	1	H9 bulb, 12V65W
9XD 990 298-001	5	Bracket for four-point fixing
		Mounting bracket for tubular mount on
8HG 990 263-111	1	15 mm - 28 mm dia. pipes
8JD 158 175-807	1	H9 socket set (20 pcs.)
9GH 990 334-011	1	Rubber cap for H9 socket

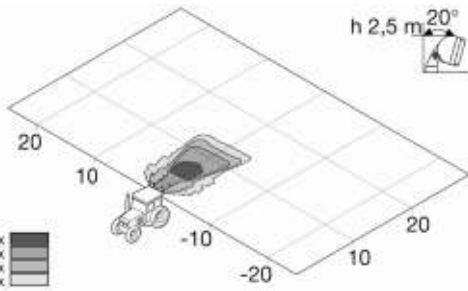

Work lights for upright or pendant mounting

W131

Lens pattern for close-range illumination.
With grommet. Light aperture: 129 mm dia.
 Recommended angle of inclination: 20° - 30°.
 Plastic lens with steel reflector bonded.
 Black plastic body and handle,
 with extending edge to protect lens.
 Pivot base with M10 fixing screw.
 Without vibration damping.
 Pivot range vertical 105°.

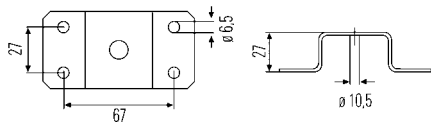
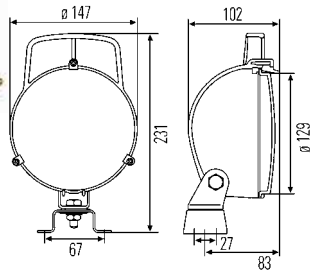

Part no.	Pk.	
1G3 996 001-131	1	F2 work light with switch
1G3 996 001-001	1	without switch
		Spare parts/Accessories:
8GA 002 083-131	1	F2 bulb,
8GA 002 083-251	1	12V35W
8HG 990 003-001	2	24V35W
		Bracket for four-point fixing
1G3 996 001-391	1	H3 work light with switch
1G3 996 001-041	1	without switch
		Spare parts/Accessories:
8GH 002 090-271	1	H3 bulb,
8GH 002 090-133	1	12V35W
8HG 990 003-001	2	12V55W
		Bracket for four-point fixing

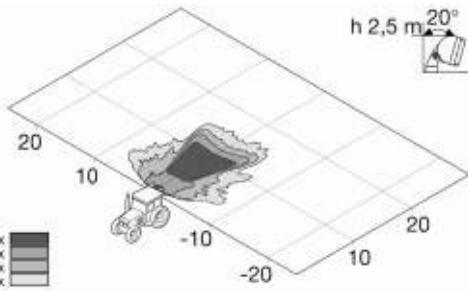

Work lights for upright or pendant mounting

W131

**Lens pattern for close-range illumination.
With grommet. Light aperture: 129 mm dia.**

Recommended angle of inclination: 20° - 30°.
Plastic lens with steel reflector bonded.
Black plastic body and handle, with extending edge to protect lens.
Pivot base with M10 fixing screw.
Without vibration damping.
Pivot range vertical 105°.

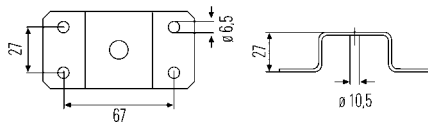
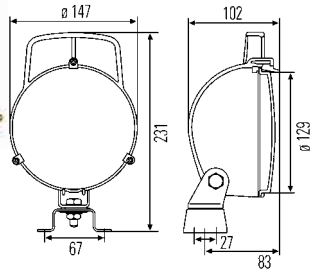

Part no.	Pk.	
1G3 996 001-331	1	H3 work light with switch
1G3 996 001-271	1	without switch
Accessories:		
8GH 002 090-271	1	H3 bulb, 12V35W
8GH 002 090-133	1	12V55W
8HG 990 003-001	2	Bracket for four-point fixing
<hr/>		
1G3 996 001-351	1	H3 work light with protective grill and switch
1G3 996 001-301	1	with protective grill, without switch
Spare parts/Accessories:		
9AG 990 006-017	24	Lens-retaining rim with protective grill
8GH 002 090-271	1	H3 bulb, 12V35W
8GH 002 090-133	1	12V55W
8GH 002 090-251	1	24V70W
8HG 990 003-001	2	Bracket for four-point fixing

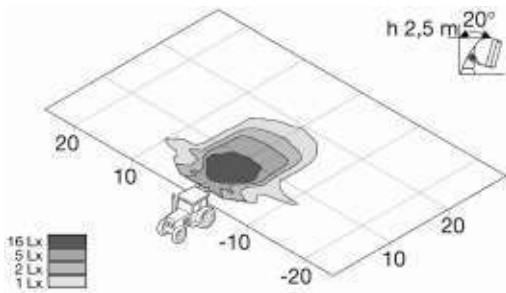

Work lights for upright or pendant mounting

Matador

Lens pattern for close-range illumination. With grommet. Light aperture: 140 mm dia.

Recommended angle of inclination: 20° - 30°. Steel reflector with glass lens bonded.

Black plastic body and protective grille with extending edge to protect lens.

With pivot base, without vibration damping.

Pivot range vertical 130°. Type of protection: IP5K4K.

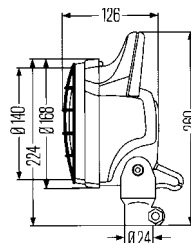
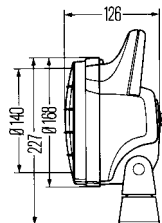
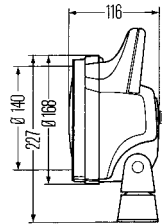

Part no.	Pk.	
1G4 003 470-001	1	H3 work light with bracket for four-point mounting, without protective grill, with splash-proof rotary switch
1G4 003 470-011	1	without switch
1G4 003 470-031	1	H3 work light with bracket for four-point mounting and protective grill, with splash-proof rotary switch
1G4 003 470-051	1	without switch
Spare parts/Accessories:		
9DS 121 707-001	1	Light unit
6EB 005 633-001	10	Switch
9XD 130 261-001	5	Bracket for four-point fixing
		H3 bulb,
8GH 002 090-271	1	12V35W
8GH 002 090-133	1	12V55W
8GH 002 090-251	1	24V70W
1G4 003 470-141	1	H3 work light with protective grill, spigot mount and 24V70W bulb, without switch. Electrical contacts inside tubular mount over socket (DIN 72 591)
1G4 003 470-147	24	
Spare parts:		
9DS 121 707-001	1	Light unit
8GH 002 090-251	1	H3 bulb, 24V70W

Work lights for upright or pendant mounting

Torro II

Optik für Nahfeldausleuchtung.
With grommet. Light aperture: 133 mm dia.
 Recommended angle of inclination: 15° - 30°.
 Lens with steel reflector bonded.
 Black plastic body and handle.
 With pivot base, without vibration damping.
 Pivot range vertical 130°. Type of protection: IP5K4K.

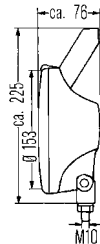
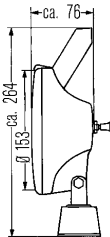
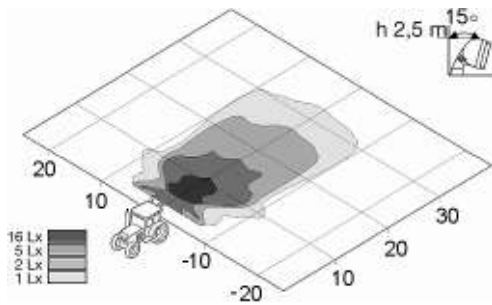

Part no.	Pk.	
1G4 004 480-001	1	H3 work light with bracket for four-point mounting and splash-proof switch
9XD 130 261-001	5	Spare parts/Accessories: Bracket for four-point fixing
8GH 002 090-271	1	H3 bulb, 12V35W
8GH 002 090-133	1	12V55W
8GH 002 090-251	1	24V70W
1G4 004 480-011	1	H3 work light with M10 fixing screw, without switch
8GH 002 090-271	1	Accessories: H3 bulb, 12V35W
8GH 002 090-133	1	12V55W
8GH 002 090-251	1	24V70W

External-fitting work lights

7033

Lens pattern for close-range illumination.
Light aperture: 140 mm dia.
 Recommended angle of inclination: 10° - 30°.
 Black plastic body.
 Two M6 fixing screws.

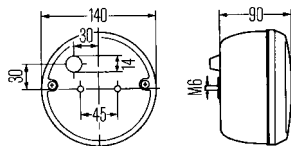
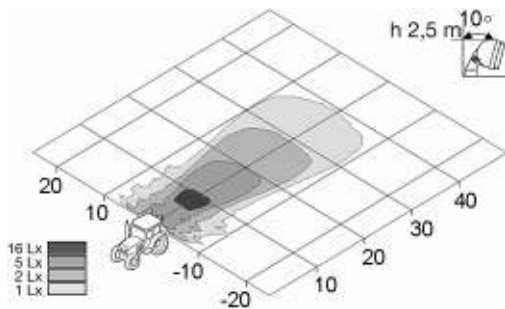

Part no.	Pk.	
1G4 997 033-011	1	H3 work light
8GH 002 090-271	1	Accessories: H3 bulb, 12V35W
8GH 002 090-133	1	12V55W

Accessories see page 4.123 - 4.125

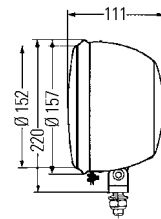
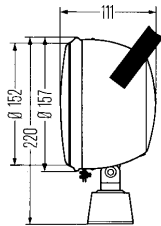
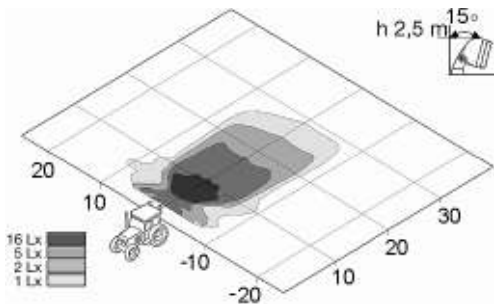

Work lights for upright or pendant mounting

Lens pattern for close-range illumination. With grommet. Light aperture: 152 mm dia.

Recommended angle of inclination: 20° - 25°. Steel body with matt black finish.

Steel reflector with glass lens bonded.

Rubber boot prevents lateral scattered light.

With pivot base, without vibration damping.

Pivot range vertical 130°. Type of protection: IP5K4K.

Part no.	Pk.	
1G5 003 241-081	1	H3 work light with bracket for four-point mounting, handle and splash-proof switch
Spare parts/Accessories:		
1G5 120 510-001	1	Light unit with seal
9GD 120 670-001	10	Gasket
6ED 708 919-001	5	Switch
		H3 bulb,
8GH 002 090-271	1	12V35W
8GH 002 090-133	1	12V55W
8GH 002 090-251	1	24V70W
1G5 003 241-071	1	H3 work light with M10 fixing screw, without handle and switch
Spare parts/Accessories:		
1G5 120 510-001	1	Light unit with seal
9GD 120 670-001	10	Gasket
		H3 bulb,
8GH 002 090-271	1	12V35W
8GH 002 090-133	1	12V55W
8GH 002 090-251	1	24V70W

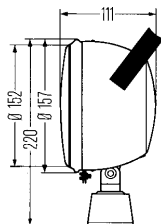
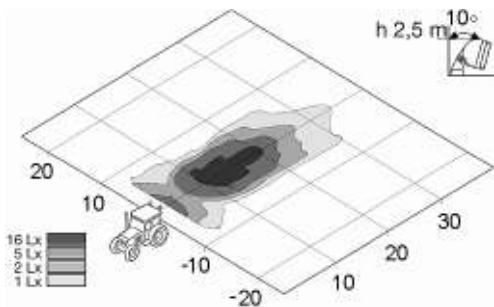

Lens pattern for far-reaching illumination. With grommet. Light aperture: 152 mm dia.

Recommended angle of inclination: 15° - 20°. Steel body with matt black finish.

Steel reflector with glass lens bonded.

Rubber boot prevents lateral scattered light.

With pivot base, without vibration damping.

Pivot range vertical 130°. Type of protection: IP5K4K.

Part no.	Pk.	
1G5 003 241-021	1	H3 work light with bracket for four-point mounting, handle and splash-proof switch
Spare parts/Accessories:		
1G5 119 738-001	1	Light unit with seal
9GD 120 670-001	10	Gasket
6ED 708 919-001	5	Switch
		H3 bulb,
8GH 002 090-271	1	12V35W
8GH 002 090-133	1	12V55W
8GH 002 090-251	1	24V70W

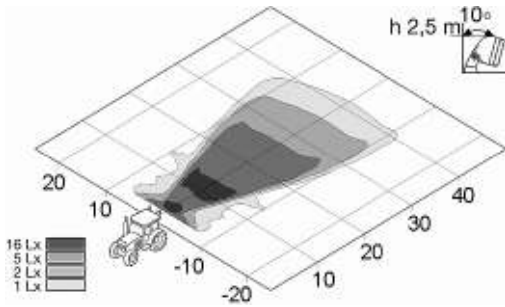

Work lights for upright or pendant mounting

**Lens pattern for far-reaching illumination.
With grommet. Light aperture: 180 mm dia.**

Recommended angle of inclination: 10° - 20°.
Steel body with matt black finish.

Steel reflector with glass lens bonded.

Rubber boot prevents lateral scattered light.

With pivot base, without vibration damping.

Pivot range vertical 130°. Type of protection: IP5K4K.

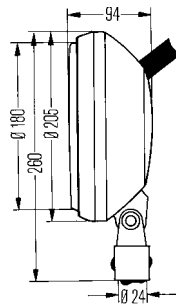
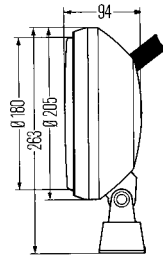

Part no.	Pk.	
1G8 002 340-001	1	H3 work light with bracket for four-point mounting
1G8 002 340-011	1	H3 work light with 2500 mm rubber tube, 2-pole low voltage plug 8JA 001 925-001 (Pk.2) and mounting clamp for mounting on 24 mm dia. standard pin, as well as on 30 mm dia. standard pin after removing reducing sleeve from pipe fitting
1G8 132 233-011	1	Spare parts/Accessories: Light unit with lens-retaining rim
8GH 002 090-271	1	H3 bulb, 12V35W
8GH 002 090-133	1	12V55W
8GH 002 090-251	1	24V70W

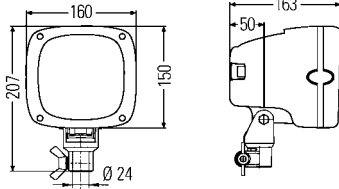
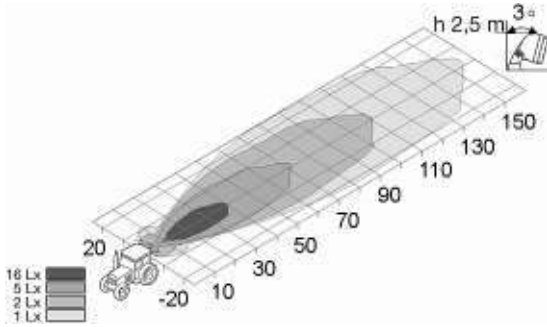

External-fitting work lights

AS 200 Xenon

Lens pattern for long-range illumination.

With gas discharge bulb, 24V ballast unit and 200 mm connecting lead. Light aperture: 123 x 123 mm.

Recommended angle of inclination: 3° - 10°.

Plastic reflector with glass lens bonded.

Black plastic body with extending edge to protect lens. With red decorative ring. Handle recessed into body.

Xenon electronic unit 24V42W integrated into body.

With pivot base and bracket.

Switch with integrated fuse 15A.

With 2500 mm rubber tube and 2-pole low voltage plug 8JA 001 925-001.

Easy-to-loosen pipe fitting mount 24 mm dia., fits 30 mm dia. attachment pin in combination with joint 9XS 027 639-001.

Can be used with tripod 8XT 002 117-001 and 8XT 002 120-001 as well as socket 8XT 002 121-001.

Type of protection: IP5K4K and IPX9K.

Part no.	Pk.	
1GA 996 142-221	1	Xenon-work light
Spare parts/Accessories:		
1GA 990 305-011	1	Light unit
8GS 007 949-101	1	D2S gas discharge bulb, 35W
8JA 001 925-001	1	Plug, 2-pole
8JS 711 687-821	1	Blade-type fuses, 15A (5 pcs.)
9XS 027 639-001	1	Joint

Work Lights for mounting

Conforms to DIN 14 644.

Light aperture: 250 mm dia.

750 m range with 12V55W

800 m range with 24V70W.

Flat lens without optical pattern. Steel reflector.

Black finish steel body and lens retaining rim.

Two side handles, built-in switch.

2500 mm long lead with low voltage plug 8JA 001 925-001 (Pk. 2).

Easy-to-loosen pipe fitting mount 24 mm dia., fits 30 mm dia. attachment pin in combination with joint 9XS 027 639-001.

Can be used with tripod 8XT 002 117-001 and 8XT 002 120-001 as well as socket 8XT 002 121-001.

Type of protection: IP5K4K.

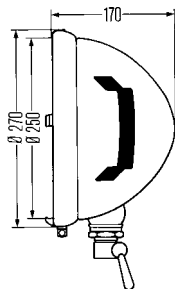

Part no.	Pk.	
1G9 001 523-021	1	H3 work light
Spare parts/Accessories:		
8JA 001 925-001	1	Plug, 2-pole
8GH 002 090-271	1	H3 bulb,
8GH 002 090-133	1	12V35W
8GH 002 090-251	1	12V55W
8GH 002 090-251	1	24V70W
9XS 027 639-001	1	Joint

Accessories

For work lights

1GA 996 142-221, 1G9 001 523-021, 1G8 002 340-011



Part no.	Pk.	
8XT 002 120-001	1	Extends from 1263 mm to 2200 mm, with 30 mm dia. attachment pin, can be welded onto vehicle or fastened with clights. Tubular steel pipe
8XT 002 117-001	1	Extends from 1051 mm to 1650 mm. 30 mm dia. attachment pin. Tubular steel tripod
8XT 002 121-001	1	For mounting work light on vehicle roof or other horizontal body surface, with 30 mm dia. attachment pin. Socket
9XS 027 639-001	1	With 24 mm dia. attachment pin and 30 mm dia. attachment sleeve. swiveling 180°, with handle, lockable. Joint
8HG 159 455-001	1	With M10 thread. For 30 mm dia. attachment sleeve. Universal holder

Accessories

Mounting bushes 24 mm dia

for Matador 1G4 003 470-147,
Ultra Beam 1GA 007 506-681 and bracket
attachment foot 8HG 990 320-001.
With socket to DIN 72 591 and
rubber protective cap.



Part no.	Pk.	
8HG 002 365-001	1	Mounting bush for mounting on support side of the vehicle or for welding to a flange, 24 mm dia., approx. 100 mm, with ground contact through the pipe
8HG 006 294-101	1	with separate ground connection
8HG 096 531-007	2	Spare parts/Accessories: Mounting bush for -001
8JB 850 434-011	10	Socket for -001
9GH 096 532-001	10	Rubber cap
8HG 006 294-051	1	Mounting bush with screw fixing and ground contact through the pipe
8HG 006 294-091	1	and separate ground connection
8HG 006 294-011	1	For screwing onto horizontal cabin roofs (on top)
8HG 006 294-021	1	Mounting bush for screwing onto horizontal cabin roofs (on side) with 90 mm mounting bracket
8HG 006 294-111	1	with 50 mm mounting bracket
8HG 006 294-031	1	Mounting bush for screwing onto horizontal cabin roofs (on top or on side). Swivelling holder
8HG 006 294-041	1	Length: 1000 mm. Extension: up to 700 mm. For screwing onto back of cabin roof. Telescopic holder
8HG 990 368-001	1	Black, with M8 thread. Length: 220 mm. Mounting bush
8HG 990 368-007	25	
9XD 990 284-001	1	With stopper for screwing to vertical vehicle surfaces (side). With protective cap, 1-pole socket and wiring harness with ground contact. Attachment using two M8 bolts
8JB 850 434-011	10	Spare parts: Socket
9GH 096 532-001	10	Rubber cap
9NM 863 332-001	1	For work lights with tubular fitting or flexible base. Contents: Wing nut with screw and washer. Accessory group

Accessories

Bracket attachment foot

For combination with attachment tubes
 8HG 002 365-001 and 8HG 006 294-...
 To fit surface-mount work lights
 Ultra-Beam FF® 1GA 007 506-..., 1GA 997 506-...
 Ultra Beam H9 1GA 996 150-...
 Mega-Beam FF® 1GA 996 134-...
 Oval 100 FF® 1GA 996 161-...
 AS 200 FF® 1GA 998 532-...
 AS 200 Xenon 1GA 996 142-...
with AMP plug connector or grommet.
 Electrical contacting within the pipe socket via
 socket in accordance with DIN 72 591.



Part no.	Pk.	
8HG 990 320-001	1	Bracket attachment foot

Universal bracket

To fit surface mount work lights
 Oval 100 FF® 1GA 996 161-..., 1GA 996 361-...
 Oval Xenon Integral 1GA 996 261-...
 Picador FF® 1GA 006 876-..., 1GA 998 522-...
 AS 200 FF® 1GA 998 532-...
 AS 200 Xenon 1GA 996 142-...
 Ultra-Beam FF® 1GA 007 506-..., 1GA 997 506-...
 Ultra Beam H9 1GA 996 150-...
 Mega-Beam FF® 1GA 996 134-...
 Modul 70 H3/H9 1G0 996 176-...
 Rotatable universal bracket for attachment to 15 mm - 28 mm dia. pipes.
 For replacement on worklights with 36 mm bracket attachment.
 With 2 additional narrow spacers for exchange
 against wide spacers with/without vibration damping on worklights
 with 42 mm bracket attachment.

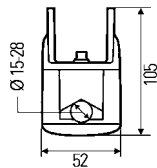

Part no.	Pk.	
8HG 990 263-111	1	Universal bracket

Magnet bracket

For work lights with U-bracket or for U-bracket
 9XD 130 261-001.
 Consists of: 2 magnets and fixing material.

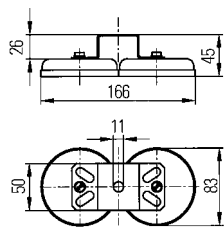

Part no.	Pk.	
8HG 004 806-001	1	Magnet bracket

Accessories

Bracket for four-point fixing

for external-fitting headlights and work lights with M10 fixing screw.

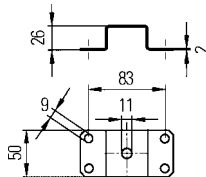
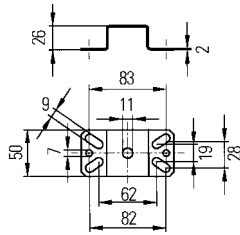

Part no.	Pk.	
9XD 130 261-001	5	Bracket for four-point fixing made of stainless steel
9XD 990 298-001	5	made of yellow chromised steel

Universal radio remote control unit

The hella remote control unit is ECE type tested and carries the RF suppression symbol.

The alternating code feature excludes interference with other remote controls. The convenient way to switch work lights by remote control.

Maximum switching capacity: 2 x 100W.

With green control diode for on-off switching control.



Part no.	Pk.	
6ZN 160 705-001	1	Universal radio remote control unit, 12V
6ZN 160 705-011	1	24V
6ZN 160 707-001	1	Spare parts: Radio remote control, 12V

Hand-held searchlights

With 12V bulbs, conversion to 24V is possible.

Light aperture: 139 mm dia.

Range at 12V:

continuous light 330 m, additional light 350 m,
continuous light with additional light 480 m.

Black plastic body, lens-retaining rim, handle and supporting base.

Extending lens-retaining rim protects the lens.

Glass lens without optical pattern.

Double reflector made of aluminium.

Two light sources, can be switched via switches which are independent of each other. Flip switch for continuous light and pistol switch in the handle with morse function for additional light.

Handle can be swivelled vertically by 70°.

With closable opening for plugging onto the separate supporting base.

Can be swivelled horizontally by 360° on the supporting base.

Supporting base with 3 fixing screws.

Spiral lead 3500 mm long with universal plug for cigarette lighter sockets or ISO sockets.

Type of protection: IPX6K.

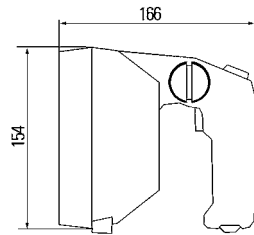

Part no.	Pk.	
1H5 998 502-002	1	H3 hand-held searchlight
Spare parts/Accessories:		
8HG 998 519-002	1	Supporting base with fixing screws
9SG 998 005-002	1	Handle with switch, spirally lead and plug
8JA 001 921-102	12	Connector
8GH 002 090-133	1	H3 bulb, 12V55W
8GH 002 090-251	1	24V70W

Cabin-controlled searchlights

Light aperture: 139 mm dia.

Range at 12V: 460 m,

range at 24V: 520 m.

Black plastic body, lens-retaining rim, handle and tie rod end.

Guide tube made of stainless steel.

Projecting lens-retaining rim protects the lens.

Glass lens without optical pattern.

Double reflector made of aluminium.

Flip switch in the handle switches both bulbs simultaneously.

The searchlight can be swivelled through 360° in the horizontal range and through 30° in the vertical range.

Mounting area: 72 mm dia.

Connecting lead 330 mm long with grommet led out of the guide tube.

Type of protection: IP5K4K.

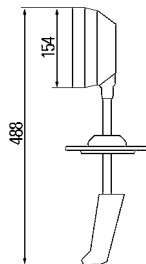









Part no.	Pk.	
1H5 998 502-022	1	H3 cabin-controlled searchlight with 181 mm long guide tube and 12V55W bulbs
1H5 998 502-051	1	with 233 mm long guide tube and 24V70W bulbs
Spare parts:		
8GH 002 090-133	1	H3 bulb, 12V55W
8GH 002 090-251	1	24V70W



<p>Combination lights - index</p> <p>Regulations and information on LED signal lights</p> <p>Direction indicators to ECE</p>	<p>5.02-5.04</p> <p>5.05-5.07</p> <p>5.173</p>
<p>Signal lights</p> <p>Combinable lights</p> <p>Side-marker lights</p> <p>Rear-, clearance- and position lights</p> <p>Position lights</p> <p>Daytime running lights</p> <p>Licence plate lights</p> <p>Clearance lights</p> <p>Track-control lights</p> <p>Rear fog and reverse lights</p> <p>Reverse lights</p> <p>Safety break lights</p> <p>Indicator lights</p> <p>Handlebar indicator lights</p> <p>Auxiliary indicators</p> <p>Indicator- position lights</p> <p>Interior lights</p> <p>Reading lights</p> <p>Handlights</p> <p>Door lights</p> <p>Warning lights</p> <p>Hazard flasher lights</p> <p>Emergency triangles</p> <p>Reflectors</p>	<p>5.08-5.54</p> <p>5.55-5.137</p> <p>5.138-5.140</p> <p>5.141-5.144</p> <p>5.145-5.146</p> <p>5.147-5.152</p> <p>5.153-5.157</p> <p>5.158-5.161</p> <p>5.162</p> <p>5.163-5.166</p> <p>5.167-5.168</p> <p>5.169-5.172</p> <p>5.174-5.179</p> <p>5.180</p> <p>5.181-5.183</p> <p>5.184-5.185</p> <p>5.186-5.212</p> <p>5.213-5.215</p> <p>5.216-5.219</p> <p>5.220-5.222</p> <p>5.223-5.225</p> <p>5.226-5.227</p> <p>5.228</p> <p>5.229-5.234</p>

Combinable Lights Index



	"343 640" series	5.22-5.24
	"006 040" series	5.25-5.27
	"007 547" series	5.28
	"998 232" series	5.43
	"998 233" series	5.43
	"959 037" series "959 050" series "980 605" series "980 606" series "980 607" series	5.55-5.56
	"002 582" series	5.57
	"003 184" series	5.58
	"997 131" series	5.59
	"997 006" series	5.60
	"003 182" series	5.61
	"002 776" series	5.62
	"003 185" series	5.63
	"003 018" series	5.63

		"008 405" series	5.64
		"008 221" series	5.65-5.66
		"009 001" series	5.67-5.71
		"965 039" series	5.72-5.73
		"001 423" series	5.74
		"959 010" series "959 011" series	5.75
		"344 200" series	5.76-5.79
		"964 169" series "344 169" series	5.79-5.86
		"959 820" series "959 821" series "959 822" series "959 950" series	5.87
		"001 240" series	5.88
		"343 390" series "343 130" series	5.89-5.96
		"001 259" series	5.97-5.99
		"003 057" series	5.100
		"003 014" series	5.102-5.103
		"996 012" series	5.104
		"003 236" series "005 200" series	5.105-5.107
		"004 431" series "004 432" series	5.108-5.109

Combinable Lights Index



		"008 982" series	5.109-5.110
		"008 805" series	5.111
		"005 603" series "004 119" series	5.112-5.113
		"003 734" series	5.114-5.115
		"962 964" series	5.116
		"006 717" series	5.117
		"997 027" series	5.118
		"003 748" series	5.119
		"963 959" series	5.120
		"004 361" series	5.121
		"963 639" series "340 001" series	5.122-5.124
		"340 000" series	5.125
		"008 645" series	5.126-5.128
		"343 690" series	5.129-5.130
		"964 295" series	5.131-5.132
		"959 790" series "959 590" series "959 640" series	5.134-5.135
		"003 389" series	5.136-5.137



Instruction 1 - Regarding LED technology multi-function lamps

In connection with these low powers, which are very different from bulb versions, there can be problems with the bulb failure check during operation on various traction vehicles.

Since indicator failure checks are required by legislation, we recommend only operating the light in combination with an indicator control unit part no. "5DS 009 602-..., 5DS 009 552-... or LED flasher unit 4.. 009 492".

In addition, further lighting functions are detected by some traction vehicles. This is a vehicle comfort function which is not required by legislation and does not release drivers from their obligation to see for themselves that the lighting equipment is working.

Here, too, faulty diagnoses can be a result of the lower power levels involved (instrument panel in the driver cab indicates a bulb failure although the function is working).

Operation of the light with alternating current or pulsed direct current is not permitted!
The functional ability of these light failure checks can only be established by the vehicle manufacturer.
The individual light functions may only be operated with a vehicle fuse of max. 3A.

In the case of onboard current limitation with the values specified above by the onboard control unit an additional fuse for the lamp is not required.

Instruction 2 - Regarding single or double function lamps with LEDs without flasher function

In connection with these low powers, which are very different from bulb versions, there can be problems during operation on various traction vehicles because further lighting functions are detected by some traction vehicles.

This is a vehicle comfort function which is not required by legislation and does not release drivers from their obligation to see for themselves that the lighting equipment is working.

Here, too, faulty diagnoses can be a result of the lower power levels involved (instrument panel in the driver cab indicates a bulb failure although the function is working).

The functional ability of these light failure checks can only be established by the vehicle manufacturer.

Operation of the light with alternating current or pulsed direct current is not permitted!
The individual light functions may only be operated with a vehicle fuse of max. 3A.

In the case of onboard current limitation with the values specified above by the onboard control unit an additional fuse for the lamp is not required.

Instruction 3 - Regarding flasher lights with LEDs with active electronics

In connection with these low powers, which are very different from bulb versions, there can be problems with the bulb failure check during operation on various traction vehicles.

Since indicator failure checks are required by legislation, we recommend only operating the light in combination with an indicator control unit part no. "5DS 009 602-..., 5DS 009 552-... or LED flasher unit 4.. 009 492".

Operation of the light with alternating current or pulsed direct current is not permitted!
The individual light functions may only be operated with a vehicle fuse of max. 3A.

Instruction 4

In connection with these low powers, which differ significantly from those of a bulb-based version, problems arise with the indicator failure check during operation on various traction vehicles.

The indicator failure check required by legislation in the area of validity of the ECE R48 regulation must be guaranteed by suitable measures within the vehicle. The customer is responsible for this.

In addition, further lighting functions are detected by some traction vehicles.

This is a vehicle comfort function which is not required by legislation and does not release drivers from their obligation to see for themselves that the lighting equipment is working.

Here, too, faulty diagnosis can occur on account of the low power levels involved (instrument panel in the driver cab indicates light failure although the function is working).

Operation of the light with AC voltage or synchronised DC voltage is not permitted.
The individual light functions may only be operated with a vehicle fuse of max. 3A.

Legal requirement in all ECE states

In the case of vehicles approved for use on public roads, the indicators must be monitored: The failure of an indicator must be shown optically or acoustically in the vehicle. This applies in all ECE states. In other words, the potential failure of the indicator must be monitored by the vehicle. Manufacturers use various failure control systems. The failure control systems currently in use cannot detect simple LED lights and displays a fault. All Hella LED indicators have integrated electronics for failure control. The indicators are selfmonitoring. They generate a pulse that is evaluated by the electronic ballast. The ballast simulates a 21W bulb, which makes operation with conventional flasher units possible. As soon as one single LED fails, the light can be considered faulty, the pulse is not generated. The ballast then switches the bulb simulation off and the flasher unit indicates the fault to the driver.

Safe conversion to LED indicators now possible thanks patented Hella electronics

Hella supplies electronic ballasts for all Hella LED indicators which make it possible to convert the indicator failure display for various vehicles. This is necessary if the vehicle manufacturer does not guarantee indicator bulb failure control via the vehicle wiring system. The method has been patented for Hella. At the moment, there are three different ballasts and several different LED indicator types available.

LED indicator failure control: Background information

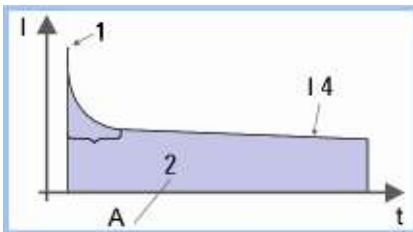

Fig. 1

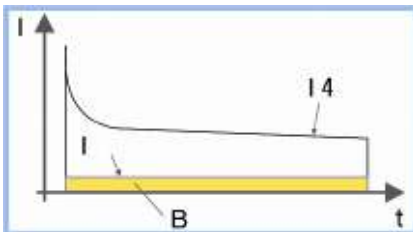

Fig. 2

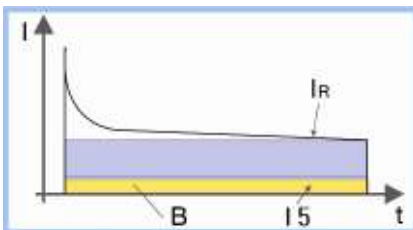

Fig. 3

I = Current
t = Time
1 = Pulse peak
2 = Switch-on pulse
3 = Individual pulse
4 = Bulb
5 = LED

Why does the failure detection required by law work with various LED lights with some flasher units and not with others?

Fig. 1 illustrates the typical current pattern when a bulb is switched on. Different flasher units detect this in different ways, for example by
a) measuring the pulse peak or
b) measuring the current at some point during the switch-on pulse or
c) measuring the current after the pulse, when the current is constant and has a certain intensity, or
d) determining the total energy flowing through the light (size of area A)

Fig. 2 shows the LED current (I_{LED}) in relation to this. None of the methods mentioned above can work here, because there is neither a switch-on pulse available nor is the current intensity high enough or the total energy through both lights is identical (area B is as large as A).

If a simple Ohmic resistor is inserted, e.g. a resistor cable, the current is increased by a certain value (IR) and the curve illustrated in Fig. 3 is the result. In this case, only a flasher unit according to principle c) would work. If the resistance is chosen somewhat higher, principle d) could also possibly work. If the light fails afterwards due to mechanical damage, the flasher unit could detect the insert resistor as a functional bulb. In this case, a light working perfectly would be indicated although this is not the case! This means: In this case the vehicle would lose this approval for use on public roads.

The only solution conceivable for universal use is one that works with all the flasher units on the market. As the above considerations have shown, this can practically only be guaranteed if the current pattern of a bulb is simulated exactly by means of an electronic circuit.

Since such a circuit is extremely complex, it is not possible to integrate this in the LED light. In order to be able to benefit from the advantages of LED lights despite this fact, a ballast is required to the circuit. This combination provides the perfect - and above all legally conform - solution to the problem.

Hella patent for the perfect problem solution

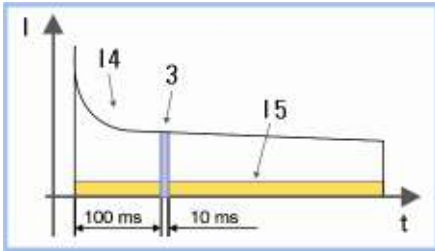

Fig. 4

- I = Current
- t = Time
- 1 = Pulse peak
- 2 = Switch-on pulse
- 3 = Individual pulse
- 4 = Bulb
- 5 = LED

All Hella LED indicators with integrated electronics for failure control are self-monitoring and generate an individual pulse. This pulse is evaluated by the electronic ballasts. The ballasts simulate a 21 W bulb.

This makes operation with conventional flasher units possible.

If the light is faulty, which can be the case if only a single LED fails, the above-mentioned pulse is not generated. The ballasts then switch the bulb simulation off and the flasher unit indicates the LED fault to the driver.

By measuring the light current during a time window of 10 ms (Fig. 4), direct exchange between the Hella LED light and a bulb version is possible.

Hella ballasts are straightforward to convert even at a later date.

Vehicle manufacturers can also ensure ECE-conform failure control by evaluating the pulse of the Hella LED indicators shown in the adjacent diagram directly in their control units.

The exact specification can be obtained from Hella.

Which Hella ballast for which vehicle?



1. Vehicles that use the cold scan for indicator failure control.

Description of fault indication:

Is a faulty light indicated when the ignition is switched on or directly when the fault occurs, or when the bulb is screwed out without the indicator being triggered?

Solution: Simulation device for cold scan

Part no.	Pk.	
5DS 009 602-011	1	Simulation device for cold scan, 12V
5DS 009 602-001	1	24V



2. Vehicles without flasher unit that carry out current measurement as failure control.

Description of fault indication:

Is a fault only determined during flashing (e.g. double flashing frequency)?

Solution: Indicator control unit

5DS 009 552-001	1	Indicator control unit for trucks and trailers, 24V, with one 15-pole EasyConn plug and one 15-pole Easy-Conn socket
5DS 009 552-011	1	Lead end with blade terminal contact 6.3 mm

No separate power supply necessary.
Protective rating: IP 6K9K



3. Vehicles with flasher unit

Solution: Replacement of the existing flasher unit by an LED flasher unit

4DN 009 492-101	1	LED-flasher unit, 12V 2+1+1
4DW 009 492-111	1	LED-flasher unit, 12V 3+1
4DM 009 492-001	1	LED-flasher unit, 24V 2+1
4DW 009 492-011	1	LED-flasher unit, 24V 3+1

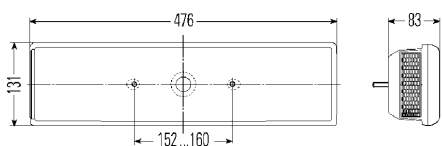

**For horizontal or vertical flush mounting
in towing vehicles and mobile homes**

**Red reflector, rear, stop, rear fog
and clearance light, amber indicator
and side-marker light
and white reverse light.**

Two M8 fixing screws.

Part no.	Pk.	
2VP 007 323-091	1	Rear-reflector-stop-indicator-rear fog-reverse-clearance-side-marker light, left
2VP 007 323-101	1	right
Spare parts/Accessories:		
9EL 146 887-001	1	Lens
8GA 002 071-121	10	R5W bulb, 12V
8GA 002 071-241	10	24V R10W bulb,
8GA 002 071-131	10	12V
8GA 002 071-251	10	24V P21W bulb,
8GA 002 073-121	10	12V
8GA 002 073-241	10	24V

For horizontal surface mounting on towing vehicles



Red reflector, rear, stop, rear fog and clearance light, amber indicator and side-marker light and white reverse light.

Two M8 fixing screws.

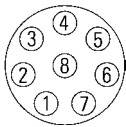
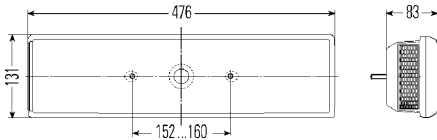

1	indicator	amber
2	rear/licence plate/clearance/side-marker	brown
3	stop	red
4	rear fog	blue
5	reverse	black
6	-	not used
7	-	not used
8	ground	white

Part no.	Pk.	
2VP 007 323-011	1	Rear-reflector-stop-indicator-rear fog-reverse-clearance-side-marker light, left
2VP 007 323-021	1	right
2VP 007 323-111	1	Rear-reflector-stop-indicator-rear fog-reverse- and clearance light, with 8-pole, black central plug and 24V bulbs, left
2VP 007 323-121	1	right
2VD 007 323-031	1	Rear-reflector-stop-indicator-rear fog-reverse-clearance light and side-marker light with reflector, with illumination for 520 x 120 mm and 340 x 240 mm licence plates, left
2VD 007 323-041	1	right
2VD 007 323-131	1	Rear-reflector-stop-indicator-rear fog-reverse-clearance light and side-marker light with reflector, with illumination for 520 x 120 mm and 340 x 240 mm licence plates, with 8-pole, black central plug and 24V bulbs, left
2VD 007 323-141	1	right
		Spare parts/Accessories:
9EL 146 887-001	1	Lens
9EL 146 838-001	2	Side-marker light with reflector R5W bulb,
8GA 002 071-121	10	12V
8GA 002 071-241	10	24V R10W bulb,
8GA 002 071-131	10	12V
8GA 002 071-251	10	24V P21W bulb,
8GA 002 073-121	10	12V
8GA 002 073-241	10	24V



For horizontal surface mounting on towing vehicles

Red reflector, rear, stop, rear fog and clearance light, amber indicator and side-marker light with reflector, white reverse light, illumination for 520 x 120 mm licence plates.

Black plastic body.
Two M8 fixing screws.

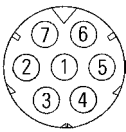

1	ground	white
2	rear/licence plate/clearance/side-marker	brown
3	reverse	amber
4	indicator	green
5	stop	red
6	rear fog	blue
7	-	not used

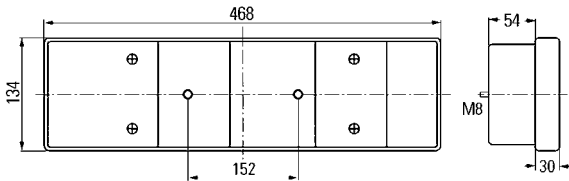

Part no.	Pk.	Description
2VD 008 204-231	1	Rear-reflector-stop-indicator-rear fog-reverse-clearance light and 7-pole, side-mounted AMP-plug for RVI vehicles, with licence plate illumination, left
2VP 008 204-221	1	without licence plate illumination, right
2VD 008 204-211	1	Rear-reflector-stop-indicator-rear fog-reverse-clearance light without plug, however with PG fitting, and cable input, with licence plate illumination, left
2VP 008 204-201	1	without licence plate illumination, right
2VD 008 204-251	1	Rear-reflector-stop-indicator-rear fog-reverse-clearance light with 7-pole, side-mounted AMP-plug for DAF and MAN vehicles, with licence plate illumination, left
2VP 008 204-241	1	without licence plate illumination, right
9EL 152 889-001	1	Spare parts/Accessories: Lens with screws
8GA 002 071-121	10	R5W bulb, 12V
8GA 002 071-241	10	24V R10W bulb, 12V
8GA 002 071-131	10	12V
8GA 002 071-251	10	24V P21W bulb, 12V
8GA 002 073-121	10	12V
8GA 002 073-241	10	24V

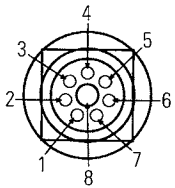
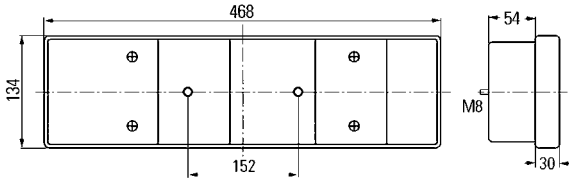

1	indicator	amber
2	rear/licence plate/clearance/side-marker	black
3	stop	red
4	rear fog	blue
5	reverse	grey
6	-	not used
7	-	not used
8	ground	white

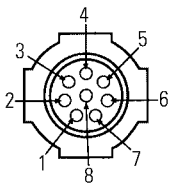

1	clearance/side-marker	green
2	indicator	amber
3	stop	red
4	reverse	black
5	-	not used
6	-	not used
7	-	not used
8	ground	white
9	rear fog	blue
10	rear	brown



For horizontal surface mounting on towing vehicles

Red reflector, rear, stop, rear fog and clearance light, amber indicator light, white reverse light, illumination for 520 x 120 mm licence plates. Black plastic body. Two M8 fixing screws.

Part no.	Pk.	
2VD 008 204-051	1	Rear-reflector-stop-indicator-rear fog-reverse-clearance light with 8-pole AMP-plug for MAN and Scania vehicles, with licence plate illumination, left and right
2VP 008 204-041	1	without licence plate illumination, left and right
2VD 008 204-071	1	Rear-reflector-stop-indicator-rear fog-reverse-clearance light with 8-pole AMP-plug for MAN and Scania vehicles, with licence plate illumination, left
2VP 008 204-061	1	without licence plate illumination, left and right
2VD 008 204-131	1	Rear-reflector-stop-indicator-rear fog-reverse-clearance light with rear fog light and licence plate illumination, left
2VP 008 204-121	1	without rear fog light and licence plate illumination, left and right
2VD 008 204-151	1	Rear-reflector-stop-indicator-rear fog-reverse-clearance light with Scania cable input left
2VD 008 204-141	1	right
2VD 008 204-171	1	Rear-reflector-stop-indicator-rear fog-reverse-clearance light with 8-pole special-plug for DAF vehicles, with licence plate illumination, left
2VP 008 204-161	1	without licence plate illumination, left and right
2VD 008 204-191	1	Rear-reflector-stop-indicator-rear fog-reverse-clearance light with 10-pole AMP-plug for Iveco-vehicles, with licence plate illumination, left
2VP 008 204-181	1	without licence plate illumination, right
9EL 152 889-001	1	Spare parts/Accessories: Lens with screws R5W bulb,
8GA 002 071-121	10	12V
8GA 002 071-241	10	24V P21W bulb,
8GA 002 073-121	10	12V
8GA 002 073-241	10	24V

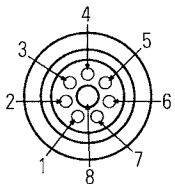
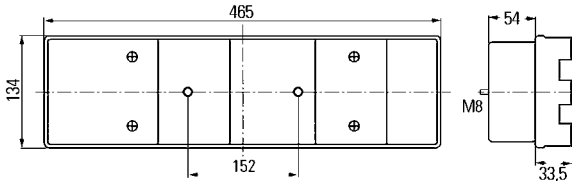

1	indicator	amber
2	rear/licence plate/clearance/side-marker	black/green-red/brown
3	stop	red
4	rear fog	blue
5	reverse	grey
6	-	not used
7	-	not used
8	ground	white

For horizontal surface mounting on towing vehicles

Red reflector, rear, stop, rear fog and clearance light, amber indicator and side-marker light with reflector, white reverse light, illumination for 520 x 120 mm licence plates.

Cable entry through central body opening, without grommet.

Black plastic body.

Two M8 fixing screws.

Part no.	Pk.	
2VD 008 204-111	1	Rear-reflector-stop-indicator-rear fog-reverse-clearance light, with side-marker light and reflector, for Mercedes-Benz vehicles, with rear fog light and licence plate illumination, left
2VP 008 204-101	1	without rear fog light and licence plate illumination, right
2VD 008 204-091	1	Rear-reflector-stop-indicator-rear fog-reverse-clearance light, with side-marker light and reflector, with 8-pole Schlemmer-plug for Mercedes-Benz vehicles, with licence plate illumination, left
2VP 008 204-081	1	without licence plate illumination, right
9EL 152 891-001	1	Spare parts/Accessories: Lens with screws
8GA 002 071-121	10	R5W bulb, 12V
8GA 002 071-241	10	24V
8GA 002 073-121	10	P21W bulb, 12V
8GA 002 073-241	10	24V



For horizontal surface mounting on towing vehicles

Red reflector, rear, stop, rear fog and clearance light, amber indicator and side-marker light with reflector, white reverse light, with illumination for 520 x 120 mm licence plates.

Black plastic body.
Two M8 fixing screws.

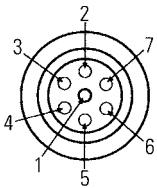

1	ground	white
2	indicator	green
3	stop	red
4	rear/licence plate/clearance/side-marker	brown
5	reverse	amber
6	rear fog	blue
7	-	not used

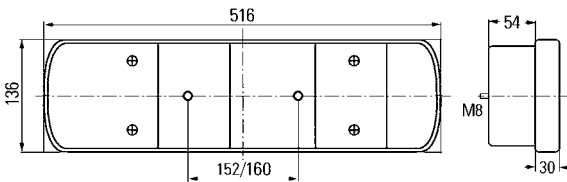

Part no.	Pk.	
2VD 008 205-011	1	Rear-reflector-stop-indicator-rear fog-reverse-clearance light, with side-marker light and reflector, distance between screws 152 mm, left
2VD 008 205-021	1	right
2VD 008 205-051	1	Rear-reflector-stop-indicator-rear fog-reverse-clearance light, with side-marker light and reflector, with 7-pole AMP-plug, distance between screws 160 mm, left
2VD 008 205-041	1	right
2VP 008 205-031	1	Rear-reflector-stop-indicator-rear fog-reverse-clearance light, with side-marker light and reflector, distance between screws 160 mm, with 7-pole plug, left and right
9EL 152 884-001	1	Spare parts/Accessories: Lens with screws
8GA 002 071-121	10	R5W bulb, 12V
8GA 002 071-241	10	24V
8GA 002 071-131	10	R10W bulb, 12V
8GA 002 071-251	10	24V
8GA 002 073-121	10	P21W bulb, 12V
8GA 002 073-241	10	24V



Red reflector, rear, stop, rear fog and clearance light, amber indicator and side-marker light with reflector, white reverse light.

With 4 vibration dampers, 8-pole Schlemmer-plug and 24V bulbs. Two bulbs for rear and stop light.

Black plastic body.
Two M8 fixing screws.

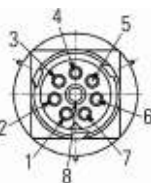
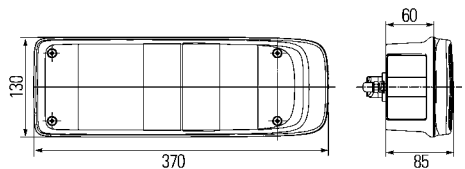

1	indicator	yellow/green
2	rear	brown
3	stop	red
4	rear fog	blue
5	reverse	pink
6	-	not used
7	-	not used
8	ground	white



Part no.	Pk.	
2VP 340 888-011	1	Rear-reflector-stop-indicator-rear fog-reverse light and side-marker light with reflector, left
2VP 340 888-017	12	
2VP 340 888-001	1	right
2VP 340 888-007	12	
8GA 002 073-241	10	P21W bulb, 24V
8GA 002 071-251	10	R10W bulb, 24V
8GP 002 067-241	10	T4W bulb, 24V

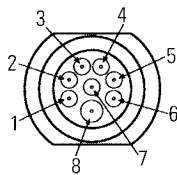
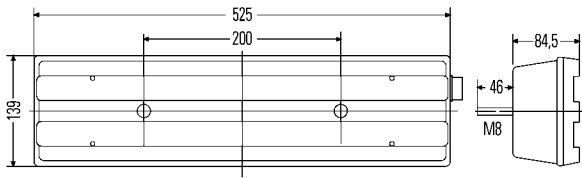

1	indicator	black/white
2	rear/licence plate/clearance/side-marker	green/black
3	-	not used
4	rear fog	yellow/black/white
5	reverse	white/red
6	ground	brown
7	stop	black/red
8	-	not used

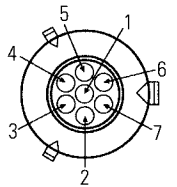

1	ground	brown
2	rear/clearance/side-marker	green
3	reverse	black
4	indicator	red
5	stop	yellow
6	rear fog	white
7	licence plate	green

2VD 007 500-411



1	ground	brown
2	rear/clearance/side-marker	green
3	reverse	black
4	indicator	red
5	stop	yellow
6	-	not used
7	-	not used

2VP 007 500-421/-521



**For horizontal surface mounting on towing vehicles
Also permissible for trailers in combination
with valid EC component homologation for lighting**

Red reflector, rear, stop, rear fog and clearance light,
amber indicator light, white reverse light,
with illumination for 520 x 120 mm licence plates.
With side mounted amber reflector.

With vibration dampers and 24V bulbs.

When used in right-hand traffic, the licence plate
window in the right-hand light must be covered
with the black cover plate 9EL 134 301-011 (Pk. 1),
order separately!

Black plastic body.

Two M8 fixing screws.

Part no.	Pk.	
2VD 007 500-091	1	Rear-reflector-stop-indicator-rear fog-reverse-clearance-licence plate light with side mounted amber reflector and 1200 mm lead with 8-pole round plug, left
2VD 007 500-201	1	right
2VD 007 500-111	1	Rear-reflector-stop-indicator-rear fog-reverse-clearance-side-marker light with reflector-licence plate light, with 1200 mm lead and 8-pole round plug, left
2VD 007 500-221	1	right
2VD 007 500-411	1	Rear-reflector-stop-indicator-rear fog-reverse-clearance-side-marker light with reflector, with 7-pole, amber centre plug and grommets on side, with rear fog- and licence plate light, left
2VP 007 500-421	1	without rear fog- and licence plate light, right
2VP 007 500-521	1	Rear-reflector-stop-indicator-rear fog-reverse-clearance-side-marker light with reflector, with backup alarm and electronics for reducing volume at night, right
Spare parts/Accessories:		
9EL 134 296-041	1	Lens with screws, left
9EL 134 296-051	1	right
9EL 146 838-001	2	Lens for side-marker light for -111/-221/-411/-421 -> 12/2007
9EL 134 301-001	1	Lens for licence plate illumination, for -091/-111/-201/-221/-411
9GT 074 132-001	10	Grommet for -091/-201/-111/-221
9EL 134 301-011	1	Cover plate, black
8GA 002 071-131	10	R10W bulb, 12V
8GA 002 071-251	10	24V
8GA 002 073-121	10	P21W bulb, 12V
8GA 002 073-241	10	24V



For horizontal surface mounting

Red reflector, rear, stop, rear fog and clearance light, amber indicator light, white reverse light, with illumination for 520 x 120 mm licence plates. With amber side-marker reflector.

When used in right-hand traffic, the licence plate window in the right-hand light must be covered with the black cover plate 9EL 134 301-011 (Pk. 1), order separately!

Two M8 fixing screws.

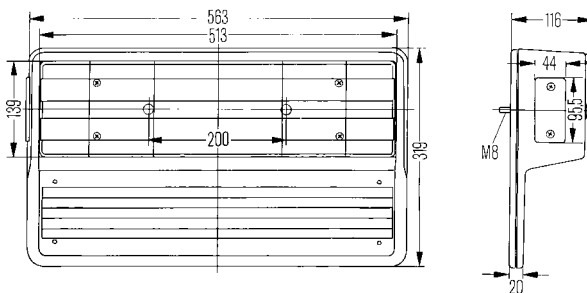

Part no.	Pk.	
		Rear-reflector-stop-indicator-rear fog-licence plate-reverse-clearance light with side-marker reflector, left
2VD 005 300-551	1	
2VD 005 300-581	1	right
		Spare parts/Accessories:
		Lens with screws,
9EL 134 296-041	1	left
9EL 134 296-051	1	right
9EL 134 301-001	1	Lens for licence plate illumination
8RA 003 326-011	20	Reflector
9EL 134 301-011	1	Cover plate, black
8GA 002 071-131	10	12V
8GA 002 071-251	10	24V
8GA 002 073-121	10	12V
8GA 002 073-241	10	24V



Red rear, stop and rear fog light, amber indicator light, white reverse light. With rectangular Volvo-central plug.

Black plastic body. Two M6 fixing screws.

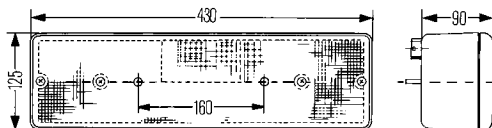

8	7	6	5	1	ground
•	•	•	•	2	rear
•	•	•	•	3	rear
•	•	•	•	4	rear fog
•	•	•	•	5	stop
•	•	•	•	6	indicator
•	•	•	•	7	reverse
•	•	•	•	8	ground

Part no.	Pk.	
		Rear-stop-indicator-rear fog-reverse light with illumination for 520 x 120 mm and 340 x 240 mm licence plates, for horizontal surface mounting, left
2SL 005 883-031	1	
2SL 005 883-041	1	right
		Rear-stop-indicator-rear fog-reverse light for horizontal or vertical surface mounting, left
2SK 005 883-011	1	
2SK 005 883-021	1	right
		Spare parts/Accessories:
9EL 135 548-001	1	Lens
		R5W bulb,
8GA 002 071-121	10	12V
8GA 002 071-241	10	24V
		P21W bulb,
8GA 002 073-121	10	12V
8GA 002 073-241	10	24V



For horizontal surface mounting

Red reflector, rear, stop and rear fog light, amber flasher light and white reverse light.
Black plastic body, without grommet.
Two M8 fixing screws.

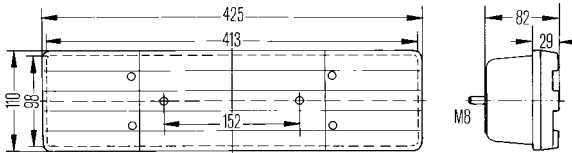

Part no.	Pk.	
2VB 004 887-011	1	Rear-reflector-stop-indicator-rear fog-lens plate light, left
2VA 004 887-031	1	Rear-reflector-stop-indicator-rear fog light, left
2VP 004 887-021	1	Rear-reflector-stop-indicator-reverse light, right
Spare parts/Accessories:		
		Lens with screws,
9EL 131 420-001	1	left
9EL 131 420-011	1	right
9GT 141 941-001	10	Grommet
8GA 002 073-121	10	P21W bulb, 12V
8GA 002 073-241	10	P21W bulb, 24V
8GA 002 071-131	10	R10W bulb, 12V
8GA 002 071-251	10	R10W bulb, 24V

For horizontal surface mounting on trailers

Rear Logic

Red reflector, rear, stop and rear fog light, clear indicator light (with auxiliary lens) and reverse light. Black plastic body.
With vibration dampers and grommet.

Black plastic body.
Two M8 fixing screws.

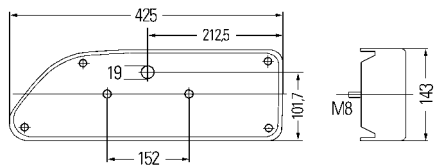

Part no.	Pk.	
2VP 007 907-031	1	Rear-triangular reflector-indicator-rear fog-reverse light, left
2VP 007 907-037	12	
2VP 007 907-041	1	right
2VP 007 907-047	12	
Spare parts/Accessories:		
		Lens,
9EL 150 965-001	1	left
9EL 150 966-001	1	right
8GA 002 073-251	10	P21W bulb, 24V
8GD 002 078-241	10	P21/5W bulb, 24V
8GD 002 078-011	10	P21/5W bulb, 24V (HD)

For horizontal surface mounting on trailers

Europoint

Red reflector, rear, stop, rear fog and clearance light, amber indicator light and side-marker light with reflector, white reverse light.

Two bulbs for rear and stop light.

With double vibration damping.

Black plastic body.

Two M8 fixing screws.

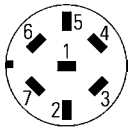
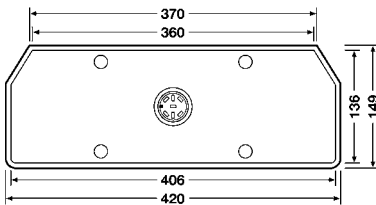

1	ground	white
2	stop	red
3	indicator	yellow
4	reverse	grey
5	rear fog	blue
6	rear	black
7	side-marker/ clearance/ licence plate	brown



Part no.	Pk.	
2VD 008 789-011	1	Rear-reflector-stop-indicator-rear fog-reverse-clearance-side-marker-licence plate light with 7-pole plug and 24V bulbs, left
2VP 008 789-051	1	Rear-reflector-stop-indicator-rear fog-reverse-clearance-side-marker light with 7-pole plug and 24V bulbs, left
2VP 008 789-021	1	right
2VP 008 789-071	1	Rear-reflector-stop-indicator-rear fog-reverse-clearance-side-marker light with PG- screwed connections, without plug and bulbs, left
2VP 008 789-041	1	right
Spare parts/Accessories:		
9EL 158 993-001	1	Lens with additional amber lens and expansion dowel
8GA 002 071-241	10	R5W bulb, 24V
8GA 002 071-251	10	R10W bulb, 24V
8GA 002 073-241	10	P21W bulb, 24V
8GD 002 078-241	10	P21/5W bulb, 24V

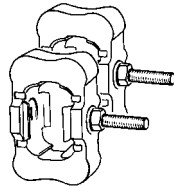
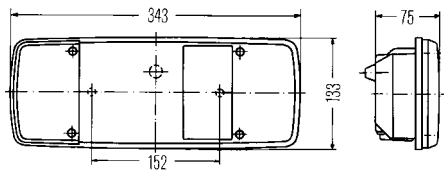

For horizontal, without licence plate illumination also for vertical mounting on towing vehicles, indicator light above

Also permissible for trailers in combination with valid EC component homologation for lighting.

Red reflector, rear, stop, rear fog light, amber indicator light, white reverse light.

Black plastic body. Two M8 fixing screws.

Part no.	Pk.	
2VP 003 567-111	1	Rear-reflector-stop-indicator-rear fog-reverse light, left
2VP 003 567-121	1	right
2VP 003 567-127	18	
<hr/>		
2VD 003 567-377	18	Rear-reflector-stop-indicator-rear fog-reverse-licence plate light, two bulbs for rear light, left
Spare parts/Accessories:		
9EL 122 689-021	2	Lens with screws for -111/-121/-127
9GP 003 995-801	1	External vibration dampers Kit comprising: 2 each with M8 fixing screw
8GA 002 071-131	10	R10W bulb, 12V
8GA 002 071-251	10	24V
8GA 002 073-121	10	P21W bulb, 12V
8GA 002 073-241	10	24V

**For horizontal, without licence plate illumination
also for vertical mounting on trailers,
indicator light above**

**Red rear, stop and rear fog light,
amber indicator light, white reverse light.**
Black plastic body. Two M8 fixing screws.

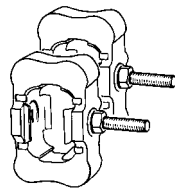
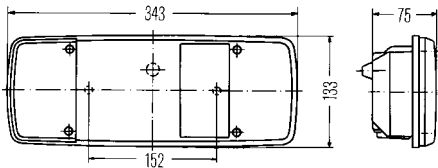

Part no.	Pk.	
2SK 003 567-331	1	Rear-stop-indicator-rear fog-reverse light, left
2SK 003 567-321	1	right
2SK 003 567-651	1	Rear-stop-indicator-rear fog-reverse light, Two bulbs for rear light, left
2SK 003 567-661	1	right
2SL 003 567-311	1	Rear-stop-indicator-rear fog-reverse light, with licence plate illumination, left
2SL 003 567-691	1	Rear-stop-indicator-rear fog-reverse light, with licence plate illumination Two bulbs for rear light, left
9EL 122 772-001	2	Spare parts/Accessories: Lens with screws
9GP 003 995-801	1	External vibration dampers Kit comprising: 2 each with M8 fixing screw
8GA 002 071-131	10	R10W bulb, 12V
8GA 002 071-251	10	24V
8GA 002 073-121	10	P21W bulb, 12V
8GA 002 073-241	10	24V

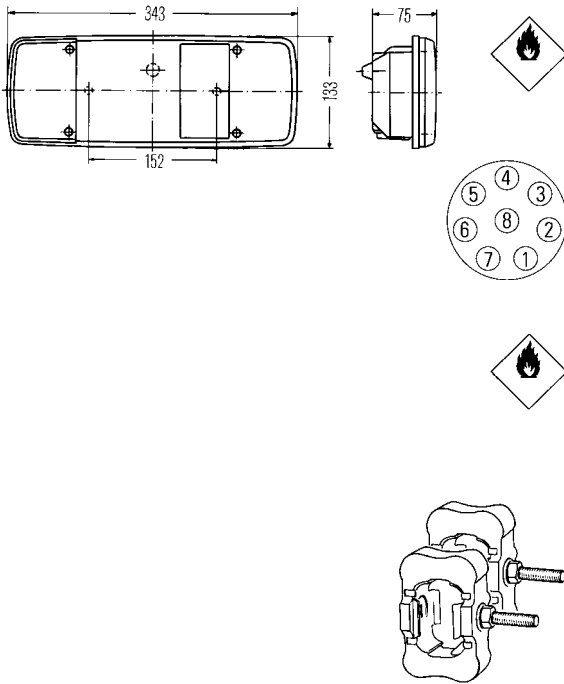

For horizontal flush/surface mounting on towing vehicles and trailers

Lens with various functions, left or right. Red rear, reflector, stop and rear fog light, amber indicator light, white reverse light.

Black plastic body, with centre plug.

Without fixing screws.

Please plug the existing licence plate opening with cover 9HB 126 601-001 if not used.

Part no.	Pk.	
9EL 122 689-051	2	Lenses with reflector for towing vehicles: for rear-reflector-stop-indicator-reverse light
9EL 122 689-021	2	for rear-reflector-stop-indicator-rear fog-reverse light
9BG 130 945-001	2	Body for lenses with reflector: left
9BG 130 946-001	2	right
9EL 122 772-051	2	Lenses without reflector for trailers: for rear-stop-indicator-reverse light
9EL 122 772-001	2	for rear-stop-indicator-rear fog-reverse light
9HB 126 601-001	2	Accessories: Cover for licence plate opening
9GP 003 995-801	1	External vibration dampers Kit comprising: 2 each with M8 fixing screw
8GA 002 071-131	10	R10W bulb, 12V
8GA 002 071-251	10	24V
8GA 002 073-121	10	P21W bulb, 12V
8GA 002 073-241	10	24V

For horizontal or vertical surface mounting

Red rear and stop light, amber indicator light.

Licence plate opening can be replaced with red lens included loose.

Black plastic body.

Two M8 fixing screws.

Two bulbs for tail light.

With PG11- screwed connections.

For older Scania models.

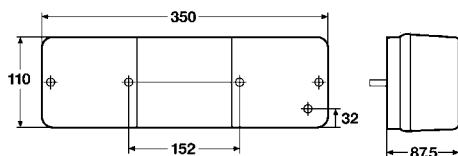

Part no.	Pk.	
2SE 997 088-001	1	Rear-stop-indicator-licence plate light, left and right
8GA 002 071-131	10	Accessories: R10W bulb, 12V
8GA 002 071-251	10	24V
8GA 002 073-121	10	P21W bulb, 12V
8GA 002 073-241	10	24V

For horizontal surface mounting

Red rear and stop light, amber indicator light.

Black plastic body.
Two M6 fixing screws. With grommet.
Two bulbs for rear light.

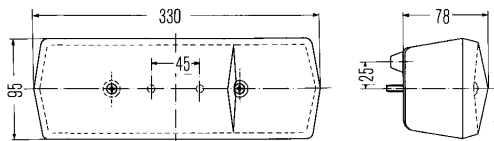

Part no.	Pk.	
2SD 001 688-171	1	Rear-stop-indicator light, left
2SD 001 688-141	1	right
<hr/>		
With illumination for 520 x 120 mm and 340 x 240 mm licence plates,		
2SE 001 688-151	1	left
2SE 001 688-161	1	right
Spare parts/Accessories:		
9EL 092 435-011	1	Lens with screws
9GD 102 484-001	10	Gasket for lens
9GT 074 132-001	10	Grommet
8GA 002 071-121	10	R5W bulb, 12V
8GA 002 071-241	10	R5W bulb, 24V
8GA 002 073-121	10	P21W bulb, 12V
8GA 002 073-241	10	P21W bulb, 24V

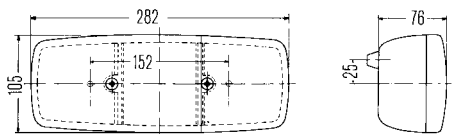

Red rear and stop light, amber indicator light.

Black plastic body, with gasket.
Bulb holder with vibration damping.
Two M8 fixing screws.

Part no.	Pk.	
2SD 001 699-511	1	Rear-stop-indicator light, left
2SD 001 699-061	1	right
<hr/>		
Rear-stop-indicator light, with illumination for 340 x 240 mm and 240 x 130 mm licence plates, left		
2SE 001 699-071	1	left
Spare parts/Accessories:		
9EL 109 139-001	2	Lens with screws
9GT 074 132-001	10	Grommet
8GA 002 071-131	10	R10W bulb, 12V
8GA 002 071-251	10	R10W bulb, 24V
8GA 002 073-121	10	P21W bulb, 12V
8GA 002 073-241	10	P21W bulb, 24V

For horizontal surface mounting

Red rear and stop light, amber indicator light.
Black plastic body. With grommet.
Two M6 fixing screws.

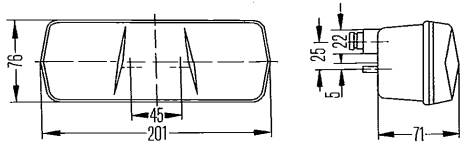

Part no.	Pk.	
2SD 001 680-271	1	Rear-stop-indicator light, left
2SD 001 680-281	1	right
2SD 001 680-391	1	Rear-stop-indicator light with PC-body, left
2SD 001 680-401	1	right
2SE 001 680-291	1	Rear-stop-indicator light with illumination for 520 x 120 mm, 340 x 240 mm and 240 x 130 mm licence plates, left
2SE 001 680-301	1	right
Spare parts/Accessories:		
9EL 107 368-001	2	left
9EL 111 647-001	2	right
8GA 002 071-131	10	R10W bulb, 12V
8GA 002 073-121	10	P21W bulb, 12V

For vertical surface mounting on towing vehicles and trailers

Cargoluna

Also permissible for trailers in combination with valid EC component homologation for lighting.
Red rear, stop light and reflector, amber indicator light, clear reverse light.
Black base plate. PC-lens.
With DEUTSCH plug, seal and bulbs.

Black base plate. PC-lens.
Four M6 x 25 fixing screws.
Water drain hole broken out.
Completely mounted.
Vertical attachment: direction indicator on inside.

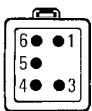
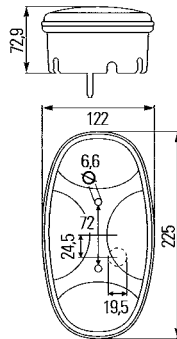

1	stop
3	rear
4	ground
5	reversing/rear fog
6	indicator

left

1	reverse
3	rear
4	ground
5	stop
6	indicator

right



Part no.	Pk.	
2VP 343 640-277	36	Rear-reflector-stop-indicator-reverse light with 12V bulbs, left
2VP 343 640-267	36	right
2VP 343 640-257	36	Rear-reflector-stop-indicator-reverse light with 24V bulbs, left
2VP 343 640-247	36	right
Spare parts:		
9EL 343 143-001	1	for -277/-257
9EL 343 142-001	1	for -267/-247
8GA 002 071-131	10	12V R10W bulb,
8GA 002 071-251	10	24V P21W bulb,
8GA 002 073-121	10	12V
8GA 002 073-241	10	24V

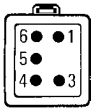
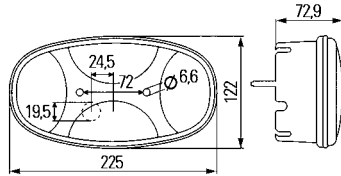

1	stop
3	rear
4	ground
5	reversing/rear fog
6	indicator
left	

1	reverse
3	rear
4	ground
5	stop
6	indicator
right	



For horizontal or vertical surface mounting on towing vehicles and trailers

Cargoluna

Also permissible for trailers in combination with valid EC component homologation for lighting. Red reflector, rear, stop and rear fog light, amber indicator light, clear reverse and licence plate light.

With grommet, DEUTSCH plug and bulbs.

Completely mounted.

Black base plate. PC-lens

Four M6 x 25 fixing screws.

Caution: The water drainage opening must be knocked out according to the attachment position!

Please refer to the installation instructions.

Horizontal attachment: direction indicator on top.

Vertical attachment: direction indicator on inside.

Part no.	Pk.	
2VP 343 640-051	1	Rear-reflector-stop-indicator-reverse light, 12V, left
2VP 343 640-057	36	
2VP 343 640-041	1	12V, right
2VP 343 640-047	36	
2VP 343 640-091	1	24V, left
2VP 343 640-097	36	
2VP 343 640-081	1	24V, right
2VP 343 640-087	36	
2VA 343 640-131	1	Rear-reflector-stop-indicator-rear fog light, 12V, left
2VA 343 640-137	36	
2VB 343 640-127	36	Rear-reflector-stop-indicator-rear fog licence plate light, 12V, left
2VB 343 640-297	36	
2VA 343 640-117	36	Rear-reflector-stop-indicator-rear fog light, 24V, left
2VA 343 640-207	36	
Spare parts/Accessories:		
9EL 343 143-001	1	Lens for -051/-057/-091/-097
9EL 343 143-011	1	for -117/-127/-131/-137/-297
9EL 343 142-001	1	for -041/-047/-081/-087
8GA 002 071-131	10	R10W bulb, 12V
8GA 002 071-251	10	24V
8GA 002 073-121	10	P21W bulb, 12V
8GA 002 073-241	10	24V

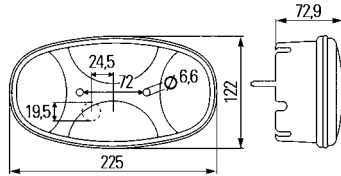

For horizontal or vertical surface mounting on towing vehicles and trailers

Cargoluna

Also permissible for trailers in combination with valid EC component homologation for lighting.

Red reflector, rear, stop and rear fog light, amber indicator light, clear reverse and licence plate illumination.

With grommet and seal, without bulbs.

Lights are not mounted.

Black base plate. PC-lens

Four M6 x 25 fixing screws.

Caution: The water drainage opening must be knocked out according to the attachment position!

Please refer to the installation instructions.

Horizontal attachment: direction indicator on top.

Vertical attachment: direction indicator on inside.



Part no.	Pk.	
2VB 343 640-011	1	Rear-reflector-stop-indicator-rear fog-licence plate light 12V/24V, left
2VB 343 640-017	72	
2VP 343 640-031	1	Rear-reflector-stop-indicator-rear fog-reverse light, 12V/24V, left
2VP 343 640-021	1	
2VP 343 640-027	72	12V/24V, right
2VA 343 640-071	1	Rear-reflector-stop-indicator-rear fog light, 12V/24V, left
2VA 343 640-077	72	
2VA 343 640-067	72	12V/24V, right
2VA 343 640-237	72	Rear-reflector-stop-indicator light, 12V/24V, left
2VA 343 640-101	1	
2VA 343 640-107	72	12V/24V, right
Spare parts/Accessories:		
Lens		
9EL 343 143-001	1	for -031/-037
9EL 343 143-011	1	for -017/-071/-077
9EL 343 142-001	1	for -021/-027
8GA 002 071-131	10	R10W bulb, 12V
8GA 002 071-251	10	24V
8GA 002 073-121	10	P21W bulb, 12V
8GA 002 073-241	10	24V



For horizontal surface mounting on towing vehicles

Also permissible for trailers in combination with valid EC component homologation for lighting.
Red reflector, rear, stop and rear fog light, amber indicator light, clear reversing light,
Black base plate.
Four 6 mm dia. holes for fixing screws.

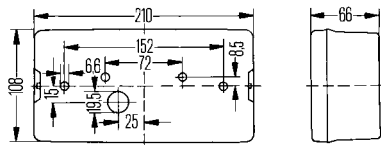

1	stop	stop
2	indicator	indicator
3	rear	rear
4	reversing/rear fog	reversing/rear fog
5	ground	black
6	-	not used



Part no.	Pk.	Description
2VB 006 040-051	1	Rear-reflector-stop-indicator-rear fog-licence plate light, with illumination for 520 x 120 mm and 340 x 240 mm licence plates, left
2VA 006 040-071	1	Rear-reflector-stop-indicator-rear fog light, left
2VA 006 040-077	10	
2VP 006 040-111	1	Rear-reflector-stop-indicator-reverse light, left
2VP 006 040-117	25	
2VP 006 040-121	1	right
2VP 006 040-127	25	
2VP 006 040-437	20	Rear-reflector-stop-indicator light with DEUTSCH plug and 1000 mm lead and 12V bulbs, without gasket left
2VP 006 040-447	20	right
2VP 006 040-397	20	Rear-reflector-stop-indicator light with DEUTSCH plug, 1000 mm lead, 24V bulbs and gasket, left
2VP 006 040-407	20	right
2VA 006 040-457	20	Rear-reflector-stop-indicator light with PC lens, with DEUTSCH plug, 1000 mm lead and 24V bulbs, without gasket, with rear fog light, left
2VP 006 040-467	20	with reversing light right
2VP 006 040-477	20	Rear-reflector-stop-indicator light with PC lens, with DEUTSCH plug, 1000 mm lead, 24V bulbs and gasket, left
2VP 006 040-487	20	right
9EL 136 833-011	1	Spare parts/Accessories: Lens, left, for -051
9EL 136 819-031	1	left, for -071/-077
9EL 136 825-001	1	left, for -111/-117/-397/-437
9EL 136 825-011	1	right, for -121/-127/-407/-447
9GD 102 484-001	10	Gasket for extreme loads R10W bulb,
8GA 002 071-131	10	12V
8GA 002 071-251	10	24V
8GA 002 073-121	10	P21W bulb, 12V
8GA 002 073-241	10	24V

For vertical surface mounting on towing vehicles

Also permissible for trailers in combination with valid EC component homologation for lighting.

Rear-reflector-stop-indicator-rear fog light, amber indicator light, clear reverse light.

Black base plate.

Four 6 mm dia. holes for fixing screws.

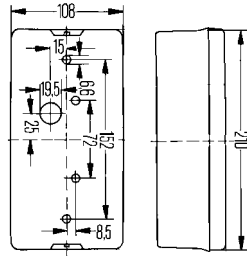

Part no.	Pk.	
2VA 006 040-291	1	Rear-reflector-stop-indicator-rear fog light, left
2VA 006 040-297	64	
2VP 006 040-351	1	Rear-reflector-stop-indicator-reverse light, left
2VP 006 040-357	64	
2VP 006 040-301	1	right
2VP 006 040-307	64	
Spare parts:		
9GD 102 484-001	10	Gasket for extreme loads
8GA 002 071-131	10	R10W bulb, 12V
8GA 002 071-251	10	24V P21W bulb,
8GA 002 073-121	10	12V
8GA 002 073-241	10	24V

For horizontal surface mounting on trailers

Red rear, stop and rear fog light, amber indicator light.

Black base plate.

Four 6 mm dia. holes for fixing screws.

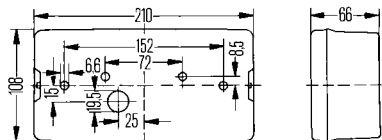

Part no.	Pk.	
2SE 006 040-011	1	Rear-stop-indicator-rear fog-licence plate light, with illumination for 520 x 120 mm and 340 x 240 mm licence plates left
2SD 006 040-031	1	Rear-stop-indicator-rear fog light, left
2SD 006 040-037	10	
2SD 006 040-041	1	right
2SD 006 040-161	1	Rear-stop-indicator light, right
2SD 006 040-167	10	
Spare parts/Accessories:		
9EL 136 833-001	1	Lens, left, for -011
9EL 136 819-011	1	left, for -031/-037
9EL 137 792-011	1	right, for -041
9EL 137 792-011	1	right, for -161/-171
9GD 102 484-001	10	Gasket for extreme loads
8GA 002 071-131	10	R10W bulb, 12V
8GA 002 071-251	10	24V P21W bulb,
8GA 002 073-121	10	12V
8GA 002 073-241	10	24V

For vertical surface mounting on trailers

**Red rear, stop and rear fog light,
amber indicator light**

Black base plate.

Four 6 mm dia. holes for fixing screws.

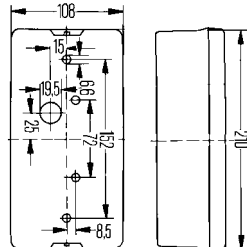

Part no.	Pk.	
2SD 006 040-131	1	Rear-stop-indicator-rear fog light, left
2SD 006 040-137	10	
2SD 006 040-331	1	Rear-stop-indicator light, left
2SD 006 040-337	64	
2SD 006 040-141	1	right
2SD 006 040-147	10	
Spare parts/Accessories:		
9EL 136 819-041	1	Lens, left
9EL 137 792-031	1	right
9GD 102 484-001	10	Gasket for extreme loads R10W bulb,
8GA 002 071-131	10	12V
8GA 002 071-251	10	24V
		P21W bulb,
8GA 002 073-121	10	12V
8GA 002 073-241	10	24V

For horizontal or vertical (indicator light above) surface mounting

Red rear, stop and rear fog light, amber indicator light, with illumination for 520 x 120 mm and 340 x 240 mm licence plates.

Black base plate, with grommet. Two M6 fixing screws.

Distance between screws 72 mm or 152 mm.

Licence plate opening can be replaced

with red lens included loose

(for use as rear-stop-indicator light).

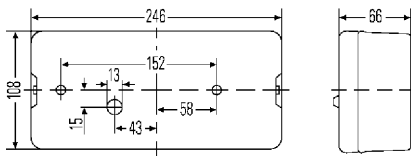
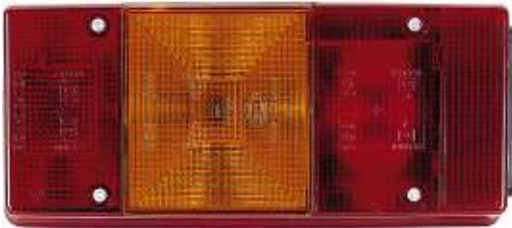

Part no.	Pk.	
2SE 007 547-011	1	Rear-stop-indicator-rear fog-licence plate light, left
2SE 007 547-017	30	
2SE 007 547-021	1	right
2SE 007 547-027	25	
2VB 007 547-171	1	Rear-reflector-stop-indicator-rear fog-licence plate light, left
2SE 007 547-041	1	Rear-stop-indicator-licence plate light, right
		Spare parts/Accessories:
		Lens with licence plate window and red lens
9EL 147 096-001	1	for -011/-017/-021/-027/-041
9EL 147 096-031	1	for -171
8GA 002 071-131	10	R10W bulb, 12V
8GD 002 078-121	10	P21/5W bulb, 12V
8GA 002 073-121	10	P21W bulb, 12V
2SL 007 547-061	1	Rear-stop-indicator-reverse-licence plate light, right
2SL 007 547-067	30	
2VD 007 547-181	1	Rear-reflector-stop-indicator-licence plate light, right
		Spare parts/Accessories:
		Lens with licence plate window and red lens
		for -061/-067
9EL 147 097-001	1	for -181
9EL 147 096-021	1	R10W bulb, 12V
8GA 002 071-131	1	P21/5W bulb, 12V
8GD 002 078-121	1	P21W bulb, 12V
8GA 002 073-121	1	



For horizontal or vertical flush/surface mounting

Red rear and stop light, amber indicator light, clear licence plate light.

Black plastic body.
Two M8 fixing screws.

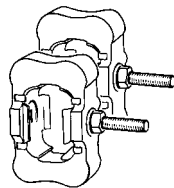
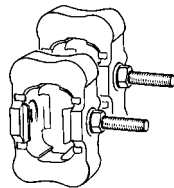
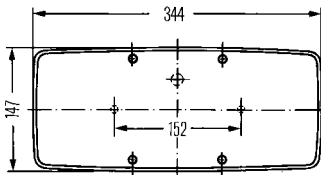

Part no.	Pk.	
2SD 003 167-011	1	Rear-stop-indicator light, left
2SD 003 167-021	1	right
2SD 003 167-531	1	Rear-stop-indicator light with PC body, left
2SD 003 167-541	1	right
2SE 003 167-031	1	Rear-stop-indicator light, with illumination for 520 x 120 mm and 340 x 240 mm licence plates, for horizontal surface mounting, left
2SE 003 167-041	1	right
Spare parts/Accessories:		
9EL 147 747-001	1	Lens with screws
9EL 147 747-007	306	
9GD 087 883-355	10	Gasket
9GP 003 995-801	1	External vibration dampers
8GA 002 073-121	10	Kit comprising: 2 each with M8 fixing screw
8GA 002 073-241	10	P21W bulb, 12V
8GA 002 071-131	10	24V
8GA 002 071-251	10	R10W bulb, 12V
	10	24V
2SD 003 167-521	3	Rear-stop-indicator light for double-filament bulb in stop-light section for additional rear-light function for horizontal surface mounting, right (only for spare parts requirement)
Spare parts/Accessories:		
9GD 087 883-355	10	Gasket
9GD 118 983-021	10	Body gasket for flush mounting
9GP 003 995-801	1	External vibration dampers
8GA 002 071-121	10	Kit comprising: 2 each with M8 fixing screw
8GA 002 071-251	10	12V
8GA 002 073-121	10	24V
8GA 002 073-241	10	P21W bulb, 12V
8GD 002 078-121	10	24V
8GD 002 078-241	10	P21/5W bulb, 12V
8GD 002 078-011	10	24V (HD)

For horizontal flush mounting

Red rear, stop and rear fog light, amber indicator light, white reverse light.

Four B4.8 x 25 x 15 fixing screws.

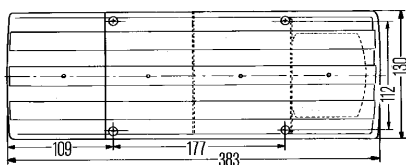

Part no.	Pk.	
2SD 004 460-001	1	Rear-stop-indicator-rear fog light with 12V bulb
2SD 004 460-007	16	
2SD 004 460-011	1	Rear-stop-indicator light with 12V bulbs
2SD 004 460-017	16	
2SB 004 460-061	1	Rear-stop-rear fog light without bulbs
8GA 002 071-131	10	Spare parts/Accessories: R10W bulb, 12V
8GA 002 073-121	10	
2SK 004 460-031	1	Rear-stop-indicator-rear fog-reverse light with 12 bulbs
2SK 004 460-037	16	
2SK 004 460-041	1	Rear-stop-indicator-reverse light with 12 bulbs
8GD 002 078-121	10	Spare parts: P21/5W bulb, 12V
8GA 002 073-121	10	

Red rear, stop and rear fog light, amber indicator light, white reverse light. With 12 bulbs.

With four fixing screws.

Two lights can be fitted next to each other.

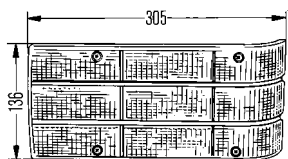

Part no.	Pk.	
2SD 006 459-021	1	Rear-stop-indicator light
2SD 006 459-027	18	
2SD 006 459-031	1	Rear-stop-indicator-rear fog light
2SK 006 459-041	1	Rear-stop-indicator-reverse light
8GD 002 078-121	10	Spare parts: P21/5W bulb, 12V
8GA 002 073-121	10	

For vertical flush mounting

Caraluna Modular

For caravan-trailers and mobile homes.
 Red rear, stop, rear fog and side marker light, clear indicator light (with amber bulb), and clear reverse light.

With seal. Four fitting screws ST4,8.

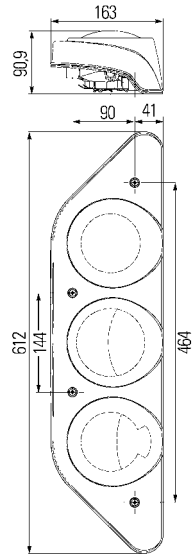

Part no.	Pk.	
2VP 343 520-017	18	Rear-stop-indicator-rear fog-reverse-side-marker light with reflektor, with 12V bulbs, left
2VP 343 520-027	18	with 12V bulbs, right
2VP 343 520-037	18	with 24V bulbs, left
2VP 343 520-047	18	with 24V bulbs, right
<hr/>		
2VP 343 520-057	18	Rear-stop-indicator-rear fog-reverse-side-marker light with reflector, chrome-plating applied in the body shimmers through the lens, with 12V bulbs, left
2VP 343 520-067	18	right
Spare parts/Accessories:		
8GA 002 073-121	10	12V
8GA 002 073-241	10	24V
		R10W bulb,
8GA 002 071-131	10	12V
8GA 002 071-251	10	24V
		PY21W bulb,
8GA 006 841-121	10	12V
8GA 006 841-241	10	24V
8RA 344 065-007	144	Reflector, red, self-adhesive

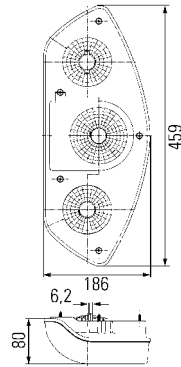

For vertical flush mounting

Caraluna Vertical

For caravan-trailers and mobile homes.
 Red rear, stop, rear fog light,
 clear indicator light (with amber bulb)
 and clear reverse light.
 With 12V bulbs.
 Two fitting screws ST4,8.

Part no.	Pk.	
2SD 343 440-017	10	Rear-stop-indicator-rear fog light, left
2SK 343 440-027	10	Rear-stop-indicator-reverse light, right
2SD 343 440-057	10	Rear-stop-indicator-rear fog light with smoke coloured lens, left
2SK 343 440-067	10	Rear-stop-indicator-reverse light with smoke coloured lens, right
2SK 343 440-037	10	Rear-stop-indicator-reverse light, left
2SD 343 440-047	10	Rear-stop-indicator-rear fog light, right
Spare parts:		
8GA 002 073-121	10	P21W bulb, 12V
8GD 002 078-121	10	P21/5W bulb, 12V
8GA 006 841-121	10	PY21W bulb, 12V

For horizontal flush mounting

Caraluna I

For caravan-trailers. With triangular reflector.
 For mobile homes. With rectangular reflector.
 Red reflector, rear, stop, rear fog light,
 and side-marker light with reflector,
 clear indicator light and white reverse light.
 With 12V bulbs.

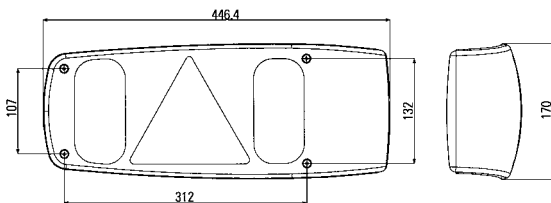

Part no.	Pk.	
2VA 007 502-011	1	Rear-reflector-stop-indicator-rear fog light-side-marker light with reflector, left
2VA 007 502-017	12	
2VA 007 502-061	1	right
2VA 007 502-067	12	
2VP 007 502-031	1	Rear-reflector-stop-indicator-reverse-side-marker light with reflector, left
2VP 007 502-037	12	
2VP 007 502-041	1	right
2VP 007 502-047	12	
Spare parts:		
8GD 002 078-121	10	P21/5W bulb, 12V
8GA 006 841-121	10	PY21W bulb, 12V
8GA 002 073-121	10	P21W bulb, 12V
<hr/>		
2VA 007 502-021	1	Rear-reflector-stop-indicator-side-marker light with reflector with triangular reflector. right
2VA 007 502-027	12	
Spare parts:		
8GD 002 078-121	10	P21/5W bulb, 12V
8GA 006 841-121	10	PY21W bulb, 12V
<hr/>		
2VA 007 502-111	1	Rear-reflector-stop-indicator-rear fog-side-marker light with reflector, left
2VA 007 502-117	12	
2VP 007 502-121	1	Rear-reflector-stop-indicator-reverse-side-marker light with reflector, right
2VP 007 502-127	12	
Spare parts:		
8GD 002 078-121	10	P21/5W bulb, 12V
8GA 006 841-121	10	PY21W bulb, 12V
8GA 002 073-121	10	P21W bulb, 12V

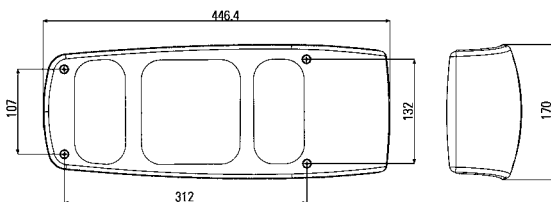

For horizontal flush mounting

Caraluna II

For caravan-trailers. With triangular reflector.
 For mobile homes. With round reflector.
 Red reflector, rear, stop, rear fog light
 and side-marker reflector,
 clear indicator light (amber bulb), clear reverse light.
 With red lens and 12V bulbs.

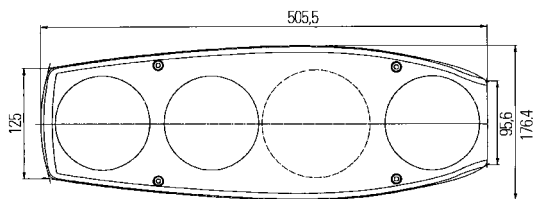
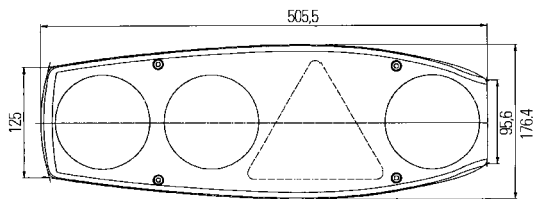

Part no.	Pk.		
2VA 341 419-011	1	Rear-stop-triangular reflector-indicator-rear fog and side-marker light, left	
2VA 341 419-017	10		
2VA 341 419-061	1	right	
2VA 341 419-067	10		
2VA 341 419-021	1	Rear-triangular reflector-stop-indicator-side-marker light, right	
2VA 341 419-027	10		
2VP 341 419-031	1	Rear-stop-triangular reflector-indicator-reverse-side-marker light, left	
2VP 341 419-037	10		
2VP 341 419-041	1	right	
2VP 341 419-047	10		
2VA 341 419-111	1	Rear-stop-indicator-rear fog-side-marker light with reflector, left	
2VA 341 419-117	10		
2VA 341 419-147	1	right	
2VP 341 419-137	1	Rear-stop-indicator-rear fog-reverse-side-marker light with reflector, left	
2VP 341 419-121	1		
2VP 341 419-127	10	right	
8GD 002 078-121	10	Spare parts:	
8GA 006 841-121	10		P21/5W bulb, 12V
8GA 002 073-121	10		PY21W bulb, 12V

For horizontal flush mounting

Caraluna II

For caravan-trailers. With triangular reflector.

For mobile homes. With round reflector.

Red reflector, rear, stop, rear fog light and side-marker reflector, clear indicator light (amber bulb), clear reverse light.

With smoke coloured lens and 12V bulbs.

Chrome-plating applied in the body shimmers through the lens.

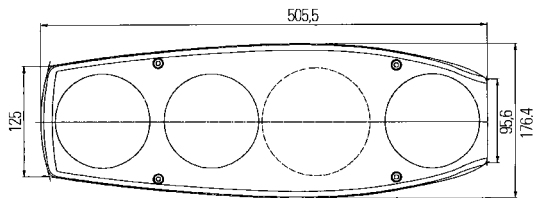
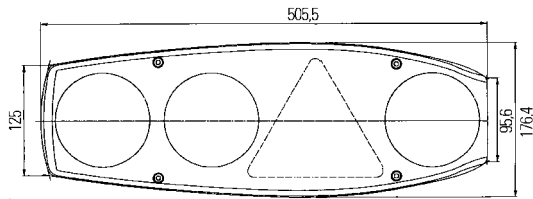

Part no.	Pk.	
2VA 341 419-097	10	Rear-triangular reflector-stop-indicator-rear fog light, left
2VA 341 419-167	10	right
2VP 341 419-157	10	Rear-triangular reflector-stop-indicator-reverse light, left
2VP 341 419-107	10	right
2VA 341 419-077	10	Rear-reflector-stop-indicator-rear fog light, left
2VA 341 419-187	10	right
2VP 341 419-177	10	Rear-reflector-stop-indicator-reverse light, left
2VP 341 419-087	10	right
Spare parts:		
8GD 002 078-121	10	P21/5W bulb, 12V
8GA 006 841-121	10	PY21W bulb, 12V
8GA 002 073-121	10	P21W bulb, 12V

For horizontal flush mounting

Caraluna II Plus

For caravan-trailers. With triangular reflector.
 For mobile homes. With round reflector.
 Red reflector rear, stop, rear fog light
 and side-marker light with reflector,
 clear indicator light (amber bulb), clear reverse light.
 With red lens and 12V bulbs.

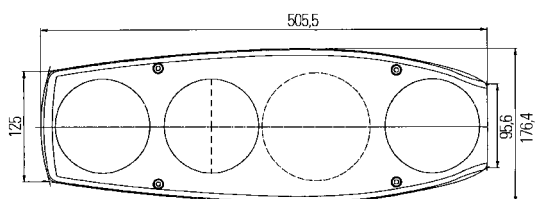
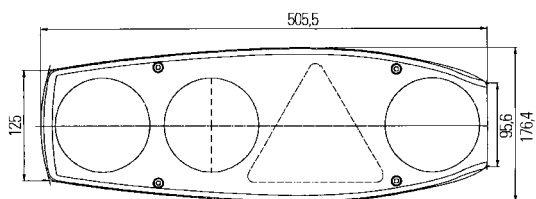

Part no.	Pk.	
2VP 343 590-017	10	Rear-stop-indicator-rear fog-reverse-side-marker light with reflector, left
2VP 343 590-027	10	right
<hr/>		
2VP 343 590-037	10	Rear-reflector-stop-indicator-rear fog-reverse-side-marker light with reflector, left
2VP 343 590-047	10	right
Spare parts:		
8GD 002 078-121	10	P21/5W bulb, 12V
8GA 006 841-121	10	PY21W bulb, 12V
8GA 002 073-121	10	P21W bulb, 12V

For horizontal flush mounting

Caraluna II Plus

For caravan-trailers. With triangular reflector.
 For mobile homes. With round reflector.
 Red reflector, rear, stop and rear fog light,
 clear indicator light (amber bulb), clear reverse light.
 With smoke coloured lens and 12V bulbs.
 Chrome-plating applied in the body
 shimmers through the lens.

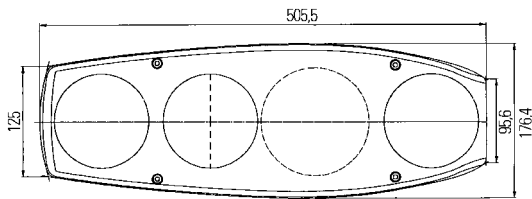
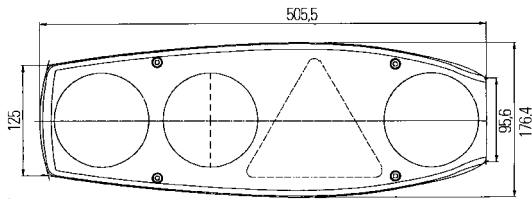

Part no.	Pk.	
2VP 343 590-057	10	Rear-reflector-stop-indicator-rear fog-reverse light, left
2VP 343 590-067	10	right
2VP 343 590-077	10	Rear-reflector-stop-indicator-rear fog-reverse light, left
2VP 343 590-087	10	right
Spare parts:		
8GD 002 078-121	10	P21/5W bulb, 12V
8GA 006 841-121	10	PY21W bulb, 12V
8GA 002 073-121	10	P21W bulb, 12V

For horizontal or vertical flush mounting

Red rear and stop light, amber indicator light.
 With grommet.

B4.2 x 13 self-tapping fixing screws.
 Only for spare parts requirement.

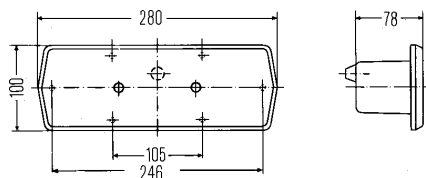

Part no.	Pk.	
2SD 001 693-011	1	Rear-stop-indicator light
Spare parts/Accessories:		
9GT 074 132-001	10	Grommet
8GA 002 071-131	10	R10W bulb, 12V
8GA 002 071-251	10	24V P21W bulb,
8GA 002 073-121	10	12V
8GA 002 073-241	10	24V

For horizontal surface mounting

Red rear and stop light, amber indicator light.

Lens with snap fastening. Red plexiglass frame.
Four 5.5 mm dia. holes for fixing screws.
Only for spare parts requirement.

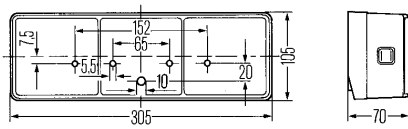

Part no.	Pk.	
2SE 003 409-191	1	Rear-stop-indicator light with illumination for 520 x 120 mm and 340 x 240 mm licence plates, with black base plate, left
2SE 003 409-197	5	
2SD 003 409-201	1	Rear-stop-indicator light with black base plate, right
2SD 003 409-207	5	
Spare parts:		
		Lens,
9EL 121 260-051	1	left
9EL 121 260-061	1	right
8GA 002 071-121	10	R5W bulb, 12V
8GA 002 071-131	10	R10W bulb, 12V
8GA 002 073-121	10	P21W bulb, 12V
<hr/>		
2SD 003 409-317	1	Rear-stop-indicator-rear fog light with grey base plate, left
2SD 003 409-327	18	with grey base plate, right
Spare parts:		
8GD 002 078-121	10	P21/5W bulb, 12V
8GA 002 073-121	10	P21W bulb, 12V
<hr/>		
2SE 003 409-171	1	Rear-stop-indicator-rear fog light with illumination for 520 x 120 mm and 340 x 240 mm licence plates, with black base plate, left
2SD 003 409-181	1	Rear-stop-indicator light, with black base plate, right
Spare parts:		
8GD 002 078-121	10	P21/5W bulb, 12V
8GA 002 073-121	10	P21W bulb, 12V
8GA 002 071-131	10	R10W bulb, 12V

For horizontal flush/surface mounting

Red rear, reflector and stop light, amber indicator light.

Black plastic body. Two M6 fixing screws.
With plug connector.

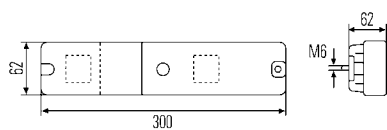

Part no.	Pk.	
2VA 997 113-001	1	Rear-reflector-stop-indicator light
Spare parts:		
9EL 997 453-001	2	Lens
8GA 002 073-121	10	P21W bulb, 12V
8GA 002 073-241	10	24V
8GD 002 078-121	10	P21/5W bulb, 12V
8GD 002 078-241	10	24V
8GD 002 078-011	10	24V (Heavy Duty)

For horizontal flush/surface mounting

Red rear and stop light, amber indicator light.

Lens with snap fastening.
Two 5.5 mm dia. holes for fixing screws.

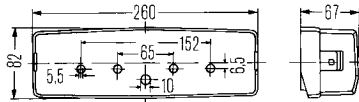

Part no.	Pk.	
2SD 002 844-031	1	Rear-stop-indicator light with white base plate, left
2SD 002 844-021	1	with white base plate, right
2SD 002 844-131	1	with black base plate, left
2SD 002 844-061	1	with black base plate, right
2SD 002 844-067	18	
Spare parts:		
	2	Lens, left
	2	right
	10	C5W bulb, 12V
	10	P21W bulb, 12V
<hr/>		
2SE 002 844-011	1	Rear-stop-indicator light with illumination for 340 x 240 mm licence plates, with white base plate, left
2SE 002 844-051	1	with black base plate, left
Spare parts:		
	2	Lens, left
	10	C5W bulb, 12V
	10	P21W bulb, 12V

For horizontal surface mounting

Red rear, stop, rear fog light and triangular reflector, white indicator light (amber bulb) and licence plate light.

With fixing material and grommet, without lead.

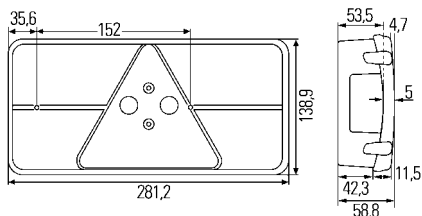

Part no.	Pk.	
2VB 341 032-111	1	Rear-reflector-stop-indicator-rear fog-licence plate light, left
2VB 341 032-117	10	
2VB 341 032-141	1	right
<hr/>		
2VB 341 032-121	1	Rear-reflector-stop-licence plate light, right
2VB 341 032-127	10	
Spare parts:		
	10	P21/5W bulb, 12V
	10	P21W bulb, 12V
	10	PY21W bulb, 12V
	10	C5W bulb, 12V

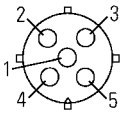
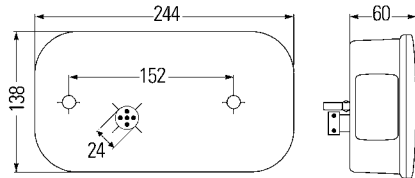

1	ground	white
2	indicator	green/yellow
3	stop	red
4	rear/licence plate/marker	black
5	rear fog or reverse	blue/free

For horizontal surface mounting

Red rear, stop, rear fog light and triangular reflector, amber indicator light and side marker light.

White licence plate light.

With 5-pole central plug and 12V bulbs.

Black plastic body.

Two M6 fixing screws.

Part no.	Pk.	
2VB 998 232-011	1	Rear-triangular reflector-stop-indicator-rear fog light with illumination for 520 x 120 mm licence plates, left
2VB 998 232-021	1	Rear-triangular reflector-stop-indicator light with illumination for 520 x 120 mm licence plates, right
2VB 998 232-057	36	Rear-triangular reflector-stop-indicator-side-marker light with illumination for 520 x 120 mm licence plates, left
Spare parts:		
9EL 990 632-001	1	Lens
8GD 002 078-121	10	P21/5W bulb, 12V
8GA 002 073-121	10	P21W bulb, 12V
8GM 002 092-121	10	C5W bulb, 12V

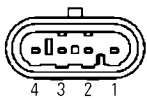
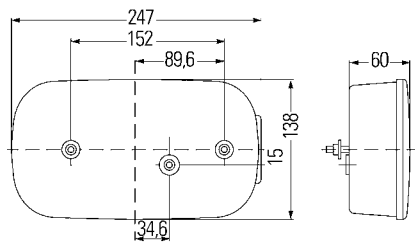

1	ground	white
2	stop	red
3	rear	brown
4	indicator	green

For horizontal surface mounting on towing vehicles

Red rear, stop light and triangular reflector, indicator light (amber bulb) and clear licence plate light, amber side marker light.

With 4-pole AMP plug connector, 200 mm lead and bulbs 12V.

Black plastic body.

Two M6 fixing screws.

Part no.	Pk.	
2VB 998 232-537	36	Rear-reflector-stop-indicator-side marker light, with licence plate illumination, left
2VA 998 232-547	36	without licence plate illumination, right
Spare parts:		
9EL 990 632-041	1	Lens
8GD 002 078-121	10	P21/5W bulb, 12V
8GA 002 073-121	10	P21W bulb, 12V
8GA 006 841-121	10	PY21W bulb, 12V
8GM 002 092-121	10	C5W bulb, 12V

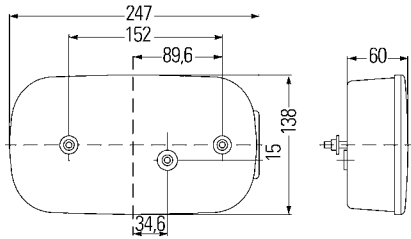

For horizontal surface mounting

Red rear, stop, rear fog light and triangular reflector, amber indicator light and side marker light.

White licence plate light.

With grommet, without bulbs and 5-pole central plug.

Black plastic body.

Two M6 fixing screws.

Part no.	Pk.	
2VB 998 232-211	1	Rear-triangular reflector-stop-indicator-rear fog-licence plate light, for 520 x 120 mm licence plates, left
2VB 998 232-221	1	Rear-triangular reflector-stop-indicator-licence plate light, for 520 x 120 mm licence plates, right
Spare parts:		
9EL 990 632-001	1	Lens
8GD 002 078-121	10	P21/5W bulb, 12V
8GA 002 073-121	10	P21W bulb, 12V
8GM 002 092-121	10	C5W bulb, 12V

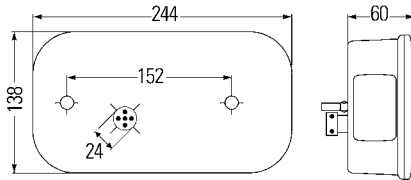

Red rear, stop, rear fog light and triangular reflector, reverse light and indicator light white (amber bulb), amber side marker light.

With 5-pole central plug and 12V bulbs.

Black plastic body.

Two M6 fixing screws.

Part no.	Pk.	
2VB 998 232-131	1	Rear-triangular reflector-stop-indicator-rear fog-licence plate light, for 520 x 120 mm licence plates, left
2VB 998 232-101	1	Rear-triangular reflector-stop-indicator-licence plate light, for 520 x 120 mm licence plates, right
2VB 998 232-171	1	Rear-triangular reflector-stop-indicator-rear fog-side-marker-licence plate light, for 520 x 120 mm licence plates, left
2VB 998 232-201	1	Rear-triangular reflector-stop-indicator-side-marker-licence plate light, for 520 x 120 mm licence plates, right
Spare parts/Accessories:		
9EL 990 632-011	1	Lens
8GD 002 078-121	10	P21/5W bulb, 12V
8GA 002 073-121	10	P21W bulb, 12V
8GA 006 841-121	10	PY21W bulb, 12V
8GM 002 092-121	10	C5W bulb, 12V

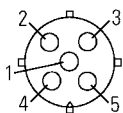

1	ground	white
2	indicator	green/yellow
3	stop	red
4	rear/licence plate/marker	brown/black
5	rear fog or reverse	blue/free

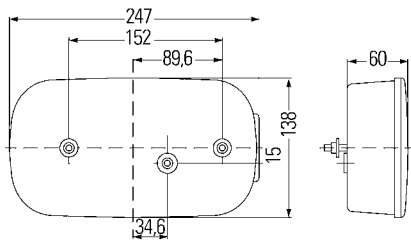

For horizontal flush/surface mounting

Red rear, stop, rear fog light and triangular reflector, reverse light and indicator light white (amber bulb), amber side marker light.

Black plastic body.

With two M6 fixing screws and grommet.

Part no.	Pk.	
2VB 998 232-231	1	Rear-triangular reflector-stop-indicator-rear fog-licence plate light, for 520 x 120 mm licence plates, for horizontal flush/surface mounting, without bulbs, left
2VB 998 232-241	1	Rear-triangular reflector-stop-indicator-licence plate light, for 520 x 120 mm licence plates, for horizontal flush/surface mounting, without bulbs, right
2VA 998 232-251	1	Rear-triangular reflector-stop-indicator-rear fog light for horizontal flush/surface mounting, with bulbs 12V, left
2VP 998 232-261	1	Rear-triangular reflector-stop-indicator-reverse light for horizontal flush/surface mounting, with bulbs 12V, right
2VA 998 232-291	1	Rear-triangular reflector-stop-indicator-rear fog-side-marker light for horizontal flush/surface mounting, with 12V bulbs, left
2VP 998 232-301	1	Rear-triangular reflector-stop-indicator-reverse-side-marker light for horizontal flush/surface mounting, with 12V bulbs, right
		Spare parts:
9EL 990 632-011	1	Lens
8GD 002 078-121	10	P21/5W bulb, 12V
8GA 002 073-121	10	P21W bulb, 12V
8GA 006 841-121	10	PY21W bulb, 12V
8GM 002 092-121	10	C5W bulb, 12V



For vertical flush mounting

Red rear, stop, rear fog light and triangular reflector, amber indicator light.

With 5-pole central plug and 12V bulbs.

Black plastic body.

With two M8 fixing screws.

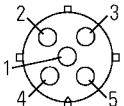
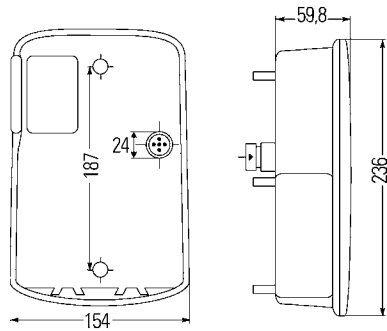

1	ground	white
2	indicator	green/yellow
3	stop	red
4	rear	brown/black
5	rear fog	blue/free

Part no.	Pk.	
2VA 998 233-367	36	Rear-triangular reflector-stop-indicator-rear fog light, right
2VA 998 233-357	36	Rear-triangular reflector-stop-indicator-rear fog light, with 200 mm lead, left
Spare parts/Accessories:		
		Lens,
9EL 990 633-011	1	left
9EL 990 633-021	1	right
8GA 002 073-121	10	P21W bulb, 12V
8GM 002 092-121	10	C5W bulb, 12V



Red rear, stop, rear fog light and triangular reflector, white indicator light (amber bulb), reverse light and position light, amber side marker reflector.

With 5-pole central plug and 12V bulbs.

Black plastic body.

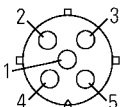
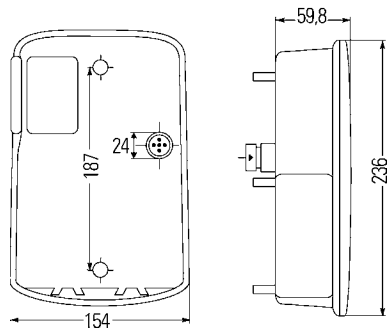

1	ground	white
2	indicator	green/amber
3	stop	red
4	rear/licence plate/marker	brown/black
5	rear fog or reverse	blue/free

Part no.	Pk.	
2VA 998 233-171	1	Rear-triangular reflector- stop-indicator-rear fog light with side marker reflector and position light, with two M8 fixing screws and quick mounting plate, left
2VA 998 233-271	1	Rear-triangular reflector- stop-indicator-rear fog light with side marker reflector and position light, with two M6 fixing screws, without quick mounting plate, left
2VP 998 233-281	1	Rear-triangular reflector-stop-indicator-reverse light with side marker reflector and position light, with two M6 fixing screws, without quick mounting plate, right
Spare parts:		
		Lens,
9EL 990 633-031	1	left
9EL 990 633-041	1	right
8GA 002 073-121	10	P21W bulb, 12V
8GA 006 841-121	10	PY21W bulb, 12V
8GM 002 092-121	10	C5W bulb, 12V

For horizontal or vertical surface mounting on Fork-lift

LeanLED

In LED-technology. Clear lens. With 24 LEDs.
Rearlight: 1.0W, stoplight: 1.5W, indicator light: 2.0W.
 Black plastic body.
 Two 3.0 mm dia. holes for fixing screws.
 Voltage range: 9V - 31V.
 Consumption: 0.38A at 12V, 0.19A at 24V.
 See LED instruction 1.

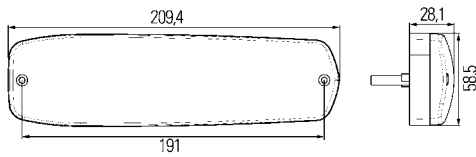

Part no.	Pk.	
2SD 343 910-001	1	Rear-stop-indicator light with 500 mm lead
2SD 343 910-007	48	
2SD 343 910-017	48	with 200 mm lead and 4-pole AMP-Superseal plug connector
2SD 343 910-027	48	without lead, with 4-pole AMP-Superseal plug
8KW 744 808-801	1	Accessories: 4-pole Superseal set, for -017/-027

For horizontal surface mounting

Red reflector, rear and stop light, amber indicator light

Lens with snap fastening.
 Two holes for M5 fixing screws. With plug connector.

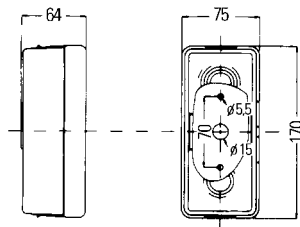

Part no.	Pk.	
2VA 998 531-031	1	Rear-reflector-stop-indicator light
9EL 997 310-001	1	Spare parts/Accessories: Lens
8GA 002 073-121	10	P21W bulb, 12V
8GA 002 073-241	10	24V
8GD 002 078-121	10	P21/5W bulb, 12V
8GD 002 078-241	10	24V

For horizontal or vertical surface mounting

Red rear and stop light, amber indicator light.

PC lens with snap fastening.
 Two holes for M5 fixing screws. With plug connector.

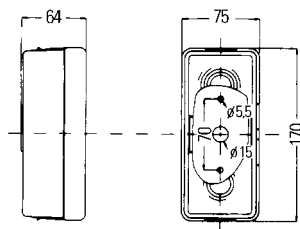

Part no.	Pk.	
2SD 998 531-057	1	Rear-stop-indicator light, left
2SD 998 531-067	1	right
9EL 998 001-031	2	Spare parts/Accessories: Lens, left
9EL 998 001-041	2	right
8GA 002 073-121	10	P21W bulb, 12V
8GA 002 073-241	10	24V
8GA 002 071-131	10	R10W bulb, 12V
8GA 002 071-241	10	24V

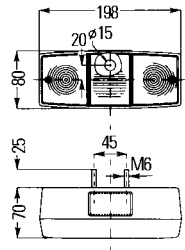

For horizontal flush/surface mounting

Red rear and stop light, amber indicator light, white licence plate light.

Black plastic body.
Bulb holder with vibration damping.
Two M6 fixing screws. With grommet.

Part no.	Pk.	
2SE 997 005-011	1	Rear-stop-indicator-licence plate light, left
2SD 997 005-021	1	Rear-stop-indicator light, right
Spare parts/Accessories:		
9EL 997 313-001	2	Lens with screws
8GA 002 071-121	10	12V
8GA 002 071-241	10	24V
		P21W bulb,
8GA 002 073-121	10	12V
8GA 002 073-241	10	24V

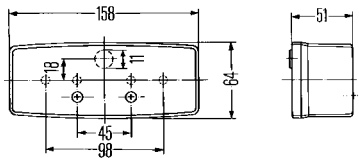

For horizontal or vertical surface mounting

Red rear and stop light, amber indicator light, white licence plate light.

Plastic body. Four holes for M5 fixing screws. With grommet.
Exchangeable lens insert for
licence plate lighting / no licence plate lighting.

Part no.	Pk.	
2SE 997 111-011	1	Rear-stop-indicator-licence plate light, left
2SE 997 111-021	1	right
Spare parts/Accessories:		
		Lens with screws and red lens insert,
9EL 997 451-001	1	left
9EL 997 452-001	1	right
		R10W bulb,
8GA 002 071-131	10	12V
8GA 002 071-251	10	24V
		P21W bulb,
8GA 002 073-121	10	12V
8GA 002 073-241	10	24V



For horizontal surface mounting

Red rear and stoplight, amber indicator light, clear licence plate light.

Black plastic body.
For Deutz-Fahr.
National type test for Germany.

Part no.	Pk.	
2SE 001 306-051	2	Rear-stop-indicator-licence plate light, left
2SD 001 306-061	2	Rear-stop-indicator light, right
Spare parts/Accessories:		
		Lens with screws,
9EL 104 571-031	1	left
9EL 104 571-041	1	right
8GM 002 092-121	10	C5W bulb, 12V
8GM 002 091-121	10	K bulb, 12V

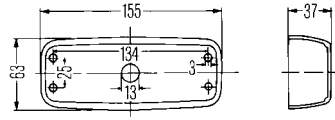

For horizontal or vertical surface mounting

Red rear and stop light, amber indicator light.

Four holes 3 mm dia. for fixing screws.
National type test for Germany.

Part no.	Pk.	
2SD 001 305-021	1	Rear-stop-indicator light
Spare parts/Accessories:		
9EL 052 476-001	1	Lens with screws C5W bulb,
8GM 002 092-121	10	12V
8GM 002 092-241	10	24V
8GM 002 091-121	10	K bulb, 12V
8GM 002 091-241	10	24V

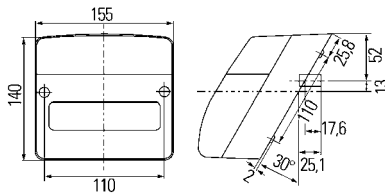

For horizontal surface mounting

Red reflector, rear and stop light, amber indicator light, white licence plate light.
With 12V bulbs.

With plug connector and 4 PT screws KB 40 x 20.

Part no.	Pk.	
2SE 996 030-011	1	Rear-reflector-stop-indicator-licence plate light, left
2SD 996 030-021	1	Rear-reflector-stop-indicator light, right
Spare parts:		
9EL 990 142-001	1	Lens incl. black cover and licence plate window
8GA 002 071-121	10	R5W bulb, 12V
8GA 002 073-121	10	P21W bulb, 12V

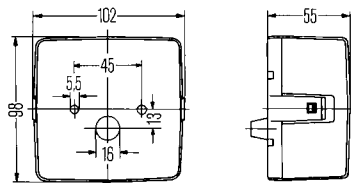

For horizontal or vertical surface mounting

Red rear and stop light, amber indicator light, clear licence plate light.

Lens with snap fastening.
Two holes for M5 fixing screws. With grommet.
Lens for illumination of licence plate can be replaced with red lens included (for use as rear-stop-indicator-light).

Part no.	Pk.	
2SD 004 623-028	1000	Rear-stop-indicator light
2SE 004 623-001	1	Rear-stop-indicator-licence plate light, for 520 x 120 mm, 340 x 240 mm and 240 x 130 mm licence plates (above licence plates)
2SE 004 623-007	50	
Spare parts/Accessories:		
9EL 129 519-001	1	Lens
8GA 002 071-131	10	R10W bulb, 12V
8GA 002 073-121	10	P21W bulb, 12V

For horizontal surface mounting

Red rear and stop light, amber indicator light, clear licence plate light.

Two holes for M6 fixing screws. With grommet.
Lens for illumination of licence plate can be replaced with red lens included (for use as rear-stop-indicator light).

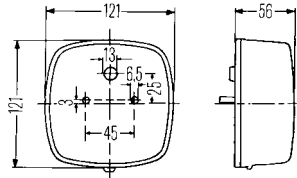

Part no.	Pk.	
2SE 002 578-701	2	Rear-stop-indicator-licence plate light
2SE 002 578-707	18	
Spare parts/Accessories:		
9EL 146 491-001	2	Lens (also suitable for old-type lights of model range 002 578-...) R10W bulb,
8GA 002 071-131	10	12V
8GA 002 071-251	10	24V
8GA 002 073-121	10	P21W bulb,
8GA 002 073-241	10	12V
		24V

Red rear and stop light, amber indicator light, clear licence plate light.

Steel base plate.
Two M6 fixing screws. With plug connector.
Lens for illumination of licence plate can be replaced with red lens included (for use as rear-stop-indicator light).

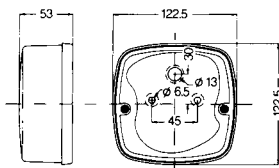

Part no.	Pk.	
2SE 997 008-001	1	Rear-stop-indicator- licence plate light
Spare parts/Accessories:		
9EL 997 332-001	1	Lens
		R10W bulb,
8GA 002 071-131	10	12V
8GA 002 071-251	10	24V
		P21W bulb,
8GA 002 073-121	10	12V
8GA 002 073-241	10	24V

Red rear and stop light, amber indicator light, clear licence plate light.

Black plastic body.
Two M6 fixing screws. With grommet.

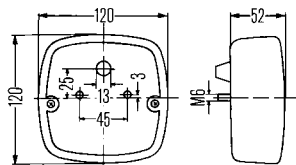

Part no.	Pk.	
2SD 002 514-161	1	Rear-stop-indicator light
		Rear-stop-indicator-licence plate light, for 520 x 120 mm, 340 x 240 mm and 240 x 130 mm licence plates
2SE 002 514-171	1	
Spare parts/Accessories:		
9EL 119 614-031	2	Lens with screws
		R10W bulb,
8GA 002 071-131	10	12V
8GA 002 071-251	10	24V
		P21W bulb,
8GA 002 071-121	10	12V
8GA 002 071-241	10	24V

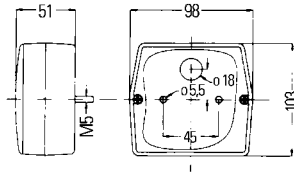

For horizontal or vertical surface mounting

Red rear and stop light, amber indicator light.
With illumination for 520 x 120 mm licence plates.
PC lens.

Two 5.5 mm dia. holes for fixing screws.
 With grommet, fixing screws for lens, one clear and one red lens for illumination of licence plate provided loose.

Part no.	Pk.	
2SE 998 530-061	1	Rear-stop-indicator-licence plate light
2SE 998 530-067	108	
Spare parts/Accessories:		
9EL 998 002-031	2	PC lens with screws
8GA 002 073-121	10	12V P21W bulb,
8GA 002 073-241	10	24V P21/5W bulb,
8GD 002 078-121	10	12V
8GD 002 078-241	10	24V
8GD 002 078-011	10	24V (Heavy Duty)

Universal light mounts

With rear-stop-indicator-licence plate lights.
Can be used at rear of towing vehicles with triple-chamber and dual-chamber (stop/indicator switch-over) light equipment.
When light mounts are attached to vehicles not used for agricultural or forestry applications installation of a rear fog light is necessary for new registration of vehicles.

Cross bar extendable from 1.32 to 2.08 m.
 With 7-pole plug for connection of an additional trailer.



Part no.	Pk.	
		Set includes:
		1 cross bar
		2 mounted lights with pre-fitted 12V bulbs
		2 triangular reflectors, red
		1 socket, 7-pole (for additional trailer)
		1 connection lead, 7500 mm long, with 7-pole plug
2XL 004 762-001	1	Universal light mounts
Spare parts/Accessories:		
2SE 004 623-001	1	Rear-stop-indicator-licence plate light
9EL 129 519-001	1	Lens
8RA 002 020-001	25	Reflector, red
8JB 001 943-001	1	7-pole socket
8JA 001 930-001	1	7-pole plug
8GA 002 071-131	10	R10W bulb, 12V
8GA 002 073-121	10	P21W bulb, 12V

Light mounts for trailers

With rear-stop-indicator lights.
When light mounts are attached to vehicles not used for agricultural or forestry applications installation of a rear fog light is necessary for new registration of vehicles.

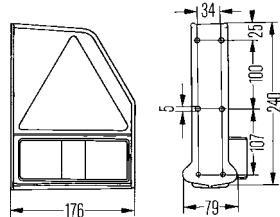

Part no.	Pk.	
		Set includes: 1 plastic mount 1 rear-stop-indicator light with pre-fitted 12V bulbs 1 triangular reflector, red 1 connection lead with 4-pole plug housing
2XL 005 194-011	1	Light mount, left
2XL 005 194-021	1	Light mount, right
		Spare parts/Accessories: Lens, left
9EL 118 700-001	1	right
9EL 118 701-001	1	Reflector, red
8RA 002 020-001	25	R10W bulb, 12V
8GA 002 071-131	10	P21W bulb, 12V
8GA 002 073-121	10	

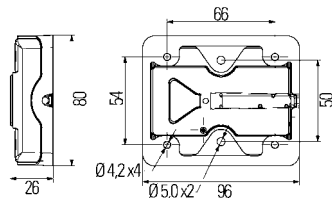

For horizontal or vertical surface mounting

In LED-technology. With eight 8 LEDs, 500 mm lead with stripped cable ends and firmly glued, red reflector 8RA 004 412-021.
Clear lens.

Rear light: 1.0W, stop light: 2.0W, indicator light: 2.0W.

Consumption:

rearlight: 0.08A at 12V, 0.04A at 24V,
stoplight: 0.17A at 12V, 0.08A at 24V,
indicator: 0.17A at 12V, 0.08A at 24V.

Black frame with four holes 4.2 mm dia. and two holes 5.0 mm dia. for fixing screws.

EMC-resistant. Type of protection: IP6K9K and IP6K7.
See LED instruction 1.

Part no.	Pk.	
2VA 980 720-001	1	Rear-stop-indicator light, 12V/24V
2VA 980 720-007	18	

For flush or surface mounting

In LED-technology. With 4 LEDs.
Lens red/amber/red with spare part lens clear.
Rear light: 4.0W, stop light: 3.0W, indicator light: 2.0W.
Consumption: 0.75A at 12V, 0.38A at 24V.
 Black plastic body.
 Voltage range: 9V - 32V.
 Light may be installed 2 x per vehicle side.
 See LED instruction 1.

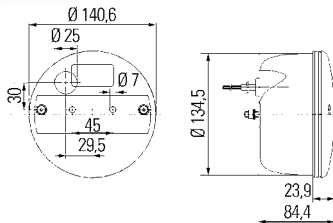
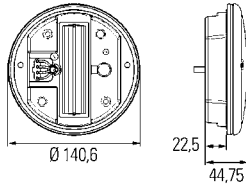

Part no.	Pk.	
2SD 344 100-001	1	Rear-stop-indicator light with two holes for fixing screws ST 4,8 and 500 mm lead, for flush mounting
2SD 344 100-007	40	
2SD 344 100-101	1	without lead, with two M6 x 20 fixing screws, for surface mounting

For horizontal surface mounting

Without legal regulations for indicator failure control, with passive electronic. The indicator failure control in the vehicle demanded by law within the scope of ECE has to be ensured.
The customer is responsible for this.

In LED-Technology. With 42 LEDs, grommet and 500 mm lead.
Red rear and stop light, amber indicator light.
Rear light: 0.5W, stop light: 2.0W, indicator light: 3.0W.
 Black plastic body.
 Two M6 fixing screws.
 Consumption: 0.23A at 24V.
 See LED instruction 4.

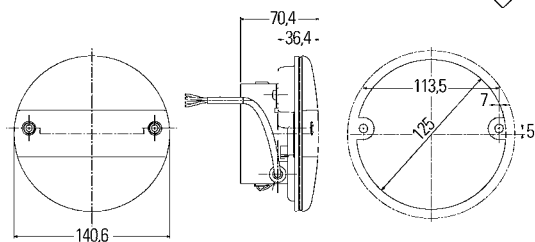

Part no.	Pk.	
2SD 001 685-347	20	Rear-stop and indicator light, 24V
5DS 009 602-001	1	Accessories: Control unit, 24V
4DM 009 492-001	1	Flasher unit, 24V,
4DM 009 492-011	1	2 + 1
	1	3 + 1

For horizontal surface mounting

Red rear and stop light, amber indicator light.

Black metal body. Two M6 fixing screws.

With heat-resistant lens.

Without vibration damping, grommet and bulbs.

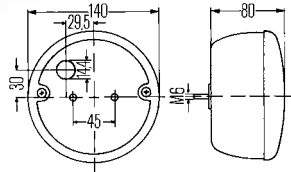

Part no.	Pk.	
2SD 001 685-307	8	Rear-stop-indicator light
Spare parts/Accessories:		
9EL 151 494-001	6	PC lens
8GA 002 071-121	1	R5W bulb,
8GA 002 071-241	1	12V
8GA 002 073-121	1	24V
8GA 002 073-121	2	P21W bulb,
8GA 002 073-241	2	12V
8GA 002 073-241	2	24V
9XD 997 909-801	1	Chrome-type mounted frame with mounting bracket for flush mounting

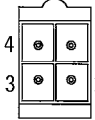

1	red	stop
2	white	ground
3	yellow	indicator
4	brown	rear



1	black/red	stop
2	grey	rear
3	brown	ground
4	black/white	indicator

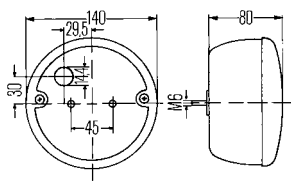

For horizontal surface mounting

Red rear and stop light, amber indicator light, clear licence plate light.
Two M6 fixing screws.

Part no.	Pk.	
2SD 001 685-211 2SD 001 685-218	1	Rear-stop-indicator light with grommet, without vibration damping and bulbs
	8	
2SD 001 685-277	240	with 150 mm cable set, 4-pole plug and 12V bulbs, without grommet
2SD 001 685-231 2SD 001 685-232	1	with vibration damping and grommet, without bulbs
	8	
2SD 001 685-317	60	4-pole AMP plug, 12V bulbs and vibration damping, without grommet
2SE 001 685-201	1	Rear-stop-indicator-licence plate light, for 520 x 120 mm and 340 x 240 mm licence plates, with grommet, without vibration damping and bulbs
2SE 001 685-221 2SE 001 685-227	1	with vibration damping and grommet, without bulbs
	8	
9EL 113 324-001	2	Spare parts: Lens with screws and joint (except for -317)
9FT 998 007-011	5	Bulb holder for -211/-218/-201
8GA 002 071-121	1	R5W bulb, 12V
8GA 002 071-241	1	24V
8GA 002 073-121	2	P21W bulb, 12V
8GA 002 073-241	2	24V
9XD 997 909-801	1	Chrome-type mounted frame with mounting bracket for flush mounting, for -211/-218/-231/-232

For horizontal surface mounting

Red rear and stop light, amber indicator light, clear licence plate light.

Black plastic body.
Bulb holder with vibration damping.
Two M6 fixing screws.
Only for spare parts requirement.

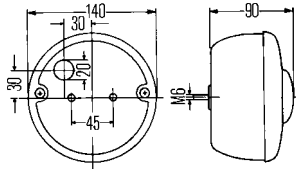

Part no.	Pk.	
2SD 001 686-101	1	Rear-stop-indicator light
2SE 001 686-142	1	Rear-stop-indicator-licence plate light, for 520 x 120 mm, 340 x 240 mm and 240 x 130 mm licence plates
Spare parts/Accessories:		
9EL 102 240-031	2	Lens with screws
8GA 002 071-121	10	R5W bulb, 12V
8GA 002 071-241	10	24V
8GA 002 073-121	10	P21W bulb, 12V
8GA 002 073-241	10	24V

Red rear and stop light, amber indicator light.

Black body.
Two M6 fixing screws.
National type test for Germany

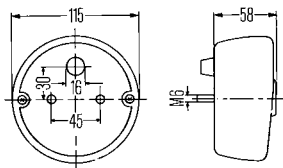

Part no.	Pk.	
2SD 001 679-001	1	Rear-stop-indicator light
2SE 001 679-051	1	Rear-stop-indicator-licence plate light, for 520 x 120 mm, 340 x 240 mm and 240 x 130 mm licence plates
Spare parts/Accessories:		
9EL 126 294-001	2	Lens with screws
8GM 002 091-131	10	K bulb, 12V10W
8GM 002 091-121	10	12V18W

Red rear light, amber stop-(indicator) light.

Black body. Two M6 fixing screws. With grommet.
Only for spare parts requirement.
National type test for Germany

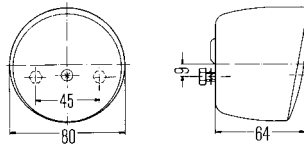

Part no.	Pk.	
2SB 001 301-021	2	Rear-stop-(indicator) light
Spare parts/Accessories:		
8GM 002 091-131	10	K bulb, 12V10W
8GM 002 091-121	10	12V18W

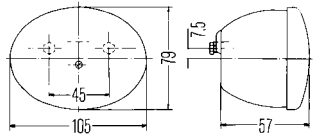

For horizontal surface mounting

Red rear light, amber stop-(indicator) light.

Black body. Two M6 fixing screws. With grommet.
Only for spare parts requirement.
National type test for Germany.

Part no.	Pk.	
2SB 001 673-002	1	Rear-stop-(indicator) light
2ST 001 673-011	1	Rear-stop-(indicator)-licence plate light, for 340 x 240 mm licence plates with 0°, 25° and 30° inclination or 240 x 130 mm with 0°- 30° inclination
Spare parts/Accessories:		
9EL 110 928-001	1	Lens with screw
8GA 002 071-131	1	R10W bulb, 12V
8GA 002 072-121	1	R bulb, 12V

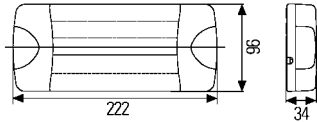

For horizontal surface mounting

DuraLED Combi

In LED-technology. Clear lens.
 With 40 LEDs and connecting cable 2500 mm with stripped cable ends.
Rear light: 1.0W, stop light: 5.0W, indicator light: 5.0W.
 Black body. Voltage range: 8V - 28V.
 Consumption: 0.92A at 12V, 0.46A at 24V.
 See LED instruction 1.

Part no.	Pk.	
2SD 959 050-401	1	Rear-stop-indicator light

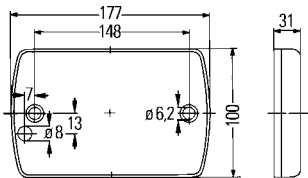

DuraLED

In LED-technology. Clear lens.
 With 24 red LEDs and connecting cable 2500 mm with stripped cable ends.
Rear light: 2.5W, stop light: 6.0W.
 Black body. Voltage range: 9V - 33V.
 Consumption:
 Rear light: 0.21A at 12V, 0.11A at 24V,
 stop light: 0.5A at 12V, 0.25A at 24V.
 See LED instruction 2.

Part no.	Pk.	
2SB 980 606-201	1	Rear-stop light for horizontal mounting
2SB 980 606-701	1	For vertical mounting

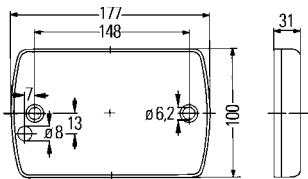

For rear mounting (category 2a)

DuraLED

In LED-technology. Clear lens.
 With 24 amber LEDs 4.0W and connecting cable 2500 mm with stripped cable ends.
 Black body. Voltage range: 9V - 33V.
 Consumption: 0.34A at 12V, 0.17A at 24V.
 See LED instruction 3.

Part no.	Pk.	
2BA 980 607-201	1	Indicator light for horizontal mounting
2BA 980 607-701	1	For vertical mounting

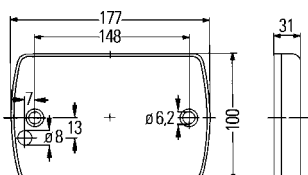

For horizontal surface mounting

DuraLED

In LED-technology. Clear lens.
With 24 white LEDs 4.0W and connecting cable 2500 mm with stripped cable ends.

Black body. Voltage range: 9V - 33V.
Consumption: 0.34A at 12V, 0.17A at 24V.
See LED instruction 3.

Part no.	Pk.	
ZZR 980 605-201	1	Reverse light for horizontal mounting
ZZR 980 605-701	1	For vertical mounting

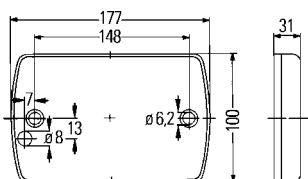

DuraLED

In LED-technology. Clear lens.
With 36 white LEDs 9.0W and connecting cable 2500 mm with stripped cable ends.

Black body. Voltage range: 9V - 33V.
Consumption: 0.75A at 12V, 0.38A at 24V.

Part no.	Pk.	
2JA 959 037-511	1	Interior light

For horizontal surface mounting

Lens with snap fastening.
Two 5.5 mm dia. holes for fixing screws.

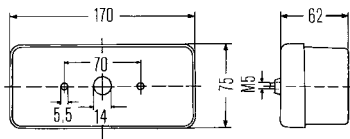

Part no.	Pk.	
		Red rear and stop light, amber indicator light.
		Rear-stop-indicator light, left
2SD 002 582-011	1	
2SD 002 582-017	32	
		Rear-stop-indicator light, right
2SD 002 582-021	1	
2SD 002 582-027	32	
		Spare parts:
		Lens with divider,
9EL 112 743-001	1	left
9EL 112 741-001	1	right
		R10W bulb,
8GA 002 071-131	10	12V
8GA 002 071-251	10	24V
		P21W bulb,
8GA 002 073-121	2	12V
8GA 002 073-241	2	24V
		Red rear and stop light, amber indicator light. with illumination for 520 x 120 mm and 340 x 240 mm licence plates.
		Rear-stop-indicator-licence plate light, left
2SE 002 582-071	1	
		Spare parts/Accessories:
		Lens with divider, left
9EL 116 844-001	1	R10W bulb,
8GA 002 071-131	10	12V
8GA 002 071-251	10	24V
		P21W bulb,
8GA 002 073-121	10	12V
8GA 002 073-241	10	24V
		For front mounting. Amber indicator light, clear position light.
		Indicator-position light
2BE 002 582-031	1	
		Spare parts/Accessories:
		Lens with divider
9EL 112 744-001	1	R5W bulb,
8GA 002 071-121	10	12V
8GA 002 071-241	10	24V
		P21W bulb,
8GA 002 073-121	10	12V
8GA 002 073-241	10	24V

For horizontal surface mounting

Two B3,9 x 16 fixing screws. With grommet.

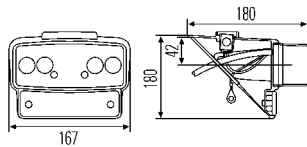
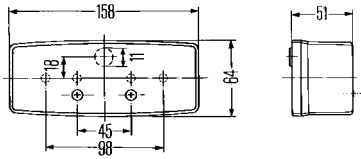

Part no.	Pk.	
		Red rear and stop light, amber indicator light.
2SD 003 184-031	1	Rear-stop-indicator light, left
2SD 003 184-037	45	
2SD 003 184-041	1	Rear-stop-indicator light, right
2SD 003 184-047	45	
		Spare parts:
		Lens with screws,
9EL 118 700-001	1	left
9EL 118 701-001	1	right
		Red rear and stop light, amber indicator light, clear licence plate light, for 340 x 240 mm licence plates.
2SE 003 184-011	1	Rear-stop-indicator-licence plate light, left
2SE 003 184-017	45	
2SE 003 184-101	1	Rear-stop-indicator-licence plate light, right
		Spare parts/Accessories:
		Lens with screws,
9EL 118 697-001	1	left
9EL 121 431-001	1	right
8GA 002 071-131	10	12V
8GA 002 071-251	10	24V
8GA 002 073-121	10	12V
8GA 002 073-241	10	24V
8RA 123 251-005	50	Reflector
9XD 132 749-005	8	Adapter
		For front mounting.
		Amber indicator light, clear position light.
2BE 003 184-051	1	Indicator-position light, left
2BE 003 184-061	1	Indicator-position light, right
		Spare parts/Accessories:
		Lens with screws,
9EL 118 703-001	1	left
9EL 118 705-001	1	right
8GA 002 071-121	10	12V
8GA 002 071-241	10	24V
8GA 002 073-121	10	12V
8GA 002 073-241	10	24V

For horizontal surface mounting

Black plastic body.
Two M5 fixing screws.

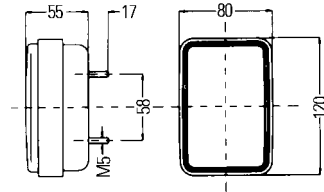

Part no.	Pk.	
		Red rear and stop light, amber indicator light.
2SD 997 131-051	1	Rear-stop-indicator light with blade terminal contacts
		Spare parts/Accessories:
9EL 997 469-001	2	Lens
8GA 002 073-121	10	P21W bulb, 12V
8GD 002 078-121	10	P21/5W bulb, 12V
		For front mounting. Amber indicator light, clear position light.
2BE 997 131-081	1	Indicator-position light without blade terminal contacts
2BE 997 131-207	1	Indicator-position light with blade terminal contacts
		Spare parts/Accessories:
9EL 997 459-001	2	Lens
8GA 002 073-121	10	P21W bulb, 12V
8GD 002 078-121	10	P21/5W bulb, 12V

For horizontal surface mounting

Steel base plate. Two M6 fixing screws.

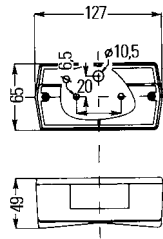

Part no.	Pk.	
		Red rear and stop light, amber indicator light.
2SD 997 006-031	1	Rear-stop-indicator light, left
2SD 997 006-021	1	Rear-stop-indicator light, right
		Accessories:
8GA 002 073-121	10	P21W bulb, 12V
8GA 002 073-241	10	P21W bulb, 24V
8GM 002 092-121	10	C5W bulb, 12V
8GM 002 092-241	10	C5W bulb, 24V
		Red rear and stop light, amber indicator light, clear licence plate light.
2SE 997 006-011	1	Rear-stop-indicator-licence plate light, left
		Spare parts/Accessories:
9EL 997 315-001	2	Lens with screws, left
8GA 002 073-121	10	P21W bulb, 12V
8GA 002 073-241	10	P21W bulb, 24V
8GM 002 092-121	10	C5W bulb, 12V
8GM 002 092-241	10	C5W bulb, 24V
		For front mounting.
		Amber indicator light, clear position light.
		With plug connector.
2BE 997 006-101	1	Indicator-position light
		Spare parts/Accessories:
8GA 002 071-121	10	R5W bulb, 12V
8GA 002 071-241	10	R5W bulb, 24V
8GA 002 073-121	10	P21W bulb, 12V
8GA 002 073-241	10	P21W bulb, 24V

For horizontal or vertical surface mounting

Red rear and stop light, amber indicator light, clear licence plate light.

Lens with snap fastening.

Two holes for M5 fixing screws. With grommet.

Only for spare parts requirement.

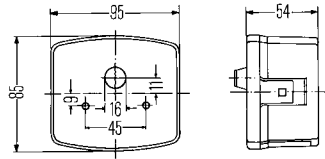

Part no.	Pk.	
2SD 003 182-051	1	Rear-stop-indicator light, left
2SD 003 182-057	120	
2SD 003 182-061	1	right
2SD 003 182-067	120	
Spare parts:		
9EL 118 614-011	2	Lens
8GA 002 071-131	10	R10W bulb, 12V
8GA 002 071-251	10	24V
8GA 002 073-121	10	P21W bulb, 12V
8GA 002 073-241	10	24V
Rear-stop-indicator-licence plate light, for 520 x 120 mm, 340 x 240 mm and 240 x 130 mm licence plates (above licence plates), or mounting to left and right of 520 x 120 mm licence plate, left		
2SE 003 182-011	1	
2SE 003 182-017	120	
2SE 003 182-021	1	right
2SE 003 182-027	120	
Spare parts/Accessories:		
9EL 118 613-001	2	Lens
8GA 002 071-131	10	R10W bulb, 12V
8GA 002 071-251	10	24V
8GA 002 073-121	10	P21W bulb, 12V
8GA 002 073-241	10	24V

Amber indicator light, white position light.

Lens with snap fastening.

Two holes for M5 fixing screws. With grommet.

Only for spare parts requirement.

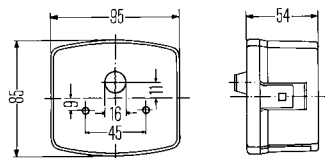

Part no.	Pk.	
2BE 003 182-091	1	Indicator-position light, left
2BE 003 182-101	1	right
Spare parts/Accessories:		
9EL 118 614-021	2	Lens
8GA 002 073-121	10	P21W bulb, 12V
8GA 002 073-241	10	24V
8GM 002 092-121	10	C5W bulb, 12V
8GM 002 092-241	10	24V

For horizontal or vertical surface mounting

Red rear and stop light, amber indicator light, clear licence plate light.

Lens with snap fastening.

Two holes for M5 fixing screws. With grommet.

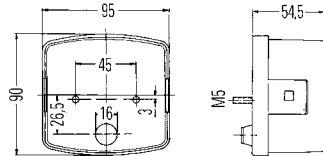

Part no.	Pk.	
2SD 002 776-231	1	Rear-stop-indicator light, left
2SD 002 776-237	110	
2SD 002 776-241	1	right
2SD 002 776-247	110	
Spare parts:		
Lens with heat dissipation plate,		
9EL 137 307-001	2	left
9EL 137 308-001	2	right
8GA 002 071-131	10	R10W bulb, 12V
8GA 002 073-121	10	P21W bulb, 12V
Rear-stop-indicator-licence plate light, for 520 x 120 mm, 340 x 240 mm and 240 x 130 mm licence plates (above licence plates), or mounting to left and right of 520 x 120 mm licence plate (amber flasher light at the top), left		
2SE 002 776-211	1	left
2SE 002 776-217	110	
2SE 002 776-221	1	right
Spare parts/Accessories:		
Lens,		
9EL 134 739-001	2	left
9EL 134 740-001	2	right
8GA 002 071-131	10	R10W bulb, 12V
8GA 002 073-121	10	P21W bulb, 12V

Amber indicator light, white position light.

Lens with snap fastening.

Two holes for M5 fixing screws. With grommet.

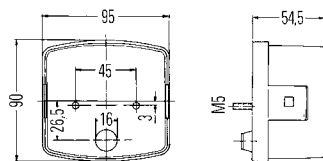

Part no.	Pk.	
2BE 002 776-251	1	Indicator-position light, left
2BE 002 776-257	72	
2BE 002 776-261	1	right
2BE 002 776-267	72	
Spare parts/Accessories:		
Lens,		
9EL 134 741-021	2	left
9EL 134 742-021	2	right
8GA 002 071-131	10	R10W bulb, 12V
8GA 002 073-121	10	P21W bulb, 12V

For horizontal surface mounting

Two 5.2 mm dia. holes for fixing screws.

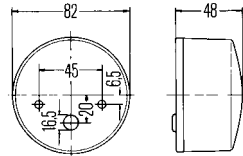

Part no.	Pk.	
		Red rear light, amber indicator light. Only for spare parts requirement.
2SW 003 185-041	1	Rear-indicator light
2SW 003 185-047	33	
		Spare parts:
9EL 118 633-001	4	Lens with screw
8GM 002 092-121	10	C5W bulb, 12V
8GA 002 073-121	10	P21W bulb, 12V
		For front mounting. Amber indicator light, white position light.
2BE 003 185-031	1	Indicator-position light
		Spare parts/Accessories:
9EL 119 397-001	4	Lens with screw
8GM 002 092-121	10	C5W bulb,
8GM 002 092-241	10	12V
		24V
8GA 002 073-121	10	P21W bulb,
8GA 002 073-241	10	12V
		24V

Black body. Two M6 fixing screws. With grommet.
Only for spare parts requirement.
National type test for Germany

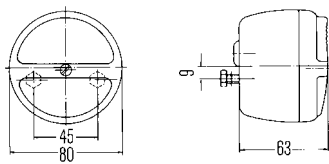

Part no.	Pk.	
		For horizontal surface mounting Red rear light, amber stop-(indicator) light, white licence plate light.
2SB 003 018-031	1	Rear-stop-(indicator) light
		Rear-stop-(indicator)-licence plate light, for 520 x 120 mm, 340 x 240 mm and 240 x 130 mm licence plates with 0°- 20° inclination
2ST 003 018-061	1	
		Spare parts/Accessories:
9EL 089 114-001	2	Lens with rim and screw
8GM 002 091-131	10	K bulb,
8GM 002 091-121	10	12V10W
		12V18W
		For front mounting. Amber indicator light, clear position light.
2BE 003 018-011	1	Indicator-position light
		Accessories:
8GM 002 091-121	10	K bulb, 12V
8GM 002 092-121	10	C5W bulb, 12V

For flush/surface mounting

In LED-technology. Clear lens.

When the ring 008 405-... is mounted in an assembly with the lights 008 221-..., the heat deflector shield has to be used (to be ordered separately). Use of the heat defelctor shield is required at an ambient temperature of > 50 °C. See LED instruction 2.

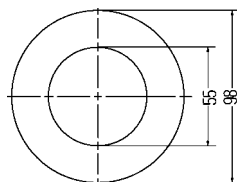

Part no.	Pk.	
		With 12 red LEDs 1.8W. Consumption: 0.15A at 12V, 0.08A at 24V.
2SA 008 405-021	1	Rear light, 12V
2SA 008 405-027	60	
2SA 008 405-011	1	Rear light, 24V
2SA 008 405-017	60	
		With 12 red LEDs 2.1W. Consumption: 0.18A at 12V, 0.09A at 24V.
2SB 008 405-101	1	Rear-stop light, 12V
2SB 008 405-091	1	Rear-stop light, 24V
		For front flush/surface mounting. With 12 white LEDs 1.8W. Consumption: 0.15A at 12V, 0.08A at 24V.
2PF 008 405-061	1	Position light, 12V
2PF 008 405-067	60	
2PF 008 405-051	1	Position light, 24V
2PF 008 405-057	60	
2PF 008 405-127	60	Position light with 200 mm long connecting lead and DEUTSCH plug connector, 24V
9XB 161 749-007	60	Accessories: Heat deflector shield
8RA 008 405-001	1	Reflector red, with additional lens clear
8RA 008 405-007	60	

To fit 90 mm dia. headlamps.

For flush mounting

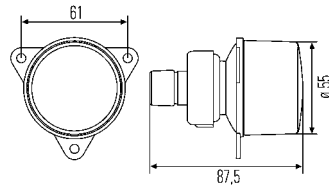

Part no.	Pk.	
2XA 008 221-021 2XA 008 221-027	1 20	Signal light with red lens, optional use as rear light (R5W) or stop light (P21W)
2SA 008 221-127	20	Rear light with red lens and 12V5W bulb
2DA 008 221-167	20	Stop light with red lens and 12V21W bulb
		Spare parts/Accessories:
8GA 002 071-121	10	R5W bulb, 12V
8GA 002 071-241	10	24V
8GA 002 073-121	10	P21W bulb, 12V
8GA 002 073-241	10	24V
8KA 152 134-007	20	Lead with grommet, 500 mm long
8XU 008 405-031	1	Decorative moulding (illustration similar to reflector)
8XU 008 405-037	60	
9GT 137 236-007	20	Grommet
2NE 008 221-031 2NE 008 221-037	1 20	Rear fog light with red lens, without bulb
2NE 008 221-137	20	with 12V bulb
		Spare parts/Accessories:
8GA 002 073-121	10	P21W bulb, 12V
8GA 002 073-241	10	24V
8KA 152 134-007	20	Lead with grommet, 500 mm long
8XU 008 405-031	1	Decorative moulding (illustration similar to reflector)
8XU 008 405-037	60	
9GT 137 236-007	20	Grommet
2BA 008 221-001 2BA 008 221-007	1 20	Indicator light for front flush mounting with clear lens without bulb
2BA 008 221-107 2BA 008 221-217	20 20	with amber 12V bulb with amber 24V-HD bulb
2BA 008 221-041 2BA 008 221-047	1 20	Indicator light for rear flush mounting, with grey lens, without bulb
2BA 008 221-147	20	without bulb with amber 12V bulb
		Spare parts/Accessories:
8GA 006 841-121	10	PY21W bulb, 12V
8GA 006 841-241	10	24V
8GA 006 841-251	10	24V (HD)
8KA 152 134-007	20	Lead with grommet, 500 mm long
8XU 008 405-031	1	Decorative moulding (illustration similar to reflector)
8XU 008 405-037	60	
9GT 137 236-007	20	Grommet



To fit 90 mm dia. headlamps.

For flush mounting

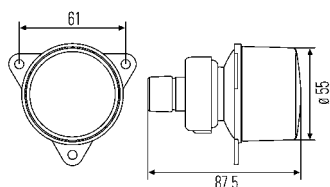

Part no.	Pk.	
2PF 008 221-011 2PF 008 221-017	1 20	Position light for front flush mounting, with clear lens, without bulb
2PF 008 221-177	20	with 12V bulb
		Spare parts/Accessories:
		R5W bulb,
8GA 002 071-121	10	12V
8GA 002 071-241	10	24V
8KA 152 134-007	20	Lead with grommet, 500 mm long
8XU 008 405-031	1	Decorative moulding (illustration similar to reflector)
8XU 008 405-037	60	
9GT 137 236-007	20	Grommet
2ZR 008 221-051 2ZR 008 221-057	1 20	Reverse light with grey lens, without bulb
2ZR 008 221-157	20	with 12V bulb
		Spare parts/Accessories:
		P21W bulb,
8GA 002 073-121	10	12V
8GA 002 073-241	10	24V
8KA 152 134-007	20	Lead with grommet, 500 mm long
8XU 008 405-031	1	Decorative moulding (illustration similar to reflector)
8XU 008 405-037	60	
9GT 137 236-007	20	Grommet

To fit 90 mm dia. headlamps.

For horizontal surface mounting

In LED-technology.

Red rear and stop light with 16 LEDs 2.3W.

Consumption: 0.19A at 12V, 0.10A at 24V.

For lights in model range 009 001-...

See LED instruction 2.

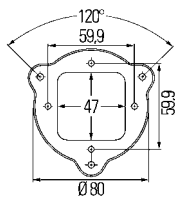
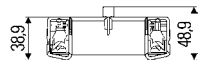
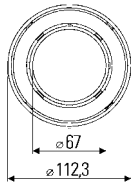
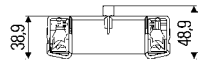
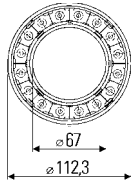

Part no.	Pk.	Description
2SB 009 362-021	1	Rear-stop light with clear lens, 12V
2SB 009 362-041	1	Rear-stop light with red lens, 12V
2SB 009 362-011	1	with red lens, 24V
8RA 009 362-001	1	Reflector, red
8XU 009 362-101	1	Accessories: Design rim, red
8XU 009 362-111	1	clear
9HB 163 085-001	10	Design rim for 2SB/8XU 009 362-..., silver coloured
9HB 163 085-012	1	chrome coloured
9XD 161 119-017	30	Adapter rim for rear-stop lights and for mounting of reflector

For flush mounting

In LED-technology. Clear lens. With AMP plug.

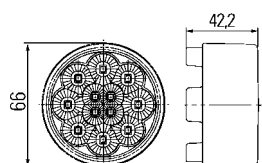

Part no.	Pk.	
		With 12 red Power LEDs. Rear light: 0.5W, stop light: 2.5W. Consumption: 0.25A at 12V, 0.13A at 24V. See LED instruction 2.
2SB 009 001-401	1	Rear-stop light, 12V
2SB 009 001-501	1	Rear-stop light, 24V
8JD 162 581-802	1	Accessories: Plug-set, 3-poles
		For rear mounting. With 12 amber Power LEDs, 2.4W. Consumption: 0.2A at 12V, 0.1A at 24V. See LED instruction 3.
2BA 009 001-411	1	Indicator light, 12V
2BA 009 001-511	1	Indicator light, 24V
2BA 009 001-431	1	Indicator light with failure control, 12V
2BA 009 001-531	1	Indicator light with failure control, 24V
8JD 156 150-807	1	Accessories: Plug-set, 2-poles
		For front mounting. With 12 white Power LEDs, 1.8W. Consumption: 0.15A at 12V, 0.08A at 24V. See LED instruction 2.
2PF 009 001-421	1	Position light, 12V
2PF 009 001-521	1	Position light, 24V
8JD 156 150-807	1	Accessories: Plug-set, 2-poles

For flush mounting

With bulb and AMP plug.

Red lens without optical pattern, bonded to body, facet reflector.

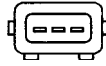

Part no.	Pk.	
Red lens		
2SA 009 001-041	1	Rear light, 12V
2SA 009 001-047	60	
2SA 009 001-137	1	Rear light, 24V
Spare parts/Accessories:		
8GD 002 078-121	10	P21/5W bulb, 12V
8GD 002 078-241	10	24V
8JD 162 581-802	1	Plug-set, 3-poles
Red lens.		
2SB 009 001-061	1	Rear-stop light, 12V
2SB 009 001-067	60	
2SB 009 001-157	60	Rear-stop light, 24V
Spare parts/Accessories:		
8GD 002 078-121	10	P21/5W bulb, 12V
8GD 002 078-241	10	24V
8JD 162 581-802	1	Plug-set, 3-poles
Red lens		
2DA 009 001-051	1	Stop light, 12V
2DA 009 001-057	60	
2DA 009 001-147	1	Stop light, 24V
Spare parts/Accessories:		
8GA 002 073-121	10	P21W bulb, 12V
8GA 002 073-241	10	24V
8JD 156 150-807	1	Plug-set, 2-poles
Red lens.		
2NE 009 001-021	1	Rear fog light, 12V
2NE 009 001-027	60	
2NE 009 001-127	1	Rear fog light, 24V
Spare parts/Accessories:		
8GH 008 417-001	1	H21W bulb, 12V
8GH 008 417-012	1	24V
8JD 156 150-807	1	Plug-set, 2-poles
For front mounting. Clear lens.		
2PF 009 001-081	1	Position light, 12V
2PF 009 001-177	60	Position light, 24V
Spare parts/Accessories:		
8GD 002 078-121	10	P21/5W bulb, 12V
8GD 002 078-241	10	24V
8JD 162 581-802	1	Plug-set, 3-poles

For flush mounting

With bulb and AMP plug.

Red lens without optical pattern, bonded to body, facet reflector.



2BA 009 001-001 1
2BA 009 001-007 60
2BA 009 001-107 1

For rear mounting.
Smoke coloured lens. Amber bulb.
Indicator light, 12V
Indicator light, 24V



8GA 006 841-121 10
8GA 006 841-241 1
8JD 156 150-807 1

Spare parts/Accessories:
 PY21W bulb,
 12V
 24V
 Plug-set, 2-poles



2BA 009 001-071 1
2BA 009 001-077 60
2BA 009 001-167 60

For front mounting.
Clear lens. Amber bulb.

Indicator light, 12V
Indicator light, 24V

Spare parts/Accessories:
 PY21W bulb,
 12V
 24V
 Plug-set, 2-poles



2BA 009 001-191 1

Silver bulb.
Indicator light with grey lens, for rear mounting



2BA 009 001-201 1

Indicator light with clear lens, for front mounting

8GA 002 073-121 10
8GA 002 073-241 10
8JD 156 150-807 1

Spare parts/Accessories:
 P21W bulb,
 12V
 24V
 Plug-set, 2-poles



2ZR 009 001-011 1
2ZR 009 001-017 60
2ZR 009 001-117 60

Grey lens.
Reverse light, 12V
Reverse light, 24V

8GA 002 073-121 10
8GA 002 073-241 10
8JD 156 150-807 1

Spare parts/Accessories:
 P21W bulb,
 12V
 24V
 Plug-set, 2-poles

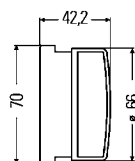

8RA 009 001-031 1
8RA 009 001-037 60

Reflector, red for lights in model range 009 001-...

Accessories for lights in model range 009 001-... (except LED)

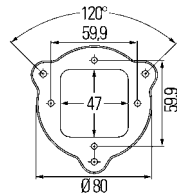

Part no.	Pk.	Description
9HB 161 122-007	1	Design rim silver coloured
9HB 161 122-012	10	Design rim, chrome-plated
9HB 164 168-002	10	Premium design rim comet silver coloured
8HG 162 530-002	60	Locking ring comet-silver coloured
9XD 161 119-007	30	Adapter rim with gasket, for front fixing
8JD 156 150-807	1	Plug-set, 2-poles
8JD 162 581-802	1	3-pole

For flush mounting

With bulb, 100 mm lead, blade terminal contacts and with insulating sleeves. Fixing clip and screw (Torx TX 20) are provided loose.

Lens without optical pattern. For screw- or clip fixing.
(max. depth required up to lens gradient)

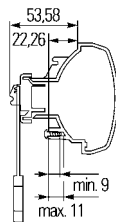
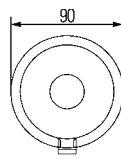

Part no.	Pk.	
Red lens.		
2SA 965 039-001	1	Rear light, 12V
2SA 965 039-007	24	
2SA 965 039-081	1	Rear light, 24V
2SA 965 039-087	24	
2SA 965 039-307	24	Rear light with clip fixing, 24V
Spare parts:		
8GA 002 071-121	10	R5W bulb, 12V
8GA 002 071-241	10	R5W bulb, 24V
Red lens.		
2SB 965 039-051	1	Rear-stop light, 12V
2SB 965 039-057	24	
2SB 965 039-131	1	Rear-stop light, 24V
2SB 965 039-137	24	
Spare parts:		
8GD 002 078-121	10	P21/5W bulb, 12V
8GD 002 078-241	10	P21/5W bulb, 24V
Red lens		
2DA 965 039-011	1	Stop light, 12V
2DA 965 039-091	1	Stop light, 24V
2DA 965 039-317	24	Stop light with clip fixing, 12V
Red lens		
2NE 965 039-031	1	Rear fog light, 12V
2NE 965 039-037	24	
2NE 965 039-111	1	Rear fog light, 24V
2NE 965 039-117	24	
2NE 965 039-327	24	Rear fog light with clip fixing, 12V
Spare parts:		
8GA 002 073-121	10	P21W bulb, 12V
8GA 002 073-241	10	P21W bulb, 24V
For front mounting. Clear lens.		
2PF 965 039-071	1	Position light, 12V
2PF 965 039-077	24	
2PF 965 039-151	1	Position light, 24V
Spare parts:		
8GA 002 071-121	10	R5W bulb, 12V
8GA 002 071-241	10	R5W bulb, 24V

For flush mounting

With bulb, 100 mm lead, blade terminal contacts and with insulating sleeves. Fixing clip and screw (Torx TX 20) are provided loose.

Lens without optical pattern. For screw- or clip fixing.
(max. depth required up to lens gradient)

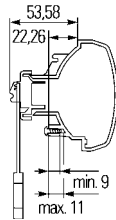
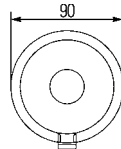

Part no.	Pk.	
Clear lens.		
2PT 965 039-171	1	Daytime running light, 24V
2PT 965 039-177	24	
Spare parts: P21W bulb,		
8GA 002 073-121	10	12V
8GA 002 073-241	10	24V
For rear mounting. Smoke coloured lens. Amber bulb.		
2BA 965 039-021	1	Indicator light, 12V
2BA 965 039-027	24	
2BA 965 039-101	1	Indicator light, 24V
2BA 965 039-107	24	
For front mounting. Clear lens. Amber bulb.		
2BA 965 039-061	1	Indicator light, 12V
2BA 965 039-067	24	
2BA 965 039-141	1	Indicator light, 24V
2BA 965 039-147	24	
Spare parts: PY21W bulb,		
8GA 006 841-121	10	12V
8GA 006 841-241	10	24V
Smoke coloured lens.		
2ZR 965 039-041	1	Reverse light, 12V
2ZR 965 039-047	24	
2ZR 965 039-121	1	Reverse light, 24V
2ZR 965 039-127	24	
2ZR 965 039-337	24	Reverse light with clip fixing, 12V
Spare parts: P21W bulb,		
8GA 002 073-121	10	12V
8GA 002 073-241	10	24V

For horizontal surface mounting

Black plastic body.
Two M6 fixing screws. With grommet.

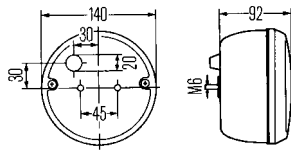

Part no.	Pk.	
		Red lens. Black base plate. Two lights can be fitted next to each other.
2SB 001 423-097	1	Rear-stop light
9EL 101 353-001	1	Spare parts/Accessories: Lens with screws
8GD 002 078-121	10	P21/5W bulb, 12V
8GD 002 078-241	10	24V
8GD 002 078-011	10	24V (HD)
		Red lens.
2DA 001 423-077	24	Stop light
9EL 101 353-001	1	Spare parts/Accessories: Lens with screws
8GA 002 073-121	10	P21W bulb, 12V
8GA 002 073-241	10	24V
		Red lens.
2NE 001 423-011	1	Rear fog light
9EL 101 353-001	1	Spare parts/Accessories: Lens with screws
8GA 002 073-121	10	P21W bulb, 12V
8GA 002 073-241	10	24V
		Amber lens.
2BA 001 423-087	1	Indicator light
8GA 002 073-121	10	Accessories: P21W bulb, 12V
8GA 002 073-241	10	24V
		Clear lens.
2ZR 001 423-001	1	Reverse light
9ES 106 588-001	1	Spare parts/Accessories: Lens
8GA 002 073-121	10	P21W bulb, 12V
8GA 002 073-241	10	24V
9XD 997 909-801	1	Accessories: Mounting frame for flush mounting

For flush mounting

In LED-technology. With 2500 mm lead.

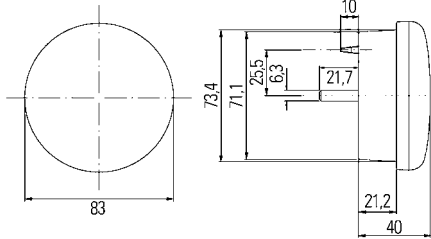

Part no.	Pk.	
		With 16 LEDs 24V. Red/amber lens. Rear light: 1.0W, stop light: 2.0W, indicator light: 2.0W. Consumption: 0.21A. See LED instruction 2.
2SD 959 010-401	1	Rear-stop-indicator light
2SD 959 010-407	10	
		With 12 LEDs 24V. Red lens. Rear light: 1.0W, stop light: 3.0W. Consumption: 0.13A. See LED instruction 2.
2SB 959 010-301	1	Rear-stop light
2SB 959 010-307	10	
		With 12 LEDs 24V3W. Amber lens. Consumption: 0.13A. See LED instruction 3.
2BA 959 011-301	1	Indicator light
2BA 959 011-307	10	for rear mounting
		With 24 red LEDs 24V3,0W. Clear lens. Consumption: 0.25A at 12V, 0.13A at 24V. Voltage range: 9V - 33V. See LED instruction 2.
2NE 959 011-501	1	Rear fog light
2NE 959 011-507	10	
		With 24 white LEDs 24V4,0W. Clear lens. Consumption: 0.33A at 12V, 0.17A at 24V. See LED instruction 2.
2ZR 959 010-501	1	Reverse light
2ZR 959 010-507	10	
9GD 980 696-001	1	Accessories: Mounting ring

For flush/surface mounting

In LED-technology. With 24 LEDs and 500 mm lead.
Rear light: 1.0W, stop light: 1.5W, indicator light: 2.0W.

Black plastic body.
 With two M6 x 25 fixing screws.
 Voltage range: 9V - 31V. Consumption: 0.4A at 12V, 0.2A at 24V.
 See LED instruction 1.

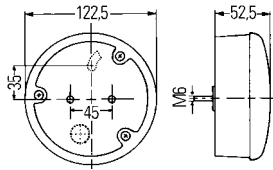

Part no.	Pk.	
2SD 344 200-001	1	Rear-stop-indicator light with clear lens
2SD 344 200-007	24	
2SD 344 200-071	1	with red/clear lens
2SD 344 200-077	24	

In LED-technology. With 24 LEDs and 500 mm lead.
Rear light: 1.0W, stop light: 3.0W.

Black plastic body.
 With two M6 x 25 fixing screws.
 Voltage range: 9V - 31V. Consumption: 0.34A at 12V, 0.17A at 24V.
 See LED instruction 2.

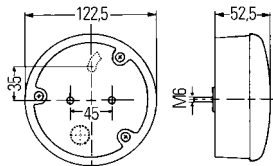

Part no.	Pk.	
2SB 344 200-027	24	Rear-stop light with clear lens
2SB 344 200-081	1	with red lens
2SB 344 200-087	24	

In LED-technology. With 24 LEDs 3.0W and 500 mm lead.

Black plastic body.
 With two M6 x 25 fixing screws.
 Voltage range: 9V - 31V. Consumption: 0.25A at 12V, 0.13A at 24V.
 See LED instruction 3.

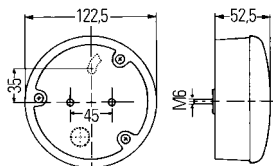

Part no.	Pk.	
2BA 344 200-037	24	Indicator light with clear lens

For flush/surface mounting

In LED-technology. With 24 LEDs 2.0W and 500 mm lead.

Black plastic body.

With two M6 x 25 fixing screws.

Voltage range: 9V - 31V. Ca. Consumption: 0.17A at 12V, 0.08A at 24V.

See LED instruction 2.

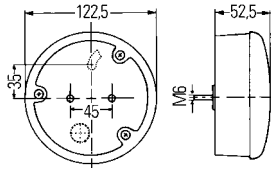
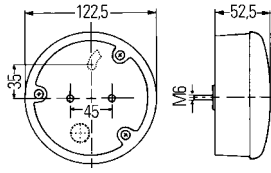

Part no.	Pk.	
2NE 344 200-061	1	Rear fog light with clear lens
2NE 344 200-067	24	
2NE 344 200-091	1	with red lens
2NE 344 200-097	24	

In LED-technology. With 24 LEDs 2.0W and 500 mm lead.

Black plastic body.

With two M6 x 25 fixing screws.

Voltage range: 9V - 31V. Ca. Consumption: 0.17A at 12V, 0.08A at 24V.

See LED instruction 2.

Part no.	Pk.	
2ZR 344 200-051	1	Reverse light with clear lens
2ZR 344 200-057	24	

For horizontal surface mounting

Without legal regulations for indicator failure control, with passive electronic. The indicator failure control in the vehicle demanded by law within the scope of ECE has to be ensured.

The customer is responsible for this.

In LED-technology. With 24 LEDs and 500 mm lead.
 Rear light: 1.0W, stop light: 1.5W, indicator light: 2.0W.
 Black plastic body
 With two M6 x 25 fixing screws.
 Consumption: 0.4A at 12V, 0.2A at 24V.
 Type of protection: IP6K9K. See LED instruction 4.

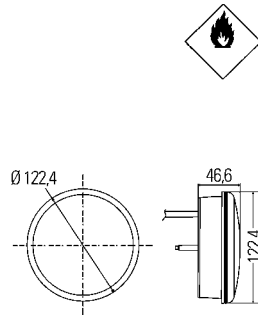

Part no.	Pk.	
2SD 344 200-201	1	Rear-stop-indicator light with clear lens, 12V
2SD 344 200-207	24	
2SD 344 200-211	1	with red/clear lens, 12V
2SD 344 200-217	24	
2SD 344 200-311	1	with red/clear lens, 24V
2SD 344 200-317	24	
2SD 344 200-251	1	with red/amber lens, 24V
2SD 344 200-257	24	
4JZ 177 846-007	24	Accessories: Flasher unit, 9V - 33V
8JA 003 526-001	5	

In LED-technology. With 24 LEDs and 500 mm lead.

Rear light: 1.0W, stop light: 5.0W.

Black plastic body
 With two M6 x 25 fixing screws.
 Consumption: 0.34A at 12V, 0.17A at 24V.
 Type of protection: IP6K9K. See LED instruction 2.

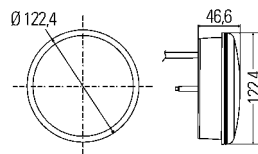

Part no.	Pk.	
2SB 344 200-221	1	Rear-stop light with clear lens, 12V
2SB 344 200-227	24	
2SB 344 200-321	1	with clear lens, 24V
2SB 344 200-327	24	
2SB 344 200-231	1	with red lens, 12V
2SB 344 200-237	24	
2SB 344 200-331	1	with red lens, 24V
2SB 344 200-337	24	

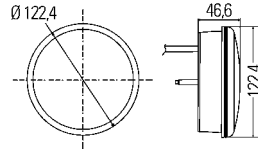

For horizontal surface mounting

Without legal regulations for indicator failure control, with passive electronic. The indicator failure control in the vehicle demanded by law within the scope of ECE has to be ensured. The customer is responsible for this.

In LED-technology. With 24 LEDs 2.0W and 500 mm lead.

Black plastic body.
With two M6 x 25 fixing screws.
Consumption: 0.17A at 12V, 0.09A at 24V.
Type of protection: IP6K9K. See LED instruction 4.

Part no.	Pk.	
2BA 344 200-241	1	Indicator light with clear lens, 12V
2BA 344 200-247	24	
2BA 344 200-341	1	with clear lens, 24V
2BA 344 200-347	24	
Accessories:		
4JZ 177 846-007	24	Flasher unit, 9V - 33V
8JA 003 526-001	5	Socket, 9-pole

For flush/surface mounting

Without legal regulations for indicator failure control, with passive electronic. The indicator failure control in the vehicle demanded by law within the scope of ECE has to be ensured. The customer is responsible for this.

In LED-technology. With 37 LEDs and 500 mm lead.

Black plastic body.
With two M6 x 25 fixing screws.
See LED instruction 4.

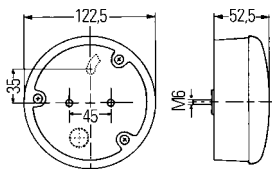

Part no.	Pk.	
		Clear lens. Rear light: 0.7W, stop light: 5.0W, indicator light: 4.6W. Consumption: 0.86A at 12V, 0.43A at 24V.
2SD 964 169-411	1	Rear-stop-indicator light, 12V, left
2SD 964 169-401	1	
2SD 964 169-331	1	Rear-stop-indicator light, 24V, left
2SD 964 169-337	36	
2SD 964 169-421	1	Rear-stop-indicator light, 24V, right
Accessories:		
4JZ 177 846-007	24	Flasher unit, 9V - 33V
8JA 003 526-001	5	Socket, 9-pole

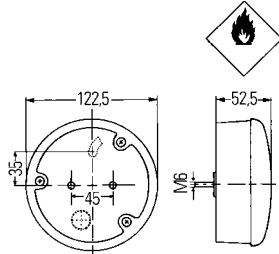

For flush/surface mounting

In LED-technology. With 37 LEDs and 500 mm lead.
 Black plastic body.
 With two M6 x 25 fixing screws.
 See LED instruction 2.

Part no.	Pk.	
		Red lens. Rear light: 0.7W, stop light: 5.0W. Consumption: 0.24A.
2SB 964 169-301	1	Rear-stop light, 24V
2SB 964 169-307	36	

Without legal regulations for indicator failure control, with passive electronic. The indicator failure control in the vehicle demanded by law within the scope of ECE has to be ensured. The customer is responsible for this.

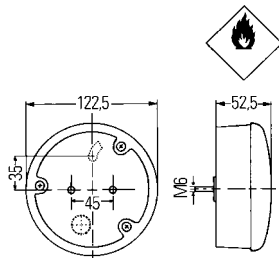

In LED-technology. With 37 LEDs and 500 mm lead.
 Black plastic body.
 With two M6 x 25 fixing screws.
 See LED instruction 4.

Part no.	Pk.	
		Amber lens. Indicator light: 9.0W. Consumption: 0.38A at 24V. Indicator light, 24V
2BA 964 169-311	1	Accessories: Flasher unit, 9V - 33V Socket, 9-pole
4JZ 177 846-007	24	
8JA 003 526-001	5	

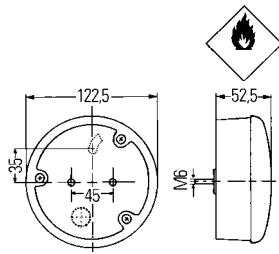

In LED-technology. With 37 LEDs and 500 mm lead.
 Black plastic body.
 With two M6 x 25 fixing screws.
 See LED instruction 2.

Part no.	Pk.	
		Red lens. Rear fog light: 4.0W. Consumption: 0.17A.
2NE 964 169-341	1	Rear fog light, 24V
		Clear lens. Reverse light: 5.0W Consumption: 0.21A.
2ZR 964 169-351	1	Reverse light, 24V, left
2ZR 964 169-361	1	Reverse light, 24V, right

For flush/surface mounting

Caution: The water drainage opening must be knocked out according to the attachment position!

Black plastic body.

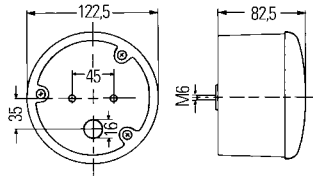
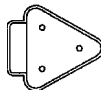

Part no.	Pk.	
		Red lens, without optical pattern. With grommet.
2SB 964 169-531	1	Rear-stop light with two M6 x 25 fixing screws
2SB 964 169-537	20	
2SB 964 169-677	20	Rear-stop light without fixing screws
		Red lens, without optical pattern. with 200 mm lead, 24V bulb and 3-pole DEUTSCH plug.
2SB 344 169-017	20	Rear-stop light with two M6 x 25 fixing screws
		Spare parts/Accessories:
9EL 964 800-011	1	Lens with screws for -531/-537/-017
9GT 341 438-007	200	Grommet
8GD 002 078-121	10	P21/5W bulb, 12V
8GD 002 078-241	10	24V
		Red lens, without optical pattern. With grommet.
2NE 964 169-521	1	Rear fog light with two M6 x 25 fixing screws
2NE 964 169-527	20	
2NE 964 169-667	20	Rear fog light without fixing screws
		Amber lens, without optical pattern. With grommet.
2BA 964 169-501	1	Indicator light with two M6 x 25 fixing screws
2BA 964 169-507	20	
2BA 964 169-647	20	Indicator light without fixing screws
		Amber lens, without optical pattern. with 200 mm lead, 24V bulb and 2-pole DEUTSCH plug.
2BA 344 169-007	20	Indicator light with two M6 x 25 fixing screws
		Clear lens, without optical pattern. With grommet.
2ZR 964 169-511	1	Reverse light with two M6 x 25 fixing screws
2ZR 964 169-517	20	
2ZR 964 169-657	20	Reverse light without fixing screws
		Spare parts/Accessories:
9EL 964 527-011	1	Lens with screws for -501/-507/-007
9EL 964 529-011	1	for -511/-517
9GT 341 438-007	200	Grommet
8GA 002 073-121	10	P21W bulb, 12V
8GA 002 073-241	10	24V

For surface/flush mounting

Caution: The water drainage opening must be knocked out according to the attachment position!

Black plastic body.

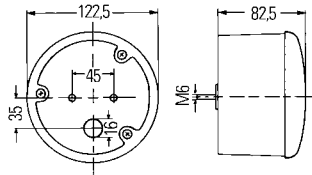

Part no.	Pk.	
		Red rear and stop light, amber indicator light. With grommet.
2SD 964 169-111	1	Rear-stop-indicator light with two M6 x 25 fixing screws
2SD 964 169-117	20	
2SD 344 169-037	20	Rear-stop-indicator light with two M6 x 12 fixing screws
		Spare parts/Accessories:
9EL 964 536-001	1	Lens with screws
9GT 341 438-007	200	Grommet
8GD 002 078-121	10	P21/5W bulb, 12V
8GD 002 078-241	10	P21W bulb, 24V
8GA 002 073-121	10	12V
8GA 002 073-241	10	24V
		Red lens. With grommet. Two lights can be fitted next to each other.
2SA 964 169-091	1	Rear light with two M6 x 25 fixing screws
2SA 964 169-097	20	
2SA 964 169-277	20	Rear light without fixing screws
		Spare parts/Accessories:
9EL 964 535-001	1	Lens with screws
9GT 341 438-007	200	Grommet
8GA 002 071-121	10	R5W bulb, 12V
8GA 002 071-241	10	24V

For surface/flush mounting

Caution: The water drainage opening must be knocked out according to the attachment position!

Black plastic body.

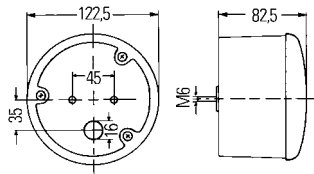
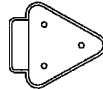
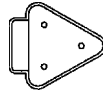

Part no.	Pk.	
		Red lens. With grommet.
2TA 964 169-061	1	Rear-stop light with reflector with two M6 x 25 fixing screws
2TA 964 169-067	20	
		Red lens. With 150 mm lead, bulb and 3-pole DEUTSCH plug.
2TA 964 169-767	20	Rear-stop light with reflector, 12V, with two M6 x 25 fixing screws
2TA 344 169-077	20	Rear-stop light with reflector, 24V, with two M6 x 25 fixing screws, left
2TA 344 169-087	20	Rear-stop light with reflector, 24V, with two M6 x 25 fixing screws, right
2TA 964 169-797	20	Rear-stop light with reflector, 12V, with two M6 x 45 fixing screws, left
		Red lens. With grommet. For two-wheeled vehicles.
2SB 964 169-287	20	Rear-stop light with two M6 x 25 fixing screws
2SB 964 169-717	20	Rear-stop light without fixing screws
		Spare parts/Accessories:
9EL 964 532-001	1	Lens with screws for 2TA 964 169-...
9GT 341 438-007	200	Grommet
8GD 002 078-121	10	P21/5W bulb, 12V
8GD 002 078-241	10	24V

For flush/surface mounting

Caution: The water drainage opening must be knocked out according to the attachment position!
Black plastic body.

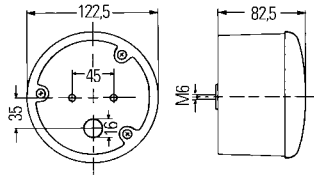

Part no.	Pk.	
		Red rear light, amber indicator light. With grommet.
2SW 964 169-081	1	Rear-indicator light with two M6 x 25 fixing screws
2SW 964 169-087	20	
		Spare parts/Accessories:
9EL 964 534-001	1	Lens with screws
9GT 341 438-007	200	Grommet
8GA 002 071-121	10	R5W bulb, 12V
8GA 002 071-241	10	24V
8GA 002 073-121	10	P21W bulb, 12V
8GA 002 073-241	10	24V
		Red lens. With grommet. Two lights can be fitted next to each other.
		Stop light with two M6 x 25 fixing screws
2DA 964 169-001	1	
2DA 964 169-007	20	
2DA 964 169-727	20	Stop light without fixing screws
		Red lens. With grommet.
		Rear fog light with two M6 x 25 fixing screws
2NE 964 169-021	1	
2NE 964 169-027	20	
		Rear fog light without fixing screws
2NE 964 169-227	20	
		Rear fog light with hexagonal recess, without fixing screws
2NE 344 169-047	20	
		Red lens. With 24V bulb, 200 mm lead and 3-pole DEUTSCH plug.
		Rear fog light with two M6 x 25 fixing screws, left
2NE 344 169-117	20	
		Rear fog light with two M6 x 25 fixing screws, right
2NE 344 169-067	20	
		Amber lens (category 1a / 2a). With grommet. Two lights can be fitted next to each other.
		Indicator light with two M6 x 25 fixing screws
2BA 964 169-011	1	
2BA 964 169-017	20	
		Indicator light without fixing screws
2BA 344 169-027	20	
		Spare parts/Accessories:
9EL 964 526-001	1	Lens with screws for 2DA 964 169-...
9EL 964 527-001	1	for 2BA 964 169-...
9GT 341 438-007	200	Grommet
8GA 002 073-121	10	P21W bulb, 12V
8GA 002 073-241	10	24V

For flush/surface mounting

Caution: The water drainage opening must be knocked out according to the attachment position!

Black plastic body.

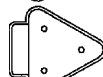
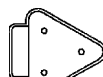
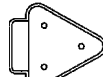
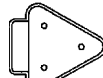
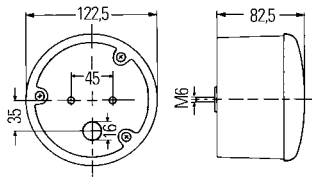

Part no.	Pk.	
		Amber indicator light, red rear fog light. With grommet.
2BA 964 169-041	1	Indicator-rear fog light with two M6 x 25 fixing screws.
2BA 964 169-047	20	
2BA 964 169-237	20	Indicator-rear fog light without fixing screws
		Amber indicator light, white reverse light. With grommet.
2BN 964 169-051	1	Indicator-reverse light with two M6 x 25 fixing screws
2BN 964 169-057	20	
2BN 964 169-247	20	Indicator-reverse light without fixing screws
		Amber indicator light, clear reverse light. With 150 mm lead and 3-pole DEUTSCH plug.
2BN 964 169-777	20	Indicator-reverse light with two M6 x 25 fixing screws and 12V bulbs, left
2BN 964 169-787	20	Indicator-reverse light with two M6 x 45 fixing screws and 12V bulbs, right
2BN 344 169-097	20	Indicator-reverse light with two M6 x 25 fixing screws and 24V bulbs, left
2BN 344 169-107	20	Indicator-reverse light with two M6 x 25 fixing screws and 24V bulbs, right
		Spare parts/Accessories:
9EL 964 530-001	1	Lens with screws for 2BA 964 169-...
9EL 964 533-001	1	for 2BN 964 169-...
9GT 341 438-007	200	Grommet
8GA 002 073-121	10	P21W bulb, 12V
8GA 002 073-241	10	24V

For flush/surface mounting

Caution: The water drainage opening must be knocked out according to the attachment position!

Black plastic body.

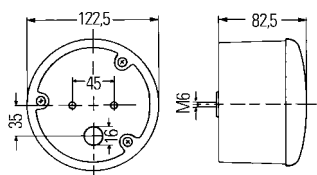

Part no.	Pk.	
		For front flush/surface mounting. Amber indicator light, clear position light. With grommet.
2BE 964 169-071	1	Indicator-position light with two M6 x 25 fixing screws
2BE 964 169-077	20	
		Spare parts/Accessories:
9EL 964 533-001	1	Lens with screws
9GT 341 438-007	200	Grommet
8GA 002 071-121	10	R5W bulb, 12V
8GA 002 071-241	10	24V
8GA 002 073-121	10	P21W bulb, 12V
8GA 002 073-241	10	24V
		Clear lens. With grommet.
		Reverse light with two M6 x 25 fixing screws
2ZR 964 169-031	1	
2ZR 964 169-037	20	
		Reverse light without fixing screws
		Clear lens. With grommet, 160 mm lead, blade terminals and 12V bulb.
		Reverse light with two M6 x 25 fixing screws
2ZR 964 169-107	20	
		Spare parts/Accessories:
9EL 964 529-001	1	Lens with screws
9GT 341 438-007	200	Grommet
		P21W bulb, 12V
8GA 002 073-121	10	24V
8GA 002 073-241	10	

For surface mounting

EuroLED

In LED-technology. With 1 Power-LED.

Firmly sealed with black base plate.

Electrical connection by means of a 2500 mm long lead.

Two 5.3 mm dia. holes for fixing screws.

Voltage range: 9V - 33V.

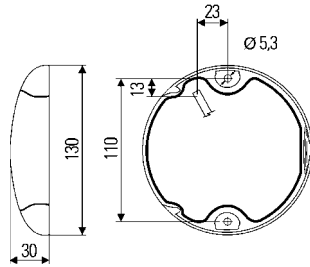

Part no.	Pk.	
		Red lens. Consumption: 0.21A at 12V, 0.10A at 24V. See LED instruction 2.
2SB 959 821-601	1	Tail-stop light, 2.5W
		Amber lens. Consumption: 0.21A at 12V, 0.10A at 24V. See LED instruction 3.
2BA 959 822-601	1	Indicator light, 2.5W
		Clear lens. Consumption: 0.33A at 12V, 0.17 at 24V. See LED instruction 2.
2NE 959 821-201	1	Rear fog light, 4.0W
		White lens. Consumption: 0.21A at 12V, 0.10A at 24V. See LED instruction 2.
2ZR 959 820-601	1	Reverse light, 2.5W
		White lens. Consumption: 0.33A at 12V, 0.17A at 24V.
2JA 959 820-501	1	Interior light, 4.0W

EuroLED Touch

In LED-technology. Clear lens.

With 1 white and 8 red LEDs.

Consumption: 0.25A at 12V, 0.13A at 24V.

With sensitive switch, for on/off and dimming function, also change between white and red night light. With 2500 mm long lead.

Two 5.3 mm dia holes for fixing screws.

Voltage range: 9V - 33V.

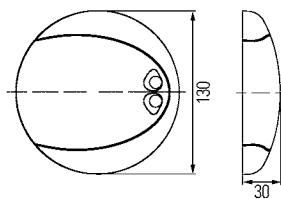

Part no.	Pk.	
2JA 959 950-031	1	Interior light, 3.0W, with black cover plate
2JA 959 950-017	12	
2JA 959 950-041	1	with white cover plate

For flush mounting

Chrome-plated rim. Rubber body. Mounting depth 45 mm.
Three M4 fixing screws. Bulb holder with vibration damping.

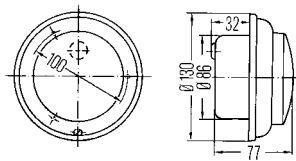

Part no.	Pk.	
		Red lens. Two lights can be fitted next to each other.
2SB 001 240-311	1	Rear-stop light (only for spare parts requirement)
		Spare parts/Accessories:
9EM 128 230-001	1	Lens with rim and reflector
8GA 002 071-131	10	R10W bulb,
8GA 002 071-251	10	12V
		24V
8GA 002 073-121	10	P21W bulb,
8GA 002 073-241	10	12V
		24V
		Red lens. Two lights can be fitted next to each other.
2SA 001 240-331	1	Rear light
		Accessories:
8GA 002 071-121	10	R5W bulb,
8GA 002 071-241	10	12V
		24V
		Red lens.
2DA 001 240-341	1	Stop light (only for spare parts requirement)
		Spare parts/Accessories:
9EM 128 229-001	1	Lens with rim and reflector
8GA 002 073-121	10	P21W bulb,
8GA 002 073-241	10	12V
		24V
		Amber lens (category 2a).
2BA 001 240-301	1	Indicator light
		Spare parts/Accessories:
9EM 128 229-011	1	Lens with rim and reflector
8GA 002 073-121	10	P21W bulb,
8GA 002 073-241	10	12V
		24V
		Clear lens.
2ZR 001 240-351	1	Reverse light
		Reverse light with black plastic rim, not resistant to UV-radiation, frame must be covered when installed
2ZR 001 240-377	30	
		Spare parts/Accessories:
9EM 128 244-001	1	Lens with rim and reflector for -351
8GA 002 073-121	10	P21W bulb,
8GA 002 073-241	10	12V
		24V

For vertical flush mounting

AgrolunaLED

In LED-technology. Clear lens.
 With integrated electronic for cancellation control of indicator light.
 12 red LEDs for rear and stop light
 (rear light with reduced power), 12 amber LEDs for indicator light.
 With 4-pole DEUTSCH plug connector.

Two 6 mm dia. holes for fixing screws. Voltage range: 9V - 32V.
 See LED instruction 1, 2, 3.

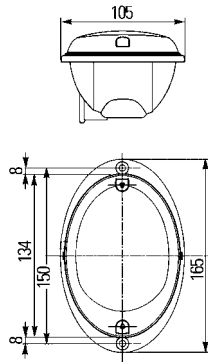

1	indicator
2	rear
3	ground
4	stop



Part no.	Pk.	
		Rear light: 0.5W, stop light: 1.6W, indicator light: 2.0W. Consumption: 0.34A at 12V, 0.17A at 24V.
2SD 343 390-401	1	Rear-stop-indicator light, left and right
2SD 343 390-407	24	

For horizontal or vertical surface mounting

AgrolunaLED

In LED-technology. Clear lens.
 With integrated electronic for cancellation control of indicator light.
 12 red LEDs for rear and stop light
 (rear light with reduced power), 12 amber LEDs for indicator light.
 With 4-pole DEUTSCH plug connector.

Two M6 fixing screws. Voltage range: 9V - 32V.
 Type of protection: IP69. See LED instruction 1, 2, 3.

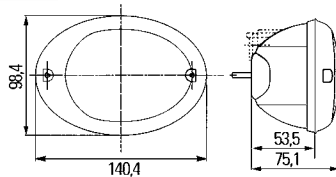

1	indicator
2	rear
3	ground
4	stop



Part no.	Pk.	
		Rear light: 0.5W, stop light: 1.6W, indicator light: 2.0W. Consumption: 0.34A at 12V, 0.17A at 24V.
2SD 343 390-417	1	Rear-stop-indicator light, left and right

For horizontal or vertical surface mounting

AgrolunaLED

In LED-technology. Clear lens.
 With integrated electronic for cancellation control of indicator light.
 12 red LEDs for rear and stop light
 (rear light with reduced power), 12 amber LEDs for indicator light.
 With 100 mm lead.

Two 6 mm dia. holes for fixing screws. Voltage range: 9V - 32V.
 See LED instruction 1, 2, 3.

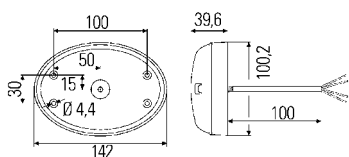

Part no.	Pk.	
2SD 343 390-011	1	Rear light: 0.67W, stop light: 2.5W, indicator light: 2.9W. Consumption: 0.5A at 12V, 0.25A at 24V.
		Rear-stop-indicator light, left and right
2SB 343 390-091	1	Rear light: 0.5W, stop light 2.4W. Consumption: 0.24A at 12V, 0.12A at 24V.
		Rear-stop light, left and right
2BA 343 390-071	1	Indicator light: 3.2W. Consumption: 0.26A at 12V, 0.13A at 24V.
		Indicator light, left and right

For vertical flush mounting

Agroluna

With 4-pole DEUTSCH plug connector.

Two 6 mm dia. holes for fixing screws.

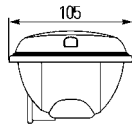

1	indicator
2	rear
3	ground
4	stop

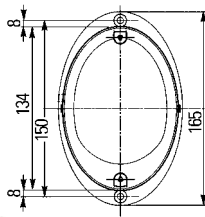

1	free
2	free
3	ground
4	indicator



1	indicator
2	free
3	ground
4	side



1	free
2	free
3	ground
4	Reverse

Part no.	Pk.	
		Red rear and stop light, amber indicator light. With 12V bulbs.
2SD 343 130-377	24	Rear-stop-indicator light, left and right
		Spare parts/Accessories: P21/5W bulb, 12V
8GD 002 078-121	10	12V
8GD 002 078-241	10	24V
8GA 002 073-121	10	P21W bulb, 12V
8GA 002 073-241	10	24V
		Red rear and stop light, amber indicator light. With 24V HD bulb.
2SD 343 130-337	24	Rear-stop-indicator light, left and right
		Spare parts: 1 Lens 10 P21/5W HD bulb, 24V 10 P21W HD bulb, 24V
9EL 343 135-011	1	Lens
8GD 002 078-011	10	P21/5W HD bulb, 24V
8GA 002 073-251	10	P21W HD bulb, 24V
		Amber lens. With 12V bulb.
2BA 344 130-747	24	Indicator light, left and right
		Spare parts: 1 Lens 10 P21W bulb, 12V
9EL 343 134-011	1	Lens
8GA 002 073-121	10	P21W bulb, 12V
		Amber indicator light, white position light. With 12V bulb.
2BE 344 130-777	24	Indicator-position light
		Spare parts: 1 Lens 10 P21W bulb, 12V 10 R10W bulb, 12V
9EL 343 135-001	1	Lens
8GA 002 073-121	10	P21W bulb, 12V
8GA 002 071-121	10	R10W bulb, 12V
		Clear lens. With 12V bulb.
2ZR 343 130-387	24	Reverse light, left and right
		Spare parts: 1 Lens 10 P21W bulb, 12V
9EL 343 134-051	1	Lens
8GA 002 073-121	10	P21W bulb, 12V

For horizontal flush mounting

Agroluna

Two 6 mm dia. holes for fixing screws.



1	indicator
2	rear
3	ground
4	stop

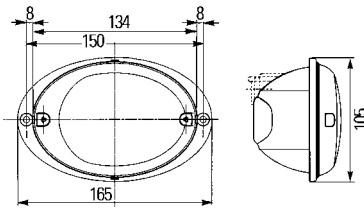

1	free
2	rear fog
3	ground
4	free

Part no.	Pk.	
		Rear-stop-indicator light, with 4-pole DEUTSCH plug connector and 12V bulbs.
2SD 343 130-737	24	Rear-stop-indicator light, left
2SD 343 130-747	24	Rear-stop-indicator light, right
		Red rear and stop light, amber indicator light. With grommet and 24V HD bulbs.
2SD 343 130-397	24	Rear-stop-indicator light, left
2SD 343 130-227	24	Rear-stop-indicator light, right
		Spare parts:
9EL 343 135-011	1	Lens
8GA 002 073-121	10	P21W bulb, 12V
8GA 002 073-251	10	P21W HD bulb, 24V
8GD 002 078-121	10	P21/5W bulb, 12V
8GD 002 078-011	10	P21/5W HD bulb, 24V
		Red lens. With grommet, 12V bulb and 120 mm lead with 6.3 mm blade terminals.
2DA 343 130-257	24	Stop light with 12V bulbs, left
2DA 343 130-267	24	Stop light with 12V bulbs, right
2DA 344 130-617	24	Stop light with 24V bulbs, left
2DA 344 130-607	24	Stop light with 24V bulbs, right
		Red lens. With grommet, 12V bulb and 100 mm lead with 6.3 mm blade terminals.
2NE 343 130-277	24	Rear fog light, left
2NE 343 130-287	24	Rear fog light, right
		Red lens. With 4-pole DEUTSCH plug connector and 12V bulb.
2NE 343 130-177	30	Rear fog light, left
		Spare parts:
9EL 343 134-061	1	Lens for 2DA
9EL 343 134-041	1	Lens for 2NE
8GA 002 073-121	10	P21W bulb, 12V
8GA 002 073-241	10	P21W bulb, 24V

For horizontal flush mounting

Agroluna

Two 6 mm dia. holes for fixing screws.



1	indicator
2	free
3	ground
4	position

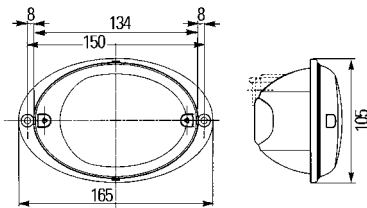

Part no.	Pk.	
		Amber indicator light, clear position light. With 4-pole DEUTSCH plug connector and 12V bulbs.
2BE 343 130-657	24	Indicator-position light, left
2BE 343 130-667	24	Indicator-position light, right
		Amber indicator light, clear position light. With grommet, without bulbs.
2BE 343 130-777	24	Indicator-position light, left
2BE 343 130-787	24	Indicator-position light, right
		Spare parts/Accessories:
9EL 343 135-001	1	Lens
8GA 002 071-131	10	R10W bulb, 12V
8GA 002 073-121	10	P21W bulb, 12V
		Amber lens. With grommet, 100 mm lead and 6.3 mm blade terminals.
2BA 343 130-297	24	Indicator light with 12V bulbs, left
2BA 343 130-307	24	Indicator light with 12V bulbs, right
2BA 343 130-537	24	Indicator light with 24V bulbs, left
2BA 343 130-547	24	Indicator light with 24V bulbs, right
		Spare parts:
9EL 343 134-011	1	Lens
8GA 002 073-121	10	P21W bulb, 12V
8GA 002 073-241	10	24V
		Clear lens. With grommet, 12V bulbs and 120 mm lead with 6.3 mm blade terminals.
2ZR 343 130-317	24	Reverse light, left
2ZR 343 130-327	24	Reverse light, right
		Spare parts:
9EL 343 134-051	1	Lens
8GA 002 073-121	10	P21W bulb, 12V
8GA 002 073-241	10	24V

For horizontal surface mounting

Agroluna

Black plastic body.
Two M5 x 40 fixing screws, distance between screws: 50 mm,
for side (mirror) mounting.

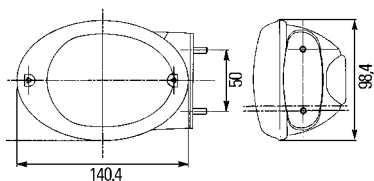

Part no.	Pk.	
		Red rear and stop light, amber indicator light.
2SD 343 130-797	30	Rear-stop-indicator light, left
2SD 343 130-807	30	Rear-stop-indicator light, right
		Spare parts/Accessories:
9EL 343 135-011	1	Lens
8GD 002 078-121	10	12V
8GD 002 078-241	10	24V
		P21W bulb,
8GA 002 073-121	10	12V
8GA 002 073-241	10	24V
		Amber indicator light, clear position light. With 12V bulbs.
2BE 343 130-417	30	Indicator-position light, left
2BE 343 130-427	30	Indicator-position light, right
		Spare parts:
8GA 002 071-131	10	R10W bulb, 12V
8GA 002 073-121	10	P21W bulb, 12V

For horizontal or vertical flush/surface mounting

Agroluna



Caution: The water drainage opening must be knocked out according to the attachment position!
Please refer to the installation instructions.

Two M6 x16 fixing screws.



1	indicator
2	rear
3	ground
4	stop

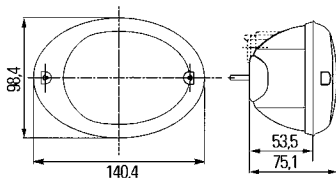

1	free
2	rear
3	ground
4	stop



Part no.	Pk.	
		Red rear and stop light, amber indicator light. With grommet.
2SD 343 130-011	1	Rear-stop-indicator light, 12V/24V
2SD 343 130-017	30	
		Red rear and stop light, amber indicator light. With 4-pole DEUTSCH plug connector and 12V bulbs.
2SD 343 130-071	1	Rear-stop-indicator light
		For horizontal mounting. Red rear and stop light, amber indicator light. With 4-pole DEUTSCH plug connector and 12V bulbs.
2SD 343 130-157	30	Rear-stop-indicator light, left
2SD 343 130-167	30	Rear-stop-indicator light, right
		For horizontal mounting. Red rear and stop light, amber indicator light. With 4-pole DEUTSCH plug and 24V bulbs.
2SD 343 130-137	30	Rear-stop-indicator light, left
2SD 343 130-147	30	Rear-stop-indicator light, right
		Spare parts/Accessories:
9EL 343 135-011	1	Lens
8GD 002 078-121	10	12V
8GD 002 078-241	10	24V
8GA 002 073-121	10	12V
8GA 002 073-241	10	24V
		Red lens, with grommet
2SB 343 130-027	30	Rear-stop light
		Red lens. With 4-pole DEUTSCH plug connector and 12V bulbs.
2SB 343 130-757	30	Rear-stop light, left
2SB 343 130-767	30	Rear-stop light, right
		Spare parts/Accessories:
9EL 343 134-021	1	Lens
8GD 002 078-121	10	12V
8GD 002 078-241	10	24V
		Red lens, with grommet
2NE 343 130-031	1	Rear fog light
2NE 343 130-037	30	
		Spare parts:
9EL 343 134-041	1	Lens
8GA 002 073-121	10	12V
8GA 002 073-241	10	24V

For horizontal or vertical flush/surface mounting

Agroluna



Caution: The water drainage opening must be knocked out according to the attachment position!
Please refer to the installation instructions.

Two M6 x16 fixing screws.

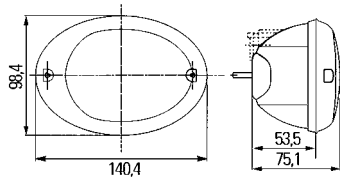

Part no.	Pk.	
		Amber indicator light, clear position light. With grommet.
2BE 343 130-001	1	Indicator-position light, 12V/24V, distance between fixing screws: 45 mm
2BE 343 130-007	30	
2BE 343 130-081	1	Indicator-position light, 12V/24V, distance between fixing screws: 58 mm
		Spare parts/Accessories:
9EL 343 135-001	1	Lens
8GA 002 071-131	10	R10W bulb, 12V
8GA 002 071-251	10	24V
8GA 002 073-121	10	P21W bulb, 12V
8GA 002 073-241	10	24V
		Amber lens, with grommet.
2BA 343 130-051	1	Indicator light
2BA 343 130-057	30	
		Amber lens. With 4-pole DEUTSCH plug connector and 12V bulbs.
2BA 343 130-577	30	Indicator light, left
2BA 343 130-587	30	Indicator light, right
		Spare parts:
9EL 343 134-011	1	Lens
8GA 002 073-121	10	12V
8GA 002 073-241	10	24V
		Clear lens. With grommet.
2ZR 343 130-041	1	Reverse light
2ZR 343 130-047	30	
		Clear lens. With 4-pole DEUTSCH plug connector and 12V bulb.
2ZR 343 130-607	30	Reverse light, right
		Spare parts/Accessories:
9EL 343 134-051	1	Lens
8GA 002 073-121	10	P21W bulb, 12V
8GA 002 073-241	10	24V

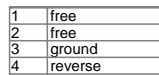
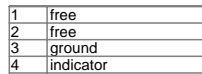

For rear surface mounting

Two M5 fixing screws.

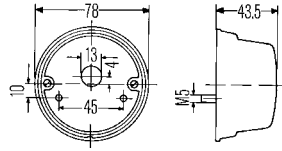

Part no.	Pk.	
		Red rear light, amber stop (indicator) light. National type test for Germany.
2SB 001 259-261	2	Rear-stop-(indicator) light
		Red rear light, amber stop (indicator) light, with illumination for 340 x 240 mm and 240 x 130 mm licence plates with 0°, 15° and 30° inclination. National type test for Germany.
2ST 001 259-321	2	Rear-stop-(indicator)-licence plate light
		Spare parts/Accessories:
9EL 088 525-001	2	Lens with screws for -261
9FT 088 047-001	10	Bulb holder K bulb,
8GM 002 091-131	10	12V10W
8GM 002 091-121	10	12V18W
		Adapter for surface-mounting to bodywork surfaces inclined at 45°. For 001 259-261/-321
8HG 002 247-001	2	
		Red lens Two lights can be fitted next to each other.
2SA 001 259-751 2SA 001 259-757	2 90	Rear light
		Spare parts/Accessories:
9EL 135 266-001	2	Lens with screws
9FT 088 047-001	10	Bulb holder
8GM 002 092-121	10	C5W bulb, 12V
		Red lens. With illumination for 340 x 240 mm, 240 x 130 mm and 520 x 120 mm licence plates. National type test for Germany.
2TF 001 259-761	2	Rear-licence plate light
		Spare parts/Accessories:
9FT 088 047-001	10	Bulb holder
8GM 002 091-131	10	K bulb, 12V10W

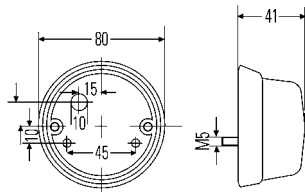
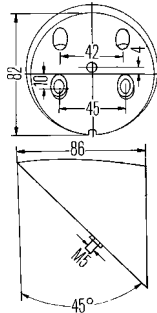

For front surface mounting

Two M5 fixing screws.

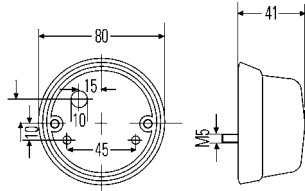

Part no.	Pk.	
2PF 001 259-631	2	Clear lens.
9EL 109 208-011	2	Position light
9FT 088 047-001	10	Spare parts/Accessories:
8GM 002 092-121	10	2 Lens with screws
		10 Bulb holder
		10 C5W bulb, 12V
		Green lens.
		Vehicles whose trailers are equipped with ABS and do not yet have plug connectors to ISO 3731 (24S), ISO 7683 or ISO 1185 (24N) are required to equip the trailer with a green position light located in the field of vision of the outside mirror on the driver side for indicating the function of the ABS.
2PF 001 259-677	108	Position light
9FT 088 047-001	10	Spare parts/Accessories:
8GM 002 092-121	10	10 Bulb holder
		10 C5W bulb, 12V
		Amber indicator light, white position light.
		National type test for Germany.
2BE 001 259-061	2	Indicator-position light
9EL 088 538-001	2	Spare parts/Accessories:
9FT 088 047-001	10	2 Lens with screws
8GM 002 091-121	10	10 Bulb holder
8GM 002 094-121	10	10 K bulb, 12V
		10 M bulb, 12V
8HG 002 247-001	2	Adapter for surface-mounting to bodywork surfaces inclined at 45°, for 001 259-061

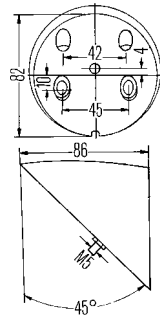
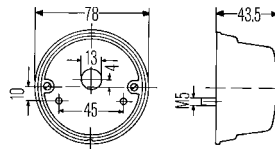

For front or rear surface mounting

Two M5 fixing screws.

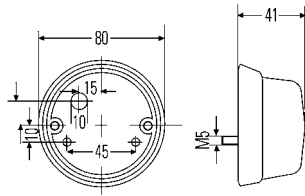

Part no.	Pk.	
		Amber lens (category 1 and 2a). National type test for Germany.
		Indicator light for front or rear surface mounting
2BA 001 259-611	2	
2BA 001 259-618	90	
		Spare parts/Accessories:
9EL 088 150-001	2	Lens with screws
9FT 088 047-001	10	Bulb holder
8GM 002 091-121	10	K bulb, 12V
		Clear lens.
2ZR 001 421-101	4	Reverse light
		Accessories:
8GM 002 091-181	10	C21W bulb, 12V

For horizontal or vertical surface mounting

Plastic base plate.
Two holes for M5 fixing screws.

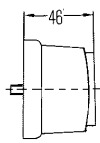
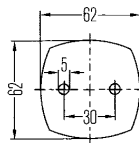
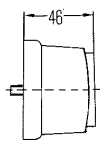
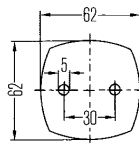
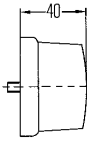
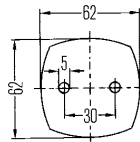
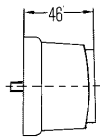
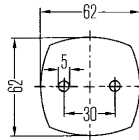
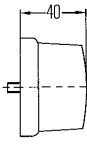
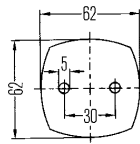

Part no.	Pk.	
		Red lens. Black base plate. Two lights can be fitted next to each other.
2SA 003 057-021	1	Rear light
		Red lens.
2TM 003 057-031	1	Rear light with reflector (only for spare parts requirement)
		Spare parts/Accessories:
9EL 117 330-011	2	Lens for -021 C5W bulb,
8GM 002 092-121	10	12V
8GM 002 092-241	10	24V
		For front mounting. Clear lens.
2PF 003 057-001	1	Position light with white base plate
2PF 003 057-002	1	Position light with white base plate Pro-fit pack
2PF 003 057-041	1	Position light with black base plate
2PG 003 057-011	1	Position light with reflector and white base plate
2PG 003 057-067	1	Position light with reflector and black base plate
		Spare parts/Accessories:
		Lens
9EL 117 330-001	2	for -001/-002/-041
9EL 117 334-001	2	for -011/-012/-067
		C5W bulb,
8GM 002 092-121	10	12V
8GM 002 092-241	10	24V
		Amber lens. With white base plate.
2PS 003 057-051	1	Side-marker light with reflector
2PS 003 057-057	60	
2PS 003 057-052	1	Side-marker light with reflector Pro-fit pack
		Spare parts/Accessories:
		Lens
		C5W bulb,
8GM 002 092-121	10	12V
8GM 002 092-241	10	24V

For horizontal surface mounting

Plastic base plate.
Two holes for M5 fixing screws.

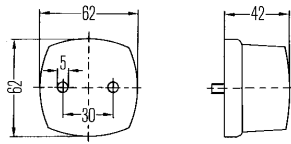

Part no.	Pk.	Description
2PF 004 081-001	2	For front mounting. Clear lens. Vertical attachment tolerance: + 15°/- 30°.
2PF 004 081-007	50	Position light with black base plate
2PF 004 081-017	50	Position light with white base plate

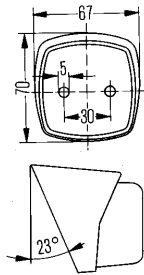

2PF 004 081-107	1	For front mounting. Clear lens. For mounting on surfaces inclined at 23°.
2PF 004 081-117	1	Position light with black base plate
		Position light with white base plate
		Accessories: C5W bulb, 8GM 002 092-121 10 12V 8GM 002 092-241 10 24V

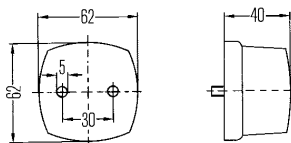

		For horizontal rear/side surface mounting Front lens clear, rear lens red. Black base plate.
2XS 005 639-001	24	Clearance light
2XS 005 639-002	1	Clearance light Pro-fit pack
		Accessories: C5W bulb, 8GM 002 092-121 10 12V 8GM 002 092-241 10 24V

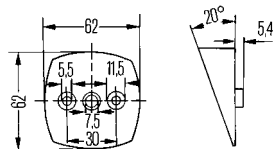

9XD 127 264-007	50	Adapter white, for surface mounting of lights in model ranges 2PF 004 081-... and 2PF 003 057-... to body work surfaces inclined at 20°
		Adapter

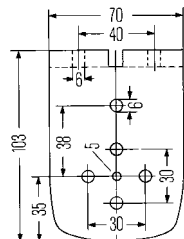

8HG 003 799-001	2	Holder, black, for position lights in model ranges 2PF 003 057-..., 2PF 004 081-... or reflectors in model ranges 8RA 002 014-... and 8RA 002 015-...
8HG 003 799-007	100	Rubber holder
8HG 003 799-017	1	Hard rubber holder

For horizontal or vertical surface mounting

Black plastic base plate.
Two holes for M4 fixing screws. With grommet.

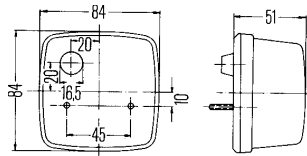

Part no.	Pk.	
2SB 003 014-151	2	Red lens.
9EL 115 003-035	2	Rear-stop light
		Spare parts: Lens with screws
		Red lens, with illumination for 340 x 240 mm and 240 x 130 mm licence plates (above licence plates), or mounting to right and left of 520 x 120 mm licence plate
2ST 003 014-141	2	Rear-stop-licence plate light
9EL 115 003-021	2	Spare parts: Lens with screws
		Red rear light, amber indicator light.
2SW 003 014-131	2	Rear-indicator light
9EL 115 003-011	2	Spare parts: Lens with screws
		Red rear light, amber indicator light, with illumination for 340 x 240 mm and 240 x 130 mm licence plates (above licence plates), or mounting to right and left of 520 x 110 mm licence plate
2SY 003 014-121	2	Rear-indicator-licence plate light
9EL 115 003-001	2	Spare parts/Accessories: Lens with screws C5W bulb,
8GM 002 092-121	10	12V
8GM 002 092-241	10	24V P21W bulb,
8GA 002 073-121	10	12V
8GA 002 073-241	10	24V
		For horizontal surface mounting. Red lens. Two lights can be fitted next to each other.
2SA 003 014-051	2	Rear light
9EL 110 540-001	1	Spare parts/Accessories: Lens with screws C5W bulb,
8GM 002 092-121	10	12V
8GM 002 092-241	10	24V
		For horizontal surface mounting. Red lens
2DA 003 014-031	2	Stop light
2DA 003 014-037	36	
8GA 002 073-121	10	Accessories: P21W bulb, 12V
8GA 002 073-241	10	24V

For horizontal surface mounting

Black plastic base plate.
Two holes for M4 fixing screws. With grommet.

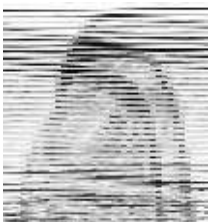
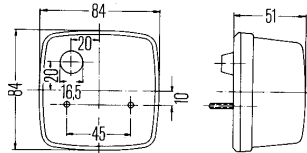

Part no.	Pk.	
		Clear lens.
2PF 003 014-071	2	Position light for front mounting
		Spare parts/Accessories:
9EL 110 542-001	3	Lens with screws
8GM 002 092-121	10	C5W bulb, 12V
8GM 002 092-241	10	24V
		Green lens.
		Vehicles whose trailers are equipped with ABS and do not yet have plug connectors to ISO 3731 (24S), ISO 7683 or ISO 1185 (24N) are required to equip the trailer with a green position light located in the field of vision of the outside mirror on the driver side for indicating the function of the ABS.
2PF 003 014-301	1	Position light
		Accessories:
8GA 002 073-121	10	P21W bulb, 12V
8GA 002 073-241	10	24V
		Amber indicator light, white position light.
2BE 003 014-251	2	Indicator-position light for front mounting
2BE 003 014-257	36	
		Spare parts/Accessories:
9EL 115 003-055	2	Lens with screws
8GM 002 092-121	10	C5W bulb, 12V
8GM 002 092-241	10	24V
8GA 002 073-121	1	P21W bulb, 12V
8GA 002 073-241	10	24V
		Amber lens.
2BA 003 014-111	2	Indicator light for front mounting (category 1)
2BA 003 014-011	2	Indicator light for rear mounting (category 2a)
		Spare parts/Accessories:
9EL 110 536-011	3	Lens with screws for -111
9EL 110 536-001	1	for -011
8GA 002 073-121	10	P21W bulb, 12V
8GA 002 073-241	10	24V
		Clear lens.
2ZR 003 014-091	2	Reverse light
		Accessories:
8GA 002 073-121	10	P21W bulb, 12V
8GA 002 073-241	10	24V

For horizontal surface mounting

Black plastic body.
Two M5 fixing screws. With grommet.

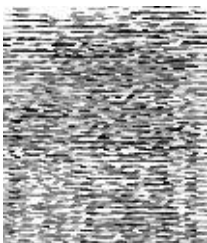
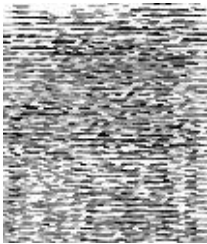
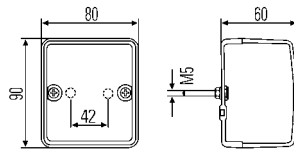

Part no.	Pk.	
2SA 996 012-091	2	Red lens. Rear light
9EL 990 034-051	1	Spare parts/Accessories: Lens
8GA 002 071-131	10	R10W bulb,
8GA 002 071-251	10	12V
		24V
2DA 996 012-041	2	Red lens. Stop light
2NE 996 012-021	2	Red lens. With 2 rubber spacers for 8° or 12° inclination. Rear fog light
8GA 002 073-121	10	Accessories: P21W bulb,
8GA 002 073-241	10	12V
		24V
2PF 996 012-051	2	Clear lens. Position light
8GA 002 071-121	10	Accessories: R5W bulb,
8GA 002 071-241	10	12V
		24V
2BA 996 012-061	2	For rear or front surface mounting. Amber lens. Indicator light
2BA 996 012-071	1	Indicator light with rubber spacer for 8° inclination
2BA 996 012-147	45	Indicator light with PMMA lens, 24V bulb, 500 mm lead and plug
2ZR 996 012-111	2	Clear lens. Reverse light with 2 rubber spacers for 8° or 12° inclination
2ZR 996 012-101	1	Reverse light without rubber spacers
2JB 996 012-121	1	Boot light with switch and rubber spacers
9EL 990 034-041	1	Spare parts/Accessories: Lens
9EL 990 122-001	1	for 2BA ... for 2ZR/2JB ...
8GA 002 073-121	10	P21W bulb,
8GA 002 073-241	10	12V
		24V

For horizontal or vertical flush/surface mounting

Black plastic body. Two M6 fixing screws.

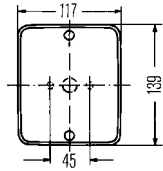

Part no.
2SA 003 236-041
2SA 003 236-047
2SA 003 236-048

Pk.
 1
 6
 48

Red lens.
Rear light

9EL 120 201-001
 8GA 002 071-121
 8GA 002 071-241

4
 10
 10

Spare parts/Accessories:
 Lens
 R5W bulb,
 12V
 24V



2DA 003 236-031
2DA 003 236-037

1
 6

Red lens.
Stop light

9EL 119 544-031
 8GA 002 073-121
 8GA 002 073-241

4
 10
 10

Spare parts/Accessories:
 Lens
 P21W bulb,
 12V
 24V



2NE 003 236-001
2NE 003 236-008

1
 48

Red lens.
Rear fog light

9EL 119 544-001
 9DX 119 545-011
 8GA 002 073-121
 8GA 002 073-241

1
 2
 10
 10

Spare parts/Accessories:
 Lens
 Reflector
 P21W bulb,
 12V
 24V



2BA 003 236-021
2BA 003 236-027

1
 6

Amber lens.
Indicator light for rear (category 2a)
or (as auxiliary light)
side mounting (category 5)



2BA 003 236-177

48

Indicator light for front (category 1)
and side mounting (category 5)

9EL 119 544-021
 8GA 002 073-121
 8GA 002 073-241

4
 10
 10

Spare parts/Accessories:
 Lens for -021/-027
 P21W bulb,
 12V
 24V



2ZR 003 236-051
2ZR 003 236-057

1
 48

Clear lens.
Reverse light

9EL 119 544-111
 9DX 119 545-051
 8GA 002 073-121
 8GA 002 073-241

1
 2
 10
 10

Spare parts/Accessories:
 Lens
 Reflector
 P21W bulb,
 12V
 24V

For horizontal or vertical flush/surface mounting

Black rubber body. Mounting depth: 44 mm.

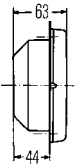
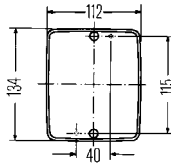

Part no.	Pk.	
2SA 003 236-341	1	Red lens. Two BZ4.2 fixing screws.
	1	Rear light
		Spare parts/Accessories:
9EL 120 201-001	4	Lens
9BG 121 740-001	1	Rubber body
8GA 002 071-121	10	R5W bulb, 12V
8GA 002 071-241	10	R5W bulb, 24V
2DA 003 236-331	1	Stop light
		Spare parts/Accessories:
9EL 119 544-031	4	Lens
9BG 121 740-001	1	Rubber body
8GA 002 073-121	10	P21W bulb, 12V
8GA 002 073-241	10	P21W bulb, 24V
2NE 003 236-301 2NE 003 236-307	1 38	Rear fog light
		Spare parts/Accessories:
9EL 119 544-001	1	Lens
9BG 121 740-001	1	Rubber body
8GA 002 073-121	10	P21W bulb, 12V
8GA 002 073-241	10	P21W bulb, 24V
2BA 003 236-321	1	Indicator light
		Spare parts/Accessories:
9EL 119 544-021	4	Lens
9BG 121 740-001	1	Rubber body
8GA 002 073-121	10	P21W bulb, 12V
8GA 002 073-241	10	P21W bulb, 24V
2BA 003 236-541	1	Indicator-clearance light, also indicator-rear light
		Spare parts/Accessories:
9EL 119 544-212	4	Lens with screws
8GA 002 071-131	10	R10W bulb, 12V
8GA 002 071-251	10	R10W bulb, 24V
8GA 002 073-121	10	P21W bulb, 12V
8GA 002 073-241	10	P21W bulb, 24V
2ZR 003 236-311	1	Reverse light
		Spare parts/Accessories:
9EL 119 544-111	1	Lens
9BG 121 740-001	1	Rubber body
8GA 002 073-121	10	P21W bulb, 12V
8GA 002 073-241	10	P21W bulb, 24V

For horizontal or vertical flush/surface mounting

With double reflector for two bulbs.

Black plastic body.
Four 4.2 x 16 fixing screws.

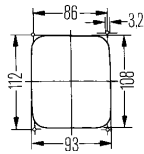
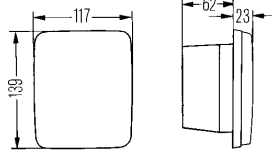

Part no.	Pk.	
Red lens		
2SA 005 200-331	6	Rear light
Spare parts/Accessories:		
9GH 136 698-007	8	Rubber body for additional rear cover
8GA 002 071-131	10	R10W bulb,
8GA 002 071-251	10	12V
		24V
<hr/>		
Red lens.		
2DA 005 200-321	6	Stop light
Spare parts/Accessories:		
9GH 136 698-007	8	Rubber body for additional rear cover
8GA 002 073-121	10	P21W bulb,
8GA 002 073-241	10	12V
		24V
<hr/>		
Amber lens (category 2a).		
2BA 005 200-311	6	Indicator light
Spare parts/Accessories:		
9GH 136 698-007	8	Rubber body for additional rear cover
8GA 002 073-121	10	P21W bulb,
8GA 002 073-241	10	12V
		24V
<hr/>		
Clear lens.		
2ZR 005 200-301	1	Reverse light
Spare parts/Accessories:		
9EL 135 717-001	4	Lens with screws
9GH 136 698-007	8	Rubber body for additional rear cover
8GA 002 073-121	10	P21W bulb,
8GA 002 073-241	10	12V
		24V

For horizontal or vertical flush/surface mounting

For surface mounting: two M8 fixing screws.
 For flush mounting: four holes for fixing screws.
 Depth required for flush mounting: 45 mm. Black rubber body.



Part no.	Pk.	
2SD 004 431-011	1	Red rear and stop light, amber indicator light.
		Rear-stop-indicator light
		Spare parts/Accessories:
		Lens
9EL 119 544-101	4	for rear/stop light
9EL 119 544-021	4	for indicator light
		Reflector
9DE 128 658-001	2	for two bulbs
9DE 128 657-001	2	for one bulb
		R10W bulb,
8GA 002 071-131	10	12V
8GA 002 071-251	10	24V
		P21W bulb,
8GA 002 073-121	10	12V
8GA 002 073-241	10	24V

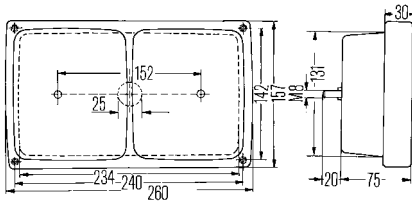

2DB 004 431-061	1	Red stop light, amber indicator light.
		Stop-indicator light
		Spare parts/Accessories:
		Lens
9EL 119 544-031	4	for stop light
9EL 119 544-021	4	for indicator light
9DE 128 657-001	2	Reflector for 1 bulb
		R10W bulb,
8GA 002 071-131	10	12V
8GA 002 071-251	10	24V
		P21W bulb,
8GA 002 073-121	10	12V
8GA 002 073-241	10	24V



2SA 004 431-071	1	Red rear an rear fog light.
		2 bulbs for rear light.
		Rear-rear fog light
		Spare parts/Accessories:
		Lens for rear fog light
9EL 119 544-001	1	R10W bulb,
		12V
8GA 002 071-131	10	24V
8GA 002 071-251	10	P21W bulb,
		12V
8GA 002 073-121	10	24V
8GA 002 073-241	10	

For horizontal or vertical flush/surface mounting

For surface mounting: two M8 fixing screws.
 For flush mounting: four holes for fixing screws.
 Depth required for flush mounting: 45 mm. Black rubber body.

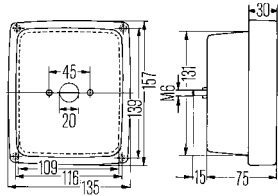

Part no.	Pk.	
		Red lens.
2NE 004 432-011	1	Rear fog light
		Spare parts/Accessories:
9EL 119 544-001	1	Lens
8GA 002 073-121	10	P21W bulb, 12V
8GA 002 073-241	10	24V
		Clear lens.
2ZR 004 432-001	1	Reverse light
		Spare parts/Accessories:
9EL 119 544-111	1	Lens
8GA 002 073-121	10	P21W bulb, 12V
8GA 002 073-241	10	24V

For vertical flush mounting

In LED-technology. With 32 LEDs.
 Grey plastic body.
 With 100 mm lead and Superseal plug.

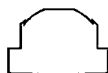
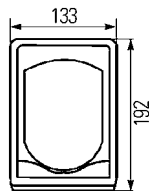

Part no.	Pk.	
		Red light. Clear lens with optical pattern. Consumption: 0.25A at 12V. See LED instruction 2.
2SB 008 982-207	36	Rear-stop light, 12V3.0W
		For front mounting. Amber light. Clear lens with optical pattern. With failure check for LED indicators. Consumption: 0.17A at 12V. See LED instruction 3.
2BA 008 982-217	36	Indicator light, 12V2.0W

For horizontal flush mounting

In LED-technology. With 32 LEDs.

Grey plastic body.

With 450 mm lead with stripped cable ends.

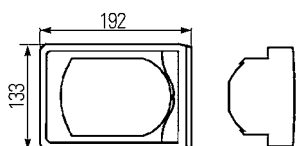

Part no.	Pk.	
		Red lens, without optical pattern. Consumption: 0.25A at 12V, 0.13A at 24V. See LED instruction 2.
2SB 008 982-301	1	Rear-stop light, 12V3.0W
2SB 008 982-307	36	
2SB 008 982-001	1	Rear-stop light, 24V3.0W
2SB 008 982-007	36	
<hr/>		
		Red light. Clear lens, without optical pattern. Consumption: 0.25A at 12V. See LED instruction 2.
2SB 008 982-367	36	Rear-stop light, 12V3.0W
<hr/>		
For front mounting. Amber light. Clear lens without optical pattern. With failure check for LED indicators. Consumption: 0.17A at 12V, 0.08A at 24V. See LED instruction 3.		
2BA 008 982-341	1	Indicator light, 12V3.0W
2BA 008 982-347	36	
2BA 008 982-041	1	Indicator light, 24V2.0W
2BA 008 982-047	36	

For horizontal flush mounting

Grey plastic body, with optical pattern.

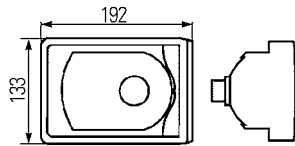

Part no.	Pk.	
		Red lens, without optical pattern.
2SB 008 805-021	1	Rear-stop light
2SB 008 805-027	36	
		Accessories:
8GD 002 078-121	10	P21/5W bulb, 12V
8GD 002 078-241	10	24V
9GD 159 740-007	1	Self-adhesive gasket, black
		Red lens, without optical pattern.
2SA 008 805-001	1	Rear light
2SA 008 805-007	36	
		Accessories:
8GA 002 071-121	10	R5W bulb, 12V
8GA 002 071-241	10	24V
9GD 159 740-007	1	Self-adhesive gasket, black
		Red lens, without optical pattern.
2DA 008 805-011	1	Stop light
2DA 008 805-017	36	
		Accessories:
8GA 002 073-121	10	P21W bulb, 12V
8GA 002 073-241	10	24V
9GD 159 740-007	1	Self-adhesive gasket, black
		For rear or front mounting. Clear lens, without optical pattern.
2BA 008 805-051	1	Indicator light
2BA 008 805-057	36	
		Accessories:
8GA 006 841-121	10	PY21W bulb, 12V
8GA 006 841-241	10	24V
9GD 159 740-007	1	Self-adhesive gasket, black
		For rear or front mounting. Amber lens, without optical pattern.
2BA 008 805-187	36	Indicator light
		Red lens, without optical pattern.
2NE 008 805-031	1	Rear fog light
2NE 008 805-037	36	
		Clear lens, without optical pattern.
2ZR 008 805-041	1	Reverse light
2ZR 008 805-047	36	
		Accessories:
8GA 002 073-121	10	P21W bulb, 12V
8GA 002 073-241	10	24V
9GD 159 740-007	1	Self-adhesive gasket, black

For horizontal flush mounting

Four holes for B4.2 x 13 fixing screws.

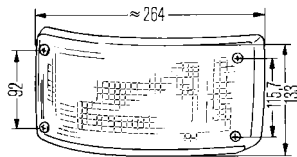

Part no.	Pk.	
		Red lens. (Two lights can be fitted next to each other).
2SA 005 603-021	1	Rear light
2SA 005 603-027	32	
2SA 005 603-227	1	Rear light with PC lens
		Accessories: R5W bulb,
8GA 002 071-121	10	12V
8GA 002 071-241	10	24V
		Red lens.
2SB 005 603-137	1	Rear-stop light
		Accessories: P21/5W bulb,
8GD 002 078-121	10	12V
8GD 002 078-241	10	24V
		Red lens. (Two lights can be fitted next to each other).
2DA 005 603-031	1	Stop light
2DA 005 603-037	32	
2DA 005 603-237	1	Stop light with PC lens
		Red lens
2NE 005 603-071	1	Rear fog light
2NE 005 603-077	32	
		For rear mounting (category 2a). Amber lens.
2BA 005 603-011	1	Indicator light
2BA 005 603-017	32	
2BA 005 603-217	1	Indicator light with PC lens
		For front or side mounting (category 1a and 5). Amber lens.
2BA 005 603-001	1	Indicator light
2BA 005 603-007	32	
		For rear mounting (category 2a). Red lens.
2BA 005 603-117	1	Indicator light with filter
		Clear lens.
2ZR 005 603-061	1	Reverse light
2ZR 005 603-067	32	
		Accessories: P21W bulb,
8GA 002 073-121	10	12V
8GA 002 073-241	10	24V

For horizontal flush mounting

Two holes for B4.2 x 28 fixing screws.

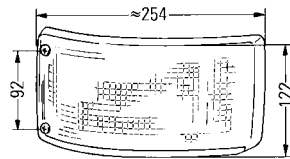

Part no.	Pk.	
		Amber lens.
2BA 004 119-001	1	Indicator light for front mounting (category 1 and 5)
		Accessories:
8GA 002 073-121	10	P21W bulb, 12V
8GA 002 073-241	10	24V
8GA 002 073-251	10	24V (HD)
		Clear lens.
		With base plate and grommet. Can be used only in combination with amber bulb PY21W (not supplied with lamp).
2BA 004 119-017	10	Indicator light for front or side mounting (category 1 and 5)
		Spare parts/Accessories:
9GT 143 133-007	10	Grommet
		PY21W bulb,
8GA 006 841-121	10	12V
8GA 006 841-241	10	24V
		Clear lens.
		With base and two grommets. With amber filter for indicator light.
2BE 004 119-021	1	Indicator-position light for front mounting (category 1 and 5)
		Spare parts/Accessories:
9GT 134 655-007	10	Grommet
9GT 143 133-007	10	
		P21W bulb,
8GA 002 073-121	10	12V
8GA 002 073-241	10	24V
8GA 002 073-251	10	24V (HD)
		W5W bulb,
8GP 003 594-121	10	12V
8GP 003 594-241	10	24V

For horizontal or vertical flush mounting

Two holes for B4.2 x 13 fixing screws. With grommet.

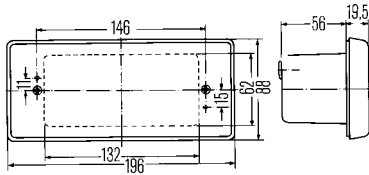

Part no.	Pk.	
2SA 003 734-121	1	Red lens. Two bulbs connected in parallel. (not supplied with lamp).
		Rear light
		Spare parts/Accessories:
9EL 135 060-001	2	Lens with screws
8GA 002 071-121	10	R5W bulb,
8GA 002 071-241	10	12V
		24V
2DA 003 734-011	1	Red lens. For 1 bulb.
		Stop light
		Spare parts/Accessories:
9EL 123 632-001	2	Lens with screws
8GA 002 073-121	10	P21W bulb,
8GA 002 073-241	10	12V
		24V
2NE 003 734-091	1	Red lens. For 1 bulb. For horizontal flush mounting.
		Rear fog light
		Spare parts/Accessories:
8GA 002 073-121	10	P21W bulb,
8GA 002 073-241	10	12V
		24V
2ZR 003 734-041	1	Clear lens. Two bulbs connected in parallel. For horizontal flush mounting.
		Reverse light
		Spare parts/Accessories:
9EL 123 635-001	2	Lens with screws
8GA 002 073-121	10	P21W bulb,
8GA 002 073-241	10	12V
		24V

For horizontal or vertical flush mounting

Two holes for B4.2 x 13 fixing screws. With grommet.

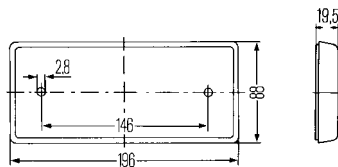
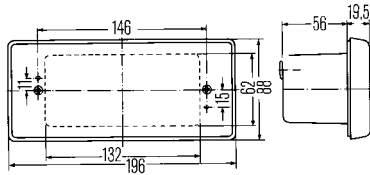

Part no.	Pk.	
2PF 003 734-031	1	<p>Clear lens. Two bulbs connected in parallel. (not supplied with lamp).</p> <p>Position light for front mounting</p> <p>Accessories: R5W bulb, 12V 24V</p>
8GA 002 071-121 8GA 002 071-241	10 10	
2BA 003 734-001	1	<p>Amber lens. Two bulbs connected in parallel. For horizontal flush mounting.</p> <p>Indicator light for rear mounting (category 2a)</p> <p>Spare parts/Accessories: P21W bulb, 12V 24V</p>
8GA 002 073-121 8GA 002 073-241	10 10	
2BA 003 734-061	1	<p>Amber lens. For 1 bulb.</p> <p>Indicator light for front mounting (category 1)</p> <p>Accessories: P21W bulb, 12V 24V</p>
8GA 002 073-121 8GA 002 073-241	10 10	
8RA 003 734-101	1	<p>Red, reflecting surface 54 sq. cm. With rubber base plate. Two B3.9 x 22 fixing screws. For horizontal or vertical surface mounting.</p> <p>Reflector</p>

For horizontal or vertical flush mounting

Plastic base plate.
Two 4 mm dia. holes for fixing screws.

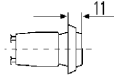
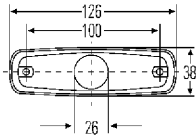

Part no.	Pk.	
		For rear mounting. Red lens, without reflector.
2SA 962 964-091	1	Rear light with 24V bulb and red base plate
		Spare parts/Accessories: W5W bulb,
8GP 003 594-121	10	12V
8GP 003 594-241	10	24V
9GD 963 281-001	1	Gasket
9GT 963 129-001	1	Grommet
		For front mounting. Clear lens, without reflector.
		Position light with 12V bulb and white base plate for wavy outer surfaces
2PF 962 964-061	1	
		Position light with 12V bulb and clear base plate, for flat outer surfaces
2PF 962 964-071	1	
		Clear lens, with reflector.
		Position light with 12V bulb and white base plate for wavy outer surfaces
2PG 962 964-041	1	
		Position light with 12V bulb and clear base plate, for flat outer surfaces
2PG 962 964-051	1	
2PG 962 964-057	160	
		For side mounting. Amber lens, with reflector.
		Side-marker light with 12V bulb and white base plate for wavy outer surfaces
2PS 962 964-031	1	
2PS 962 964-037	160	
		Side-marker light with 12V bulb and clear base plate, for flat outer surfaces
2PS 962 964-012	1	
2PS 962 964-018	160	
		Spare parts/Accessories: W3W bulb,
8GP 003 594-141	10	12V
8GP 003 594-241	10	24V
9GD 963 281-001	1	Gasket
9GT 963 129-001	1	Grommet



For horizontal or vertical surface mounting

Black plastic body.
Two 5 mm dia. holes for fixing screws.

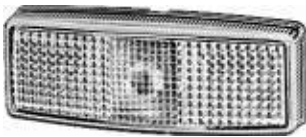
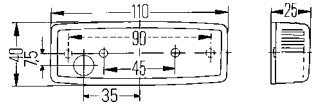

Part no.	Pk.	
For rear mounting. Red lens. ± 10° inclination.		
2SA 006 717-001	1	Rear light
2SA 006 717-007	100	
Spare parts/Accessories:		
9EL 141 135-001	1	Lens
8GP 003 594-121	10	W5W bulb, 12V
2TM 006 717-047		
2TM 006 717-047	1	Rear light with reflector
Accessories:		
8GP 003 594-121	10	W5W bulb, 12V
For front mounting. Clear lens. Can be mounted either vertically or horizontally (± 15° inclination).		
2PF 006 717-011		
2PF 006 717-011	1	Position light
Spare parts/Accessories:		
9EL 141 135-011	20	Lens
8GP 003 594-121	10	W5W bulb, 12V
2PG 006 717-021		
2PG 006 717-021	20	Position light with reflector
2PG 006 717-022		
2PG 006 717-022	100	Position light with reflector Pro-fit-pack
2PG 006 717-022		
2PG 006 717-022	1	Pro-fit-pack
Spare parts/Accessories:		
9EL 141 135-021	20	Lens
8GP 003 594-121	10	W5W bulb, 12V
For side mounting. Amber lens with reflector.		
2PS 006 717-031		
2PS 006 717-031	20	Side-marker light with reflector
2PS 006 717-032		
2PS 006 717-032	100	Side-marker light with reflector Pro-fit-pack
2PS 006 717-032		
2PS 006 717-032	1	Pro-fit-pack
For side mounting. Amber lens.		
2PS 006 717-051		
2PS 006 717-051	8	Side-marker light with reflector, with adhesive foil for fixing
2PS 006 717-057		
2PS 006 717-057	100	Side-marker light with reflector, with adhesive foil for fixing
2PS 006 717-071		
2PS 006 717-071	20	Side-marker light with reflector, with closed fixing holes
2PS 006 717-061		
2PS 006 717-061	1	Side-marker light with reflector, with bracket for fixing below load surface
2PS 006 717-067		
2PS 006 717-067	100	Side-marker light with reflector, with bracket for fixing below load surface
Spare parts/Accessories:		
9EL 141 135-031	1	Lens
8GP 003 594-121	10	W5W bulb, 12V

For horizontal surface mounting

Plastic base plate. Two holes for M5 fixing screws.
With plug connector.

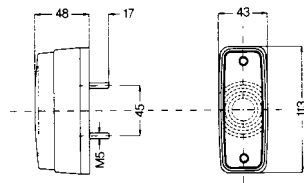

Part no.	Pk.	
2SA 997 027-001	1	Red lens. Only for spare parts requirement.
9EL 997 387-001	1	Rear light
8GM 002 092-121	10	Spare parts/Accessories: Lens with screws
8GM 002 092-121	10	C5W bulb, 12V
8GM 002 092-121	10	24V
2DA 997 027-021	1	Red lens.
8GA 002 073-121	10	Stop light
8GA 002 073-241	10	Accessories: P21W bulb, 12V
8GA 002 073-241	10	24V
2BA 997 027-031	1	For front mounting. Amber lens.
8GA 002 073-121	10	Indicator light
8GA 002 073-241	10	Accessories: P21W bulb, 12V
8GA 002 073-241	10	24V
2PF 997 027-011	1	For front mounting. Clear lens. Only for spare parts requirement.
9EL 997 388-001	1	Position light
8GM 002 092-121	10	Spare parts/Accessories: Lens with screws
8GM 002 092-241	10	C5W bulb, 12V
8GM 002 092-241	10	24V
2JA 997 027-051	1	Clear lens. Chrome-plated body, with switch.
8GM 002 091-121	10	Interior light
8GM 002 091-241	10	Accessories: K bulb, 12V
8GM 002 091-241	10	24V

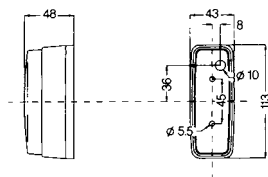

For horizontal surface mounting

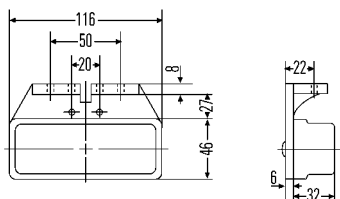
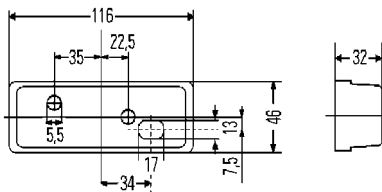
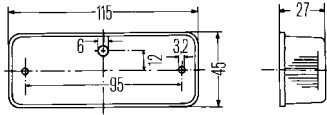

Part no.	Pk.	
		For horizontal or vertical surface mounting Red lens. Black rubber base and two ST4.2 x 32 x 18 fixing screws.
2TM 003 748-011	4	Rear light with reflector
		Accessories: T4W bulb, 12V 24V
8GP 002 067-121 8GP 002 067-241	10 10	
		For front horizontal surface mounting. Clear lens. With black plastic base plate and insert gasket. Two ST4.2 x 16 fixing screws. Type of protection: IP54K and IP59K.
2PG 003 748-151	4	Position light with reflector
		Spare parts/Accessories: Lens T4W bulb, 12V 24V
9EL 148 274-001 8GP 002 067-121 8GP 002 067-241	2 10 10	
		For side horizontal surface mounting. Amber lens. With black plastic base, inserted gasket and reinforced plate, four PT4 x 16 fixing screws and rubber mount.
2PS 003 748-121 2PS 003 748-127	4 80	Side-marker light with reflector
		Spare parts/Accessories: Lens T4W bulb, 12V 24V
9EL 147 910-001 8GP 002 067-121 8GP 002 067-241	2 10 10	
		For side horizontal surface mounting. Amber lens. With black plastic base, inserted gasket and reinforced plate, four PT4 x 16 fixing screws and rubber mount. Type of protection: IP54K and IP59K.
2PS 003 748-161 2PS 003 748-167	4 60	Side-marker light with reflector, holder mounting surfaces points towards the front
		Side-marker light with reflector, holder mounting surfaces points towards the back
2PS 003 748-177	1	
		Spare parts/Accessories: Lens T4W bulb, 12V 24V
9EL 147 910-001 8GP 002 067-121 8GP 002 067-241	2 10 10	

For horizontal or vertical surface mounting

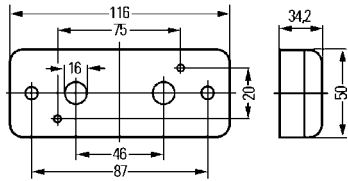

2PS 963 959-001
2PS 963 959-007

Pk.
4
50

For side mounting.
Amber lens.
With 2 PG screw connections.
Side-marker light with reflector

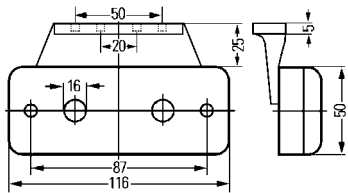

2PS 963 959-011
2PS 963 959-017

4
40

Side-marker light with reflector and rubber bracket

Spare parts/Accessories:

9EL 963 982-001
8GP 002 067-121
8GP 002 067-241
8GP 002 067-261

2
10
10
10

Lens with screws
T4W bulb,
12V
24V
24V (HD)



2PG 963 959-021
2PG 963 959-027

4
50

For front mounting.
Clear lens.
With 1 PG screw connection.

Position light with reflector

Spare parts/Accessories:

9EL 963 983-001
8GP 002 067-121
8GP 002 067-241
8GP 002 067-261

2
10
10
10

Lens with screws
T4W bulb,
12V
24V
24V (HD)



2XS 963 959-031
2XS 963 959-037

4
50

For rear mounting.
Red lens.
With 1 PG screw connection.

Clearance light

Spare parts/Accessories:

9EL 963 984-001
8GP 002 067-121
8GP 002 067-241
8GP 002 067-261

2
10
10
10

Lens with screws
T4W bulb,
12V
24V
24V (HD)

For horizontal or vertical surface mounting

Approved for vehicles carrying hazardous goods when diagonal 98 hole interval is used.

Base plate with black edge. With grommet. Ten 5.5 mm dia. holes for fixing as required.

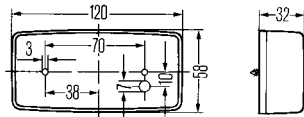
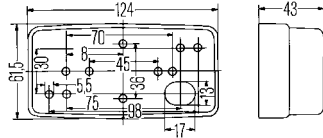

Part no.	Pk.	
		Lens with reflector, red.
2TM 004 361-021	1	Rear light with reflector
		Spare parts/Accessories:
9EL 114 401-041	1	Lens with screws
8GA 002 071-121	10	R5W bulb,
8GA 002 071-241	10	12V
		24V
		Lens with reflector, clear.
		Position light with reflector
2PG 004 361-011	1	
2PG 004 361-017	70	
		Spare parts/Accessories:
9EL 114 401-031	1	Lens with screws
8GA 002 071-121	10	R5W bulb,
8GA 002 071-241	10	12V
		24V
		Lens with reflector, amber.
		Side-marker light with reflector
2PS 004 361-001	1	
2PS 004 361-007	70	
		Spare parts/Accessories:
9EL 114 401-001	1	Lens with screws
8GA 002 071-121	10	R5W bulb,
8GA 002 071-241	10	12V
		24V

Black base plate.
Four 5.5 mm dia. holes for fixing screws.

Part no.	Pk.	
		Lens with reflector, clear.
2PG 002 727-021	5	Position light with reflector
		Spare parts/Accessories:
9EL 114 400-015	1	Lens with screws
8GM 002 092-121	10	C5W bulb,
8GM 002 092-241	10	12V
		24V
		Lens with reflector, amber.
		Side-marker light with reflector
2PS 002 727-001	5	
		Spare parts/Accessories:
9EL 114 401-001	1	Lens with screws
8GM 002 092-121	10	C5W bulb,
8GM 002 092-241	10	12V
		24V

For horizontal surface mounting

In LED-technology. With 2 LEDs.

Two 5.5 mm dia. holes for fixing screws. See LED instruction 2.

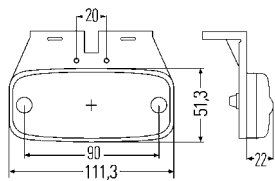
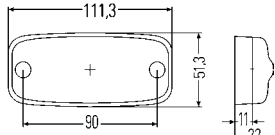

Part no.	Pk.	
		Red lens with reflector. Black base plate. Consumption: 0.02A at 12V, 0.04A at 24V.
2TM 963 639-307	20	Rear light with reflector and 5000 mm lead, 12V0.5W
2TM 963 639-317	1	Rear light with reflector and 5000 mm lead, 24V1.0W
2PG 963 639-401	1	Clear lens with reflector. White base plate. Consumption: 0.02A at 24V.
2PG 963 639-411	1	Position light with reflector and 500 mm lead, 24V0.5W
		Position light with reflector and 5000 mm lead, 24V0.5W
2PS 963 639-001	1	Amber lens with reflector. Black base plate. Consumption: 0.06A at 12V, 0.05A at 24V.
2PS 963 639-007	12	Side-marker light with reflector, without bracket, with 500 mm lead, 12V0.7W
2PS 963 639-011	1	Side-marker light with reflector, without bracket, with 500 mm lead, 24V1.3W
2PS 963 639-017	12	Side-marker light with reflector, without bracket, with 500 mm lead, 24V1.3W
2PS 963 639-207	20	Side-marker light with reflector, without bracket, with 200 mm lead, 24V1.3W
2PS 963 639-137	1	Side-marker light with reflector, without bracket, with 5000 mm lead, 24V1.3W
2PS 963 639-147	1	Side-marker light with reflector, without bracket, with 10000 mm lead, 24V1.3W
2PS 963 639-177	1	Side-marker light with reflector and bracket, with 1500 mm lead and base, 24V1.3W
2PS 963 639-197	1	Side-marker light with reflector, without bracket, with 1500 mm lead and Superseal plug, 24V1.3W
2PS 963 639-061	1	Side-marker light with reflector and bracket, with 500 mm lead, 12V0.7W
2PS 963 639-067	20	Side-marker light with reflector and bracket, with 500 mm lead, 24V1.3W
2PS 963 639-071	1	Side-marker light with reflector and bracket, with 500 mm lead, 24V1.3W
2PS 963 639-077	20	Side-marker light with reflector and bracket, with 1500 mm lead, 24V1.3W
2PS 963 639-167	20	Side-marker light with reflector and bracket, with 1500 mm lead and system plug, 24V1.3W
2PS 963 639-157	1	Side-marker light with reflector and bracket, without lead lead, 24V1.3W
2PS 963 639-127	20	Accessories: Gasket
9GD 341 063-007	20	

For horizontal surface mounting

In LED-technology. With 2 LEDs.

Consumption: 0.05A at 24V.
See LED instruction 2.

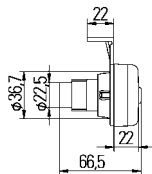
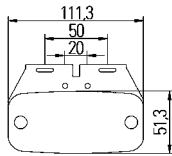
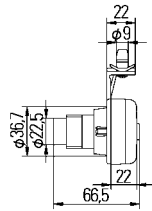
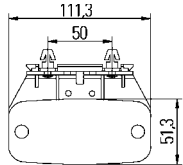

Part no.	Pk.	
		Amber lens with reflector. Black base plate.
2PS 340 001-001	1	Side-marker light with reflector mounted on a holder, with transverse clip angle, front, 24V1.3W
2PS 340 001-011	1	Side-marker light with reflector mounted on a universal holder, angled backwards, 24V1.3W
9XX 340 220-011	10	Accessories: 2-pin connection set

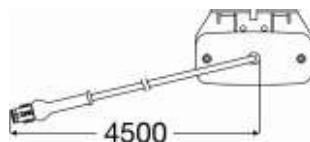
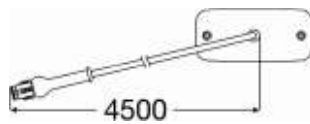
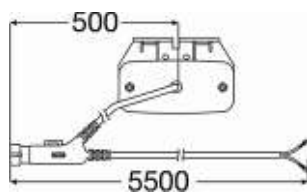
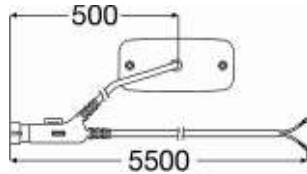
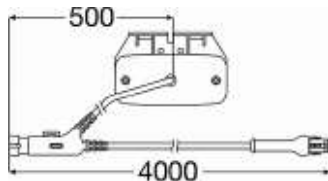
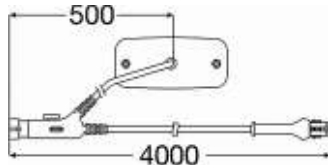
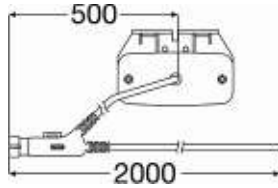
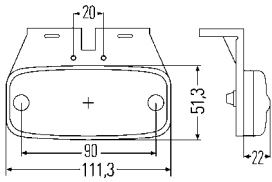
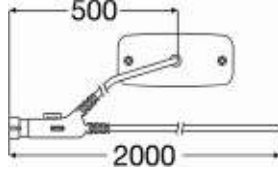
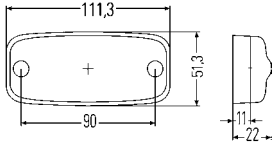

For horizontal surface mounting

In LED-technology. With 2 LEDs.

Consumption: 0.05A at 24V.
Two 5.5 mm dia. holes for fixing screws.
See LED instruction 2.

Part no.	Pk.	
		Amber lens with reflector. Black base plate.
2PS 963 639-101	1	Side-marker light with reflector and 2000/500 mm lead, 24V1.3W
2PS 963 639-111	1	Side-marker light with reflector, 2000/500 mm lead and bracket, angled back, 24V1.3W
2PS 963 639-117	20	
2PS 963 639-041	1	Side-marker light with reflector, 4000/500 mm lead and system plug, 24V1.3W
2PS 963 639-047	20	
2PS 963 639-021	1	Side-marker light with reflector, 4000/500 mm lead, system plug and bracket, angled back, 24V1.3W
2PS 963 639-027	20	
2PS 963 639-081	1	Side-marker light with reflector, 5500/500 mm lead and 6.3 mm blade terminal contact, 24V1.3W
2PS 963 639-091	1	Side-marker light with reflector, 5500/500 mm lead, 6.3 mm blade terminal contact and bracket, angled back, 24V1.3W
2PS 963 639-097	20	
2PS 963 639-051	1	Side-marker light with reflector, 4500 mm lead and system plug, 24V1.3W
2PS 963 639-057	20	
2PS 963 639-031	1	Side-marker light with reflector, 4500 mm lead, system plug and bracket, angled back, 24V1.3W
2PS 963 639-037	20	
9GD 341 063-007	20	Accessories: Gasket

For horizontal or vertical surface mounting

With 24V bulb.

Two fixing screws. Contacting via splice clamp connection.

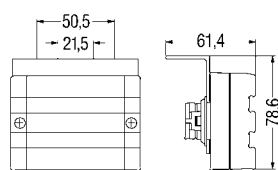
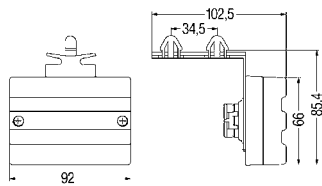
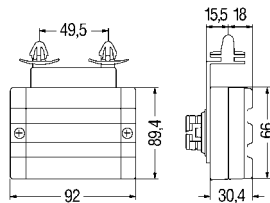
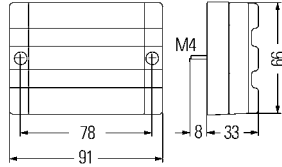

Part no.	Pk.	
2XS 340 000-101	1	Red lens.
8GM 002 092-241	10	Clearance light
		Spare parts:
		C5W bulb, 24V
		For front mounting.
		Clear lens.
2PF 340 000-111	1	Position light without reflector
2PG 340 000-121	1	Position light with reflector
		Spare parts:
8GM 002 092-241	10	C5W bulb, 24V
		Lens with reflector, amber.
2PS 340 000-001	1	Side-marker light with reflector
2PS 340 000-171	1	Side-marker light with reflector and 35 mm mounting bracket
		Spare parts:
8GM 002 092-241	10	C5W bulb, 24V
		Side-marker light with reflector and transverse clip angle, front, for horizontal mounting
2PS 340 000-011	1	
8GM 002 092-241	10	Spare parts:
		C5W bulb, 24V
		Side-marker light with reflector and longitudinal clip angle, rear, for horizontal mounting
2PS 340 000-021	1	
		Side-marker light with reflector and PC lens, with longitudinal clip angle, rear, for horizontal mounting
2PS 340 000-051	1	
8GM 002 092-241	10	Spare parts:
		C5W bulb, 24V
		Side-marker light with reflector, holder mounting surface points towards the back
2PS 340 000-041	1	
8GM 002 092-241	10	Spare parts:
		C5W bulb, 24V

For horizontal or vertical surface mounting

When attached horizontally, the optical field must point toward the outside of the vehicle.
 Can also be used as clearance light with reflector.
 In LED-technology.

Lens with reflector, red

Consumption: 0.05A at 12V/24V (3 LEDs).

Consumption: 0.04A at 12V/24V (1 LED).

Black body. Two holes for B4.2 fixing screws.

See LED instruction 2.

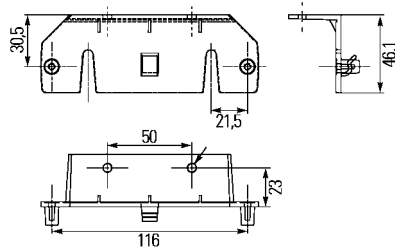
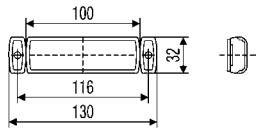

Part no.	Pk.	
		Rear light with reflector with 3 LEDs and 500 mm lead, 12V0.6W
2TM 008 645-081	1	
2TM 008 645-087	50	
2TM 008 645-091	1	and 5000 mm lead, 12V0.6W
2TM 008 645-061	1	and 500 mm lead, 24V1.2W
2TM 008 645-067	50	
2TM 008 645-071	1	and 5000 mm lead, 24V1.2W
2TM 008 645-077	50	
<hr/>		
		Rear light with reflector with 1 LED and 500 mm lead, 12V0.6W
2TM 008 645-931	1	
2TM 008 645-937	50	
2TM 008 645-951	1	und 500 mm lead 24V1.2W
2TM 008 645-957	50	
2TM 008 645-921	1	and 5000 mm lead, 12V0.6W
2TM 008 645-941	1	and 5000 mm, 24V1.2W
2TM 008 645-947	50	
2TM 008 645-651	1	and 300 mm lead and quick-contact incl. clamping piece for contacting a two-core flat lead, 24V1.2W
2TM 008 645-661	1	and 5000 mm lead and quick-contact incl. clamping piece for contacting a two-core flat lead, 24V1.2W
Accessories:		
9GD 157 876-007	55	Gasket
8PE 008 932-001	1	Mounting pliers for quick-link cable attachment
8HG 340 489-001	1	Holder, angled back
8HG 340 413-001	1	Clip angle, rear
8KW 998 602-002	1	Mounting plears for quick-link lead attachment
8HG 160 409-002	10	Holder with two fixing screws

For horizontal or vertical surface mounting

When attached horizontally, the optical field must point toward the outside of the vehicle.

In LED-technology.

Clear lens with reflector.

Consumption: 0.05A at 12V/24V (3 LEDs).

Consumption: 0.04A at 12V/24V (1 LED).

Black body (-167/-917 white). Two holes for B4.2 fixing screws.

See LED instruction 2.

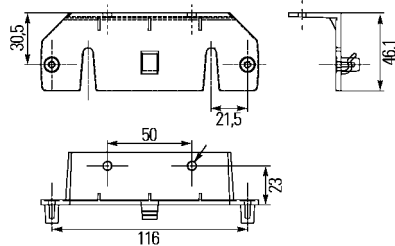
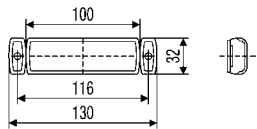

Part no.	Pk.	
2PG 008 645-167	40	Position light with reflector, with 3 LEDs, white body and 5000 mm lead, 24V1.2W
2PG 008 645-561	1	Position light with reflector, with 1 LED and 500 mm lead, 12V0.6W
2PG 008 645-567	50	
2PG 008 645-971	1	and 500 mm lead, 24V1.2W
2PG 008 645-977	50	
2PG 008 645-961	1	and 5000 mm lead, 24V1.2W
2PG 008 645-967	50	
2PG 008 645-631	1	and 300 mm lead and quick-contact incl. clamping piece for contacting a two-core flat lead, 24V1.2W
2PG 008 645-641	1	and 5000 mm lead and quick-contact incl. clamping piece for contacting a two-core flat lead, 24V1.2W
2PG 008 645-917	50	Position light with reflector, with 1 LED, white body and 5000 mm lead, 24V1.2W
Accessories:		
9GD 157 876-007	55	Gasket
8PE 008 932-001	1	Mounting pliers for quick-link cable attachment
8HG 340 489-001	1	Holder, angled back
8HG 340 413-001	1	Clip angle, rear
8KW 998 602-002	1	Mounting pliers for quick-link lead attachment
8HG 160 409-002	10	Holder with two fixing screws

For horizontal or vertical surface mounting

When attached horizontally, the optical field must point toward the outside of the vehicle.

In LED-technology.

Amber lens with reflector.

Consumption: 0.04A at 12V/24V (1 LED).

Consumption: 0.05A at 12V/24V (3 LEDs).

Black body. Two holes for B4.2 fixing screws.

See LED instruction 2.

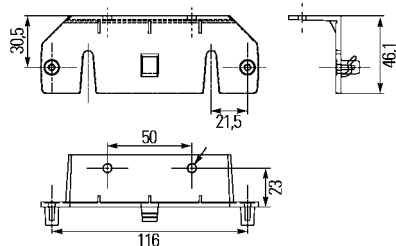
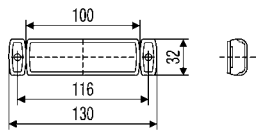

Part no.	Pk.	
2PS 008 645-011	1	Side-marker light with reflector for horizontal flush/surface mounting, with 1 LED and 1500 mm lead, 12V0.6W
2PS 008 645-001	1	with 1500 mm lead, 24V1.2W
2PS 008 645-007	50	
2PS 008 645-187	50	and 5000 mm lead, 24V1.2W
2PS 008 645-497	50	and 10000 mm lead, 24V1.2W
2PS 008 645-601	1	and 150 mm lead and quick-contact incl. clamping piece for contacting a two-core flat lead, 24V1.2W
2PS 008 645-607	50	
2PS 008 645-611	1	and 300 mm lead and quick-contact incl. clamping piece for contacting a two-core flat lead, 24V1.2W
2PS 008 645-617	50	
2PS 008 645-621	1	and 1300 mm lead and quick-contact incl. clamping piece for contacting a two-core flat lead, 24V1.2W
2PS 008 645-627	50	
<hr/>		
2PS 008 645-981	1	Side-marker light with reflector for vertical surface mounting, with 1 LED and 1500 mm lead, 12V0.6W
2PS 008 645-991	1	with 1500 mm lead, 24V1.2W
<hr/>		
2PS 008 645-021	1	Side-marker light with reflector for vertical surface mounting, with 3 LEDs with 1500 mm lead, 24V1.2W
2PS 008 645-257	50	and 180 mm lead with 2-pole AMP Superseal plug connector, 24V1.2W
Accessories:		
9GD 157 876-007	1	Gasket
8PE 008 932-001	1	Mounting pliers for quick-link cable attachment
8HG 340 489-001	1	Holder, angled back
8HG 340 413-001	10	Clip angle, rear
8KW 998 602-002	1	Mounting pliers for quick-link lead attachment
8HG 160 409-002	10	Holder with two fixing screws

For horizontal or vertical surface mounting

OneLED

In LED-technology. With 1 LED.

With 6.3 mm blade terminals.

Consumption: 0.04A at 12V and 24V.

See LED instruction 2.

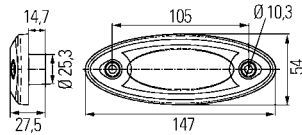

Part no.	Pk.	
		For horizontal surface mounting Red lens with reflector. Red body.
2TM 343 690-157	96	Rear light with reflector, 12V0.5W
2TM 343 690-351	1	Rear light with reflector, with 500 mm lead, 12V0.5W
2TM 343 690-357	96	
		For vertical surface mounting Red lens with reflector. Red body.
2TM 343 690-167	96	Rear light with reflector, 12V0.5W
2TM 343 690-367	96	Rear light with reflector, with 500 mm lead, 12V0.5W
		For horizontal surface mounting Clear lens with reflector. White body.
2PG 343 690-107	96	Position light with reflector, 12V0.5W
2PG 343 690-301	1	Position light with reflector, with 500 mm lead, 12V0.5W
2PG 343 690-307	96	
		For vertical surface mounting Clear lens with reflector. White body.
2PG 343 690-117	96	Position light with reflector, 12V0.5W
2PG 343 690-317	96	Position light with reflector, with 500 mm lead, 12V0.5W
		Accessories:
9GD 343 697-007	50	Gasket, black
9GD 343 697-107	50	grey

For horizontal or vertical surface mounting

OneLED

In LED-technology. With 1 LED.

With 6.3 mm blade terminals or 2-pole AMP plug.

Consumption: 0.04A at 12V and 24V.

See LED instruction 2.

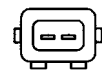
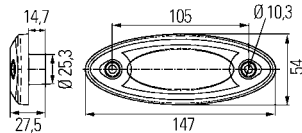

Part no.	Pk.	
		For horizontal or vertical surface mounting. Orange lens with reflector. White body.
2PS 343 690-001	1	Side-marker light with reflector, 12V0.5W
2PS 343 690-007	96	
2PS 343 690-201	1	Side-marker light with reflector, with 500 mm lead, 12V0.5W
2PS 343 690-207	96	
2PS 343 690-011	1	Side-marker light with reflector, 24V1.0W
2PS 343 690-017	96	
2PS 343 690-607	84	Side-marker light with reflector, with 2-pole AMP plug, 12V0,5W
2PS 343 690-407	96	Side-marker light with reflector, with 2-pole AMP plug, 24V1.0W
		For horizontal or vertical surface mounting. Orange lens with reflector. Grey body.
2PS 343 690-027	96	Side-marker light with reflector, 12V0.5W
2PS 343 690-031	1	Side-marker light with reflector, 24V1.0W
2PS 343 690-037	96	
		For horizontal or vertical surface mounting. Orange lens with reflector. Orange body.
2PS 343 690-047	96	Side-marker light with reflector, 12V0.5W
2PS 343 690-227	96	Side-marker light with reflector, with 500 mm lead, 12V0.5W
2PS 343 690-057	96	Side-marker light with reflector, 24V1.0W
2PS 343 690-427	96	Side-marker light with reflector, with 2-pole AMP plug, 24V1.0W
		For horizontal or vertical surface mounting. Orange lens with reflector. Black body.
2PS 343 690-061	1	Side-marker light with reflector, 12V0.5W
2PS 343 690-067	96	
2PS 343 690-411	1	Side-marker light with reflector, with 2-pole AMP plug, 24V1.0W
2PS 343 690-417	96	
2PS 343 690-617	84	Side-marker light with reflector, with 2-pole AMP plug, 12V0,5W
2PS 343 690-627	84	Side-marker light with reflector, with 2-pole AMP plug, 24V1.0W
2PS 343 690-237	96	Side-marker light with reflector, with 500 mm lead, 24V1,0W
		Accessories:
9GD 343 697-007	50	Gasket, black
9GD 343 697-107	50	grey

Bulb versions for horizontal flush mounting. LED versions for horizontal surface mounting

Two holes for M3.5 fixing screws.
See LED instruction 2.

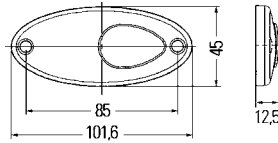

Part no.	Pk.	
		In LED-technology. With 2 LEDs. Red lens with reflector. With gasket and 5000 mm lead. Consumption: 0.04A at 12V/24V.
2TM 964 295-101	1	Rear light with reflector, 12V0.5W
2TM 964 295-107	20	
2TM 964 295-091	1	Rear light with reflector, 24V1.0W
2TM 964 295-097	20	

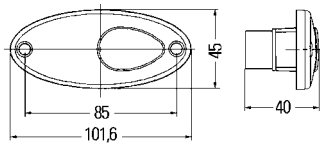

		Red lens with reflector. With gasket and 12V bulb.
2XS 964 295-031	1	Clearance light
2XS 964 295-037	50	
8GP 003 594-121	10	W5W bulb, 12V
9GT 343 367-002	30	Grommet



		For side mounting. Amber lens. With gasket and 12V bulb.
2BM 964 295-041	1	Auxiliary indicator
2BM 964 295-047	50	
8GP 003 594-121	10	W5W bulb, 12V
9GT 343 367-002	30	Grommet



		Amber lens with reflector. With gasket and 12V bulb.
2PS 964 295-001	1	Side-marker light with reflector
2PS 964 295-007	50	
8GP 003 594-121	10	W5W bulb, 12V
9GT 343 367-002	30	Grommet

		In LED-technology. With 2 LEDs. Amber lens with reflector. With two 500 mm leads, gasket and screw fixing. Consumption: 0.04A at 12V/24V.
2PS 964 295-061	1	Side-marker light with reflector, 12V0.5W
2PS 964 295-067	80	
2PS 964 295-051	1	Side-marker light with reflector, 24V1.0W
2PS 964 295-057	80	
2PS 964 295-347	80	Side-marker light with reflector, with 2-pole SuperSeal plug, 24V1.0W
2PS 964 295-357	80	Side-marker light with reflector, with 2-pole AMP-SuperSeal plug, 24V1.0W

		In LED-technology. With 2 LEDs. Amber lens with reflector. self-adhesive, with two 500 mm leads and covers for fixing holes. Consumption: 0.04A at 12V/24V.
2PS 964 295-081	1	Side-marker light with reflector, 12V0.5W
2PS 964 295-071	1	Side-marker light with reflector, 24V1.0W
2PS 964 295-077	80	

Bulb versions for horizontal flush mounting. LED versions for horizontal surface mounting

Two holes for M3.5 fixing screws.
See LED instruction 2.

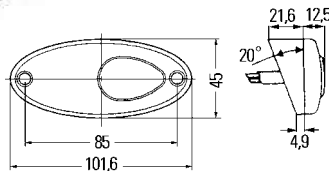
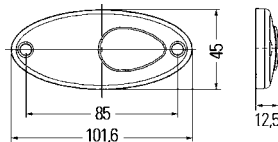
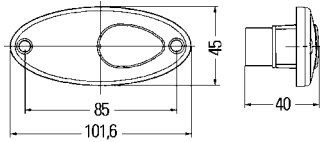

Part no.	Pk.	
		For front mounting. Clear lens. With gasket and 12V bulb.
2PG 964 295-011	1	Position light with reflector
2PG 964 295-017	50	Position light with reflector
		Spare parts/Accessories:
8GP 003 594-121	10	W5W bulb, 12V
9GT 343 367-002	30	Grommet
		For front mounting. In LED-technology. With 2 LEDs and gasket. Clear lens with reflector. Consumption: 0.03A at 12V/24V.
2PG 964 295-121	1	Position light with reflector, with 5000 mm lead, 12V0.3W
2PG 964 295-127	30	
2PG 964 295-337	80	Position light with reflector, with 800 mm lead, 12V0.3W
2PG 964 295-111	1	Position light with reflector, with 5000 mm lead, 24V0.6W
2PG 964 295-117	20	
		For front mounting. Clear lens with reflector. With gasket and 12V bulb.
2PF 964 295-021	1	Position light
2PF 964 295-027	50	
		Spare parts/Accessories:
8GP 003 594-121	10	W5W bulb, 12V
9GT 343 367-002	30	Grommet
		For front mounting. In LED-technology. Clear lens without reflector. With 2 LEDs and loose angular bracket (RAL 9010) for mounting to surfaces with an inclination of 20°. With 100 mm PVC lead and 2.8 mm blade terminal contacts with insulating sleeve. Consumption: 0.03A at 12V.
2PF 964 295-257	20	Position light, 12V0.3W

Reflector for horizontal or vertical surface mounting

For lights in model range 964 295-...
Self-adhesive.

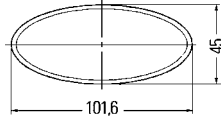

Part no.	Pk.	Reflector,
8RA 343 160-002	20	red
8RA 343 160-007	150	
8RA 343 160-012	20	white
8RA 343 160-017	150	
8RA 343 160-022	20	amber
8RA 343 160-027	150	

For horizontal or vertical flush mounting

In LED-technology. Clear lens.

Consumption: 0.04A at 12V, 0.02A at 24V.

With gasket covers for fixing holes.

See LED instruction 2.

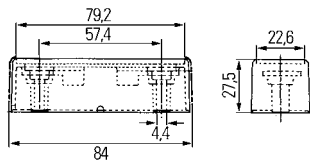
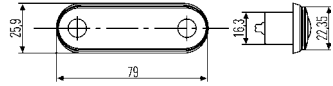

Part no.	Pk.	
		Red light. With 2 red LEDs 0.5W. Voltage range: 8V - 28V. For optional use as rear light or clearance light.
2XA 959 790-401	2	Signal light with 500 mm lead
2XA 959 790-407	30	
2XA 959 790-411	2	Signal light with 5000 mm lead
<hr/>		
White light. With 2 white LEDs 0.5W. Voltage range: 10V - 33V.		
2PF 959 590-401	1	Position light with 500 mm lead
2PF 959 590-407	30	
2PF 959 590-411	1	Position light with 5000 mm lead
2PF 959 590-417	30	
2PF 959 590-437	48	Position light with 8000 mm lead
2PF 959 590-457	30	Position light with 200 mm lead, 2-pole AMP plug and two 6.3 mm blade terminal contacts
<hr/>		
White light. With 1 white LEDs 0.5W. Voltage range: 10V - 33V.		
2PF 959 590-202	2	Position light with 500 mm lead
2PF 959 590-207	30	
2PF 959 590-212	2	Position light with 5000 mm lead
2PF 959 590-217	10	
2PF 959 590-218	105	
2PF 959 590-237	8	Position light with 8000 mm lead
2PF 959 590-257	30	Position light with 100 mm lead, 2-pole AMP plug and two 6.3 mm blade terminal contacts
9XD 160 867-007	16	Accessories: Bracket (adapter) for mounting the lights

For flush/surface mounting

In LED-technology. Clear lens.

Consumption: 0.04A at 12V, 0.02A at 24V.
See LED instruction 2.

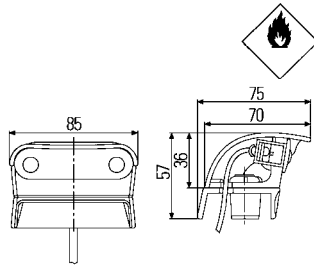
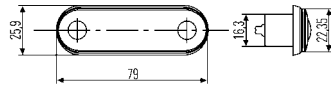

Part no.	Pk.	
		White light. With 2 white LEDs 0.5W. Black plastic body. With 2500 mm lead, cover, fixing screws and caps for screws. Voltage range: 10V - 33V.
2KA 959 640-102	3	Licence plate light for flush mounting above 520 x 120 mm licence plates (3 lights)
2KA 959 640-607	8	Licence plate light with spacer for surface mounting to the left and right of 520 x 120 mm licence plates

For horizontal surface mounting

Clear lens.

For surface mounting above 340 x 240 mm (1 light) and 520 x 120 mm (1 or 2 lights) licence plates or mounting to left and right of 340 x 240 mm and 520 x 120 mm licence plates. Two 4.5 mm dia. holes for fixing screws.

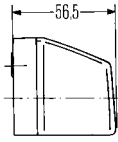
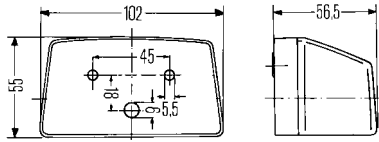

Part no.	Pk.	
Grey plastic body and black plastic base plate.		
2KA 003 389-011	1	Licence plate light
<hr/>		
2KA 003 389-001	1	Licence plate light
9BG 120 581-001	2	Spare parts/Accessories: Body with lens and screws R10W bulb,
8GA 002 071-131	10	12V
8GA 002 071-251	10	24V
8GA 002 071-271	10	24V (HD)
<hr/>		
Body and base plate of black plastic.		
2KA 003 389-061	1	Licence plate light
2KA 003 389-068	56	Licence plate light
2KA 003 389-062	1	Pro-fit pack
2KA 003 389-398	56	Licence plate light with 12V bulb
2KA 003 389-081	1	Licence plate light with 26 mm dia. opening in base plate for cable retention
9BG 121 587-031	2	Spare parts/Accessories: Body with lens and screws
9BG 121 587-037	60	
8GA 002 071-131	10	R10W bulb,
8GA 002 071-251	10	12V
8GA 002 071-271	10	24V
8GA 002 071-271	10	24V (HD)
<hr/>		
With black rubber base plate and vibration damping.		
2KA 003 389-211	2	Licence plate light
2KA 003 389-217	48	
9BG 121 587-071	2	Spare parts/Accessories: Body with lens and screws
8GA 002 071-131	10	R10W bulb,
8GA 002 071-251	10	12V
8GA 002 071-251	10	24V

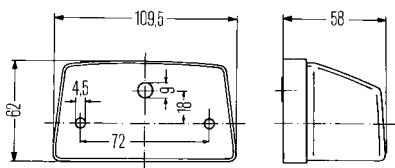
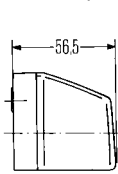
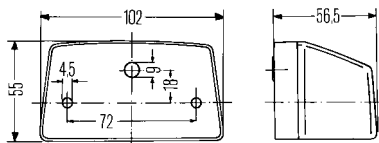

For horizontal surface mounting

Body and base plate of black plastic.
Two 4.5 mm dia. holes for fixing screws.

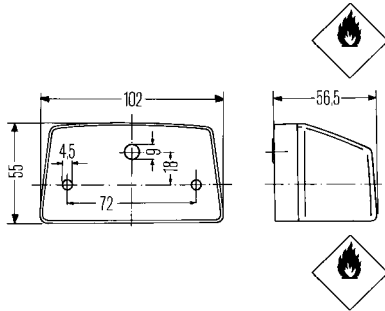

Part no.	Pk.	
2PF 003 389-037	1	Clearance light with clear lens
		Accessories:
8GA 002 071-131	10	R10W bulb, 12V
8GA 002 071-251	10	24V
2PF 003 389-041	1	Clearance light with red lens
		Accessories:
8GA 002 071-121	10	R5W bulb, 12V
8GA 002 071-241	10	24V

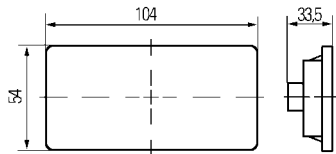

For horizontal flush mounting

In LED-technology. With 4 LEDs and 500 mm lead.
 Amber lens with reflector.
 Consumption: 0.04A at 24V.
 See LED instruction 2.

Part no.	Pk.	
2PS 007 972-011	4	Side-marker light with reflector, 24V1.0W
2PS 007 972-017	100	

For flush mounting installation in front or rear plastic bumpers

For retrofitting of passenger cars.
 Clear lens.

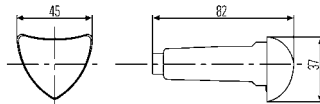

Part no.	Pk.	
2PS 008 541-801	1	Set comprises: 4 side-marker lights with clear lens, 4 amber bulbs 12V5W, leads and installation material.
8GP 003 594-541	10	Spare parts: WY5W bulb, 12V

For horizontal surface mounting

In LED-technology. With 3 LEDs.
 Amber lens with reflector.
 Consumption: 0.06A at 12V/24V.
 Grey base plate. With 500 mm lead with stripped cable ends.
 Two 4.5 mm dia. holes for fixing screws.
 See LED instruction 2.

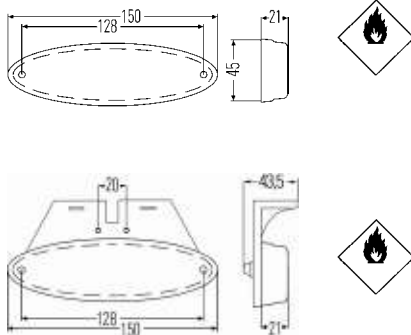

Part no.	Pk.	
2PS 007 943-311	8	Without bracket. Side-marker light with reflector, 12V0.7W
2PS 007 943-317	105	
2PS 007 943-011	8	Side-marker light with reflector, 24V1.4W
2PS 007 943-017	105	
2PS 007 943-321	10	With bracket, angled forwards. Side-marker light with reflector, 12V0.7W
2PS 007 943-021	10	
2PS 007 943-027	124	

For horizontal surface mounting

In LED-technology. With 2 LEDs.
Amber lens with reflector.
 Consumption: 0.06A at 12V/24V.
 Black body. Self-adhesive.
 See LED instruction 2.

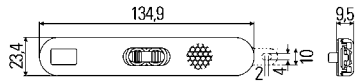

Part no.	Pk.	
2PS 009 226-021	1	Side-marker light with reflector with 195 mm lead, 12V0.5W
2PS 009 226-027	300	
2PS 009 226-067	300	without lead, with 6.3 mm blade terminals, 12V0.5W
2PS 009 226-017	300	with 195 mm lead and AMP plug connector, 24V1.0W
2PS 009 226-037	1	with 195 mm lead, without AMP plug connector, 24V1.0W

For flush mounting in front or rear plastic bumpers

For retrofitting passengers cars < 6 m.
In LED-technology. Amber light.
Set comprises: 4 side-marker lights, each with 3 LEDs and installation material.
 Consumption: 0.06A at 12V.
 See LED instruction 2.

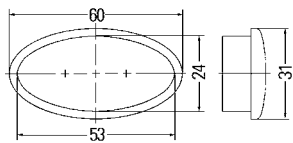

Part no.	Pk.	
2PS 008 138-801	1	Side-marker light set, 12V0.7W, with amber lens and silver grey shields
2PS 008 138-811	1	with light grey lens and black shields
2PS 008 138-821	1	with light grey lens and silver grey shields
		Spare parts:
2PS 008 138-001	1	Side-marker light for -801
2PS 008 138-101	1	for -811
2PS 008 138-111	1	for -821

For horizontal flush or surface mounting

In LED-technology. With 4 LEDs. Amber lens.

Consumption: 0.04A at 24V.

See LED instruction 2.

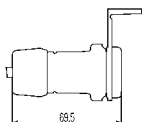
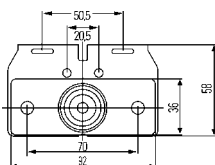
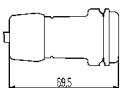
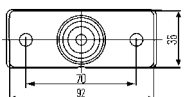
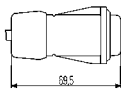
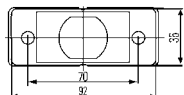

Part no.	Pk.	
2PS 008 382-001 2PS 008 382-007	1 60	Side-marker light in combination with reflector 9EL 154 637-001. Side-marker light for flush mounting, 24V1.0W
2PS 008 382-801 2PS 008 382-807	1 60	Set comprises: Side-marker lights without reflector, with separate reflector. Side-marker light set for flush mounting, 24V1.0W
2PS 008 382-811 2PS 008 382-817	1 72	Set comprises: Side-marker light without reflector, with separate reflector. Side-marker light set with bracket, angled forwards, for surface mounting, 24V1.0W
2PS 008 382-001 9EL 154 637-001	1 1	Spare parts: Side-marker light with reflector Reflector

For horizontal flush mounting

Black rubber body.
Two holes for B4.2 x 19 fixing screws.

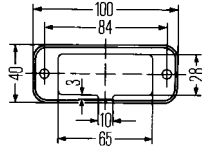
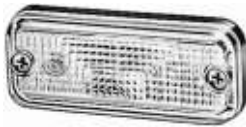

Part no.	Pk.	
		Red lens.
2SA 961 167-011	2	Rear light for installation positions 0° - 4°
		Clear lens.
2PF 961 167-021	2	Position light for installation positions 60° - 67°
9EL 137 241-001	4	Spare parts/Accessories: Clear lens with contact springs
8GM 002 092-121	10	C5W bulb, 12V
8GM 002 092-241	10	24V

In LED-technology. With 2 Power LEDs 0.5W. Clear lens.

Consumption: 0.02A at 24V. Black rubber body.
2 holes in the lens for attachment of the light using 2 PT screws 5 x 25 Torx and 2 washers Ø 4.2 mm (not part of the scope of supply).
Tightening torque max. 2 Nm. See LED instruction 2.

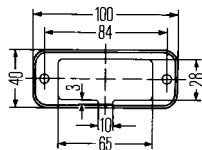

Part no.	Pk.	
2PF 009 514-001	1	Position light for installation positions 10° - 20°
2PF 009 514-011	1	for installation positions 20° - 30°

For flush mounting

Two holes for B4.2 x 16 fixing screws.

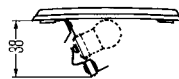
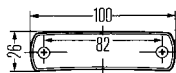

Part no.	Pk.	
		Red lens. National type test for Germany.
2SA 001 647-041	1	Rear light
		Clear lens.
2PF 001 647-031	4	Position light
2PF 001 647-037	80	
		Accessories: R10W bulb,
8GA 002 071-121	10	12V
8GA 002 071-241	10	24V

For horizontal surface mounting

For roof mounting.

Grey plastic body. With rubber base.
Roof inclination (0° - 90°) can be compensated.
Two 5.3 mm dia. holes for fixing screw.

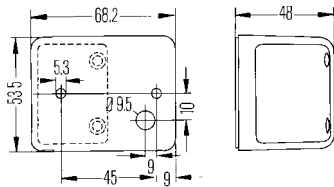

Part no.	Pk.	
		Red lens.
2SA 006 679-027	1	Rear light
		Clear lens.
2PF 006 679-007	20	Position light
		Accessories:
8GA 002 071-131	10	R10W bulb, 12V
8GA 002 071-251	10	24V

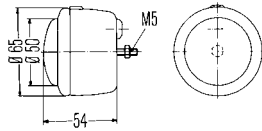

Black body. Central M5 fixing screw.

Part no.	Pk.	
		Red lens.
2SA 001 634-121	2	Rear light
		Clear lens.
2PF 001 634-101	2	Position light
		Spare parts/Accessories:
9EL 132 404-001	2	Lens with screw for -121
9EL 132 403-001	2	for -101
		C5W bulb,
8GM 002 092-121	10	12V
8GM 002 092-241	10	24V

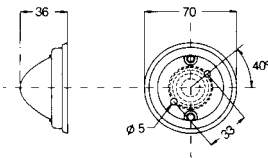

Steel base plate with soft plastic backing.
Two holes for M4 fixing screws. Screw-contact.

Part no.	Pk.	
		Red lens.
2SA 997 022-001	1	Rear light with chrome-plated rim
2SA 997 023-001	1	Rear light without chrome-plated rim
		Clear lens.
2PF 997 022-011	1	Position light with chrome-plated rim
2PF 997 023-011	1	Position light without chrome-plated rim
		Accessories:
		C5W bulb,
8GM 002 092-121	10	12V
8GM 002 092-241	10	24V

For surface mounting

In LED-technology.

Consumption
 with 2 LEDs: 0.04A at 12V, 0.02A at 24V,
 with 1 LED: 0.07A at 12V, 0.04A at 24V,
 See LED instruction 2.



2XA 959 560-401
 2XA 959 560-407

2
 16

Red light, clear lens.
Inner lens red.
 Voltage range: 8V - 28V.

Clearance light
with 2 LEDs 0.5W,
black body and 500 mm lead

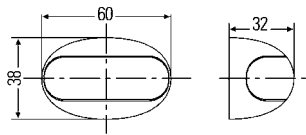

2XA 959 560-411
 2XA 959 560-417

2
 10

Clearance light
with 2 LEDs 0.5W,
black body and 5000 mm lead



2PF 959 570-401
 2PF 959 570-407

2
 16

White light, clear lens.
 Voltage range: 10V - 33V.

Position light
with 2 LEDs 0.5W,
black body and 500 mm lead



2PF 959 570-411
 2PF 959 570-417

2
 10

Position light
with 2 LEDs 0.5W,
black body and 5000 mm lead



2PF 959 570-202
 2PF 959 570-207

2
 16

Position light
with 1 LED 0.8W,
black body and 500 mm lead



2PF 959 570-212
 2PF 959 570-217

2
 10

Position light
with 1 LED 0.8W,
black body and 5000 mm lead



2PF 959 570-427

16

Position light
with 2 LEDs 0.5W,
white body and 500 mm lead

8HG 959 571-007

80

Accessories:
 White bracket, for -427
 for mounting on surfaces with 25° inclination

For horizontal surface mounting

Chrome-plated body.
Two B4.8 x 19 fixing screws.

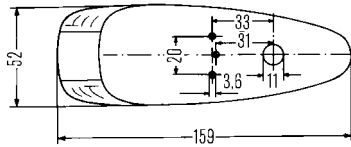

Part no.	Pk.	
2SA 001 638-021	2	Red lens.
		Rear light
		Spare parts/Accessories:
9EL 107 443-061	2	Lens with screw
9GD 082 716-001	10	Rubber base for flat surfaces
9GD 100 140-001	10	for curved surfaces
8GP 003 594-121	10	W5W bulb, 12V
8GP 003 594-241	10	24V
		Clear lens.
2PF 001 638-011	2	Position light
		Spare parts/Accessories:
		Rubber base
9GD 082 716-001	10	for flat surfaces
9GD 100 140-001	10	for curved surfaces
8GA 002 071-121	10	R5W bulb, 12V
8GA 002 071-241	10	24V

For horizontal or vertical surface mounting

Red rear light, white position light.
With M10 x 1 fixing screw.

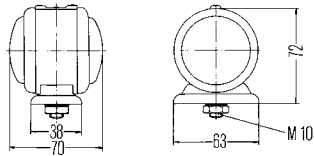

Part no.	Pk.	
2TJ 001 633-211	2	Rear-position light
		Spare parts/Accessories:
		Lens with screw,
9EL 132 403-001	2	white
9EL 132 404-001	2	red
		C5W bulb,
8GM 002 092-121	10	12V
8GM 002 092-241	10	24V

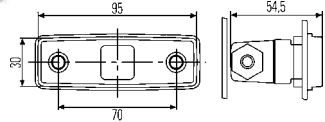

For flush mounting

Clear lens, with reflector.
With 24V bulb.

Contacting via 2.8 mm blade terminals.
Two 5 mm dia. holes for fixing screws.

Part no.	Pk.	
2PG 008 434-001	2	Position light with reflector
8GP 002 067-241	10	Spare parts: T4W bulb, 24V

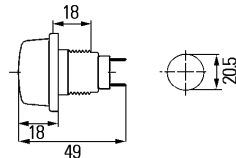
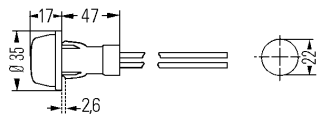

Clear lens.

Part no.	Pk.	
2PF 003 563-151	10	With 800 mm long earth lead and 1800 mm long positive lead Position light
2PF 003 563-177	100	Without lead. With plastic nut M20 x 1.5 and 6.3 mm blade terminal contact. The light is fastened by rear screwing of the plastic nut. Position light with 12V bulb
2PF 003 563-187	100	Position light with 24V bulb
8GP 003 594-121	10	Spare parts/Accessories: W5W bulb, 12V
8GP 003 594-241	10	24V

For flush mounting in trailer

With rubber body and preinstalled wiring harness.

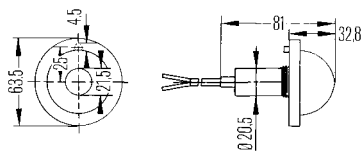

Part no.	Pk.	
2PF 007 205-007	10	Frosted white lens. Position light
2PF 007 205-001	1	Position light Pro-fit pack
2PF 007 205-017	1	With green lens. Trucks and trailers equipped with ABS which do not yet have plug connectors to ISO 3731 (24S), ISO 7638 or ISO 1185 (24N) are required to equip the trailer with a green position light mounted in the field of vision side for indicating the function of the ABS. Position light
8KA 950 073-001	10	Spare parts/Accessories: Lead with bulb holder for -007/-001
8GA 002 071-121	10	R5W bulb, 12V
8GA 002 071-241	10	24V

For horizontal surface mounting

Clear lens.

Two holes for B3.9 x 9.5 fixing screws.

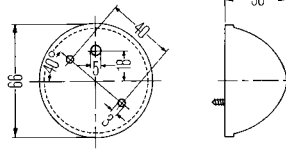

Part no.	Pk.	
2PF 001 650-001	2	Position light
9EL 084 110-001	5	Spare parts/Accessories: Lens
8GM 002 092-121	10	C5W bulb, 12V
8GM 002 092-241	10	24V

Clear lens.

Black plastic body.

M10 hollow fixing bolt and cable entry.

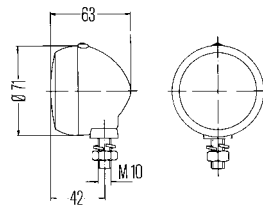

Part no.	Pk.	
2PF 001 648-161	4	Position light without chrome-plated rim
2PF 001 648-171	4	with chrome-plated rim
9EL 108 435-001	5	Spare parts/Accessories: Lens with screws for -161 R5W bulb,
8GA 002 071-121	10	12V
8GA 002 071-241	10	24V

For horizontal or vertical surface mounting

Clear lens. With 12V bulb.

Two M5 fixing screws.

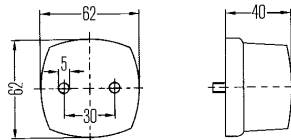

Part no.	Pk.	
2PF 996 112-031	1	Position light
8GM 002 092-121	10	Spare parts/Accessories: C5W bulb, 12V

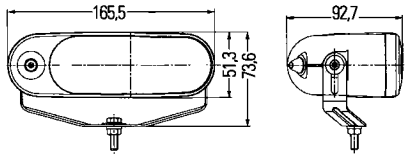

For horizontal surface mounting

Clear lens.

Black plastic body.
With one M6 x 20 fixing screw.
Contents: 2 lights incl. wiring harness, bulbs and universal bracket for mounting on front bumper.

Part no.	Pk.	
2PT 008 362-801	1	Daytime running light set, 12V
8GH 007 643-121	10	Spare parts: H6W bulb, 12V

For flush/surface mounting

Clear lens.

Body made of diecast aluminium.

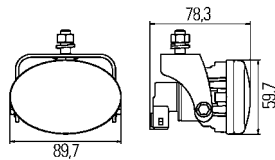

Part no.	Pk.	
2PT 010 047-821	1	Contents: 2 lights with wiring harness, 12V bulb and universal hoop bracket for mounting to the vehicle front. Daytime running light set, 12V

With universal hoop bracket for mounting to the vehicle front.

2PT 010 047-211	1	Daytime running light with 12V bulb
-----------------	---	--

Mounting by means of carrier frame in the front apron.

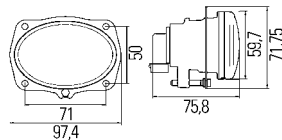

2PT 010 047-201	1	Daytime running light with 12V bulb
8GA 002 073-121	10	Spare parts: P21W bulb, 12V

Clear lens, without optical pattern.

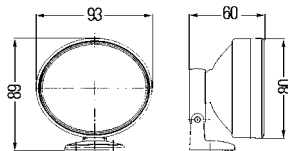

Part no.	Pk.	
2PT 008 935-801	1	Contents: 2 lights with 12V/16W bulbs, 2 brackets with connecting leads, accessories and installation material. Daytime running light set, 12V
2PT 008 935-811	1	Daytime running light set, 24V
2PT 008 935-001	1	Spare parts: Light unit contains: reflector with bulb, connecting lead with plug
4RA 933 791-061	1	Relay, 12V

For flush mounting. With bracket, lead with plug and 12V/16W bulb.

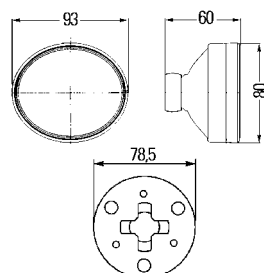

2PT 008 935-011	1	Daytime running light, 12V
2PT 008 935-017	30	

For flush mounting

In LED-technology. Clear lens.

Power consumption: daytime running light 12V/24V 5.8W,
position light 12V/24V 0.6W.

Consumption: daytime running light: 0.48A at 12V, 0.24A at 24V.

Consumption: position light: 0.05A at 12V, 0.025A at 24V.

Body made of diecast aluminium.

With 3-pole Superseal plug connector.



Part no.	Pk.	Contents:
		2 lighting systems with 5 individual lights inc. LEDs and 2 electronic control units.
2PT 010 458-801	1	Daytime running light set without position light
2PT 010 458-811	1	Daytime running light set with position light
		Spare parts/Accessories:
		Daytime running light set without position light
2PT 177 696-801	1	with position light
2PT 177 696-811	1	Electronic control module
5DS 010 668-001	5	for -801
5DS 010 668-011	5	for -811
8KB 178 139-001	1	500 mm lead with
8KB 178 139-002	25	2-pole Superseal plug connector
8KA 165 959-001	5	2700/1800 mm lead with
		3-pole Superseal plug connector
		Contents:
		2 lighting systems with 6 individual lights inc. LEDs and 2 electronic control units.
2PT 010 458-821	1	Daytime running light set without position light
2PT 010 458-831	1	Daytime running light set with position light
		Spare parts/Accessories:
		Daytime running light set without position light
2PT 177 696-821	1	with position light
2PT 177 696-831	1	Electronic control module
5DS 010 668-001	5	for -821
5DS 010 668-011	5	for -831
8KB 178 139-001	1	500 mm lead with
8KB 178 139-002	25	2-pole Superseal plug connector
8KA 165 959-001	5	2700/1800 mm lead with
		3-pole Superseal plug connector

For flush mounting

In LED-technology. Clear lens.

Power consumption: daytime running light 12V/24V 5.8W, position light 12V/24V 0.6W.

Consumption: daytime running light: 0.48A at 12V, 0.24A at 24V.

Consumption: position light: 0.05A at 12V, 0.025A at 24V.

Body made of diecast aluminium.

With 3-pole Superseal plug connector.



Part no.	Pk.	Contents:
		2 lighting systems with 7 individual lights inc. LEDs and 2 electronic control units.
2PT 010 458-841	1	Daytime running light set without position light
2PT 010 458-851	1	Daytime running light set with position light
		Spare parts/Accessories:
		Daytime running light set without position light
2PT 177 696-841	1	with position light
2PT 177 696-851	1	Electronic control module
5DS 010 668-001	5	for -841
5DS 010 668-011	5	for -851
8KB 178 139-001	1	500 mm lead with
8KB 178 139-002	25	2-pole Superseal plug connector
8KA 165 959-001	5	2700/1800 mm lead with
		3-pole Superseal plug connector
		Contents:
		2 lighting systems with 8 individual lights inc. LEDs and 2 electronic control units.
2PT 010 458-861	1	Daytime running light set without position light
2PT 010 458-871	1	Daytime running light set with position light
		Spare parts/Accessories:
		Daytime running light set without position light
2PT 177 696-861	1	with position light
2PT 177 696-871	1	Electronic control module
5DS 010 668-001	5	for -861
5DS 010 668-011	5	for -871
8KB 178 139-001	1	500 mm lead with
8KB 178 139-002	25	2-pole Superseal plug connector
8KA 165 959-001	5	2700/1800 mm lead with
		3-pole Superseal plug connector

For flush mounting

In LED-technology. With 3 LEDs. Clear lens.

Power consumption: 12V < 5 W, 24V < 11 W.

Consumption: 0.36A at 12V / 24V.

Black aluminium body.

With 500 mm connection lead with 3-pin waterproof plug.

Voltage range: 9V - 33V. See LED instruction 2.

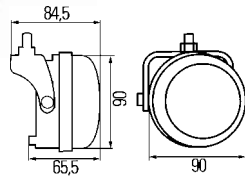
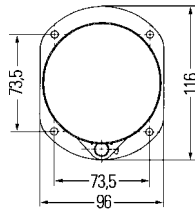
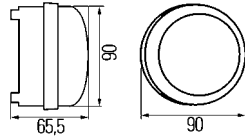

Part no.	Pk.	
		Attachment by means of carrier frame in front aprons (see accessories for carrier frames).
2PT 009 599-011	1	Daytime running light for flush mounting, left
2PT 009 599-021	1	Daytime running light for flush mounting, right
2PT 009 599-031	1	Daytime running light with position light for flush mounting, left
2PT 009 599-041	1	Daytime running light with position light for flush mounting, right
		Accessories:
9AH 165 968-001	1	Supporting frame
8HG 165 967-001	1	Bracket
8KA 165 959-001	5	2700/1800 mm lead with 3-pole Superseal plug connector
8JA 746 184-032	10	Superseal plug, 3-pole
8KW 744 837-002	50	Jack contact for cables 1.0 - 1.5 mm ² dia.
9GD 746 185-002	50	Strand insulation for cable outside 1.8 - 2.4 mm ² dia.
		Mounting by means of bracket on or in the front apron.
		Contents: 2 lights with 3 LEDs, pre-assembled lead set and mounting instructions
2PT 009 599-801	1	Daytime running light set for flush or surface mounting
		Accessories:
8KA 165 959-001	5	2700/1800 mm lead with 3-pole Superseal plug connector
8JA 746 184-032	10	Superseal plug, 3-pole
8KW 744 837-002	50	Jack contact for cables 1.0 - 1.5 mm ² dia.
9GD 746 185-002	50	Strand insulation for cable outside 1.8 - 2.4 mm ² dia.

For flush mounting

LEDayLine

In LED-technology. With 5 white LEDs 8.0W. Clear lens.

Consumption: 0.67A at 12V, 0.33A at 24V.

Black plastic body.

Mounting by means of carrier frame in the front apron

With Superseal connector.

See LED instruction 2.

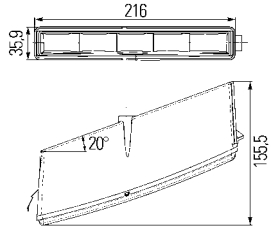

Part no.	Pk.	Contents:
		2 lights 2PT 010 043-011/-021 with wiring harness
2PT 010 043-801	1	Daytime running light set, 12V
2PT 010 043-011	1	Daytime running light, 12V, left
2PT 010 043-021	1	right
2PT 010 043-031	1	Daytime running light, 24V left
2PT 010 043-041	1	right
		Accessories:
		Cable set, 2700/1800 mm long, with Supersealed plug, 3-pole, for connection 2 daytime running lights
8KA 165 959-001	5	Superseal plug, 3-pole
8JA 746 184-032	10	Jack contact for cables 1.0 - 1.5 mm ² dia.
8KW 744 837-002	50	Strand insulation for cable outside 1.8 - 2.4 mm ² dia.
9GD 746 185-002	50	

In LED-technology. With 12 white LEDs 2.0W. Clear lens.

Consumption: 0.17A at 12V, 0.09A at 24V.

5 holes Ø 4.2 mm for fixing screws.

See LED instruction 2.

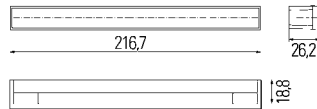

Part no.	Pk.	Contents:
		2 lights with 2500 mm lead and relay.
2PT 980 680-821	1	Daytime running light set, 12V
2PT 980 680-861	1	Daytime running light set, 24V
2PT 980 680-101	1	Daytime running light with 2500 mm lead, 12V
2PT 980 680-601	1	24V
		Spare parts/Accessories:
4RD 933 332-041	1	Relay, 12V

For surface mounting

In LED-technology. With 3 white LEDs. Clear lens.

Power consumption: 12V < 5.5W, 24V < 11.0W.

Consumption: 0.36A at 12V/24V.

Body made of silver-coloured aluminium.

Voltage range: 9V - 33V. See LED instruction 2.

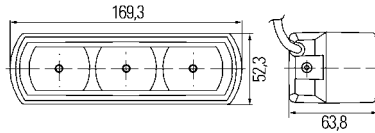

Part no.	Pk.	
2PT 009 496-801	1	Mounting by means of bracket on or in the front apron.
		Contents: 2 lights without position light, with three LEDs, 200 mm long wiring harness with Superseal plug connector and brackets.
2PT 009 496-007	42	Without bracket, with 500 mm long wiring harness and Superseal plug connector.
		Daytime running light set without position light
		Daytime running light with position light
		Accessories:
8KA 165 959-001	5	Cable set, 2700/1800 mm long, with Superseal plugs, 3-pole, for connection 2 daytime running lights
8JA 746 184-032	10	Superseal plug, 3-pole
8KW 744 837-002	50	Jack contact for cables 1.0 - 1.5 mm ² dia.
9GD 746 185-002	50	Strand insulation for cable outside 1.8 - 2.4 mm ² dia.

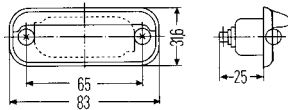

Clear lens.

For flush mounting above or below 520 x 120 mm (2 or 3 lights) and 340 x 240 mm (2 lights) licence plates. Depth required for flush fitting: 25 mm. With separate ground connection

Part no.	Pk.	
2KA 001 378-001	4	Licence plate light with chrome-plated rim and two M4 fixing screws
2KA 001 378-041	4	Licence plate light with silver-coloured finish, without fixing screws
2KA 001 378-127	1	Licence plate light with black edge and 12V bulb, without fixing screws
2KA 001 378-207	100	without fixing screws, with blade terminal contacts angled 45°
8GM 002 092-121	10	Spare parts/Accessories: C5W bulb, 12V
8GM 002 092-241	10	24V

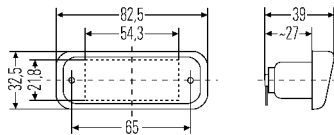

Clear lens.

For flush mounting above (2 lights) of 520 x 120 mm licence plates. Black plastic body. Depth required for flush fitting: 25 mm. With separate ground connection.

Part no.	Pk.	
2KA 005 049-008	18	Licence plate light with 12V bulb
2KA 005 049-011	2	with 24V bulb
2KA 005 049-017	42	
8GM 002 092-121	10	Spare parts: C5W bulb, 12V
8GM 002 092-241	10	24V



Clear lens. With 12V bulb.

For flush mounting above or below (1 light) 520 x 120 mm licence plates. Black plastic body. Two 4.5 mm dia. holes for fixing screws. For John Deere.

Part no.	Pk.	
2KA 003 738-057	1	Licence plate light
8GM 002 092-121	10	Spare parts: C5W bulb, 12V

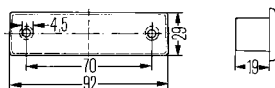

Clear lens. With 12V bulb.

For flush mounting above or below (2 lights) 520 x 120 mm licence plates. Depth required for flush fitting: 20 mm.

Part no.	Pk.	
2KA 004 331-061	5	Licence plate light with two holes for 4.5 mm dia. fixing screws
2KA 004 331-067	100	
2KA 004 331-107	100	with PC lens and two holes for B4.2 x 13 fixing screws
8GM 002 092-121	10	Spare parts: C5W bulb, 12V

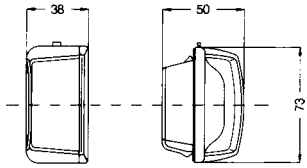

Clear lens.

For flush mounting. Plastic body with integrated bulb carrier.
Quick mount lens light fixed with snap mount.
With blade terminal contact.

Part no.	Pk.	
2KA 997 122-001	1	Licence plate light
Accessories:		
8GA 002 071-131	10	R10W bulb, 12V

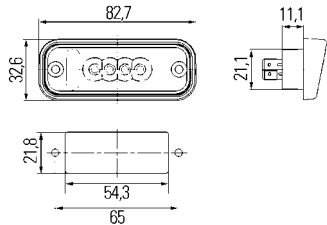

In LED-technology. With 4 LEDs 1.0W. Clear lens.

With black plastic rim.
Two holes for St3.9 fixing screws.
With blade terminal contact 6.3 x 0.8 mm.
Consumption: 0.08A at 12V, 0.04A at 24V.
See LED instruction 2.

Part no.	Pk.	
For flush mounting above or below (2 lights) 520 x 120 mm licence plates.		
2KA 010 278-311	1	Licence plate light, 12V
2KA 010 278-317	196	
2KA 010 278-011	1	Licence plate light, 24V
2KA 010 278-017	196	
For flush mounting above or below 340 x 240 mm (1 light) licence plates.		
2KA 010 278-411	1	Licence plate light, 12V
2KA 010 278-111	1	Licence plate light, 24V



In LED-technology. With 4 LEDs 1.0W. Clear lens.

Black plastic body.
Two M5 x 35 fixing screws.
With blade terminal contact 6.3 x 0.8 mm.
Consumption: 0.08A at 12V, 0.04A at 24V.
See LED instruction 2.

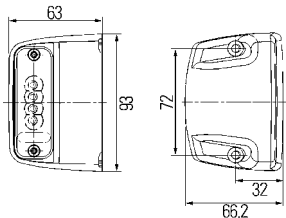

Part no.	Pk.	
For surface mounting to left or right of 520 x 120 mm licence plates (1 light).		
2KA 010 278-321	1	Licence plate light, 12V
2KA 010 278-327	84	
2KA 010 278-021	1	Licence plate light, 24V
2KA 010 278-027	84	
2KA 010 278-031	1	Licence plate light with two-core 2000 mm lead with blade receptacles 6.3 x 0.8mm, 24V
2KA 010 278-041	1	Licence plate light with two-core 2000 mm lead with Quick-Link lead attachment, 24V
2KA 010 278-051	1	Licence plate light with two-core 2000 mm lead with 2-pin EasyConn central plug, 24V
For surface mounting to left or right of 340 x 240 mm licence plates (1 light).		
2KA 010 278-421	1	Licence plate light, 12V
2KA 010 278-121	1	Licence plate light, 24V

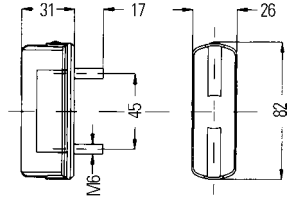

Clear lens.

For surface mounting. Two M6 fixing screws.

Part no.	Pk.	
2KA 997 011-011	1	Licence plate light with screw-contact and chrome-plated steel body
2KA 997 011-001	1	and black steel body
		Accessories:
8GM 002 092-121	10	C5W bulb, 12V
8GM 002 092-241	10	24V
2KA 997 011-021	1	Licence plate light with blade terminal contact and black plastic body
		Accessories:
8GM 002 092-121	10	C5W bulb, 12V
8GM 002 092-241	10	24V

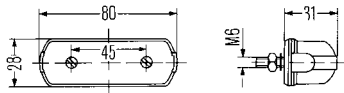

Clear lens. Black body.

For surface mounting above or below 520 x 120 mm (2 or 3 lights), 340 x 240 mm (2 lights) and 240 x 130 mm (1 light) licence plates, or mounting to left and right of 520 x 120 mm licence plates. Two M6 fixing screws.

Part no.	Pk.	
2KA 001 389-101	10	Licence plate light
		Spare parts/Accessories:
9BG 119 721-001	5	Body with lens
		C5W bulb,
8GM 002 092-121	10	12V
8GM 002 092-241	10	24V

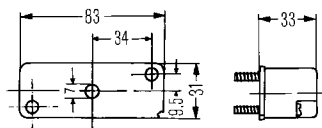

Clear lens. Black body.

Two B3,9 x 38 fixing screws.

Part no.	Pk.	
2KA 003 168-021	2	Licence plate light
		Accessories:
		C5W bulb,
8GM 002 092-121	10	12V
8GM 002 092-241	10	24V

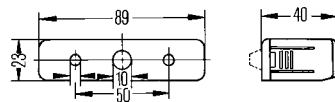

Clear lens. Black body.

For surface mounting above (2 lights) or mounting to left and right of 520 x 120 mm licence plates. Two 5.5 mm dia. holes for fixing screws.

Part no.	Pk.	
2KA 006 896-001	4	Licence plate light
2KA 006 896-007	102	
		Accessories:
		C5W bulb,
8GM 002 092-121	10	12V
8GM 002 092-241	10	24V

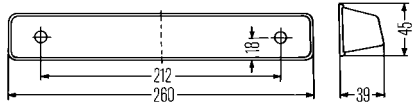

Clear lens. Silver coloured body.

For surface mounting above 520 x 120 mm or 340 x 240 mm licence plates. Two 4.5 mm dia. holes for fixing screws.

Part no.	Pk.	
2KA 001 610-001	1	Licence plate light
8GM 002 092-121	10	Accessories: C5W bulb, 12V

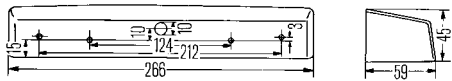

Clear lens. Black body.

For surface mounting above 520 x 120 mm or 340 x 240 mm licence plates. Four holes for B4.2 x 16 fixing screws.

Part no.	Pk.	
2KA 004 525-001	1	Licence plate light
8GM 002 092-121	10	Accessories: C5W bulb, 12V
8GM 002 092-241	10	24V

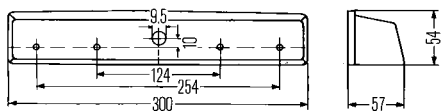

Clear lens. Silver coloured body.

For surface mounting above 520 x 120 mm or 340 x 240 mm licence plates. Four 5.5 mm dia. holes for fixing screws.

Part no.	Pk.	
2KA 001 622-001	2	Licence plate light
9EL 108 651-001	2	Spare parts/Accessories: Lens
8GM 002 092-121	10	C5W bulb, 12V

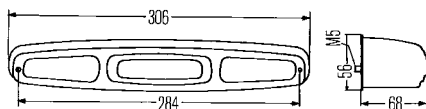

Clear lens. Black body.

Two M5 fixing screws.

Part no.	Pk.	
2KA 003 010-007	1	Licence plate light
8GA 002 071-121	10	Spare parts: R5W bulb, 12V
8GA 002 071-241	10	24V

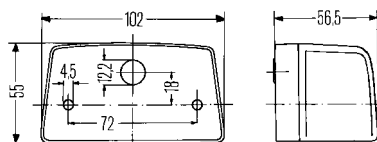

Black plastic body and base plate.

For surface mounting above or below 520 x 120 mm (1 or 2 lights) and 340 x 240 mm (1 light) license plates, or mounting to left and right of 520 x 120 mm and 340 x 240 mm licence plates.

Bulb holder with vibration damping. Two holes for M5 fixing screws.

Part no.	Pk.	
2KA 998 523-001	1	Licence plate light for mounting above licence plates
2KA 998 523-007	160	
2KA 998 523-117	90	with 12V bulb and lead, for mounting below licence plates
8GA 002 071-131	10	Spare parts/Accessories: R10W bulb, 12V
8GA 002 071-251	10	24V



Rear-Logic

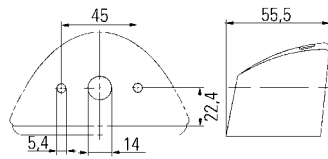

Clear lens. Black plastic body. With grommet.

For surface mounting above 340 x 240 mm and 520 x 120 mm (2 lights) licence plates or mounting to left and right of 340 x 240 mm and 520 x 120 mm licence plates.
Two 5.4 mm dia. holes for fixing screws.

Part no.	Pk.	
2KA 007 929-001	2	Licence plate light
2KA 007 929-007	72	
Accessories:		
8GM 002 092-121	10	C5W bulb, 12V
8GM 002 092-241	10	24V

Clear lens.

For surface mounting to left and right of 520 x 120 mm and 340 x 240 mm licence plates.
With blade terminal contacts and grommet.

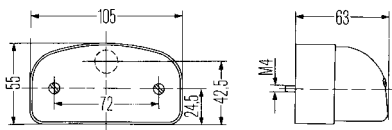
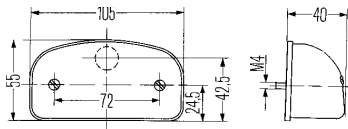

Part no.	Pk.	
2KA 001 386-231	2	Licence plate light with two 4.5 mm dia. holes for fixing screws and black body
2KA 001 386-241	2	with two 4.5 mm dia. holes for fixing screws and chrome-plated body
2KA 001 386-281	2	with distance base and fixing material, black body, 2 AM4 x 40 fixing screws
2KA 001 386-497	120	with distance base and fixing material, black body, 2 AM4 x 40 fixing screws, with loss-protection for fixing screws
2KA 001 386-291	2	with distance base and fixing material, chrome-plated body, 2 AM4 x 40 fixing screws
2KA 001 386-301	2	with distance base and fixing material, grey body, 2 AM4 x 40 fixing screws
Spare parts/Accessories:		
9BG 101 230-001	2	Body with lens, black
9BG 101 230-011	2	chrome-plated
9GT 005 166-001	10	Grommet
8GM 002 092-121	10	C5W bulb, 12V

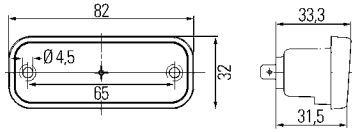

For side flush mounting

Clear lens.

Black plastic body, with rubber gasket.
Two 4.5 mm dia. holes for fixing screws.

Part no.	Pk.	
2XS 003 738-037	40	Clearance light
Spare parts:		
8GM 002 092-121	10	C5W bulb, 12V

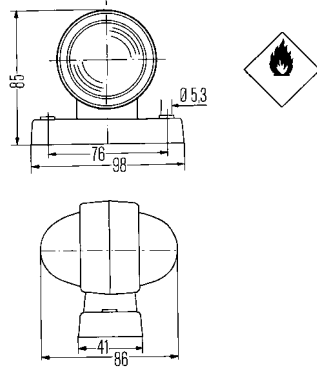

For upright mounting

Front-facing part of lens frosted white, rear-facing part red, provided loose.

Black rubber body. Light is pre-wired.
Two 5.3 mm dia. holes for fixing screws.

Part no.	Pk.	
2XS 955 031-001	2	Clearance light
Spare parts/Accessories:		
9EL 950 315-061	5	red, for upright mounting
9EL 950 315-001	5	red, for pendant mounting
9EL 950 315-031	5	frosted white R5W bulb,
8GA 002 071-121	10	12V
8GA 002 071-241	10	24V

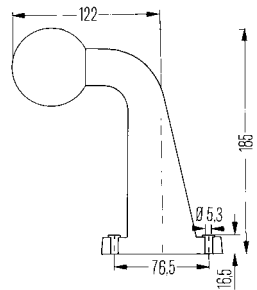

2XS 950 071-031	2	Clearance light with rubber arm
Spare parts/Accessories:		
9EL 950 315-061	5	red
9EL 950 315-031	5	frosted white
8KA 950 073-001	10	with plastic bulb holder
8KA 962 886-001	10	with metal bulb holder
8GA 002 071-121	10	12V
8GA 002 071-241	10	24V

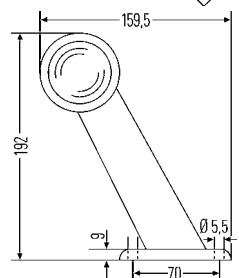

2XS 955 232-001	2	Clearance light With straight rubber arm and 75 mm lead
with straight rubber arm, 150 mm cable with flute tube, crimped blade connectors 6.3 mm and mounted plug body like AMP		
Spare parts/Accessories:		
9EL 950 315-061	5	red
9EL 950 315-031	5	frosted white
8KA 950 073-001	10	with plastic bulb holder
8KA 962 886-001	10	with metal bulb holder
8GA 002 071-121	10	12V
8GA 002 071-241	10	24V

For side mounting on trailer

Rear-Logic

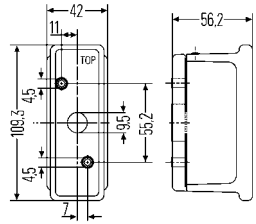

Front-facing part of lens clear, rear-facing part red, side marker light with integrated amber reflector.

Black plastic body, with grommet.

Two 4.5 mm dia. holes for fixing screws.

When the light is used on towing vehicles it is necessary to replace the glass-clear lens with a black lens 9EL 148 673-021, as accessory available.

Part no.	Pk.	
2XS 007 841-011	10	Clearance-side marker light with reflector, left
2XS 007 841-017	104	
2XS 007 841-021	10	Clearance-side marker light with reflector, right
2XS 007 841-027	104	
Spare parts/Accessories:		
9EL 146 838-001	2	Side-marker light
9GT 005 166-001	10	Grommet
9EL 148 673-021	2	Lens, black R10W bulb,
8GA 002 071-131	10	12V
8GA 002 071-251	10	24V

For side upright attachment on trailer

Mounting on trailer with box body is prohibited.

Front-facing part of lens clear, rear-facing part red (not mounted), for side marker light with integrated amber reflector (mounted).

Black rubber body.

Four 5.3 mm dia. holes for fixing screws.

When the light is used on towing vehicles it is necessary to replace the glass-clear lens with a black lens 9EL 964 291-001, as accessory available.

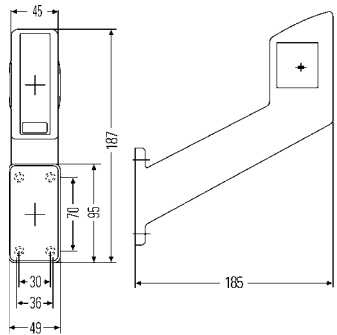

Part no.	Pk.	
2XS 955 260-001	2	Clearance-side marker light with reflector
2XS 955 260-007	50	
Spare parts/Accessories:		
9EL 964 289-001	10	Lens, clear
9EL 964 290-001	10	red
8RA 964 292-001	10	Reflector, amber
9EL 964 291-001	10	Lens, black R5W bulb,
8GA 002 071-121	10	12V
8GA 002 071-241	10	24V

For side-rear mounting

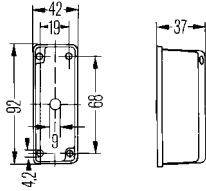

Part no.	Pk.	Description
2XS 005 020-001	10	Clearance light with two ST3.5 x 16-C fixing screws and grommet, without bulb, front-facing part of lens clear, rear-facing part red
2XS 005 020-002	90	
2XS 005 020-003	1	
		Pro-fit pack



2XS 005 020-057	1	Clearance light with two ST3.5 x 16-C fixing screws, grommet and 12V bulb, front-facing part of lens clear, rear-facing part red
-----------------	---	--



2XS 005 020-137	168	Clearance light without fixing screws and grommet, with 8.2 mm dia. hole for wire and 12V bulb front-facing part of lens clear, rear-facing part red
-----------------	-----	--



2XS 005 020-041	10	Clearance light with two ST3.5 x 16-C fixing screws and 8.2 mm dia. hole for wire, without grommet, front-facing part of lens black, rear-facing part red
2XS 005 020-047	168	



2XS 005 020-081	2	Clearance light with two ST3.5 x 16-C fixing screws, 9 mm dia. hole for wire and grommet front-facing part of lens black, rear-facing part red
-----------------	---	--



2XS 005 020-077	8	Clearance light with two ST3.5 x 16-C fixing screws and 8.2 mm dia. hole for wire, without grommet, front-facing part of lens clear, rear-facing part black
-----------------	---	---

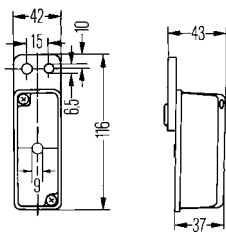

2XS 005 020-011	10	Clearance light with flexible rubber support 55 x 42 mm and grommet, front-facing part of lens clear, rear-facing part red
2XS 005 020-017	140	



2XS 005 020-067	6	Clearance light with flexible rubber support 55 x 42 mm, without grommet, for PG9-cable retention, front-facing part of lens clear, rear-facing part red
-----------------	---	--



2XS 005 020-147	1	Clearance light with flexible rubber support 55 x 42 mm and grommet, front-facing part of lens clear, rear-facing part black
2XS 005 020-091	2	

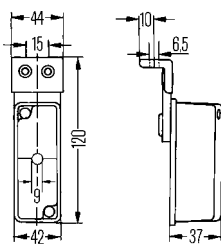

2XS 005 020-021	10	Clearance light with grommet and rubber holder with fixing angle, front-facing part of lens clear, rear-facing part red
2XS 005 020-111	2	
2XS 005 020-121	1	

Spare parts/Accessories:		
Lens with screws,		
9EL 132 215-001	2	front-facing part clear, rear-facing part red
9EL 132 215-011	2	front-facing part black, rear-facing part red
T4W bulb,		
8GP 002 067-121	10	12V
8GP 002 067-241	10	24V

For side mounting

For caravans.

Lens is arrested on base plate.

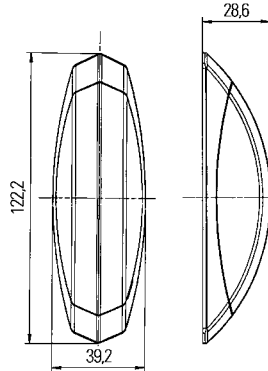

Part no.	Pk.	
2XS 008 479-061	1	Clearance light front-facing part of lens clear, rear-facing part red, without bulb, with dark grey base plate, left
2XS 008 479-071	1	
2XS 008 479-001	1	Clearance light front-facing part of lens clear, rear-facing part red, with 12V bulb, with dark grey base plate, left
2XS 008 479-007	90	
2XS 008 479-011	1	right
2XS 008 479-017	90	
2XS 008 479-081	1	Clearance light front-facing part of lens clear, rear-facing part red, with 12V bulb, with light grey base plate, left
2XS 008 479-087	90	
2XS 008 479-091	1	right
2XS 008 479-097	90	
2XS 008 479-041	1	Clearance light front-facing part of lens clear, rear-facing part red, with 24V bulb, with dark grey base plate, left
2XS 008 479-047	90	
2XS 008 479-051	1	right
2XS 008 479-057	90	
2XS 008 479-107	90	Clearance light front-facing part silver coloured, rear-facing part of lens red, with 12V bulb, with light dark base plate, left
2XS 008 479-117	90	
8GM 002 092-121	10	Spare parts: C5W bulb, 12V
8GM 002 092-241	10	

5

For side, horizontal or vertical surface mounting

For horizontal or vertical surface mounting on trailers and semi-trailers with box body.

With 2 red LEDs and grommet.

Lens clear. With LED light guide technology.

Consumption: 0.06A at 12V/24V.

Grey plastic base plate and covers.

Two 5.4 mm dia. holes for fixing screws.

for fixing screws.

See LED instruction 2.

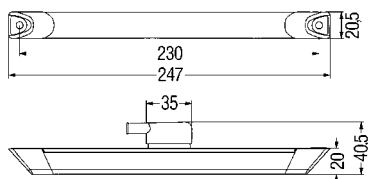

Part no.	Pk.	
2XS 008 078-011	1	Clearance light, 12V0.7W
2XS 008 078-001	1	
2XS 008 078-007	60	

For side mounting

Front-facing part of lens frosted white.
National type test for Germany

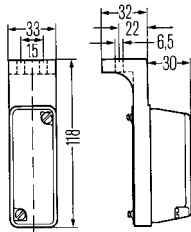
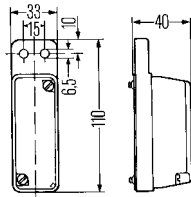
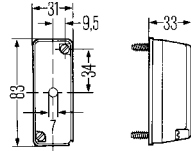

Part no.	Pk.	
2XS 003 168-071	2	Track-control light with two 3.9 x 32 fixing screws
2XS 003 168-081	2	with flexible rubber support and two 6.5 mm dia. holes for fixing screws
2XS 003 168-131	2	with rubber holder for surface-fitting and two 6.5 mm dia. holes for fixing screws
8GM 002 092-121	1	Accessories: C5W bulb, 12V
8GM 002 092-241	1	

For mounting to vertical and horizontal surfaces

Bracket with M8 fixing screw.

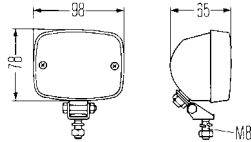

Part no.	Pk.	
		Red lens.
2NE 003 030-151	1	Rear fog light (NES 100) with chrome-plated body
2NE 003 030-167	12	Rear fog light (NES 100) with 12 bulb and matt black body
		Spare parts/Accessories:
		P21W bulb,
8GA 002 073-121	10	12V
8GA 002 073-241	10	24V
		Clear lens.
2ZR 003 030-171	1	Reverse light (ZR 100) with chrome-plated body
		Spare parts/Accessories:
		Lens with screws
9EL 122 268-001	1	P21W bulb,
8GA 002 073-121	10	12V
8GA 002 073-241	10	24V



Bracket with M8 fixing screw.

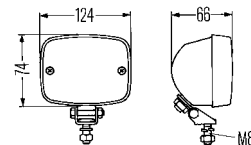

Part no.	Pk.	
		Red lens.
2NE 002 985-001	1	Rear fog light (NES 80) with black body
		Spare parts/Accessories:
		Lens with screws
9EL 117 094-001	5	P21W bulb,
8GA 002 073-121	10	12V
8GA 002 073-241	10	24V
		Clear lens.
2ZR 002 985-081	1	Reverse light (ZR 80) with chrome-plated body
2ZR 002 985-261	1	Reverse light (ZR 80) with black body
		Accessories:
		P21W bulb,
8GA 002 073-121	10	12V
8GA 002 073-241	10	24V



Rear Fog and Reverse Lights



For horizontal or vertical surface mounting

Light unit is horizontally adjustable.

Chrome-plated body. Two 5.5 mm dia. holes for fixing screws.

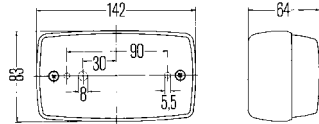

Part no.	Pk.	
Red lens.		
2NE 002 589-001	1	Rear fog light (NES 5)
Spare parts/Accessories:		
9EL 112 763-001	5	Lens with screws
8GA 002 073-121	10	P21W bulb, 12V
Clear lens.		
2ZR 002 589-011	1	Reverse light (ZR 5)
Spare parts/Accessories:		
9EL 112 858-011	2	Lens with screws
8GA 002 073-121	10	P21W bulb, 12V

For horizontal surface mounting

Black plastic body and rim.

Two B4.8 x 19 fixing screws.

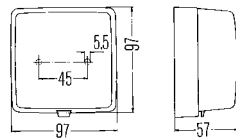

Part no.	Pk.	
Red lens.		
2NE 003 315-011	1	Rear fog lights (NES 9)
Spare parts/Accessories:		
9EL 119 977-001	1	Lens
8GA 002 073-121	10	P21W bulb, 12V
Clear lens.		
2ZR 003 315-041	1	Reverse light (ZR 9)
Accessories:		
8GA 002 073-121	10	P21W bulb, 12V

For surface or flush mounting

Black plastic body.
Two 5.2 mm dia. holes for fixing screws.

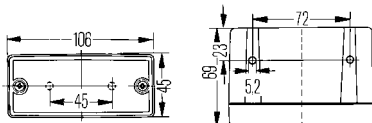
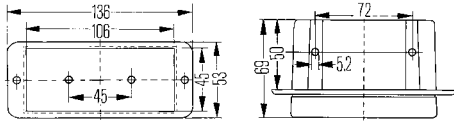

Part no.	Pk.	
		For horizontal or vertical flush mounting. Red lens.
2NE 006 609-017	25	Rear fog light
2NE 006 609-011	1	Rear fog light Pro-fit pack
		Spare parts/Accessories:
9EL 141 612-001	10	Lens
8GA 002 073-121	10	P21W bulb, 12V
		For horizontal or vertical flush mounting. Clear lens.
2ZR 006 609-171	1	Reverse light
		Accessories:
8GA 002 073-121	10	P21W bulb, 12V
		For horizontal or vertical attachment at rear or vertical attachment on side of passenger car trailer. Red lens.
2NE 006 609-007	30	Rear fog light
2NE 006 609-001	1	Rear fog light Pro-fit pack
2NE 006 609-187	30	Rear fog light without 12V bulb
		Spare parts/Accessories:
9EL 141 612-001	10	Lens
8GA 002 073-121	10	P21W bulb, 12V
		For rear surface mounting. Clear lens.
2ZR 006 609-087	30	Reverse light
2ZR 006 609-081	1	Reverse light Pro-fit pack
		Accessories:
8GA 002 073-121	10	P21W bulb, 12V

Rear Fog and Reverse Lights



For flush mounting

Red PC lens with reflector.

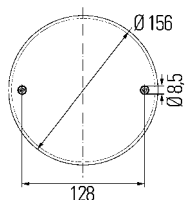
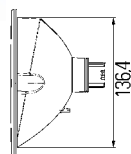

Part no.	Pk.	
		With 12V bulb, 200 mm connecting lead and 6,3 mm blade receptacles.
2NE 344 610-007	36	Rear fog light
8GA 002 073-121	10	Spare parts: P21W bulb, 12V
8RA 344 610-017	45	Reflector

For upright or pendant mounting

With AMP plug connector and 24V bulb.

Black fibre-glass reinforced plastic body.
With M10 fixing screw and vibration damping.
Type of protection: IP6K4K und IPX9K.

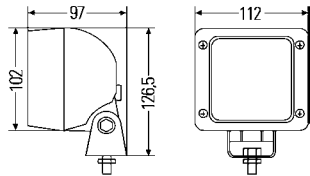

Part no.	Pk.	
2ZR 997 506-391	1	Reverse light (Ultra Beam FF®) with clear lens
2ZR 996 506-501	1	with clear lens, half of lens without optical pattern
2ZR 997 506-621	1	
Spare parts/Accessories:		
9GH 993 984-001	20	Cap for AMP plug connector
8JD 008 151-011	10	Socket for AMP plug connector
8KB 990 299-001	1	2000 mm long lead for AMP plug connector
8KW 701 235-033	100	Blade receptacles 6.3 mm H3 bulb,
8GH 002 090-133	1	12V
8GH 002 090-251	1	24V

For upright mounting

Clear lens without optical pattern.

With 500 mm lead and 24V bulb.

Black plastic body.
Pivot base with M10 fixing screws.
Type of protection: IP5K9K.

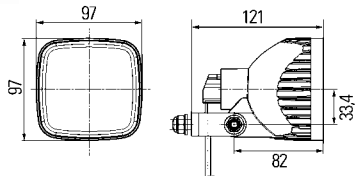

Part no.	Pk.	
2ZR 996 179-701	1	Reverse light (ECO 21)
Spare parts/Accessories:		
		P21W bulb,
8GA 002 073-121	10	12V
8GA 002 073-241	10	24V

Clear lens.

Black body.

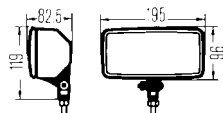

Part no.	Pk.	
2ZR 005 700-191	1	Reverse light (Comet 550)
Spare parts/Accessories:		
9EL 135 000-021	1	Lens
		H3 bulb,
8GH 002 090-133	1	12V
8GH 002 090-251	1	24V

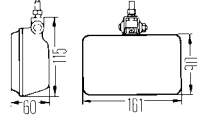

For pendant surface mounting

Clear lens.
Black body.

Part no.	Pk.	
2ZR 005 860-151	1	Reverse light (Comet 450)
9EL 145 660-021	1	Spare parts: Lens
8GH 002 090-133	1	H3 bulb,
8GH 002 090-251	1	12V
		24V

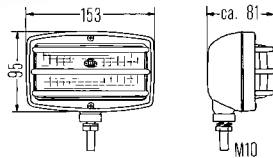

For upright mounting, also for pendant attachment after turning insert

Clear lens.
Black body, chrome-plated rim and protective grill.
Spherical base with M10 x 1 hollow screw.

Part no.	Pk.	
2ZR 004 542-001	1	Reverse light (ZR 138)
8GA 002 073-121	10	Accessories: P21W bulb, 12V

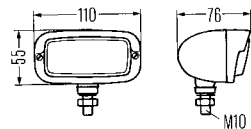

For attachment to bumper or horizontal surfaces

Clear lens.
Chrome-plated body and rim. Spherical base with M10 hollow screw.

Part no.	Pk.	
2ZR 001 193-011	1	Reverse light (ZR 92)
8GA 002 073-121	10	Accessories: P21W bulb, 12V

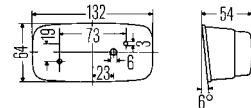

For horizontal surface mounting

Clear lens. With 12V bulb.
Chrome-plated rim. Two B4.2 x 13 fixing screws.

Part no.	Pk.	
2ZR 002 694-001	1	Reverse light (ZR 106)
2ZR 002 694-002	1	Carded
9EL 113 928-001	2	Spare parts: Lens with screws
8GA 002 073-121	10	P21W bulb, 12V

For stick-down attachment to inside surface

In Matrix-technology. Red lens.
With 12V bulbs and mounting accessories.
 Black body. For rear window inclination 26° - 75°.

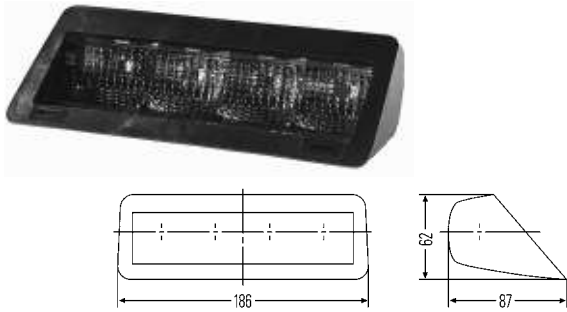

Part no.	Pk.	
2DA 007 428-001	1	Safety brake light
2DA 007 428-007	40	
Spare parts:		
8GP 003 594-121	10	W5W bulb, 12V

In LED-technology. With 16 red LEDs 12V3.0W and 3000 mm lead. Clear lens.
 For rear window inclination 25° - 67°.
 Consumption: 0.25A at 12V. See LED instruction 2.

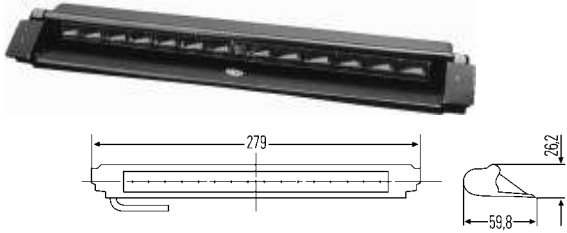

Part no.	Pk.	
2DA 007 592-101	1	Safety brake light

For surface-mounting on boot lid or vehicle roof

In Matrix-technology. Red lens.
With 12V bulbs and mounting accessories.

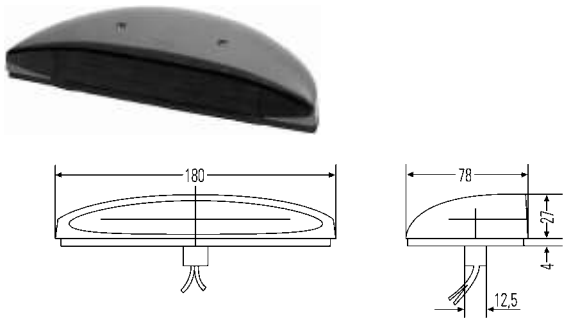

Part no.	Pk.	
2DA 007 541-001	1	Safety brake light
Spare parts:		
8GP 003 594-121	10	W5W bulb, 12V

For flush mounting in rear spoiler

In Matrix-technology. Red lens. With 12V bulbs.
Black body. Without lead.

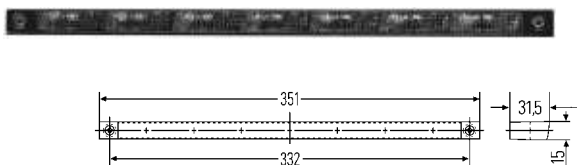
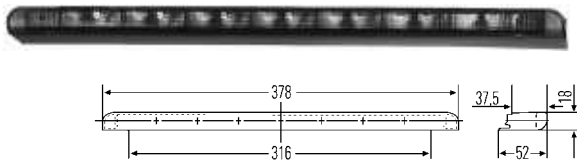
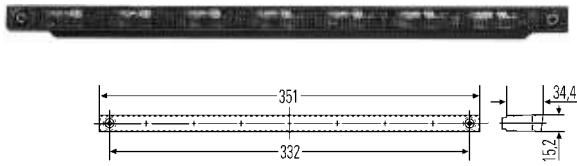

Part no.	Pk.	
		Two B3.9 x 22 fixing screws with red head.
2DA 007 421-001	1	Safety brake light to screw attachment from the front
2DA 007 421-007	56	
		With rounded lens. Two B3.9 x 22 fixing screws with red head.
2DA 007 421-017	1	Safety brake light for screw-attachment from below
2DA 007 421-027	1	Safety brake light to screw attachment from the front
		Two 6 mm dia. holes for fixing screws.
2DA 005 739-111	1	Safety brake light to screw attachment from the front
2DA 005 739-117	56	
		Spare parts/Accessories:
		Lead
8KA 144 707-007	56	without gasket
8KA 146 751-007	56	with gasket for electrical connection
9GT 146 757-007	1000	Grommet
8GP 938 026-001	10	W2,3W bulb, 12V



In LED-technology. With 20 red LEDs 12V3.0W. Clear lens.

Consumption: 0.25A at 12V.
Two ST3.9 x 22 fixing screws. Mounting from outside.
See LED instruction 2.

Part no.	Pk.	
2DA 007 858-037	1	Safety brake light
		Accessories:
8KA 146 751-007	56	Lead with grommet

For flush mounting

In LED-technology.
With 20 LEDs 12V3.0W and 3500 mm lead.
Consumption: 0.25A at 12V.
See LED instruction 2.

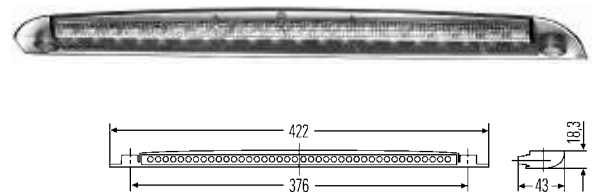

Part no.	Pk.	
2DA 959 380-111	1	Safety brake light with red lens
2DA 959 380-511	1	with grey lens

For flush mounting

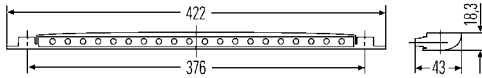

In LED-technology.
With 20 LEDs 12V3.0W and 3500 mm lead.
 Consumption: 0.25A at 12V.
 See LED instruction 2.

Part no.	Pk.	
2DA 959 580-151	1	Safety brake light with red lens
2DA 959 580-551	1	with grey lens

In LED-technology. With 12 LEDs and 2500 mm lead.
 Consumption: 0.16A at 12V, 0.08A at 24V.
 See LED instruction 2.

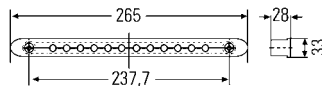
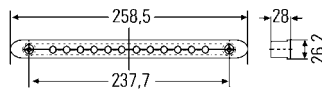

Part no.	Pk.	
2DA 959 071-037	1	Safety brake light with clear lens, 12V2.0W
2DA 959 071-237	1	with clear lens, 24V2.0W
2DA 959 071-537	1	with red lens, 12V2.0W
2DA 959 071-737	1	with red lens, 24V2.0W
2DA 959 071-757	10	with installation material and red lens, 24V2.0W

For flush mounting in caravan-trailers and mobile homes

In Matrix-technology. Red lens. With 12V bulbs.

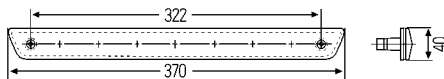

Part no.	Pk.	
2DA 008 136-007	60	Safety brake light with screw-connected to the body
2DA 008 136-017	60	without screws, with screw-connected to the lens
2DA 008 136-027	60	with PE foam gasket coated with glue on both sides
2DA 008 136-031	1	with body, wiring harness and sealant
9HB 152 021-007	60	Spare parts/Accessories: Cover for -007 for wall thickness 10 mm
8KA 146 751-007	56	Lead with grommet
8KA 144 707-007	56	without grommet
9GT 146 757-007	1000	Grommet
9BG 154 271-001	2	Body
8GP 938 026-001	10	T5/13,5 bulb, 12V

For horizontal or vertical surface mounting

In LED-technology. With 10 LEDs and 3000 mm lead.

Consumption: 0.06A at 12V/24V.

See LED instruction 2.

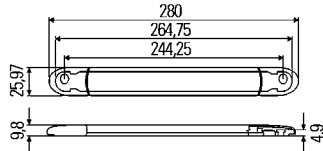

Part no.	Pk.	
		Red lens coloured cap, Two holes 3 mm dia. for fixing screws
2DA 343 106-001	1	Safety brake light, 12V0.7W
2DA 343 106-007	30	
2DA 343 106-011	1	Safety brake light, 24V1.4W
2DA 343 106-017	30	
		Red lens coloured cap, self-adhesive.
2DA 343 106-201	1	Safety brake light, 12V0.7W
2DA 343 106-207	30	
2DA 343 106-211	1	Safety brake light, 24V1.4W
2DA 343 106-217	30	
		Smoked lens coloured cap, two holes 3 mm dia. for fixing screws.
2DA 343 106-021	1	Safety brake light, 12V0.7W
2DA 343 106-027	30	
2DA 343 106-031	1	Safety brake light, 24V1.4W
2DA 343 106-037	30	
		Smoked lens coloured cap, self-adhesive.
2DA 343 106-221	1	Safety brake light, 12V0.7W
2DA 343 106-227	30	
2DA 343 106-231	1	Safety brake light, 24V1.4W
2DA 343 106-237	30	

For horizontal surface mounting

In LED-technology. With 12 LEDs and 200 mm lead.

Red lens with brilliant look with 3D effect by embedding each LED in a separate reflector.

Consumption: 0.15A at 12V, 0.30A at 24V.

Two holes for fixing screws.

See LED instruction 2.

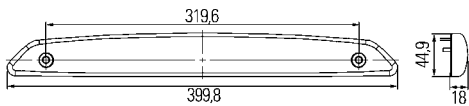

Part no.	Pk.	
2DA 343 800-001	1	Safety brake light, 12V1.8W
2DA 343 800-007	48	
		Safety brake light, seal fixed in place by double-sided adhesive tape, 12V1.8W
2DA 343 800-057	48	
2DA 343 800-047	48	24V3.6W

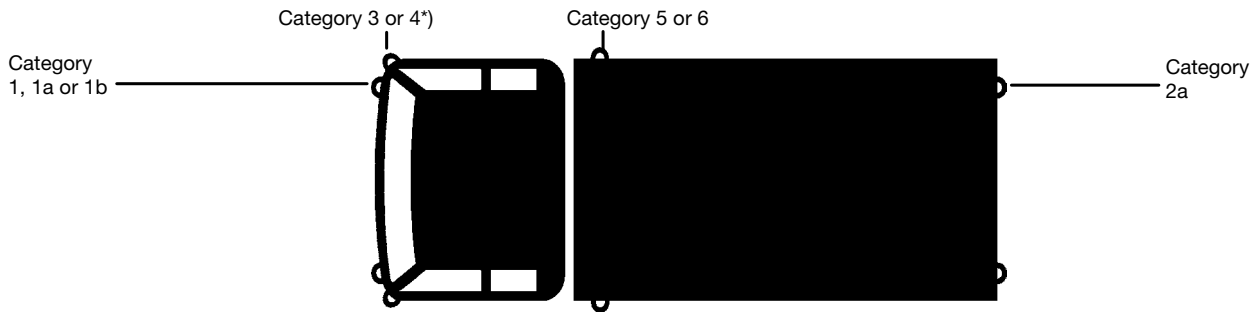

Front direction indicators

Category	Interval to dipped beam headlamp/front fog lamp	Luminous	Direction
1	> 40 mm	min. 175 cd	Towards front
1a	< 40 mm and > 20 mm	min. 250 cd	
1b	< 20 mm	min. 400 cd	

Front side direction indicators

Category	Replaces category	To be mounted with category	Luminous	Direction
3*)	1, 5 and 2a	-	min. 175 cd min. 50 cd	Towards front Towards rear
4*)	1 and 5	2a	min. 175 cd min. 0,6 cd	Towards front Towards rear

Side direction indicators

Category	Replaces category	To be mounted with category	Luminous	Direction
5	-	1 (1a) (1b) and 2a	min. 0,6 cd	Towards rear side
6	-	1 (1a) (1b) and 2a	min. 50 cd	

Rear direction indicators

Category	Remarks	Luminous	Direction
2a	One luminous intensity for day and night	min. 50 cd	Towards rear
2b	at day	min. 175 cd	Towards rear
	at night	min. 40 cd	Towards rear

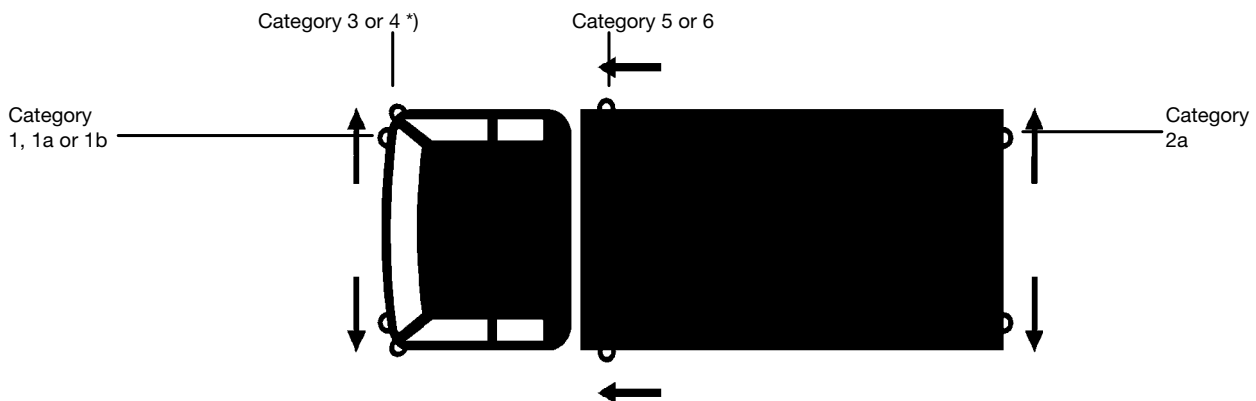

Meaning of arrow on direction indicators

With arrow	Mounting is permissible on one side only (left or right)
Without arrow	Mounting is permissible on left or right

*) Only usable, if vehicle is approved for use in Germany, e.g. farm vehicles and machines.

For horizontal surface mounting

Black plastic body.

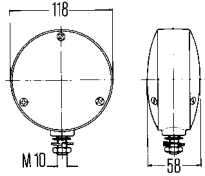

Part no.	Pk.	
		For front, front/side or rear mounting (category 1, 2a, 3 and 4). Amber lens. M10 hollow screw for fixing.
2BA 003 022-021	1	Indicator light without lead
2BA 003 022-001	1	Indicator light with lead
		For rear mounting. Front-facing part of lens black, rear-facing part amber. M10 hollow screw for fixing.
2BA 003 022-057	1	Indicator light with lead and blade terminal contacts
9EL 116 907-001	1	Spare parts/Accessories: Lens
9FT 117 109-007	1500	Bulb holder
8GA 002 073-121	10	P21W bulb,
8GA 002 073-241	10	12V
		24V
		Indicator light for school buses.
2XD 003 022-061	2	Indicator light
9EL 116 907-001	1	Spare parts/Accessories: Lens
9FT 117 109-007	1500	Bulb holder
8GA 002 073-121	10	P21W bulb, 12V

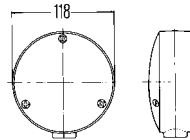

For front, side or rear mounting.

Amber lens.

Two M4 fixing screws.
National type test for Germany.

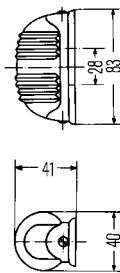

Part no.	Pk.	
2BA 001 227-201	2	Indicator light with chrome-plated rim
2BA 001 227-211	2	without chrome-plated rim
		Spare parts/Accessories: Lens
9EL 074 484-011	1	for -201
9EL 074 484-031	2	for -211
8GM 002 091-121	10	K bulb, 12V

For front, side or rear mounting.

Amber lens.

Die-cast body, silver coloured.
2 M4 fixing screws.
National type test for Germany.

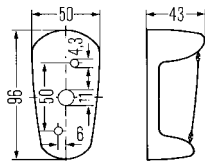

Part no.	Pk.	
2BA 001 248-001	4	Indicator light
		Accessories:
8GM 002 091-121	10	K bulb, 12V

For horizontal surface mounting

Amber lens.

Two holes for M5 fixing screws

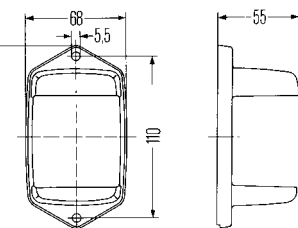
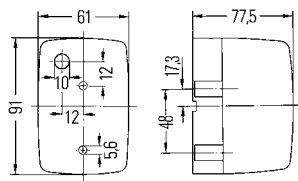
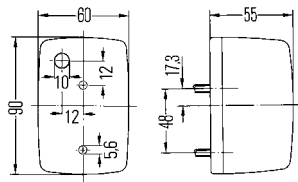
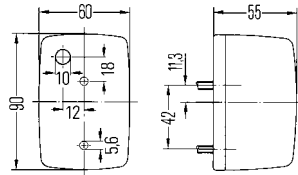

Part no.	Pk.	
		For front mounting (category 1). With grommet.
2BA 002 652-101	2	Indicator light
2BA 002 652-107	96	
		Spare parts/Accessories:
9EL 134 658-001	2	Lens with screw
		P21W bulb,
8GA 002 073-121	10	12V
8GA 002 073-241	10	24V
		For front/side mounting (category 1, 4 and 5). With grommet.
2BA 002 652-111	2	Indicator light, left
2BA 002 652-117	96	
2BA 002 652-121	2	Indicator light, right
2BA 002 652-127	96	
		Spare parts/Accessories:
		Lens with screw,
9EL 134 659-001	2	left
9EL 134 660-001	2	right
		P21W bulb,
8GA 002 073-121	10	12V
8GA 002 073-241	10	24V
		For side mounting. (category 5). With grommet. For Claas.
2BM 002 652-031	1	Auxiliary indicator
		Accessories:
		R5W bulb,
8GA 002 071-121	10	12V
8GA 002 071-241	10	24V
		For side mounting. (category 5). With black base plate. Without grommet.
2BM 002 652-051	1	Auxiliary indicator
		Accessories:
		P21W bulb,
8GA 002 073-121	10	12V
8GA 002 073-241	10	24V
		Silver coloured, for lamps in model range 2BA 002 652-...
8XS 113 389-001	2	Protective cap

For horizontal surface mounting

Amber lens.

Two holes for B4.2 x 9.5 fixing screws.

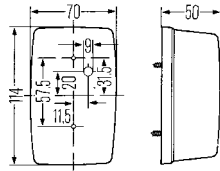

Part no.	Pk.	
For front mounting (category 1).		
2BA 002 324-001	1	Indicator light
Spare parts/Accessories:		
9EL 110 910-001	5	Lens with screws P21W bulb,
8GA 002 073-121	10	12V
8GA 002 073-241	10	24V
For front/side mounting (category 3 and 4 for Germany), with additional filter.		
2BA 002 324-011	1	Indicator light, left
2BA 002 324-021	1	Indicator light, right
Spare parts/Accessories:		
9EL 110 918-001	5	Lens with screws, left P21W bulb,
8GA 002 073-121	10	12V
8GA 002 073-241	10	24V

For front/side mounting (category 4 for Germany).

Amber lens.

Two holes for 4.2 fixing screws.

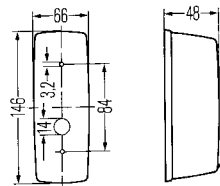

Part no.	Pk.	
2BA 001 277-011	1	Indicator light, left
2BA 001 277-021	1	right
Accessories:		
8GA 002 073-121	10	12V
8GA 002 073-241	10	24V

For front/side mounting (category 1 and 5).

Amber lens.

Two holes for B4.2 x 13 fixing screws.

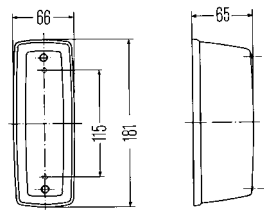

Part no.	Pk.	
2BA 001 221-031	4	Indicator light, left
2BA 001 221-041	4	right
Spare parts/Accessories:		
9EL 110 013-001	4	Lens with screws, left
9EL 110 014-001	4	right
8GA 002 073-121	10	P21W bulb, 12V

For front and rear mounting.

Amber lens.

For Fendt. National type test for Germany



Part no.	Pk.	
2BA 001 244-001	5	Indicator light
Spare parts/Accessories:		
9EL 085 478-001	5	Body with lens
8GM 002 091-121	10	K bulb, 12V

For horizontal surface mounting

For front/side mounting (category 1 and 4).
Amber lens.

Two holes for M6 fixing screws.

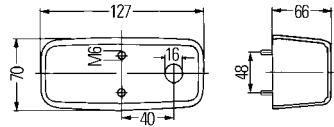

Part no.	Pk.	
2BA 001 416-011	1	Indicator light, left
2BA 001 416-021	1	right
Spare parts/Accessories:		
9EL 110 737-001	2	Lens with screws, left
9EL 110 736-001	2	right
8GA 002 073-121	10	P21W bulb, 12V
8GA 002 073-241	10	24V

For flush mounting

For front or rear mounting (category 1 and 2a).
Amber lens.

Grey plastic body.

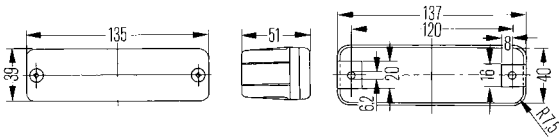

Part no.	Pk.	
2BA 002 939-251	1	Indicator light
Accessories:		
8GA 002 073-121	10	P21W bulb, 12V

For horizontal flush mounting

For front, side or rear flush mounting (category 1, 2a and 5).
Amber lens.

Black plastic body.

Two holes for B4.s or M4 fixing screws.

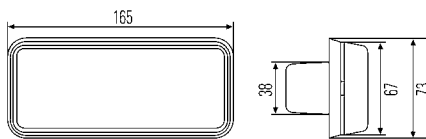

Part no.	Pk.	
2BA 996 027-001	1	Indicator light
Spare parts/Accessories:		
9EL 990 068-001	5	Lens
8GA 002 073-121	10	P21W bulb, 12V
8GA 002 073-241	10	24V

For flush mounting

For front mounting (category 1).

In LED-technology. With 1 LED 3.0W, 200 mm lead and three fixing screws with cover caps.

Type of protection: IP6K. Voltage range: 9V - 33V.

Consumption: 0.25A at 12V, 0.125A at 24V.

See LED instruction 3.

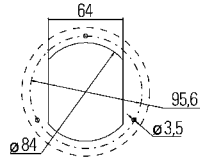
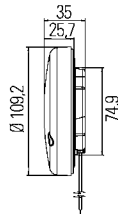

Part no.	Pk.	
2BA 959 932-051	1	Indicator light with clear PC lens
2BA 959 932-011	1	with amber PC lens
2BE 959 932-131	1	Indicator-position light with clear PC lens

For horizontal surface mounting

"Without patented electronics for indicator failure control.

Indicator failure control is not mandatory for lifting loading platforms."

For rear mounting (category 2a) of lifttype loading platforms.

In LED-technology.

With 2 amber LEDs. Clear lens.

Consumption: 0.33A at 12V/24V.

Die-cast zinc body.

Two holes for M6 fixing screws.

With 190 mm potted lead. Type of protection: IP5K9K.

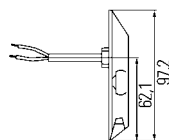
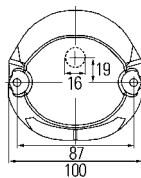

Part no.	Pk.	
2BA 009 204-041	1	Indicator light, 12V4.0W
2BA 009 204-051	1	24V8.0W
2BA 009 204-057	20	

"Without patented electronics for indicator failure control.

Indicator failure control is not mandatory for lifting loading platforms."

For rear mounting (category 2a) of lifttype loading platforms.

In LED-technology.

With 12 amber LEDs 2.8W. Clear lens.

Consumption: 0.24A at 12V, 0.12A at 24V.

Die-cast zinc body. Two M6 fixing screws.

With potted leads. Type of protection: IP5K9K.

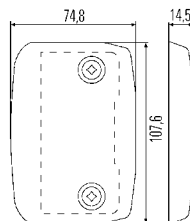

Part no.	Pk.	
2BA 008 260-017	1	Indicator light, 12V
2BA 008 260-001	1	24V
2BA 008 260-007	20	

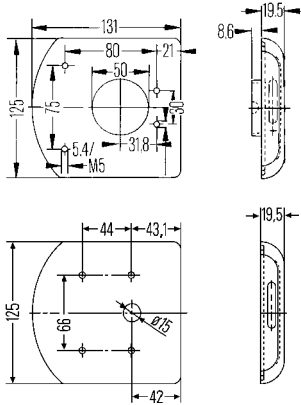

For horizontal surface mounting

For rear mounting (category 2a) of lift type loading platforms.
Amber lens.
Die-cast zinc body.

Part no.	Pk.	
2BA 007 135-001	2	Indicator light with our 5.4 mm dia. holes for fixing screws and PG9-cable retention
2BA 007 135-021	2	without gland
2BA 007 135-011	2	with heavy-duty lens and mounting bolts M5 x 35 extending all the way through
Spare parts/Accessories:		
9EL 146 073-001	6	Lens with reflector for -001/-021
8GP 003 594-121	10	W5W bulb, 12V
8GP 003 594-251	10	W5W bulb, 24V
Also required for installation:		
4AZ 003 787-001	1	Flasher unit, 12V
4AZ 003 787-021	1	Flasher unit, 24V

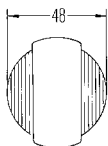
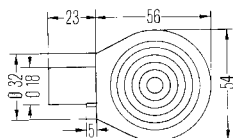

Handlebar indicator lights for two-wheeled vehicles

Amber lens.

Frame polished. Fixed with clamping screw with 17.8 mm dia. pin.
National type test for Germany.

Part no.	Pk.	
2BA 001 236-001	1	Indicator light
Spare parts/Accessories:		
9EL 085 408-001	10	Lens
8GM 002 091-121	10	K bulb, 12V18W

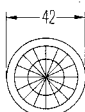
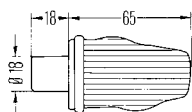

Amber lens.

With 17.8 mm dia. fixing fitting.
National type test for Germany.

Part no.	Pk.	
2BA 001 263-001	4	Indicator light
Accessories:		
8GM 002 091-121	10	K bulb, 12V18W

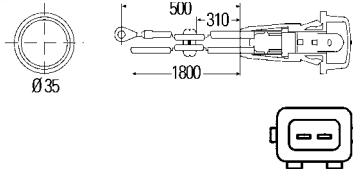

For flush mounting

For side flush mounting (category 5).
Amber lens.

Part no.	Pk.	
2BM 003 563-111	1	Auxiliary indicator with lead
2BM 003 563-217	80	with 100 mm lead, AMP plug connector and 12V bulb
8GP 003 594-121	10	Accessories: W5W bulb, 12V

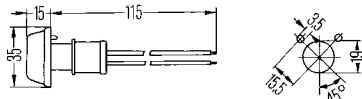

For side flush mounting (category 5).

Set comprises: Two indicators with amber lenses and 12V bulbs.

Part no.	Pk.	
2BM 009 320-807	1	Auxiliary indicator set
8GP 002 067-121	10	Spare parts: T4W bulb, 12V

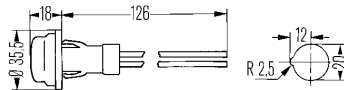

For side flush mounting (category 5).

Set comprises: Two indicators with amber lenses and 12V bulbs.

Part no.	Pk.	
2BM 004 965-801	1	Auxiliary indicator set
8GP 003 594-121	10	Spare parts: W5W bulb, 12V

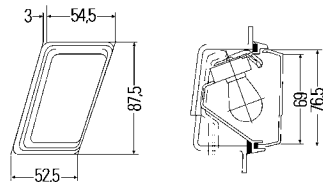

For side flush mounting (category 5).

Amber lens.

Part no.	Pk.	
2BM 004 312-051	1	Auxiliary indicator, left
2BM 004 312-061	1	right
9EL 127 855-001	5	Spare parts/Accessories: Lens, left
9EL 127 856-001	5	right
8GA 002 073-121	10	P21W bulb, 12V
8GA 002 073-241	10	24V

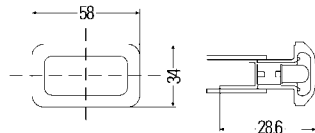

For side flush mounting (category 5).

Amber lens.

Part no.	Pk.	
2BM 003 647-021	1	Auxiliary indicator without bulb
2BM 003 647-067	288	with 12V bulb
2BM 003 647-801	1	Auxiliary indicator set
8GP 003 594-121	10	Spare parts/Accessories: W5W bulb, 12V

Contents:
Two amber indicators with 12V bulbs, lead with two grommets and one cable holder.

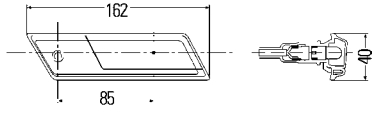

For flush mounting

For side mounting (category 5).
Amber lens, with 2-pole cable.
Black body.

Part no.	Pk.	
2BM 003 933-031	1	Auxiliary indicator, left
2BM 003 933-041	1	right
		Accessories:
8GP 003 594-121	10	W5W bulb, 12V

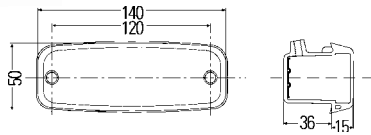

For horizontal surface mounting

For side mounting (category 5).
Amber lens, with lead.

Part no.	Pk.	
2BM 002 847-011	1	Auxiliary indicator, left
2BM 002 847-021	1	right
		Spare parts/Accessories:
9EL 115 830-001	5	Lens
8GA 002 073-121	10	P21W bulb, 12V

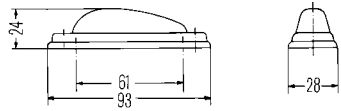

For side mounting (category 5).
Amber lens,
Chrome-plated rim, two M3 fixing screws.

Part no.	Pk.	
2BM 001 318-001	5	Auxiliary indicator
		Accessories:
8GP 002 067-121	10	T4W bulb, 12V

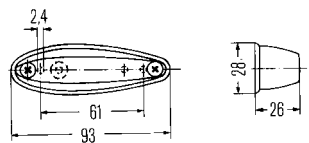

For side mounting (category 5).
Amber lens
Two B2,9 fixing screws.

Part no.	Pk.	
2BM 001 313-001	2	Auxiliary indicator
2BM 001 313-002	1	Pro-fit pack
		Contents: two indicators with amber lenses and 12V bulbs.
		Auxiliary indicator set Pro-fit pack
		Spare parts/Accessories:
8GP 002 067-121	10	T4W bulb, 12V suitable
8GP 002 068-121	10	T8/2 bulb, 12V

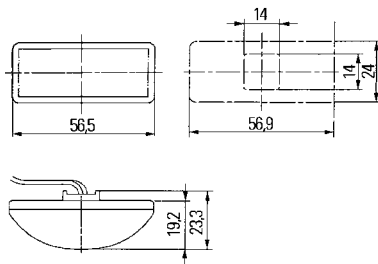

For flush mounting

For side mounting (category 6).
Also suitable for installation in the external mirror.
In LED-technology. Clear lens.
With 3 amber LEDs and 800 mm lead.
 Consumption: 0.06A at 12V.
 Black body. see LED instruction 2.

Part no.	Pk.	
2BM 008 771-001	1	Auxiliary indicator, 12V0.7W
2BM 008 771-007	30	

For horizontal surface mounting

For busses. For side mounting (category 6).
 Black body. Three 3.5 x 35 mm fixing screws.
 For use in splashwater-protected area.

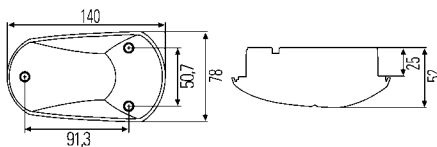

Part no.	Pk.	
		Amber lens.
2BM 008 355-001	1	Auxiliary indicator
2BM 008 355-007	30	
8GA 002 073-241	10	Accessories: P21W bulb, 24V
		Clear lens.
2BM 008 355-017	30	Auxiliary indicator
		Accessories: Cable set, 2-conductor for non-splashwater-protected area, 1200 mm long with two 6.3 mm blade terminals
8KA 157 425-007	1	
8GA 006 841-241	10	PY21W bulb, 24V

For side mounting (category 5 and 6).

Amber lens.
 Two B4,2 x 19 fixing screws.

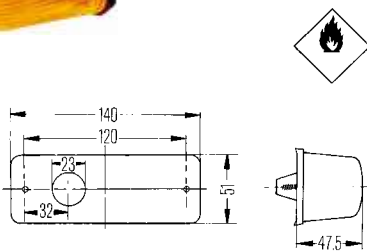

Part no.	Pk.	
2BM 006 692-011	1	Auxiliary indicator, left
2BM 006 692-017	18	
2BM 006 692-021	1	right
2BM 006 692-027	18	
		Accessories: P21W bulb,
8GA 002 073-121	10	12V
8GA 002 073-241	10	24V

For flush mounting

Clear lens.

Four 5.5 mm dia. holes for fixing screws.
With 3-pole AMP-plug.

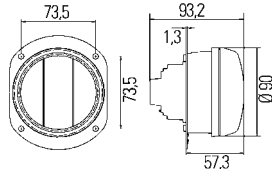

Part no.	Pk.	
		Indicator light with bulb. Position light in LED-technology. Consumption: 0.03A at 12V, 0.04A at 24V.
2BE 010 102-001	1	Indicator-position light with silver colored 12V bulb and 2 white LEDs 0.4W
		Accessories:
9AH 165 968-001	1	Bracket
8JD 162 581-802	1	Plug set



		Indicator light with bulb. Position light in LED-technology. Consumption: 0.04A at 24V.
2BE 010 102-011	1	Indicator-position light with amber 24V bulb and 2 white LEDs 0.85W
		Spare parts/Accessories:
9AH 165 968-001	1	Bracket
8JD 162 581-802	1	Plug set
8GA 006 841-241	10	PY21W bulb, 24V



		Indicator light and daytime running light with bulb technology. Position light in LED technology. Consumption: 0.03A bei 12V.
2BE 010 102-101	1	Indicator, position and daytime running light with white 12V bulb and 2 white LEDs 0.4W
		Spare parts/Accessories:
9AH 165 968-001	1	Bracket
8JD 162 581-802	1	Plug set
8GA 002 073-121	10	P21W bulb, 12V

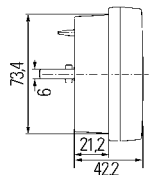
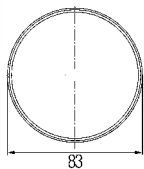

In LED-technology. Clear lens.

With 25 LEDs and 2500 mm long lead.

Indicator light: 4.0W, position light: 1.0W, daytime running light: 4.0W.

Consumption at 24V:

indicator light: 0.17A, position light: 0.04A, daytime running light: 0.17A.

Black plastic body.

One fixing screw 6.3 mm.

Type of protection: IP6K6 and IP6K7.

Part no.	Pk.	
2BE 980 690-101	1	Indicator-side-daytime running light, 24V
		Accessories:
9GD 980 696-001	1	Adapter rim



For horizontal surface mounting

Amber indicator light, white position light.

Die-cast body with black rubber base.
Two M5 fixing screws.
For Massey-Ferguson.
National type test for Germany

Part no.	Pk.	
2BE 001 278-011	1	Indicator-position light, left
2BE 001 278-021	1	right
Spare parts:		
9EL 087 769-001	1	Lens
9FT 087 771-001	5	Bulb holder
8GM 002 094-121	10	M bulb, 12V
8GM 002 091-121	10	K bulb, 12V



For surface mounting

Amber indicator light, white position light.

Two 4,5 mm dia. holes for fixing screws.
For Claas, John Deere, Deutz-Fahr, Fendt.

Part no.	Pk.	
2BE 003 347-001	1	Indicator-position light
Spare parts:		
9EL 120 224-001	5	Body with screw
8GA 002 073-121	10	P21W bulb, 12V
8GA 002 073-241	10	24V
8GM 002 092-121	10	C5W bulb, 12V
8GM 002 092-241	10	24V

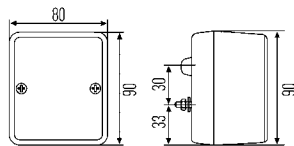

For horizontal surface mounting

Amber indicator light, white position light.

Two fixing screws M4.
For front mounting.

Part no.	Pk.	
2BE 996 029-021	2	Indicator-position light
Spare parts:		
8GA 002 073-121	10	P21W bulb, 12V
8GA 002 073-241	10	24V
8GM 002 092-121	10	C5W bulb, 12V
8GM 002 092-241	10	24V

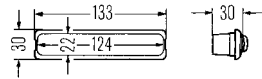

For flush mounting

Clear lens.

Lamp fastened with catch at side.

Part no.	Pk.	
2JA 001 357-002	6	Interior light with switch
2JA 001 357-012	6	without switch
Accessories:		
8GM 002 091-131	10	K bulb, 12V
8GM 002 091-251	10	24V

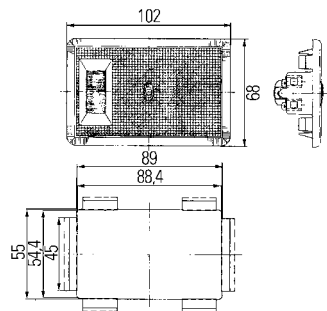

Clear lens.

With rotary switch and 12V bulb.

Clamp fixing.

Part no.	Pk.	
2JA 002 811-027	1	Interior light
Spare parts:		
8GM 002 091-131	10	K bulb, 12V

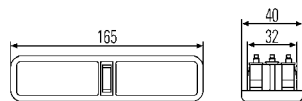

Frosted white lens. With switch.

Part no.	Pk.	
2JA 996 038-001	1	Interior light
Accessories:		
8GM 002 091-131	10	K bulb, 12V
8GM 002 091-251	10	24V

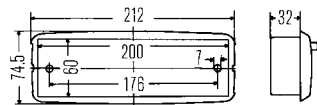

Clear lens.

With switch and ON/OFF door contact.

Two 7 mm dia. holes for fixing screws.

Part no.	Pk.	
2JA 002 661-001	1	Interior light
Spare parts/Accessories:		
9EL 116 607-005	1	Lens
		P21W bulb,
8GA 002 073-121	10	12V
8GA 002 073-241	10	24V

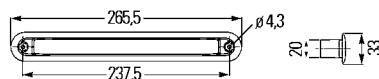

In LED-technology. Clear lens.

With 10 LEDs 1.7W and 2500 mm lead.

Consumption: 0.17A at 12V, 0.09A at 24V.

Part no.	Pk.	
2JA 959 073-001	1	Interior light, 12V
2JA 959 073-201	1	24V

For flush mounting

Clear lens.

Grey body (-041/-251), black body (-087).

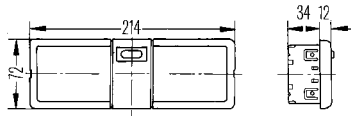
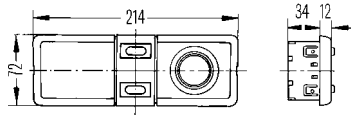

Part no.	Pk.	
2JA 006 447-041	1	Interior light with adjustable spot light and switch for interior light and spot
2JA 006 447-087	30	with adjustable spot, without switch
Accessories:		
8GA 002 073-121	10	P21W bulb for interior light, 12V
8GA 002 073-241	10	24V
8GA 002 071-131	10	R10W bulb for spot light, 12V
8GA 002 071-251	10	24V
<hr/>		
2JA 006 447-251	1	Interior light without spot, with ON/OFF door contact
Accessories optional:		
8GA 002 071-131	10	R10W bulb, 12V
8GA 002 071-251	10	24V
8GA 002 073-121	10	P21W bulb, 12V
8GA 002 073-241	10	24V

Clear lens, with spot.

Switch for interior light and spot.

Grey body.

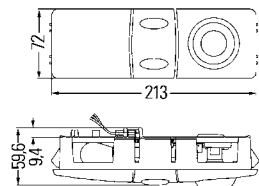

Part no.	Pk.	
2JA 009 037-017	14	Interior light with 12V bulbs
2JA 009 037-027	14	with 24V bulbs
Spare parts:		
8GA 002 073-121	10	P21W bulb for interior light, 12V
8GA 002 073-241	10	24V
8GA 002 071-131	10	R10W bulb for spot light, 12V
8GA 002 071-251	10	24V

Clear lens. With switch and ON/OFF door contact.

Grey body.

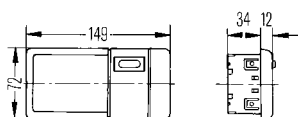

Part no.	Pk.	
2JA 006 487-261	1	Interior light without bulb
2JA 006 487-347	56	with 12V bulb
Spare parts/Accessories optional:		
8GA 002 071-131	10	R10W bulb, 12V
8GA 002 071-251	10	24V
8GA 002 073-121	10	P21W bulb, 12V
8GA 002 073-241	10	24V

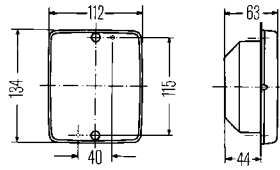

For flush mounting

Clear lens. With economy circuit. It is only permissible for one bulb to be connected.

Grey rubber body. Two BZ4.2 fixing screws.

Part no.	Pk.	
2JA 003 236-357	1	Interior light
		Accessories:
		T4W bulb,
8GP 002 067-121	10	12V
8GP 002 067-241	10	24V

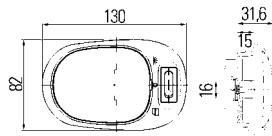

Clear lens. With ON/OFF switch, door contact, 12V bulb and 150 mm lead with 4-pole plug connector.

Plastic body.

Part no.	Pk.	
2JA 964 916-001	1	Interior light with grey switch and transparent body
2JA 964 916-011	1	with black switch and black body
		Accessories:
8GM 002 091-131	10	K bulb, 12V

For flush mounting

SpotLED

In LED-technology. Clear lens.

With 1 white Luxeon Power LED and 200 mm lead.

With adjustable spot, 20° to each side.

Black body. Suitable with screws or spring fixing.

Voltage range: 9V - 31V.

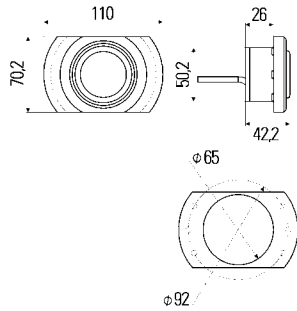

Part no.	Pk.	
2JA 343 700-051	1	<p>Spot: 12V/24V2,5W. Consumption: 0.21A at 12V, 0.10A at 24V.</p> <p>Interior light without Celis® ring light, with white installation frame</p>
2JA 343 700-251	1	<p>Interior light without Celis® ring light, with black installation frame</p>
2JA 343 700-221	1	<p>Spot: 12V/24V2,5W. Consumption: 0.21A at 12V, 0.10A at 24V. Celis® ring light: 12V0.5W, 24V1.0W. Consumption: 0.04A at 12V, 0.02A at 24V.</p> <p>Interior light with blue Celis® ring light and white installation frame</p>
2JA 343 700-271	1	<p>Interior light with blue Celis® ring light and black installation frame</p>
2JA 343 700-167	30	<p>Interior light with red Celis® ring light and black installation frame</p>

For flush mounting

SpotLED

In LED-technology. Clear lens.

With 1 white Luxeon Power LED and 200 mm lead.

With fixed spot.

Black body. Fixing with screws. Voltage range: 9V - 31V.

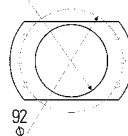
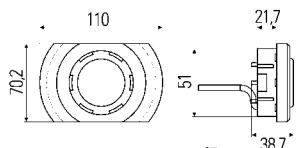

Part no.	Pk.	
		Spot: 12V/24V2,5W. Consumption: 0.21A at 12V, 0.10A at 24V. Celis® ring light: 12V0.5W, 24V1.0W. Consumption: 0.04A at 12V, 0.02A at 24V.
2JA 343 680-177	30	Interior light with blue Celis®ring light and black installation frame
2JA 343 680-127	30	Interior light with blue Celis®ring light and grey installation frame
2JA 343 680-067	30	Interior light with red Celis®ring light and white installation frame

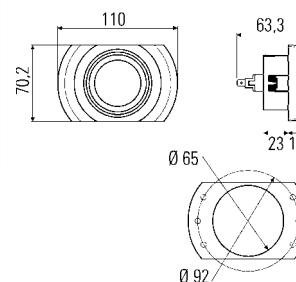

Spot

Clear lens. With 12V5W bulb.

Black body with black installation frame.

Suitable with screw or spring fixing.

Part no.	Pk.	
2JA 343 860-031	1	Interior light with fixed spot
2JA 343 865-031	1	with adjustable spot
8GP 003 594-121	10	Spare parts: W5W bulb, 12V

For flush mounting

SpotLED

In LED-technology. Clear lens.

With 1 white LED.

Spot: 12V2.5W.

Consumption: 0.20A bei 12V.

Suitable with screw or spring fixing.

Electrical connection through 4-pole plug housing.

Type of protection: IP3X. Voltage range: 10V - 31V.

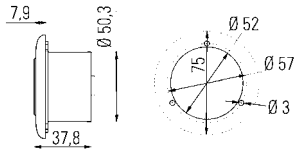

Part no.	Pk.	
2JA 344 040-701	1	Interior light with white installation frame and wide range illumination: 40°
2JA 344 040-741	1	and close range illumination: 20°
2JA 344 040-711	1	Interior light with black installation frame and wide range illumination: 40°
2JA 344 040-751	1	and close range illumination: 20°
2JA 344 040-721	1	Interior light with silver installation frame and wide range illumination: 40°
2JA 344 040-761	1	and close range illumination: 20°
		Accessories:
9AB 959 505-501	1	Metal frame, round, stainless polished
9AB 959 505-561	1	stainless glaze
9AB 344 057-001	1	Plastic frame, round, black
9AB 344 057-011	1	white
9AB 344 057-021	1	silver coloured
9AB 344 058-001	1	Plastic frame, square, black
9AB 344 058-011	1	white
9AB 344 058-021	1	silver coloured

For flush mounting

SpotLED

In LED-technology. Clear lens.

With 1 warm tone LED with adjustable spot.

Spot: 12V/24V2,5W.

Consumption: 0.20A at 12V, 0.10V at 24V.

Celis® ring light: 12V0.5W, 24V1.0W.

Consumption: 0.04A at 12V, 0.02A at 24V.

Suitable with screw or spring fixing.

Electrical connection through 4-pole plug body.

Type of protection: IP3X. Voltage range: 10V - 31V.

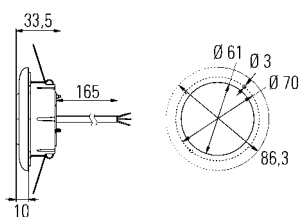

Part no.	Pk.	
2JA 343 790-301	1	Interior light with wide range illumination: 40° and white installation frame, without Celis®ring light
2JA 343 790-701	1	with white Celis®ring light
2JA 343 790-401	1	Interior light with close range illumination: 20° and white installation frame, without Celis®ring light
2JA 343 790-601	1	with white Celis®ring light
2JA 343 790-311	1	Interior light with wide range illumination: 40° and black installation frame, without Celis®ring light
2JA 343 790-711	1	with white Celis®ring light
2JA 343 790-411	1	Interior light with close range illumination: 20° and black installation frame, without Celis®ring light
2JA 343 790-611	1	with white Celis®ring light
2JA 343 790-341	1	Interior light with wide range illumination: 40° and silver installation frame, without Celis®ring light
2JA 343 790-741	1	with white Celis®ring light
2JA 343 790-441	1	Interior light with close range illumination: 20° and white installation frame, without Celis®ring light
2JA 343 790-641	1	with white Celis®ring light
9AB 343 792-061	1	Accessories: Plastic frame, round, with rounded edges, black
9AB 343 792-071	1	golden

For flush mounting

SpotLED

In LED-technology. Clear lens.
 With 1 warm tone LED and adjustable spot.
 Close range illumination: 20°.
 Possible to switch between white functional lighting and blue night design.

Spot: 12V/24V2,5W.
 Consumption: 0.20A at 12V, 0.10V at 24V.
 Celis® ring light: 12V0,5W, 24V1,0W.
 Consumption: 0.04A at 12V, 0.02A at 24V.
 Suitable with screw or spring fixing.
 Electrical connection through 4-pole plug body.
 Type of protection: IP3X. Voltage range: 10V - 31V.

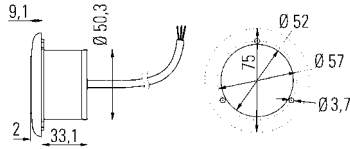

Part no.	Pk.	
2JA 343 790-107	30	Interior light with blue Celis® ring light and white installation frame

In LED-technology. Clear lens.
 With 1 warm tone LED, fixed spot and 200 mm lead.
 Close range illumination: 20°.
 Spot: 12V/24V 2,5W.
 Consumption: 0.20A at 12V, 0.10V at 24V.
 Celis® ring light: 12V0,5W, 24V1,0W.
 Consumption: 0.04A at 12V, 0.02A at 24V.
 Three 3.7 mm dia holes for fixing screws.
 Voltage range: 10V - 31V.

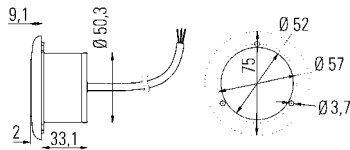

Part no.	Pk.	
2JA 343 980-217	48	Interior light with white Celis® ring light and black installation frame

SpotBulb

Clear lens. With 12V bulb.
 With adjustable spot. Wide range illumination: 35°.
 Electrical connection by blade receptables 6.3 mm.
 Suitable with screw or spring fixing.
 Type of protection: IP3X.

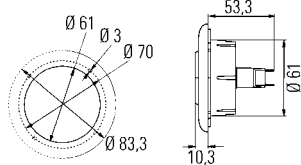

Part no.	Pk.	
2JA 343 795-001	1	Interior light with white installation frame
2JA 343 795-011	1	with black installation frame
2JA 343 795-021	1	with silver installation frame
8GP 003 594-121	10	Spare parts: W5W bulb, 12V

For flush mounting

SpotBulb

Clear lens. With 12V bulb.

With adjustable spot. Wide range illumination: 35°.

Electrical connection by blade receptables 6.3 mm. Screw fixing.

Type of protection: IP3X.

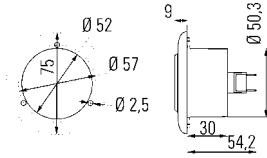

Part no.	Pk.	
2JA 343 985-001	1	Interior light with white installation frame
2JA 343 985-011	1	with black installation frame
2JA 343 985-041	1	with silver installation frame
		Spare parts/Accessories:
9AB 959 505-501	1	Metal frame, stainless polished
9AB 959 505-561	1	stainless glaze
8GP 003 594-121	10	W5W bulb, 12V

For flush/surface mounting

SpotLED Set

In LED-technology. Brilliant clear lens.

Spot: 5V1.5W. Consumption: 0.30A at 5V.

Electrical connection with two leads 500 mm long.

Three 3.7 mm dia. holes for fixing screws. Type of protection: IP20.

4 SpotLED lights with 1 warm white
Power-LED each, 4 attachment frames,
4 sealing rings for flush-mounting and
1 central control unit 5XA 344 150-001.

Technical data central control unit:

Voltage range: 9V - 32V. Output voltage: 3A at 5V.

Number of circuits: 2 with max. 4 SpotLEDs per circuit,
to be dimmed separately. Screw connections.

Power consumption: 1 - 16 W. Type of protection: IP30.



Part no.	Pk.	
2JA 344 190-001	1	Interior light set without Celis® ring light, with white frame
2JA 344 190-011	1	with black frame
2JA 344 190-021	1	with silver frame
Spare parts/Accessories:		
9AB 959 505-501	1	Metal frame, round, stainless polished
9AB 959 505-561	1	stainless glaze
9AB 344 057-001	1	Plastic frame, round, with sharp edges, black
9AB 344 057-011	1	white
9AB 344 057-021	1	silver coloured
9AB 344 057-061	1	chrome-plated
9AB 344 057-071	1	golden
9XD 344 192-061	1	Frame for surface mounting, round, chrome-plated
9XD 344 192-071	1	golden
9AB 344 058-001	1	Plastic frame, square, with sharp edges, black
9AB 344 058-011	1	white
9AB 344 058-021	1	silver coloured
9AB 344 058-061	1	chrome-plated
9AB 344 058-071	1	golden
5XA 344 150-011	1	Central control unit for triggering a maximum of 8 SpotLEDs in a circuit with the additional option of triggering and dimming interior lights up to a maximum power consumption of 70 W via the 2nd circuit

For flush/surface mounting

SpotLED Set

In LED-technology. Clear lens.

Spot: 5V1.5W. Consumption: 0.30A at 5V.

Celis® ring light: 5V0.5W. Consumption: 0.10A at 5V.

Electrical connection with two leads 500 mm long.

Three 3.7 mm dia. holes for fixing screws. Type of protection: IP20.

4 SpotLED lights with 1 warm white
Power-LED each, 4 attachment frames,
4 sealing rings for flush-mounting and
1 central control unit.

Technical data central control unit:

Voltage range: 9V - 32V. Output voltage: 3A at 5V.

Number of circuits: 2 with max. 4 SpotLEDs per circuit,
to be dimmed separately. Screw connections.

Power consumption: 1 - 16 W. Type of protection: IP30.



Part no.	Pk.	
		Interior light set with warm tone Celis® ring light
2JA 344 190-101	1	with white frame
2JA 344 190-111	1	with black frame
2JA 344 190-121	1	with silver frame
		Interior light set with blue Celis® ring light
2JA 344 190-201	1	with white frame
2JA 344 190-211	1	with black frame
2JA 344 190-221	1	with silver frame
		Interior light set with red Celis® ring light
2JA 344 190-301	1	with white frame
2JA 344 190-311	1	with black frame
2JA 344 190-321	1	with silver frame
		Interior light set with orange Celis® ring light
2JA 344 190-351	1	with white frame
2JA 344 190-361	1	with black frame
2JA 344 190-371	1	with silver frame
		Spare parts/Accessories:
9AB 959 505-501	1	Metal frame, round, stainless polished
9AB 959 505-561	1	stainless glaze
9AB 344 057-001	1	Plastic frame, round, with sharp edges, black
9AB 344 057-011	1	white
9AB 344 057-021	1	silver coloured
9AB 344 057-061	1	chrome-plated
9AB 344 057-071	1	golden
9XD 344 192-061	1	Frame for surface mounting, round, chrome-plated
9XD 344 192-071	1	golden
9AB 344 058-001	1	Plastic frame, square, with sharp edges, black
9AB 344 058-011	1	white
9AB 344 058-021	1	silver coloured
9AB 344 058-061	1	chrome-plated
9AB 344 058-071	1	golden
5XA 344 150-011	1	Central control unit for triggering a maximum of 8 SpotLEDs in a circuit with the additional option of triggering and dimming interior lights up to a maximum power consumption of 70 W via the 2nd circuit

For flush/surface mounting

SpotLED

In LED-technology. Brilliant clear lens.

With 1 white Power-LED and fixed spot.

Spot: 5V1.5W. Consumption: 0.30A at 5V.

Electrical connection through 2 x 500 mm cables.

Three 3.7 mm dia. holes for fixing screws. Type of protection: IP20.



Part no.	Pk.	
2JA 344 199-001	1	Interior light without Celis® ring light, with white frame
2JA 344 199-011	1	with black frame
2JA 344 199-021	1	with silver frame
		Accessories:
9AB 959 505-501	1	Metal frame, round, stainless polished
9AB 959 505-561	1	stainless glaze
9AB 344 057-001	1	Plastic frame, round, with sharp edges, black
9AB 344 057-011	1	white
9AB 344 057-021	1	silver coloured
9AB 344 057-061	1	chrome-plated
9AB 344 057-071	1	golden
9AB 344 045-061	1	Plastic frame, round, black
9AB 344 045-071	1	golden
9XD 344 192-061	1	Frame for surface mounting, round, chrome-plated
9XD 344 192-071	1	golden
9AB 344 058-001	1	Plastic frame, square, with sharp edges, black
9AB 344 058-011	1	white
9AB 344 058-021	1	silver coloured
9AB 344 058-061	1	chrome-plated
9AB 344 058-071	1	golden

For flush/surface mounting

SpotLED

In LED-technology. Brilliant-clear lens.

With 1 white Power-LED and fixed spotlight.

Spot: 5V1.5W. Consumption: 0.30A at 5V.

Celis® ring light: 5V0.5W. Consumption: 0.10A at 5V.

Electrical connection through 2 x 500 mm cables.

Three 3.7 mm dia. holes for fixing screws. Type of protection: IP20.



Part no.	Pk.	
		Interior light with warm tone Celis® ring light and white frame
2JA 344 199-101	1	
2JA 344 199-111	1	and black frame
2JA 344 199-121	1	and silver frame
		Interior light with blue Celis® ring light and white frame
2JA 344 199-201	1	
2JA 344 199-211	1	and black frame
2JA 344 199-221	1	and silver frame
		Interior light with red Celis® ring light and white frame
2JA 344 199-301	1	
2JA 344 199-311	1	and black frame
2JA 344 199-321	1	and silver frame
		Interior light with orange Celis® ring light and white frame
2JA 344 199-351	1	
2JA 344 199-361	1	and black frame
2JA 344 199-371	1	and silver frame
		Accessories:
9AB 959 505-501	1	Metal frame, round, stainless polished
9AB 959 505-561	1	stainless glaze
9AB 344 057-001	1	Plastic frame, round, with sharp edges, black
9AB 344 057-011	1	white
9AB 344 057-021	1	silver coloured
9AB 344 057-061	1	chrome-plated
9AB 344 057-071	1	golden
9AB 344 045-061	1	Plastic frame, round, black
9AB 344 045-071	1	golden
9XD 344 192-061	1	Frame for surface mounting, round, chrome-plated
9XD 344 192-071	1	golden
9AB 344 058-001	1	Plastic frame, square, with sharp edges, black
9AB 344 058-011	1	white
9AB 344 058-021	1	silver coloured
9AB 344 058-061	1	chrome-plated
9AB 344 058-071	1	golden

For flush/surface mounting

HighPower SpotLED Set

In LED-technology. Clear lens.

Spot: 5V2.6W. Consumption: 0.50A at 5V.

Celis® ring light: 5V0.5W. Consumption: 0,10A at 5V.

Electrical connection with leads 500 mm long.

Three 3.5 mm dia. holes for fixing screws. Type of protection: IP20.

Contents:

4 SpotLED lights with 1 warm white Power-LED each,
4 attachment frames, 4 sealing rings for flush-mounting and
1 central control unit 5XA 344 150-001.

Technical data central control unit:

Voltage range: 9V - 32V. Output voltage: 3A at 5V.

Number of circuits: 2 with max. 4 SpotLEDs per circuit,
to be dimmed separately. Screw connections.

Power consumption: 1 - 16 W. Type of protection: IP30.

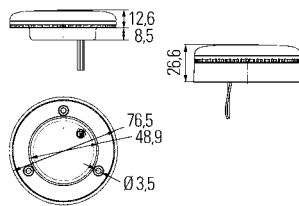

Part no.	Pk.	
2JA 344 590-001	1	Interior light set without Celis® ring light, with white frame
2JA 344 590-011	1	with black frame
2JA 344 590-021	1	with silver frame
2JA 344 590-101	1	Interior light set with warm tone Celis® ring light and white frame
2JA 344 590-111	1	and black frame
2JA 344 590-121	1	and silver frame
		Spare parts/Accessories:
9AB 959 505-501	1	Metal frame, round, stainless polished
9AB 959 505-561	1	stainless glaze
9AB 344 057-001	1	Plastic frame, round, with sharp edges, black
9AB 344 057-011	1	white
9AB 344 057-021	1	silver coloured
9AB 344 057-061	1	chrome-plated
9AB 344 057-071	1	golden
9AB 344 045-061	1	Plastic frame, round, with rounded edges, black
9AB 344 045-071	1	golden
9XD 344 192-061	1	Frame for surface mounting, round, chrome-plated
9XD 344 192-071	1	golden
9AB 344 058-001	1	Plastic frame, square, with sharp edges, black
9AB 344 058-011	1	white
9AB 344 058-021	1	silver coloured
9AB 344 058-061	1	chrome-plated
9AB 344 058-071	1	golden
5XA 344 150-011	1	Central control unit for triggering a maximum of 8 SpotLEDs in a circuit with the additional option of triggering and dimming interior lights up to a maximum power consumption of 70 W via the 2nd circuit

For flush/surface mounting

HighPower SpotLED

In LED-technology. Clear lens.

With 1 white Power-LED and fixed spotlight,
two frames and seal.

Spot: 5V2.6W. Consumption: 0.50A at 5V.

Celis® ring light: 5V0.5W. Consumption: 0.10A at 5V.

Electrical connection with leads 500 mm long.

Three 3.5 mm dia. holes for fixing screws. Type of protection: IP20.

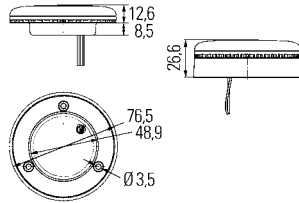

Part no.	Pk.	
2JA 344 599-001	1	Interior light without Celis® ring light, with white frame
2JA 344 599-011	1	with black frame
2JA 344 599-021	1	with silver frame
2JA 344 599-101	1	Interior light with warm tone Celis® ring light and white frame
2JA 344 599-111	1	and black frame
2JA 344 599-121	1	and silver frame
2JA 344 599-201	1	Interior light with blue Celis® ring light and white frame
2JA 344 599-211	1	and black frame
2JA 344 599-221	1	and silver frame
2JA 344 599-301	1	Interior light with red Celis® ring light and white frame
2JA 344 599-311	1	and black frame
2JA 344 599-321	1	and silver frame
2JA 344 599-351	1	Interior light with orange Celis® ring light and white frame
2JA 344 599-361	1	and black frame
2JA 344 599-371	1	and silver frame
9AB 959 505-501	1	Accessories: Metal frame, round, stainless polished
9AB 959 505-561	1	stainless glaze
9AB 344 057-001	1	Plastic frame, round, with sharp edges, black
9AB 344 057-011	1	white
9AB 344 057-021	1	silver coloured
9AB 344 057-061	1	chrome-plated
9AB 344 057-071	1	golden
9AB 344 045-061	1	Plastic frame, round, with rounded edges, black
9AB 344 045-071	1	golden
9XD 344 192-061	1	Frame for surface mounting, round, chrome-plated
9XD 344 192-071	1	golden
9AB 344 058-001	1	Plastic frame, square, with sharp edges, black
9AB 344 058-011	1	white
9AB 344 058-021	1	silver coloured
9AB 344 058-061	1	chrome-plated
9AB 344 058-071	1	golden

For flush mounting

Ambient SpotLED

In LED-technology. Brilliant-clear lens.
With 1 LED 0.3W.

Consumption: 0.025A at 12V/24V

Installation with fixing ring or alternativ 2 holes for ST3.5 fixing screws.

Electrical connection with 4-pole AMP micro plug body.

Operating temperature: -40 °C to + 60 °C. Type of protection: 3X.

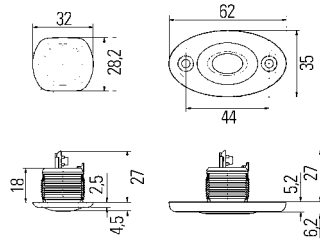

Part no.	Pk.	
2JA 344 170-001	1	Interior light with 3 frames (black, white and grey) and ambient red lighting, 12V
2JA 344 170-101	1	24V
2JA 344 170-011	1	Interior light with 3 frames (black, white and grey) and ambient blue lighting, 12V
2JA 344 170-111	1	24V
2JA 344 170-021	1	Interior light with 3 frames (black, white and grey) and ambient white lighting, 12V
2JA 344 170-121	1	24V
2JA 344 170-031	1	Interior light with 3 frames (black, white and grey) and ambient amber lighting, 12V
2JA 344 170-131	1	24V
2JA 344 170-201	1	Interior light with 3 frames (black, white and silver) and ambient white lighting, 12V

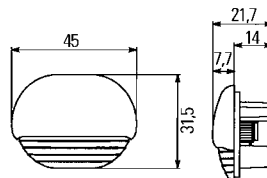

In LED-technology. Clear lens.

Consumption: 0.04A at 12V.

With white cap and 100 mm long lead.

Part no.	Pk.	
2JA 998 560-017	20	Interior light with 1 white LED, 12V0.3W
2JA 998 560-057	20	with 1 blue LED, 12V0.3W

For flush mounting

Mini OvalLED

In LED-technology. Brilliant clear lens.

Consumption: 0.05A at 12V, 0.15A at 24V.

Black body.

Electrical connection through 150 mm long lead.

Operating temperature: -40°C to +60°C.

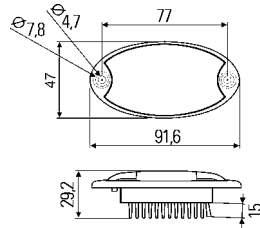

Part no.	Pk.	
2JA 343 570-011	1	Interior light without frame, without switch, 4 white Power LEDs and 1 LED for ambient red lighting, 12V
2JA 343 570-001	1	24V
2JA 343 570-117	48	Interior light without frame, without switch, 4 white Power LEDs and 1 LED for ambient blue lighting, 12V
2JA 343 570-031	1	Interior light without frame, without switch, 4 white LEDs and 1 LED for ambient red lighting, 12V
2JA 343 570-021	1	24V
2JA 343 570-051	1	Interior light with frame, switch, 4 white Power LEDs and 1 LED for ambient red lighting, 12V
2JA 343 570-041	1	24V
2JA 343 570-157	48	Interior light with frame, switch, 4 white Power LEDs and 1 LED for ambient blue lighting, 12V
2JA 343 570-141	1	24V
2JA 343 570-071	1	Interior light with frame, switch, 4 white LEDs and 1 LED for ambient red lighting, 12V
2JA 343 570-061	1	24V

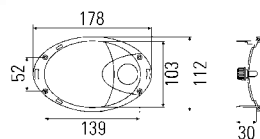
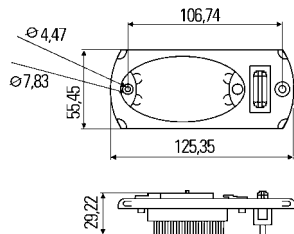

Clear lens.

Black body.

With switch, ON/OFF door contact and blade terminalcontacts.

Suitable with screws or spring fixing.

Operating temperature: - 40 °C to + 60 °C. Type of protection: IP 3.

Part no.	Pk.	
2JA 009 294-001	1	Interior light with 12V bulb, without spot
2JA 009 294-021	1	with 12V bulb and spot
8GP 003 594-121	10	Spare parts: W5W bulb, 12V
2JA 009 294-241	1	with 24V bulb, without spot
2JA 009 294-261	1	with 24V bulb and spot

For flush mounting

CargoLED

In LED-technology. Clear lens.

With 4 white LEDs, 6.0W.

Consumption: 0.5A at 12V, 0.25A at 24V.

Silver-coloured frame with four 4 mm dia. holes for fixing screws.

310 mm long connecting lead with stripped cable ends.

Temperature range: - 40 °C to + 60 °C.

Voltage range: 9V - 31V. Type of protection: IP6K9K.

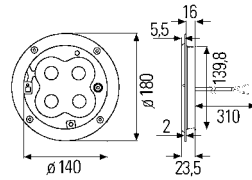

Part no.	Pk.	
2JB 343 227-001	1	Interior light with cold white light
2JB 343 227-041	1	with warm white light
2JB 343 227-047	12	
Accessories:		
9XD 344 118-101	1	Grey mounting frame

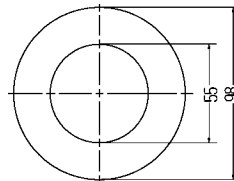

In LED-technology. Clear lens.

With 12 LEDs 12V1.8W.

Consumption: 0.15A at 12V.

Part no.	Pk.	
2PF 008 405-061	1	Interior light with white LEDs
2JA 008 405-081	1	with blue LEDs

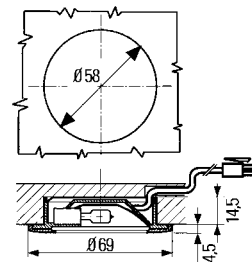

With halogen bulb 12V10W

and 300 mm long connecting lead.

White body with silver-coloured rim.

Part no.	Pk.	
2JA 009 208-001	1	Interior light with frosted white lens
2JA 009 208-011	1	with clear lens

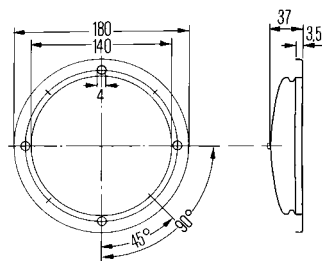

Caution: High temperatures.

Please use silicon leads. The lamp must not come into contact with easily inflammable insulating material!

Clear PC lens.

Steel body and reflector.

Four 4 mm dia. holes for fixing screws.

Part no.	Pk.	
2JA 008 615-001	1	Interior light
Accessories:		
8GA 002 073-241	10	P21W bulb, 24V

For flush mounting

Clear lens, white base plate.
With economy circuit.

Four holes for M4 fixing screws.
 2 x 10W (full power) or 1 x 4W/ 1 x 5W
 (economy circuit) bulbs as required.

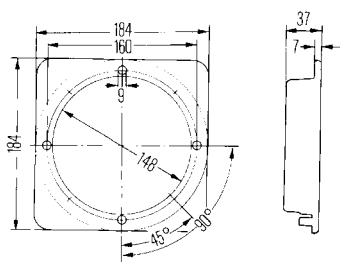
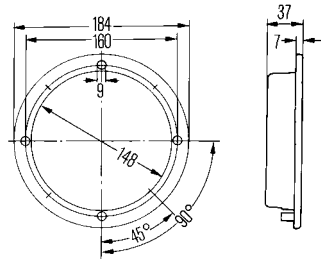

Part no.	Pk.	
2JA 005 590-001	1	Interior light with round frame
2JA 005 590-157	1	with angular frame
		Accessories:
		R10W bulb,
8GA 002 071-131	10	12V
8GA 002 071-251	10	24V
		T4W bulb,
8GP 002 067-121	10	12V
8GP 002 067-241	10	24V
		Halogen bulb if required
8GH 002 473-151	1	12V

For horizontal surface mounting

Mini ThinLED

In LED-technology. Clear lens.

Consumption (-10/11): 0.06A at 12V, 0.1A at 24V.

Consumption (-02): 0.04A at 12V.

Grey base. With 170 mm long lead.

Two holes for M3 fixing screws.

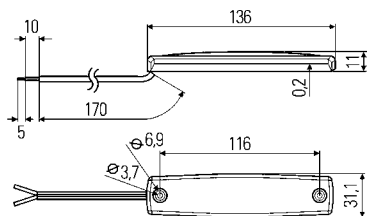

Part no.	Pk.	
2JA 343 660-101	1	Interior light with 5 white LEDs, 12V0.7W
2JA 343 660-107	30	
2JA 343 660-117	30	24V2.3W
2JA 343 660-021	1	Interior light with 3 blue LEDs, 12V0.42W

For horizontal surface mounting

In LED-technology. Clear lens.

Consumption: 0.15A at 12V/24V.
Grey base. With 100 mm long lead.

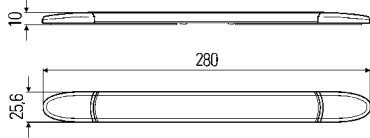

Part no.	Pk.	
2JA 343 606-001	1	Interior light with 10 white LEDs, 12V1.8W
2JA 343 606-007	30	
2JA 343 606-011	1	with 10 white LEDs, 24V3.6W
2JA 343 606-017	30	
2JA 343 606-201	1	with 10 blue LEDs, 12V1.8W
2JA 343 606-217	30	with 10 blue LEDs, 24V3.6W

With LED light guide technology.

Clear lens. With LED light guide technology.

Consumption: 0.06A at 12V.
Grey plastic base plate and covers.
Two 5.4 mm dia. holes for fixing screws.

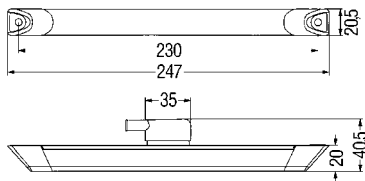

Part no.	Pk.	
2JA 008 078-031	1	Interior light, with 2 white LEDs 12V0.7W

Clear lens, with switch.

Chrome-plated rim.
Two 4.5 mm dia. holes for fixing screws.

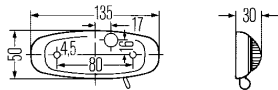

Part no.	Pk.	
2JA 001 346-011	2	Interior light
		Accessories:
8GM 002 091-131	1	K bulb, 12V
8GM 002 091-251	1	24V

Clear lens, with switch.

Chrome-plated body, plastic base plate.

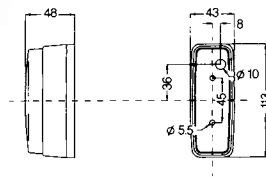

Part no.	Pk.	
2JA 997 027-051	1	Interior light
		Accessories:
8GM 002 091-121	10	K bulb, 12V
8GM 002 091-241	10	24V

Frosted white lens.

Two 5 mm dia. holes for fixing screws.

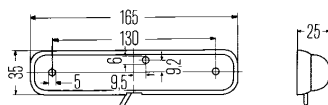

Part no.	Pk.	
2JA 001 330-001	2	Interior light with switch
2JA 001 330-007	102	
2JA 001 330-031	2	without switch
		Accessories:
8GM 002 092-121	10	C5W bulb, 12V
8GM 002 092-241	10	24V

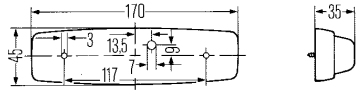

For horizontal surface mounting

Clear lens, with switch.

Switched on and off by sliding the lens.
Chrome-plated rim. Two holes for B4.2 x 13 fixing screws.

Part no.	Pk.	
2JA 001 364-001	2	Interior light
Accessories:		
8GM 002 091-131	10	K bulb, 12V
8GM 002 091-251	10	24V

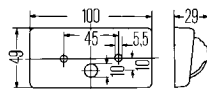

Clear lens, with switch.

Black shutter adjusts light aperture.
Light is switched off mechanically when shutter angle is 45°.
Two 5.5 mm dia. holes for fixing screws.

Part no.	Pk.	
2JA 004 192-001	1	Interior light
Accessories:		
8GM 002 091-131	10	K bulb, 12V
8GM 002 091-251	10	24V

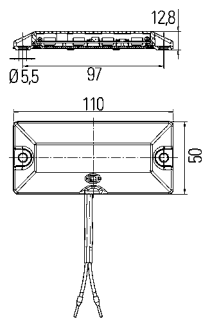

For surface mounting

In LED-technology. Clear lens.

With 4 white LEDs 1.5W and 1300 mm long connecting lead.

Wide range illumination: 40°.

Consumption: 0.06A at 24V.
Black plastic body.
Two 5.5 mm dia. holes for fixing screws.
Type of protection: IP6K9K.

Part no.	Pk.	
2JA 010 838-017	20	Interior light

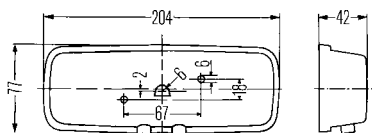

For horizontal surface mounting

Frosted white lens.

with 2 switches. Economy circuit, for switching on 1, 2 or 3 bulbs, as required.

Black body. Two 6 mm dia. holes for fixing screws.

Part no.	Pk.	
2JA 001 360-001	1	Interior light
Accessories:		
8GM 002 091-131	10	K bulb, 12V
8GM 002 091-251	10	24V

For horizontal surface mounting

Clear lens,
two 6 mm dia. holes for fixing screws.

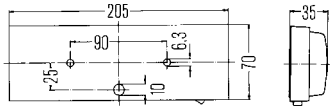

Part no.	Pk.	
2JA 003 354-001	1	Interior light with clear rim and switch
9EL 120 240-011	2	Spare parts/Accessories: Lens
9AR 120 266-001	4	Frame
8GM 002 091-131	10	K bulb, 12V
8GM 002 091-251	10	24V
2JA 003 354-051	1	Interior light with clear rim, without switch
8GM 002 091-131	10	Accessories: K bulb, 12V
8GM 002 091-251	10	24V
2JA 003 354-031	1	Interior light with chrome-plated rim, with switch
8GM 002 091-131	10	Accessories: K bulb, 12V
8GM 002 091-251	10	24V

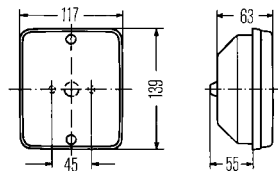

Clear lens, without switch.
Black plastic body.
Two M6 x 12 fixing screws.

Part no.	Pk.	
2ZR 003 236-051	1	Interior light
9EL 119 544-111	1	Spare parts/Accessories: Lens
9DX 119 545-051	2	Reflector P21W bulb,
8GA 002 073-121	10	12V
8GA 002 073-241	10	24V

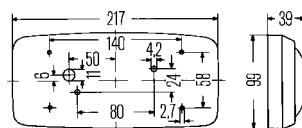

Frosted white lens, chrome-plated rim. Without switch.
Four 3.2 mm dia. holes for fixing screws.

Part no.	Pk.	
2JA 001 331-011	5	Interior light
9EL 091 749-011	5	Spare parts/Accessories: Lens R10W bulb,
8GA 002 071-131	10	12V
8GA 002 071-251	10	24V

For horizontal surface mounting

Clear macrolon lens and frame. With switch.
Switched on and off by rotating the lens. 3 switch positions.
Two holes for M4 fixing screws.

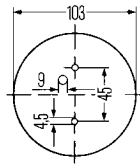

Part no.	Pk.	
2JA 003 231-001	1	Interior light with clear frame
2JA 003 231-011	1	with aluminium-anodized effect rim
Spare parts:		
		K bulb,
8GM 002 091-131	10	12V
8GM 002 091-251	10	24V
		Bulb,
8GM 002 091-141	10	12V
8GM 002 091-261	10	24V

Clear macrolon lens and frame. With switch.
Switched on and off by rotating the lens. 3 switch positions.
Three holes for M4 fixing screws.

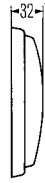
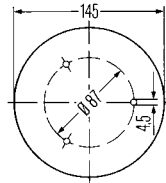

Part no.	Pk.	
2JA 003 232-001	1	Interior light with clear frame
2JA 003 232-011	1	with aluminium-anodized effect rim
Spare parts:		
		K bulb,
8GM 002 091-131	10	12V
8GM 002 091-251	10	24V
		Bulb,
8GM 002 091-141	10	12V
8GM 002 091-261	10	24V

Clear lens.
Chrome-type grille and rim.
Four holes for M4 fixing screws.

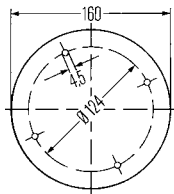

Part no.	Pk.	
2JA 001 335-011	1	Interior light
Accessories:		
		R5W bulb,
8GA 002 071-121	10	12V
8GA 002 071-241	10	24V
		R10W bulb,
8GA 002 071-131	10	12V
8GA 002 071-251	10	24V

Clear lens. With switch and 12V bulb.
Black body.

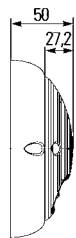
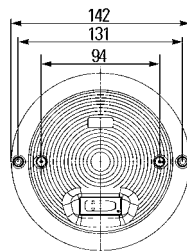

Part no.	Pk.	
2JA 998 569-017	60	Interior light
Spare parts:		
8GA 002 073-121	10	P21W bulb, 12V

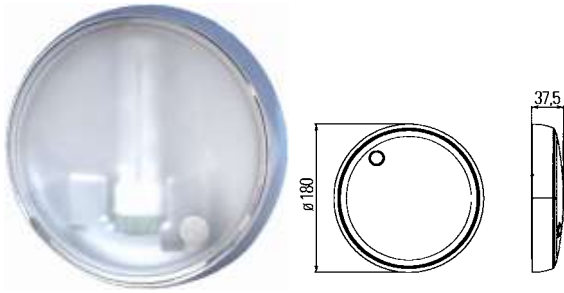

For horizontal surface mounting

Frosted white lens. With 7W fluorescent bulb and 120 mm long connecting lead incl. overvoltage and undervoltage protection.
 Splash-water proof. Three holes for fixing screws.
 Voltage range: 10-30V.

Part no.	Pk.	
2JA 998 565-032	1	Interior light



Clear lens.

With built-in, electronically-operated converter, switch and 8W fluorescent tube. Fully suppressed.
 Blocking diode prevents damage to electronic components caused by incorrect polarity connection.
 Two 3.5 mm dia. holes for fixing screws.

Part no.	Pk.	
2JA 004 531-001	1	Transistorised ceiling light, 12V
2JA 004 531-011	1	24V
Spare parts/Accessories:		
9EL 856 010-001	1	Lens
8GS 002 296-101	1	Fluorescent tube 8W, warm tone
8GS 002 296-111	1	white

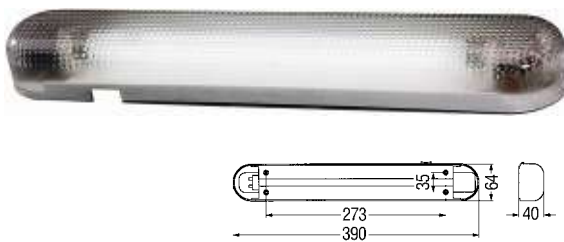

Clear lens. With white 8W fluorescent tube.
RF-suppressed = suppression class N (semi-suppressed).
Power consumption approx. 800 mA.
 White body, without switch.

Part no.	Pk.	
2JA 340 111-001	1	Transistorised ceiling light, 24V
Spare parts:		
8GS 002 296-111	1	Fluorescent tube 8W

For surface mounting

In LED-technology. Clear lens.
With switch. Colour temperature 4000° Kelvin.
Illuminance
 with 12 LEDs 3,5W: 100 lux at a distance of 1 m,
 with 24 LEDs 4,7W: 130 lux at a distance of 1 m,
 with 24 LEDs 7,0W: 200 lux at a distance of 1 m.
Consumption:
 with 12 LEDs 3,5W: 0.3A at 12V, 0.15A at 24V,
 with 24 LEDs 4,7W: 0.4A at 12V, 0.2A at 24V,
 with 24 LEDs 7,0W: 0.6A at 12V, 0.3A at 24V.
 Operating temperature: -40 °C to +60 °C.
 EMV-resistant. Voltage range: 10V - 31V.

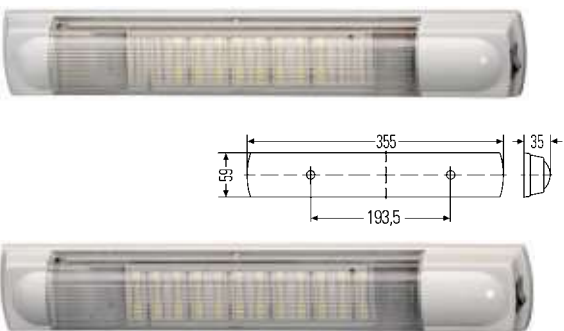

Part no.	Pk.	
2JA 007 373-151	1	Ceiling light with 12 LEDs 3.5W
2JA 007 373-157	30	
2JA 007 373-197	30	with 24 LEDs 4.7W
2JA 007 373-161	1	with 24 LEDs 7.0W

For horizontal surface mounting

**In LED-technology. Clear lens. With 16 LEDs 4.7W.
Without switch. Colour temperature 4000° Kelvin.
Illuminance: 130 lux at a distance of 1 m.**

Consumption: 0.4A at 12V, 0.2A at 24V.
Operating temperature: -40 °C to +60 °C.
EMC-resistant. Type of protection: IP67.

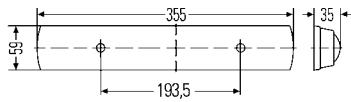

Part no.	Pk.	
2JA 007 373-187	30	Ceiling light, 12V
2JA 007 373-177	30	24V

For horizontal surface mounting

Clear lens.

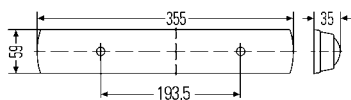
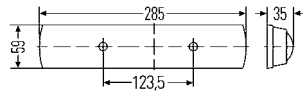
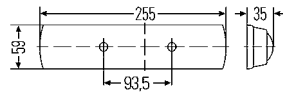
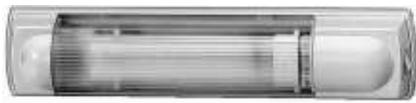

Part no.	Pk.	
2JA 007 373-001	1	Transistorised ceiling light with switch and compact 7W fluorescent tube. Consumption: 300 mA. 12V, fully suppressed
2JA 007 373-011	1	
8GS 861 955-001	1	Spare parts: Compact fluorescent tube 7W, white
2JA 007 373-031	1	Transistorised ceiling light with switch and compact 9W fluorescent tube. Consumption: 385 mA. 12V, fully suppressed
2JA 007 373-041	1	
8GS 861 955-011	1	Spare parts: Compact fluorescent tube 9W, white
2JA 007 373-061	1	Transistorised ceiling light with switch and compact 11W fluorescent tube. Consumption: 550 mA. 12V, fully suppressed
2JA 007 373-071	1	
8GS 861 955-021	1	Spare parts: Compact fluorescent tube 11W, white
2JA 007 373-117	30	Transistorised ceiling light without switch, with compact 11W fluorescent tube. colour temperature 4000° Kelvin. Consumption: 550 mA. 12V, fully suppressed
2JA 007 373-107	30	
2JA 007 373-127	30	Transistorised ceiling light with switch and compact 11W fluorescent tube. colour temperature 4000° Kelvin. Consumption: 550 mA. 12V, fully suppressed
2JA 007 373-137	30	Transistorised ceiling light without switch, with compact fluorescent tube 11W. colour temperature 4000° Kelvin. Consumption: 550 mA, with 2 x 6.3 mm blade receptacles, 24V, fully suppressed
8GS 861 955-031	1	Spare parts: Compact fluorescent tube 11W, white

For horizontal surface mounting

Clear lens.

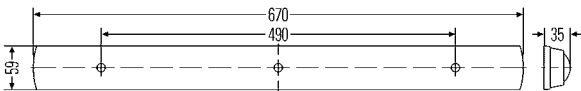
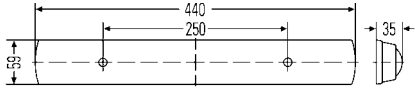

Part no.	Pk.	
2JA 007 372-001	1	Transistorised ceiling light with switch and compact 8W fluorescent tube. Consumption: 390 mA. 12V, fully suppressed
2JA 007 372-011	1	
8GS 002 296-101	1	Spare parts: Compact fluorescent tube 8W, warm tone
8GS 002 296-111	1	
2JA 007 372-041	1	Transistorised ceiling light with switch and compact 13W fluorescent tube. Consumption: 580 mA. 12V, fully suppressed
2JA 007 372-051	1	
8GS 861 953-011	1	Spare parts: Compact fluorescent tube 13W, white

For horizontal surface mounting

Clear lens, black body.

Red lens as accessories available.

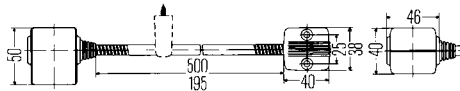

Part no.	Pk.	
2AB 004 532-001	1	Reading light with 500 mm long arm, holder and 12V5W halogen bulb
2AB 004 532-257	40	Reading light with 500 mm long arm, holder, 60 mm long lead, round plug 8KW 044 040-003 and 12V5W halogen bulb.
9XB 136 202-005	1	Spare parts/Accessories: Bracket
8GH 002 473-151	1	Halogen bulb, 12V5W
9EL 128 922-011	10	Red lens
2AB 004 532-061	1	Reading light with 500 mm long arm, holder with 12V4W normal bulb
9XB 136 202-005	1	Spare parts/Accessories: Bracket
8GP 002 067-121	10	T4W bulb, 12V
9EL 128 922-011	10	Red lens
2AB 004 532-051	1	Reading light with 500 mm long arm, holder, and 8V7.5W Xenon bulb
2AB 004 532-057	40	
9XB 136 202-005	1	Spare parts/Accessories: Bracket
8GP 008 285-001	1	Xenon bulb, 28V
9EL 128 922-011	10	Red lens
2AB 004 532-011	1	Reading light with 195 mm long arm, holder, 100 mm long lead and 12V5W halogen bulb
2AB 004 532-267	70	60 mm long lead, round plug 8KW 044 040-003 and 12V5W halogen bulb
8GH 002 473-151	1	Spare parts/Accessories: Halogen bulb, 12V
9EL 128 922-011	10	Red lens
2AB 004 532-031	1	Reading light with 195 mm long arm, holder, 100 mm long lead and 12V5W bulb
8GP 002 067-121	10	Spare parts/Accessories: T4W bulb, 12V
9EL 128 922-011	10	Red lens
2AB 004 532-021	1	Reading light With plug for cigarette lighter socket. 160 mm long arm and 12V5W halogen bulb
8GH 002 473-151	1	Spare parts/Accessories: Halogen bulb, 12V
9EL 128 922-011	10	Red lens

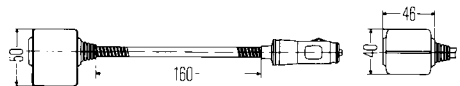

For horizontal surface mounting

SpotLED

In LED-technology.

With flexible arm and screw fixing.

Consumption (one LED): 0.25A at 12V, 0.13A at 24V.

Consumption (two LEDs): 0.20A at 12V, 0.10A at 24V.

Voltage range: 9V - 31V.

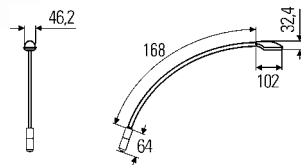
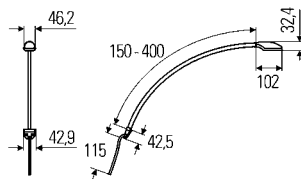

Part no.	Pk.	
2JA 343 720-011	1	Reading light with 1 white LED 3.0W, 115 mm long connecting lead, with white and 150 mm long arm
2JA 343 720-021	1	with black cap and 150 mm long arm
2JA 343 720-291	1	with silver cap and 150 mm long arm
2JA 343 720-111	1	with white cap and 400 mm long arm
2JA 343 720-121	1	with black cap and 400 mm long arm
2JA 343 720-191	1	with silver cap and 400 mm long arm
<hr/>		
2JA 343 720-157	12	Reading light with 1 red LED 3.0W, 115 mm long lead, black cap and 400 mm long arm
<hr/>		
2JA 343 720-511	1	Reading light with 1 white and 1 red LED 2.4W, dimmable with switch, 115 mm long connecting lead, with white cap and 150 mm long arm
2JA 343 720-521	1	black cap and 150 mm long arm
2JA 343 720-531	1	with silver cap and 150 mm long arm
2JA 343 720-611	1	white cap and 400 mm long arm
2JA 343 720-621	1	black cap and 400 mm long arm
2JA 343 720-631	1	silver cap and 400 mm long arm
<hr/>		
2JA 343 720-071	1	Reading light with 1 white LED 3.0W, 2-pole plug for cigarette lighter socket and power sockets, with white cap and 150 mm long arm
2JA 343 720-081	1	with black cap and 150 mm long arm
2JA 343 720-091	1	with silver cap and 150 mm long arm

For horizontal surface mounting

Clear lens. With 12V bulb.
Black plastic body.

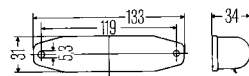
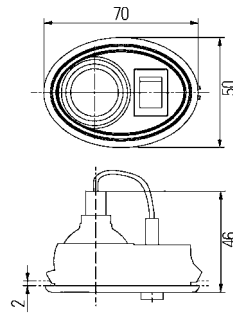
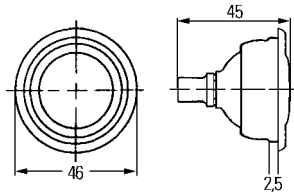

Part no.	Pk.	
2AB 004 074-027	1	Reading light with two 120 mm long leads
8GP 003 594-121	10	Spare parts: W5W bulb, 12V
2AB 004 074-087	90	with 12V bulb, switch and 140 mm lead with 2-pole pin body
8GP 003 594-121	10	Spare parts: W5W bulb, 12V

Black body and anti-glare fitment.
Switched on and off by anti-glare fitment.
Two 5.3 mm dia. holes for fixing screws.

Part no.	Pk.	
2AB 001 208-001	1	Reading light
8GM 002 092-121	10	Accessories: C5W bulb, 12V
8GM 002 092-241	10	24V
8GM 002 091-131	10	K bulb, 12V
8GM 002 091-251	10	24V

Hobby-handlights

With electronic ballast EVG.
 Handle and cap made of blue plastic with flexible rotating hook.
 Impact-proof, oil- and petrol resistant, transparent protective tube.
 With 5000 mm long lead and plain plug.
 Type of protection: IP20, protection class II.
With fluorescent tube, 230V8W.



Part no.	Pk.	
2XM 001 974-151	1	Handlight HL 08-475, 8W, Upgrade, 475 mm long

Professional handlights

With electronic ballast EVG.
 Type of protection: IP64, protection class II.
 With 5000 mm long lead and shaped plug.
 With splinter-proof foil and flexible hook.
With fluorescent lamp 220-240V8W (T5/8W) on plastic rail, replaceable.



Part no.	Pk.	
2XM 008 779-001	1	Handlight HL 08-525, 8W, 525 mm long
Spare parts/Accessories:		
Fluorescent lamp on plastic rail		
8GS 008 823-011	1	-> 6/06
8GS 008 823-041	1	7/06 ->
8HG 861 918-001	1	Magnetic clamp with steel spring



With rectifying ballast GVG.
 Handle and cap made of blue plastic, without hook.
 Impact-proof protective tube.
 Type of protection: IP20.
 With 5000 mm long lead and plain plug.
With fluorescent tube, 230V4W.



Part no.	Pk.	
2XM 001 974-031	1	Handlight HL 04-275, 4W, 275 mm long
Accessories:		
8HG 861 916-001	1	Universal holder
8HG 861 919-001	1	Magnetic holder



With electronic ballast EVG.
 Handle and cap made of blue rubber, with flexible rotating hook,
 PMMA protective tube with splinter-proof foil.
 Oil- and petrol resistant.
 Type of protection: IP64, protection class II.
 With 5000 mm long lead and shaped plug.
With fluorescent lamp 220-240V8W (T5/8W) on plastic rail, replaceable.



Part no.	Pk.	
2XM 001 974-041	1	Handlight HL 08-545, 8W, 545 mm long
Spare parts/Accessories:		
Fluorescent lamp on plastic rail		
8GS 008 823-001	1	
8HG 861 918-001	1	Magnetic holder



Professional handlights

With electronic ballast EVG.
Hexagonal handle and cap made of blue rubber.
With flexible rotating hook made of black plastic.
Impact-proof PMMA protective tube.
Type of protection: IP64, protective class II.
With 5000 mm long lead and shaped plug.

With fluorescent tube, 230V11W, on plastic rail, replaceable.



Part no.	Pk.	
2XM 001 974-051	1	Handlight HL 11-440, 11W, 440 mm long
Spare parts/Accessories:		
8GS 008 822-001	1	PL fluorescent tube on plastic rail
8HG 861 918-001	1	Magnetic holder

With electronic ballast EVG.
Handle, cap and hook made of blue plastic.
Impact-proof, oil- and petrol resistant PMMA protective tube with splinter-proof foil.
With electronic fuse, radio interference suppression and switch-off.
Type of protection: IP64, protection class II.
With 5000 mm long lead and shaped plug.

With fluorescent tube 220-240V13W (T5/13W), replaceable.



Part no.	Pk.	
2XM 001 974-101	1	Handlight HL 13-770, 13W, 770 mm long
Spare parts/Accessories:		
8GS 008 823-031	1	Fluorescent tube
8HG 861 918-001	1	Magnetic holder

With electronic ballast EVG.
Handle, cap and hook made of blue plastic.
Oil- and petrol resistant.
Type of protection: IP64, protection class II.
With 5000 mm long lead and shaped plug.
With electronic fuse, radio interference suppression, switch-off and splinter-proof foil.

With fluorescent tube, 220-240V21W (T5/21W), replaceable.



Part no.	Pk.	
2XM 001 974-111	1	Handlight HL 21-1120, 21W, 1120 mm long
Spare parts/Accessories:		
8GS 008 823-021	1	Fluorescent tube with splinter-proof foil
8HG 861 918-001	1	Magnetic holder

With automatic clamping, quick fastening bracket for bonnets 1100 - 1900 mm.
Tight fit thanks to non-slip profile.
With 5000 mm long lead and shaped plug.

With fluorescent tube, 220-240V21W (T5/21W), replaceable.



Part no.	Pk.	
2XM 001 974-121	1	Handlight HL 21-1120-C, 21W, 1120 mm long
Spare parts:		
2XM 001 974-111	1	Handlamp HL 21-1120
8GS 008 823-021	1	Fluorescent tube with splinter-proof foil



Professional handlights

In LED-technology. With 42 LEDs, 220V-240V.

Protective glass transparent, resistant to oil, petrol and UV-light.
With 5 m lead and shaped plug.
Type of protection: IP64, II.

Part no.	Pk.	
2XM 001 974-201	1	LED handlight



In LED-technology.

Impact-resistant body with rotating hook.
Charger with Euro flat plug 110V-240V.
Charger 12V for cigarette lighter. Type of protection: IP54.
1,5 hour charging time - 5 hours work light.

Part no.	Pk.	
2XM 001 974-211	1	LED handlight with rubber handle, 30 LEDs, 12V battery and charger
2XM 001 974-221	1	extra non-slip rubber handle, 60 LEDs, 12V battery and charger



In LED-technology. With 1 white high-quality, breakproof LED and 3 (AAAA) batteries.

Black body made of aluminium. With flexible swan-neck.
Continuous operation: up to 60 hours. Dustproof and waterproof.
Length: 345 mm, bent: 172 mm.

Part no.	Pk.	
2XM 001 974-181	1	LED inspection light, 345 mm



Professional handlight

With 2 conventional ballast units.
Body and handle made of blue plastic.
With additional socket with hinged cover for connection of additional equipment.
5000 mm lead with earthed plug.
Type of protection: IP54, protection class II.
With two 220-240V24W fluorescent tubes, replaceable.

Part no.	Pk.	
2XM 001 974-131	1	Garage lamp flood light
8GS 008 822-011	1	Spare parts/Accessories: Fluorescent tube, 24W
8XT 863 316-001	1	Tripod height adjustable from 1550 mm to 2550 mm.



Professional handlight

With 2 conventional ballast units.
 Body and handle made of blue plastic.
 With additional socket with hinged cover for connection of additional equipment. 5000 mm lead with earthed plug.
 Type of protection: IP54, protection class II.
With two 220-240V24W fluorescent tubes, replaceable.

Part no.	Pk.	
2XM 009 266-001	1	Garage lamp flood light 24
Spare parts/Accessories:		
8GS 009 469-001	1	Fluorescent tube, 24W
9XD 863 958-001	1	Retaining rail (tripod connection)
8XT 863 316-001	1	Tripod height adjustable from 1550 mm to 2550 mm.

Handlights

With stepless regulation from map to working, from pinpoint to wide-spread light.

Swiveling lamp head.
 Fixing of the lamp with holder or magnet to the bodywork.
 With spirally coiled cable (from 400 up to 3000 mm) and plug 8JA 004 667-001 (Pk. 10) for cigarette lighter socket.

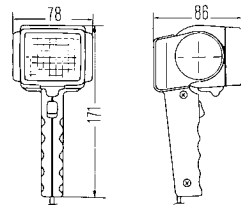

Part no.	Pk.	
2XM 004 444-001	1	Handlight with 12V6W Xenon bulb and plug 8JA 004 667-001 (Pk. 10)
Spare parts:		
8GP 007 676-121	1	Xenon bulb, 12V
8JA 004 667-001	10	Connector
2XM 004 444-011	1	with 28V Xenon bulb and plug 8JA 007 158-001 (Pk.1)
Spare parts:		
8GP 008 285-001	1	Xenon bulb, 28V
8JA 007 158-001	1	Connector

Cockpit and map reading lights for flush mounting

In LED-technology. Clear lens.

Consumption: 0.04A at 12V, 0.02A at 24V.
With white ring for covering the 3 fixing screws.
With 120 mm long lead, gasket and fixing screws.
Dust and water-proof, with polarity reversal protection.
Voltage range: 10V - 33V.

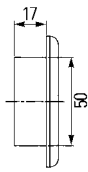
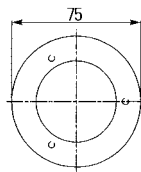

Part no.	Pk.	
2XT 959 500-677	1	Cockpit and map reading light with 4 white LEDs 1.0W
2XT 959 500-207	24	with 4 blue LEDs 1.0W

Orientation lights for flush mounting

In LED-technology. White lens.

With 4 white LEDs 1.0W, 120 mm long lead, gasket and fixing screws.
Consumption: 0.08A at 12V, 0.04A at 24V.
Type of protection: IP67.

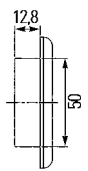
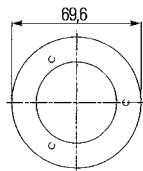

Part no.	Pk.	
2XT 980 500-227	24	Orientation light with polished stainless-steel frame, 12V
2XT 980 500-042	1	with white plastic frame, 12V
2XT 980 501-042	1	with white plastic frame, 24V

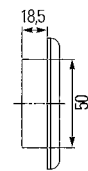
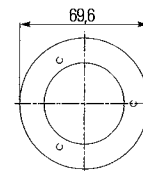

In LED-technology. White lens.

With 4 white HighPower LEDs 1.0W, 120 mm long lead, gasket and fixing screws.
Consumption: 0.08A at 12V, 0.04A at 24V.
Type of protection: IP67.



Part no.	Pk.	
2JA 959 599-002	1	Orientation light with white plastic frame, 12V
2JA 959 599-102	1	with white plastic frame, 24V

For flush mounting

In LED-technology. Clear lens.

Consumption: 0.04A at 12V, 0.02A at 24V.
With gasket, 2 fixing screws and screw caps,
dust and water-proof, with polarity reversal protection.
Voltage range: 10V - 33V.

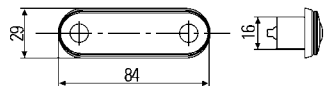

Part no.	Pk.	
2XT 959 510-427	36	Door light with 2 white LEDs 0.5W and 120 mm long lead
2XT 959 510-657	36	with 2 blue LEDs 0.5W and 120 mm long lead
2XT 959 510-467	24	with 2 white LEDs 0.5W, 150 mm long lead and 2-pole Packard plug

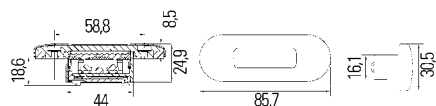

In LED-technology. Clear lens.

Consumption: 0.04A at 12V, 0.02A at 24V.
With polished steel rim, 120 mm lead, gasket and fixing screws.
Voltage range: 10V - 33V.
Type of protection: IP6K7K.

Part no.	Pk.	
2XT 959 680-812	36	Door light with 2 white LEDs 0.5W
2XT 959 680-612	36	with 2 blue LEDs 0.5W

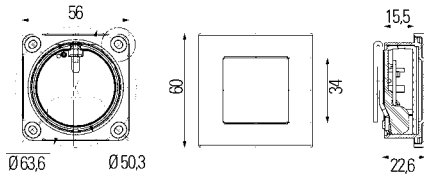

For flush mounting

In LED-technology. White lens.

Consumption: 0.08A at 12V, 0.04A at 24V.

With white plastic rim, 120 mm lead, gasket and fixing screws.

Type of protection: IP67.

Part no.	Pk.	
2XT 980 580-052	1	Door light with 4 white LEDs 12V1.0W
2XT 980 581-052	1	with 4 white LEDs 24V1.0W
2JA 980 596-002	1	with 4 white HighPower LEDs 12V1.0W
2JA 980 596-102	1	with 4 white HighPower LEDs 24V1.0W

With 2-pole AMP plug connector and bulb.

Snap fastening.

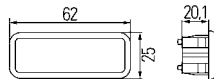

Part no.	Pk.	
2XT 009 098-007	250	Door light, 12V, with clear lens
2XT 009 098-107	250	with white lens
2XT 009 098-307	250	with red lens
8GP 003 594-141	10	Spare parts: W3W bulb, 12V
2XT 009 098-017	250	Door light, 24V, with clear lens
2XT 009 098-117	250	with white lens
2XT 009 098-317	250	with red lens
8GP 003 594-251	10	Spare parts: W5W bulb, 24V

Flush mounting for curves surfaces

Frosted white lens.

Black rubber body.

2 holes for B4.2 x 16 fixing screws.

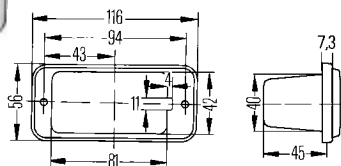

Part no.	Pk.	
2XT 002 452-037	1	Door light
8GA 002 071-121	10	Accessories: R5W bulb, 12V
8GA 002 071-241	10	24V

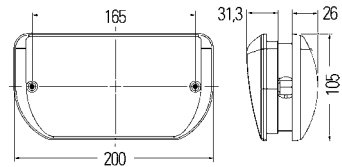
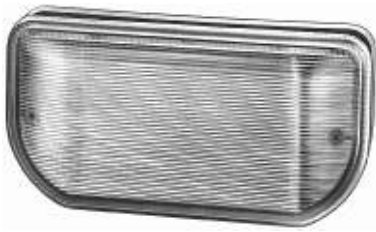

For caravans

Clear lens.
With grille opening for replacing bulb.
For walls of 25 to 35 mm thickness.
 Grey plastic body and glass-clear lens,
 for screwing into one another.

Part no.	Pk.	
2XT 007 945-027	1	Door light without ON/OFF switch, with 12V bulb and cable entry right
2XT 007 945-077	30	with two pole safety switch, 12V bulb and cable entry right
8GA 002 073-121	10	Spare parts for -027/-077: P21W bulb, 12V

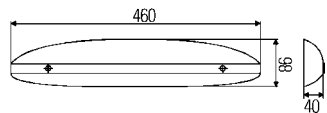

For horizontal surface mounting

In LED-technology. Clear lens. With 3 HighPower LEDs 4.5W and 200 mm long connecting lead with blade receptacles 6.3 mm.
Illuminance: 107 lux at a distance of 1 m.
 Consumption: 0.38A at 12V, 0.19A at 24V.
 Colour temperature 4000° Kelvin.
 Silver painted body.
 Two fixing screws ST3.9 x 38-C.

Part no.	Pk.	
2XT 008 929-011	1	Door light

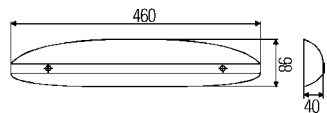

Clear lens. With 12V bulbs and gasket.
 Silver coloured body.
 Two ST3.9 x 38-C fixing screws.

Part no.	Pk.	
2XT 008 929-001	1	Door light
2XT 008 929-007	24	
8GM 002 092-121	10	Spare parts: C5W bulb, 12V

For flush mounting

For dashboards with thickness of 0.3 to 1.8 mm.
Screw-type connection.

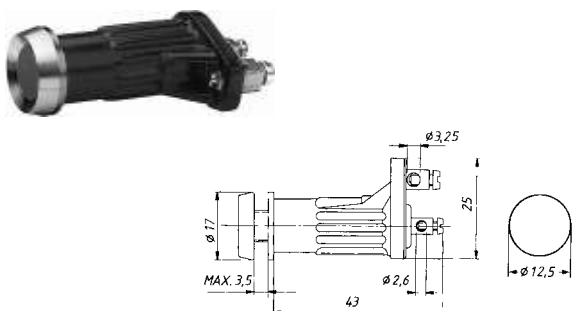
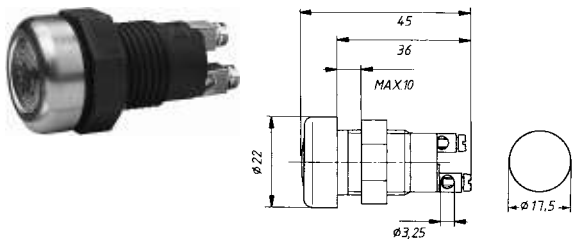
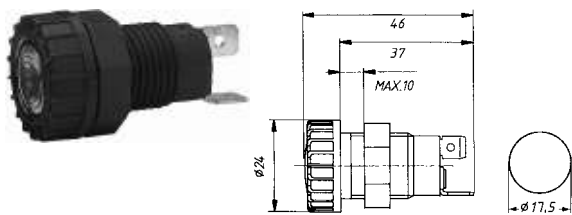
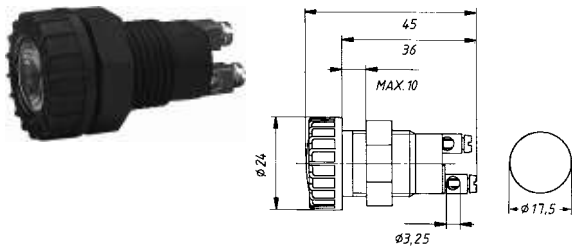

Part no.	Pk.	
		Warning light with screw-type connection, blue
2AA 008 592-001	15	
2AA 008 592-011	15	amber
2AA 008 592-021	15	green
2AA 008 592-031	15	red
		Spare parts:
8GP 002 068-121	10	H bulb, 12V
8GP 002 068-241	10	24V
		Warning light with blade terminal connections, blue
2AA 008 594-001	15	
2AA 008 594-011	15	amber
2AA 008 594-021	15	green
2AA 008 594-031	15	red
		Spare parts:
8GP 002 068-121	10	H bulb, 12V
8GP 002 068-241	10	24V
		Warning light with steel rim and screw-type connections, blue
2AA 008 595-001	15	
2AA 008 595-011	15	amber
2AA 008 595-021	15	green
2AA 008 595-031	15	red
		Spare parts:
8GP 002 068-121	10	H bulb, 12V
8GP 002 068-241	10	24V
		Warning light with screw-type connection, blue
2AA 008 593-001	15	
2AA 008 593-011	15	amber
2AA 008 593-021	15	green
2AA 008 593-031	15	red
		Spare parts:
8GP 002 066-121	10	J bulb, 12V
8GP 002 066-241	10	24V

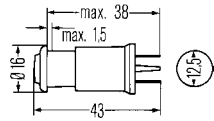

For flush mounting

For dashboards with thickness of 0.8 to 1.5 mm.
With blade terminal connections and clamp fixing.

Part no.	Pk.	
2AA 001 204-001	10	Warning light, red
2AA 001 204-011	10	amber
2AA 001 204-031	10	green
		Accessories:
8GP 002 066-121	10	J bulb, 12V
8GP 002 066-241	10	24V

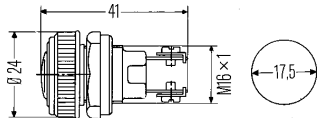

For dashboards with thickness of up to 4 mm.

Part no.	Pk.	
2AA 001 200-001	5	Warning light, with combined screw/blade terminal connections, blue
2AA 001 200-011	5	red
2AA 001 200-012	1	red, Pro-fit pack
2AA 001 200-021	5	green
2AA 001 200-023	1	green, Pro-fit pack
2AA 001 200-031	5	amber
		Warning light with blade terminal connections,
2AA 001 200-041	5	blue
2AA 001 200-131	5	red
2AA 001 200-141	5	green
2AA 001 200-151	5	amber
		Spare parts:
8GP 002 095-121	10	W5/1,2 bulb, 12V
8GP 002 095-241	10	24V



For dashboards with thickness of up to 1,5 mm. With blade terminal connections and clamp fixing.

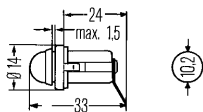

Part no.	Pk.	
2AA 001 201-011	10	Warning light, red
		Spare parts/Accessories:
9EL 043 137-001	10	Lens
8GP 002 066-121	10	J bulb, 12V
8GP 002 066-241	10	24V

For flush mounting

For dashboards with thickness of up to 5.2 mm.

With black cap, dust and waterproof, combined screw/blade terminal connections.

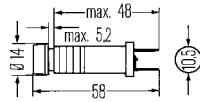

Part no.	Pk.	
2AA 003 257-001	1	Warning light, red
2AA 003 257-011	1	blue
2AA 003 257-021	1	green
2AA 003 257-031	1	amber
<hr/>		
2AA 003 257-041	1	Warning light with 4 lenses (red, blue, green, amber) included loose and 12V bulb. Carded
2AA 003 257-042	1	Pro-fit pack
Spare parts:		
8GP 002 066-121	10	J bulb, 12V
8GP 002 066-241	10	24V



Combined hazard warning flasher and work lights

3003

Amber lens for hazard flasher, white for work light.

With 6V bulb and black mounting bracket.

Flash frequency > 60 flashes per minute.

Operating time with new alkaline batteries:

Hazard flasher approx. 40 hours, work light approx. 25 hours.

The bulb and reflector pivot to the desired function when the switch above the lens is actuated.

The light exit angle on the work light can be varied by moving the feet to three different positions.

The light is stable up to a wind velocity of 9.

Orange-coloured plastic body, feet black plastic with rubber nubs.

5 x 1.5 mono cells (R20 or LR20) not included with light.

With built-in tester for battery capacity.

National type test for Germany.

Part no.	Pk.	
2XW 007 146-001	1	Hazard flasher light
Spare parts:		
8GP 002 096-061	10	F bulb, 6V

3003 Accu

Amber lens for hazard flasher, white for work light.

With 6V bulb and black mounting bracket.

Flash frequency > 60 flashes per minute.

Power supply: 6V, 3,0AH rechargeable battery.

Nominal voltage: 12V and 24V.

Power supply for charger circuit 10V to 32V.

Operating time with fully charged battery:

Hazard flasher approx. 40 hours, work light approx. 7 hours.

The bulb and reflector pivot to the desired function when the switch above the lens is actuated.

The light exit angle on the work light can be varied by moving the feet to three different positions.

The light is stable up to a wind velocity of 9.

Sulphur-yellow plastic body, feet black plastic with rubber nubs.

With maintenance-free, rechargeable lead gel battery and charging holder, for connecting to terminal 15 (ignition on) and terminal 31 (earth).

As soon as the light catches in the holder, the battery in the light starts being charged.

The charger operates with 12V and 24V systems.

Switch-over is automatic.

National type test for Germany.



Part no.	Pk.	
2XW 007 146-011	1	Hazard flasher light
Spare parts:		
8GP 002 096-061	10	F bulb, 6V

2002 Europa

Amber lens for hazard flasher, white for work light.

With 6V bulb and mounting bracket.

With folding supporting legs; rubber shoes ensure extreme stability (up to gale force 9).

For use with five U2-type, single-cell, leak proof, 1.5V batteries. Batteries are not supplied with light.

National type test for Germany.



Part no.	Pk.	
2XW 003 146-001	1	Hazard flasher light
Spare parts:		
8GP 002 096-061	10	F bulb, 6V

Hazard Flasher Lights

2897

Amber lens. With 6V bulb.

Black body, with folding supporting legs; rubber shoes ensure extreme stability (up to gale force 9).

For use with five U2-type, single-cell, leak proof, 1.5V batteries. Batteries are not supplied with light.

National type test for Germany.



Part no.	Pk.	
2XW 002 897-051	1	Hazard flasher light with plastic container
2XW 002 897-041	1	without plastic container
Spare parts/Accessories:		
8GP 002 096-061	10	F bulb, 6V
8XH 002 975-017	16	Plastic container

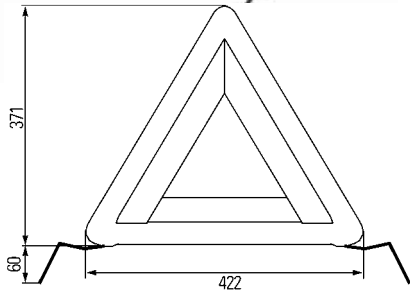

Emergency triangle

Precision-built, ultra-effective reflectors hit the eye both day and night.
 Sturdy four-point base keeps triangle in place.
 Very light weight.
 Folds compactly away into its box (428 x 89 x 24 mm) for space-saving storage.

Part no.	Pk.	
8RW 341 421-001	1	Emergency triangle

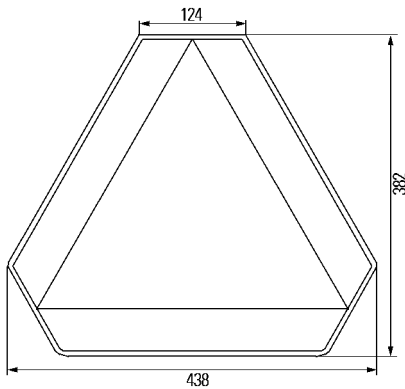

Emergency triangle for slow-moving vehicles

Precision-built, ultra-effective reflectors hit the eye both day and night.
 Very light in weight.
 Easy to store.
 Fastened with metal bracket and strip.

Part no.	Pk.	
8RW 341 235-007	20	Emergency triangle
Accessories:		
8HG 341 300-007	10	Strip
8HG 341 301-007	10	Bracket

Reflectors

Reflecting surface 22 sq. cm.

With plastic base plate.

One 6 mm dia. hole for fixing screw.

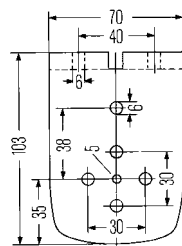
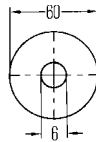

Part no.	Pk.		
8RA 002 014-031	25	Reflector, red	
8RA 002 014-032	80		
8RA 002 014-831	1		red, carded (2 pieces)
8RA 002 014-832	1		red, Pro-fit pack (2 pieces)
8RA 002 014-051	25	amber	
8RA 002 014-052	80		
8RA 002 014-851	1		amber, carded (2 pieces)
8RA 002 014-852	1		amber, Pro-fit pack (2 pieces)
8RA 002 014-041	25	white	
8RA 002 014-042	80		
8RA 002 014-842	1		white, Pro-fit pack (2 pieces)
8RA 002 014-127	100	with rubber holder 8HG 003 799-001, white	
Accessories:			
8HG 003 799-001	2	Rubber holder	
8HG 003 799-007	100		
8HG 003 799-017	1	Hard rubber holder	

Reflecting surface 22 sq. cm.

With plastic base plate, self-adhesive.

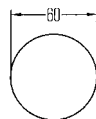

Part no.	Pk.	
8RA 002 014-081	25	Reflector, red
8RA 002 014-101	25	amber
8RA 002 014-091	25	white

Reflectors

Reflecting surface 20 sq. cm.

Metal base plate with central M5 x 15 fixing screw.

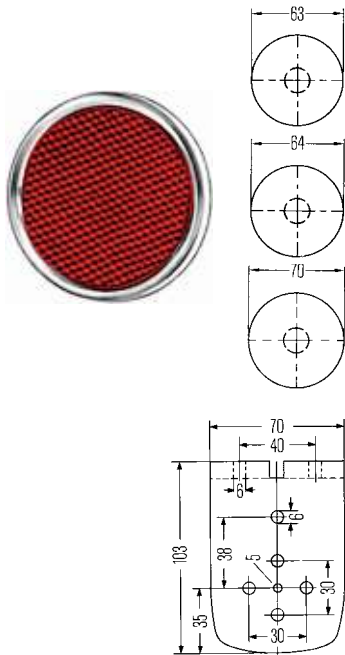

Part no.	Pk.	
8RA 002 015-001	20	Reflector, red
8RA 002 015-021	20	with aluminium rim, red
8RA 002 015-031	20	with rubber rim, red
8HG 003 799-001	2	Accessories: Rubber holder
8HG 003 799-007	100	
8HG 003 799-017	1	Hard rubber holder

Reflecting surface 38 sq. cm.

With central M5 x 15 fixing screw.

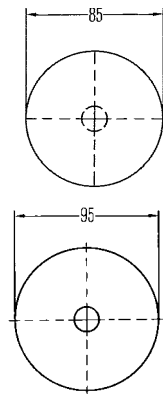

Part no.	Pk.	
8RA 002 016-111	32	Reflector with plastic base plate and rim, red
8RA 002 016-101	20	white
8RA 002 016-121	20	Reflector with PVC rim and base plate, red

Reflecting surface 18 sq. cm.

Self-adhesive, for horizontal or vertical mounting.

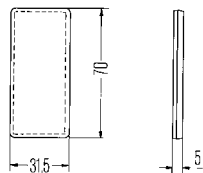

Part no.	Pk.	
8RA 004 412-021	20	Reflector, red
8RA 004 412-001	20	amber
8RA 004 412-011	20	white

Reflectors

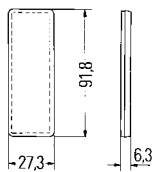

Reflecting surface 20.9 sq. cm.

Self-adhesive, for horizontal or vertical mounting.

Part no.	Pk.	
8RA 342 014-157	100	Reflector, red

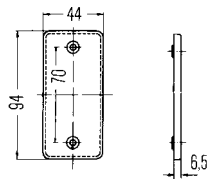

Reflecting surface 29 sq. cm.

With plastic base plate.

Self-adhesive, for horizontal or vertical mounting.

Part no.	Pk.	
8RA 003 326-001	20	Reflector with two 4.3 m dia. holes for fixing screws, red
8RA 003 326-002	200	
8RA 003 326-011	20	amber
8RA 003 326-017	200	
8RA 003 326-021	20	white
8RA 003 326-031	20	Reflector self-adhesive, red
8RA 003 326-931	1	
8RA 003 326-041	20	amber
8RA 003 326-047	200	
8RA 003 326-051	20	white

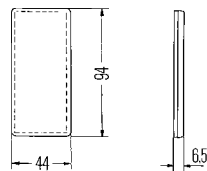

Reflecting surface 50 sq. cm.

With plastic base plate.

Self-adhesive, for horizontal or vertical mounting.

Part no.	Pk.	
8RB 004 713-001	20	Reflector, amber

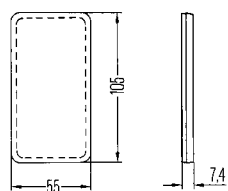

Reflectors

Reflecting surface 47 sq. cm.
With plastic base plate.

Two 6 mm dia. holes for fixing screws.
For horizontal or vertical mounting.

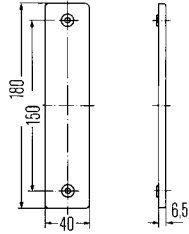

Part no.	Pk.	Reflector,
8RA 002 023-001	20	red
8RA 002 023-021	20	amber
8RA 002 023-011	20	white

Reflecting surface 60 sq. cm.
With plastic base plate.

Two 6.5 mm dia. holes for fixing screws.
For horizontal or vertical mounting.

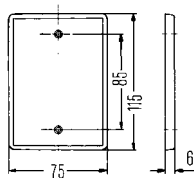
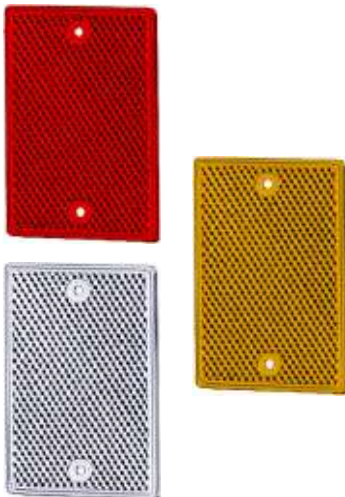

Part no.	Pk.	Reflector,
8RL 002 009-021	20	red
8RL 002 009-011	20	amber
8RL 002 009-001	20	white

Reflecting surface 101 sq. cm.
With plastic base plate.

Two M6 x 12 fixing screws.
For horizontal or vertical mounting.

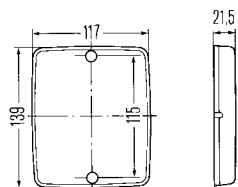

Part no.	Pk.	Reflector,
8RA 003 660-007	8	red

Reflectors

Reflecting surface 54 sq. cm.
 With rubber base plate.
 Two B3.9 x 22 fixing screws.
 For horizontal or vertical mounting.

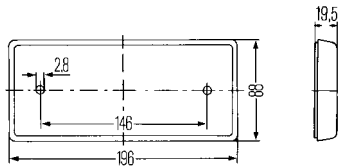

Part no.	Pk.	
8RA 003 734-101	1	Reflector, red

Reflecting surface 95 sq. cm.
 Reflector thickness 8.2 mm.

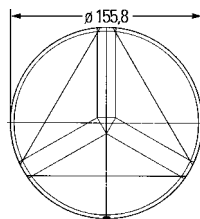
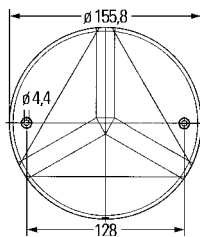

Part no.	Pk.	
8RA 343 220-017	30	Triangular reflector, red, with holes for fixing screws
8RA 343 220-007	30	self-adhesive

Reflecting surface 85 sq. cm.

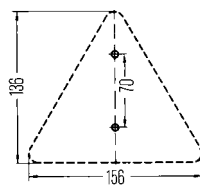

Part no.	Pk.	
8RA 002 020-001	25	Triangular reflector with plastic base plate and two 6 mm dia. holes for fixing screws, red
8RA 002 020-002	120	
8RA 002 020-003	1	red, carded
8RA 002 020-051	10	Triangular reflector with plastic base plate and additional metal base plate, two M5 x 20 fixing screws, red
8RA 002 020-031	10	Triangular reflector with plastic base plate and sendzimir galvanized mounting bracket for compensating inclination, two 3.7 mm dia. holes for fixing screws, red

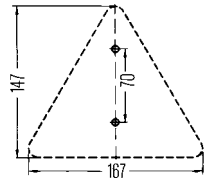

Reflectors

Reflecting surface 101 sq. cm.
With protective rubber rim.
Two M6 x 15 fixing screws.

Part no.	Pk.	
8RA 002 010-011	20	Reflector, red

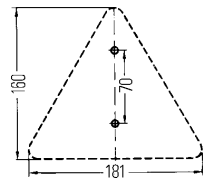

Reflecting surface 57 sq. cm.
Two M5 fixing screws.

Part no.	Pk.	
8RA 003 503-001	16	Triangular reflector, quadrifid, red



Flexible supports for reflectors

PVC-covered steel strip.
Two M5 x 20 fixing screws.
Distance between screws: 25 up to 36 mm.
Three 6.3 mm dia. holes.
Distance between holes for fixing reflectors 50 x 70 mm.

Part no.	Pk.	
8HG 002 240-001	10	Support for reflector, length 200 mm, width 51 mm
8HG 002 240-011	10	length 250 mm, width 51 mm
8HG 002 240-021	10	length 300 mm, width 51 mm
8HG 002 240-031	10	length 400 mm, width 51 mm



Codes	6.02-6.03
Rotating beacons, flashing beacons, warning lights	
Rotating beacons	6.04-6.13
Flashing beacons	6.14-6.20, 6.26-6.28
Accessories for rotating- and flashing beacons	6.21-6.22
Spare parts for old-type rotating- and flashing beacons	6.23-6.25
Accessories for old-type rotating- and flashing beacons	6.23-6.25
Warning lights	6.29-6.30
Optical warning systems	
Raptor: Product descriptions and accessories	6.31-6.32
OWS 7: Product descriptions and spare parts	6.33-6.37
OWS-QS: Accessories and spare parts	6.38-6.39
OWS 540 up to 1600: Product descriptions, accessories and spare parts	6.40-6.45
OWS 4: Spare parts for old-type systems	6.46
Rotating-/flashing beacon and siren combinations	
RTK 7: Product descriptions and spare parts	6.47-6.49
RTK-QS: Accessories and spare parts	6.50-6.53
RTK-VE 7: Product descriptions and accessories	6.54-6.55
RTK-VE: Product descriptions and accessories	6.56-6.59

Code	Explanation
AAS	Acoustic stop signal
AIRHORN	Electric horn
AL	Stop light
ALL	Alley Light (close-range illumination) left
ALR	Alley Light (close-range illumination) right
ASG-LED-Matrix	Stop signal in Matrix-technology (programmable)
ASW	Work light
AZD	Push-pull-rotary alarm switch (mechanical operating concept)
BSF-LED	Driving strobe light
BSN-LED	Close-range strobe headlight
BSX	Strobe beacons
C-LED	Corner light
CANopenCiA 447	HighSpeed-CAN for RTK-modules to CiA447
DIN	DIN 14610 tone sequence
eAZD	Electronic control unit
EMV	Electromagnetic compatibility
eNF	Electronic operating concept for the control of communication functions in special signal systems
FL	Rotating beacon with tubular fitting for support
HDK	Horn pushbutton/horn
HILO	High-low two-tone sequence 1
HILO2	High-low two-tone sequence 2
HKL	Main rotating beacon
HWL	Warning light
HWL-LED	Warning light in LED-technology
HWL-X	Warning light in xenon-technology
KL	Rotating beacon
KL-A	Tripod for fitting a high-mounted beacon
KLF	Tone sequence
KLFB	Tone sequence standby
K-LED	LED beacon
KL-ER	Beacon with single reflector system (for roof bar systems)
KL-MR	Beacon with multiple reflector system (for roof bar systems)
KL-LM2	Beacon with LED 2-level module system
KL-LR 2	Beacon with LED trough module system (for roof bar systems)
KLX	Strobe beacon
KL-XL	Beacon with xenon-double flashing system
KL-XL2	Beacon with xenon-double flashing system
KL-XR	Beacon with xenon-parabolic trough reflector system
KL-XR2	Beacon with xenon-parabolic trough reflector system
KSK	Cross signal button
LSB	LED Signal Bar, chaser light
LSP	Loudspeaker
LSP-H	Loudspeaker, rear
LSP-V	Loudspeaker, front

Codes	Explanation
M	Beacon attachment variant with magnetic attachment
MAN	Manual siren
OWS	Optical warning system
OWS 4	Optical warning system (old-type)
OWS-MR	Optical warning system with multiple reflector system
OWS-X	Optical warning system with xenon system
PC	Polycarbonate
R	Rotating beacon with tubular fitting for support
RTK	Rotating beacon and siren combinations
RTK-VE	Sound warning system
SB	Rotating beacon with single bolt for fitting
SOR	Sound Order Readiness
Teledux 9	non-standardised two-way radio
WAIL	Slow siren
WL-LED	Warning light in LED-technology
YELP	Fast siren
ZSE	Control unit light
ZSE L	Control unit light
ZSE L/A	Control unit light and acoustic
ZSE-VE	Control unit

Rotating beacons with halogen H1 light

KL Rotaflex FL

According to DIN 14 620, shape A, n = 160 U/min.
 With built-in bulb. Light aperture (reflector dia.): 76.5 mm.
 Black rubber housing with tubular fitting for support,
 max. inclination 90°.
 Total power consumption: 12V55W = 5.5A, 24V70W = 3.5A.
 Operating temperature: -40 °C to +60 °C.
 RF suppression: CISPR 25, class 5 (conducted).
 Resistant to high pressure cleaning.

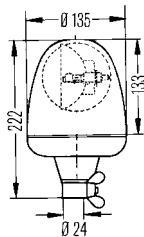

Part no.	Pk.	
2RL 006 846-101	1	Rotating beacon, blue, 12V
2RL 006 846-111	1	Rotating beacon, blue, 24V
2RL 006 846-001	1	Rotating beacon, amber, 12V
2RL 006 846-011	1	Rotating beacon, amber, 24V
Spare parts:		
Dome,		
9EL 859 020-101	1	blue
9EL 859 020-001	1	amber (Polycarbonat)
9GP 859 115-001	1	Rubber housing
Motor,		
9MN 858 114-001	1	12V
9MN 858 114-011	1	24V
9DX 860 438-001	1	Reflector
H1 bulb,		
8GH 002 089-133	1	12V55W
8GH 002 089-251	1	24V70W

KL Rotafix F

According to DIN 14 620 form B1., n = 160 U/min.
 With built-in bulb. Light aperture (reflector dia.): 76.5 mm.
 With black base for permanent mounting on level surface.
 Total power consumption: 12V55W = 5.5A, 24V70W = 3.5A.
 Operating temperature: -40 °C to +60 °C.
 RF suppression: CISPR 25, class 5 (conducted).
 Resistant to high pressure cleaning.

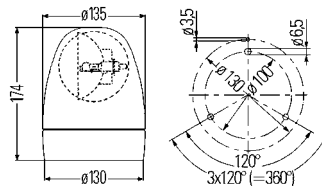

Part no.	Pk.	
2RL 007 337-101	1	Rotating beacon, blue, 12V
2RL 007 337-111	1	Rotating beacon, blue, 24V
2RL 007 337-001	1	Rotating beacon, amber, 12V
2RL 007 337-011	1	Rotating beacon, amber, 24V
2RL 007 337-041	1	Rotating beacon, with 24V bulb and belt drive, amber, 12V/24V
Spare parts:		
Dome,		
9EL 859 020-101	1	blue
9EL 859 020-001	1	amber (Polycarbonat)
Motor,		
9MN 858 114-001	1	12V
9MN 858 114-011	1	24V
9MN 862 741-001	1	12V/24V for -041
9XR 854 840-001	1	Drive belts (2 pieces) for -041
Reflector		
9DX 860 271-001	1	for 2RL 007 337-... (except -041)
9DX 862 844-001	1	for 2RL 007 337-041
H1 bulb,		
8GH 002 089-133	1	12V55W
8GH 002 089-251	1	24V70W

Rotating beacons with halogen H1 light

KL Rotafix M

According to DIN 14 620 form B1., n = 160 U/min.

With built-in bulb. Light aperture (reflector dia.): 76.5 mm.

Black base with magnetic attachment, spirally-coiled lead extends up to 2.5 m and 2-pole plug for connecting to the cigarette lighter socket.

Total power consumption: 12V55W = 5.5A, 24V70W = 3.5A.

Operating temperature: -40 °C to +60 °C.

RF suppression: CISPR 25, class 5 (conducted).

Resistant to high pressure cleaning.

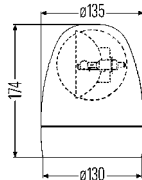

Part no.	Pk.	
2RL 007 337-121	1	Rotating beacon, blue, 12V
2RL 007 337-021	1	amber, 12V
2RL 007 337-031	1	amber, 24V
2RL 007 337-057	1	with spirit level, amber, 24V
Spare parts:		
Dome,		
9EL 859 020-101	1	blue
9EL 859 020-001	1	amber (Polycarbonat)
Motor,		
9MN 858 114-001	1	12V
9MN 858 114-011	1	24V
9DX 860 271-001	1	Reflector
H1 bulb,		
8GH 002 089-133	1	12V55W
8GH 002 089-251	1	24V70W

KL JuniorPlus F

According to DIN 14 620, shape B1, n = 180 U/min.

Light aperture (reflector dia.): 95 mm.

Base for permanent mounting.

Total power consumption: 12V55W = 5A, 24V70W = 3A.

Operating temperature: -40 °C to +60 °C.

RF suppression: CISPR 25, class 3 (conducted).

Resistant to high pressure cleaning.

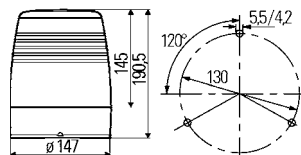

Part no.	Pk.	
2RL 008 965-031	1	Rotating beacon with bulb, blue, 12V
2RL 008 965-041	1	with bulb, blue, 24V
2RL 008 965-001	1	with bulb, amber, 12V
2RL 008 965-011	1	with bulb, amber, 24V
2RL 008 965-021	1	without bulb, amber, 12/24V
Spare parts:		
Dome,		
blue		
9EL 863 100-041	1	blue
9EL 863 100-001	1	amber
9MN 863 026-001	1	Motor, 12V/24V
9XR 855 975-001	1	Drive belts (2 pieces)
H1 bulb,		
8GH 002 089-133	1	12V55W
8GH 002 089-251	1	24V70W

Rotating beacons with halogen H1 light

KL JuniorPlus M

According to DIN 14 620, shape B1., n = 180 U/min.

Light aperture (reflector dia.): 95 mm.

With magnetic attachment, spirally-coiled lead extends up to 3.5 m and 2-pole plug for connecting to the cigarette lighter socket.

Total power consumption: 12V55W = 5A, 24V70W = 3A.

Operating temperature: -40 °C to +60 °C.

RF suppression: CISPR 25, class 3 (conducted).

Resistant to high pressure cleaning.

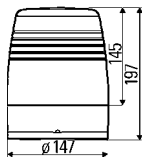

Part no.	Pk.	
2RL 008 966-031	1	Rotating beacon with bulb, blue, 12V
2RL 008 966-001	1	with bulb, amber, 12V
2RL 008 966-021	1	without bulb, amber, 12/24V
Spare parts:		
Dome,		
9EL 863 100-041	1	blue
9EL 863 100-001	1	amber
9MN 863 026-001	1	Motor, 12V/24V
9XR 855 975-001	1	Drive belts (2 pieces)
H1 bulb,		
8GH 002 089-133	1	12V55W
8GH 002 089-251	1	24V70W

KL JuniorPlus FL

According to DIN 14 620 Form A, n = 180 U/min.

Light aperture (reflector dia.): 95 mm.

Base plate with flexible tubular fitting for support tube.

Max. inclination 90°.

Total power consumption: 12V55W = 5A, 24V70W = 3A.

Operating temperature: -40 °C to +60 °C.

RF suppression: CISPR 25, class 3 (conducted).

Resistant to high pressure cleaning.

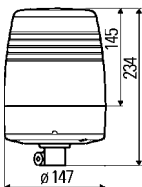

Part no.	Pk.	
2RL 008 967-031	1	Rotating beacon with bulb, blue, 12V
2RL 008 967-041	1	with bulb, blue, 24V
2RL 008 967-001	1	with bulb, amber, 12V
2RL 008 967-011	1	with bulb, amber, 24V
2RL 008 967-021	1	without bulb, amber, 12/24V
Spare parts:		
Dome,		
9EL 863 100-041	1	blue
9EL 863 100-001	1	amber
9NM 863 332-001	1	Wing nut mount (Junior Plus FL)
9MN 863 026-001	1	Motor, 12V/24V
9XR 855 975-001	1	Drive belts (2 pieces)
H1 bulb,		
8GH 002 089-133	1	12V55W
8GH 002 089-251	1	24V70W

Rotating beacons with halogen H1 light

KL JuniorPlus SB

According to DIN 14 620 Form A, n = 180 U/min.

Light aperture (reflector dia.): 95 mm.

Base plate with single bolt for fitting.

Total power consumption: 2V55W = 5A, 24V70W = 3A.

Operating temperature: -40 °C to +60 °C.

RF suppression: CISPR 25, class 3 (conducted).

Resistant to high pressure cleaning.

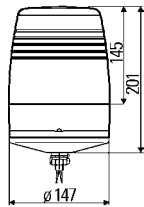

Part no.	Pk.	
		Rotating beacon
2RL 008 990-001	1	with bulb, amber, 12V
2RL 008 990-011	1	with bulb, amber, 24V
2RL 008 990-021	1	without bulb, amber, 12/24V
		Spare parts:
		Dome,
9EL 863 100-041	1	blue
9EL 863 100-001	1	amber
9MN 863 026-001	1	Motor, 12V/24V
9XR 855 975-001	1	Drive belts (2 pieces)
		H1 bulb,
8GH 002 089-133	1	12V55W
8GH 002 089-251	1	24V70W

KL Junior F

According to DIN 14 620, shape B1, n = 160 U/min.

Light aperture (reflector dia.): 103 mm.

Amber base for permanent mounting.

Total power consumption: 12V55W = 5,5A, 24V70W = 3,5A.

Operating temperature: -20 °C bis +60 °C.

RF suppression: CISPR 25, class 3 (conducted).

Resistant to high pressure cleaning.

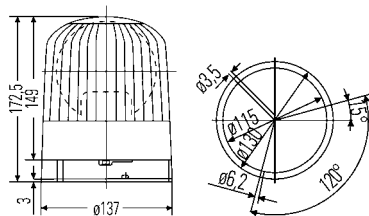

Part no.	Pk.	
		Rotating beacon
2RL 007 550-001	1	with bulb, amber, 12V
2RL 007 550-011	1	with bulb, amber, 24V
2RL 007 550-021	1	without bulb, amber, 12/24V
		Spare parts/Accessories:
		Dome,
9EL 860 627-001	1	amber
9EL 860 628-021	1	blue
		Motor,
9MN 860 677-001	1	12V
9MN 860 677-011	1	24V
9MN 860 677-021	1	12V/24V
		H1 bulb,
8GH 002 089-133	1	12V55W
8GH 002 089-251	1	24V70W

Rotating beacons with halogen H1 light

KL Junior M

According to DIN 14 620, shape B1, n = 160 U/min.

Light aperture (reflector dia.): 103 mm.

Amber base with magnetic attachment, spirally-coiled lead extends up to 3.5 m and 2-pole plug for connecting to the cigarette lighter socket.

Total power consumption: 12V55W = 5.5A, 24V70W = 3.5A.

Operating temperature: -20 °C to +60 °C.

RF suppression: CISPR 25, class 3 (conducted).

Resistant to high pressure cleaning.

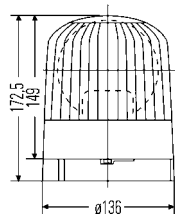

Part no.	Pk.	
2RL 007 552-001	1	Rotating beacon with bulb, amber, 12V
2RL 007 552-011	1	with bulb, amber, 24V
2RL 007 552-021	1	without bulb, amber, 12/24V
Spare parts/Accessories:		
9EL 860 627-001	1	Dome, amber
9EL 860 628-021	1	blue
Motor,		
9MN 860 677-001	1	12V
9MN 860 677-011	1	24V
9MN 860 677-021	1	12V/24V
H1 bulb,		
8GH 002 089-133	1	12V55W
8GH 002 089-251	1	24V70W

KL Junior R

According to DIN 14 620 shape A, n = 160 U/min.

Light aperture (reflector dia.): 103 mm.

Amber base with flexible tubular fitting for support tube.

Total power consumption: 12V55W = 5.5A, 24V70W = 3.5A.

Operating temperature: -20 °C to +60 °C.

RF suppression: CISPR 25, class 3 (conducted).

Resistant to high pressure cleaning.

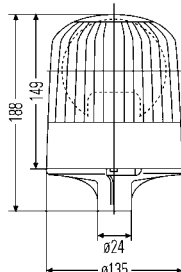

Part no.	Pk.	
2RL 007 551-001	1	Rotating beacon with bulb, amber, 12V
2RL 007 551-011	1	with bulb, amber, 24V
2RL 007 551-021	1	without bulb, amber, 12/24V
Spare parts/Accessories:		
Dome,		
9EL 860 627-001	1	amber
9EL 860 628-021	1	blue
Motor,		
9MN 860 677-001	1	12V
9MN 860 677-011	1	24V
9MN 860 677-021	1	12V/24V
H1 bulb,		
8GH 002 089-133	1	12V55W
8GH 002 089-251	1	24V70W

Rotating beacons with halogen H1 light

KL Junior FL

According to DIN 14 620 shape A, n = 160 U/min.
 With PC light dome. Light aperture (reflector dia.): 103 mm.
 Base with flexible tubular fitting for support tube,
 max. inclination 90°.
 Total power consumption: 12V55W = 5.5A, 24V70W = 3.5A.
 Operating temperature: -20 °C to +60 °C.
 RF suppression: CISPR 25, class 3 (conducted).
 Resistant to high pressure cleaning.

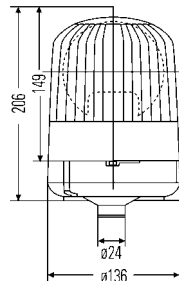

Part no.	Pk.	
2RL 007 553-001	1	Rotating beacon with bulb, amber, 12V
2RL 007 553-011	1	with bulb, amber, 24V
2RL 007 553-021	1	without bulb, amber, 12/24V
Spare parts/Accessories:		
9EL 860 627-011	1	Dome, amber (Polycarbonat)
9EL 860 628-021	1	blue
9MN 860 677-001	1	Motor, 12V
9MN 860 677-011	1	24V
9MN 860 677-021	1	12V/24V
8GH 002 089-133	1	H1 bulb, 12V55W
8GH 002 089-251	1	24V70W

KL 5000 M

According to DIN 14 620, shape B1, n = 160 U/min.
 With built-in 12V bulb. Light aperture (reflector dia.): 76 mm.
 Black base.
 With magnetic attachment, spirally-coiled lead extends up to 2.5 m and 2-pole plug for connecting to the cigarette lighter socket or boardsocket to DIN-ISO 4165.
 Total power consumption: 12V55W = 4.5A.
 Operating temperature: -40 °C to +60 °C.
 RF suppression: CISPR 25, class 5 (conducted).
 Resistant to high pressure cleaning.

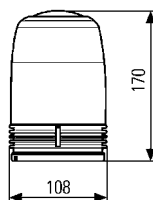

Part no.	Pk.	
2RL 008 364-021	1	Rotating beacon, blue, 12V
Spare parts/Accessories:		
9EL 862 267-031	1	Dome
9XR 854 840-001	1	Drive belts (2 pieces)
8JB 004 777-002	1	Boardsocket, 2-pole
8JB 004 777-001	5	
8GH 002 089-133	1	H1-bulb, 12V55W

Rotating beacons with halogen H1 light

KL 7000 F

According to DIN 14 620, shape B1, n = 160 U/min.
 With built-in bulb. Light aperture (reflector dia.): 84 mm.
 Base with three-point mounting and rubber gasket for permanent mounting.
 Total power consumption: 12V55W = 5.5A, 24V70W = 3.5A.
 Operating temperature: -40 °C to +60 °C.
 RF suppression: CISPR 25, class 5 (conducted).
 Resistant to high pressure cleaning.

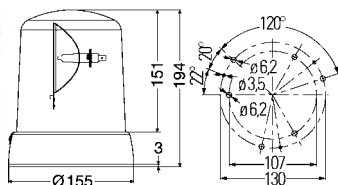

Part no.	Pk.	
2RL 008 061-001	1	Rotating beacon, blue, 12V
2RL 008 061-011	1	blue, 24V
2RL 008 061-101	1	amber, 12V
2RL 008 061-111	1	amber, 24V
Spare parts:		
9EL 862 140-001	1	Dome, blue
9EL 862 141-001	1	amber
9EL 862 141-021	1	amber (Polycarbonat)
9MN 862 741-001	1	Motor 12V/24V
9XR 854 840-001	1	Drive belts (2 pieces)
9DX 862 740-001	1	Reflector
9GD 862 164-001	1	Rubber gasket
8GH 002 089-133	1	H1 bulb, 12V55W
8GH 002 089-251	1	24V70W

KL 7000 M

According to DIN 14 620, shape B1, n = 160 U/min.
 With built-in bulb. Light aperture (reflector dia.): 84 mm.
 Base with magnetic attachment, spirally-coiled lead extends up to 2.5 m and 2-pole plug for connecting to the cigarette lighter socket.
 Total power consumption: 12V55W = 5.5A, 24V70W = 3.5A.
 Operating temperature: -40 °C to +60 °C.
 RF suppression: CISPR 25, class 5 (conducted).
 Resistant to high pressure cleaning.

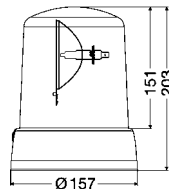

Part no.	Pk.	
2RL 008 062-001	1	Rotating beacon, blue, 12V
2RL 008 062-011	1	blue, 24V
2RL 008 062-101	1	amber, 12V
2RL 008 062-111	1	amber, 24V
Spare parts:		
9EL 862 140-001	1	Dome, blue
9EL 862 141-001	1	amber
9EL 862 141-021	1	amber (Polycarbonat)
9MN 862 741-001	1	Motor 12V/24V
9XR 854 840-001	1	Drive belts (2 pieces)
9DX 862 740-001	1	Reflector
8GH 002 089-133	1	H1 bulb, 12V55W
8GH 002 089-251	1	24V70W

Rotating beacons with halogen H1 light

KL 7000 FL

According to DIN 14 620 shape A, n = 160 U/min.

With bulb. Light aperture (reflector dia.): 84 mm.

Base with flexible tubular fitting for support tube. Max. inclination 90°.

Total power consumption: 12V55W = 5.5A, 24V70W = 3.5A.

Operating temperature: -40 °C to +60 °C.

RF suppression: CISPR 25, class 5 (conducted).

Resistant to high pressure cleaning.

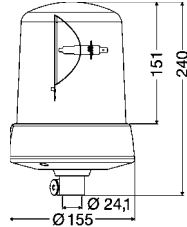

Part no.	Pk.	
2RL 008 063-001	1	Rotating beacon, blue, 12V
2RL 008 063-011	1	blue, 24V
2RL 008 063-101	1	amber, 12V
2RL 008 063-111	1	amber, 24V
Spare parts:		
Dome,		
9EL 862 140-001	1	blue
9EL 862 141-001	1	amber
9EL 862 141-021	1	amber (Polycarbonat)
9MN 862 741-001	1	Motor 12V/24V
9XR 854 840-001	1	Drive belts (2 pieces)
9DX 862 740-001	1	Reflector
9NM 863 332-001	5	Wing nut mount
H1 bulb,		
8GH 002 089-133	1	12V55W
8GH 002 089-251	1	24V70W

KL 7000 R

According to DIN 14 620 shape A, n = 160 U/min.

With bulb. Light aperture (reflector dia.): 84 mm.

Base with tubular fitting for support tube.

Total power consumption: 12V55W = 5.5A, 24V70W = 3.5A.

Operating temperature: -40 °C to +60 °C.

RF suppression: CISPR 25, class 5 (conducted).

Resistant to high pressure cleaning.

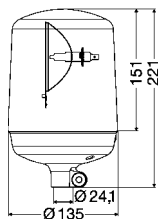

Part no.	Pk.	
2RL 008 060-001	1	Rotating beacon, blue, 12V
2RL 008 060-011	1	blue, 24V
2RL 008 060-101	1	amber, 12V
2RL 008 060-111	1	amber, 24V
Spare parts:		
Dome,		
9EL 862 140-001	1	blue
9EL 862 141-001	1	amber
9EL 862 141-021	1	amber (Polycarbonat)
9MN 862 741-001	1	Motor 12V/24V
9XR 854 840-001	1	Drive belts (2 pieces)
9DX 862 740-001	1	Reflector
9NM 863 332-001	5	Wing nut mount
H1 bulb,		
8GH 002 089-133	1	12V55W
8GH 002 089-251	1	24V70W

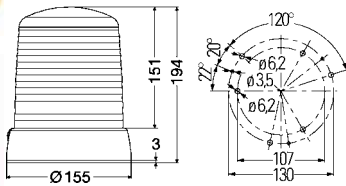

Rotating beacons 230V

KL 7000 230V

According to DIN 14 620, shape B1, $n = 160$ U/min.

With rubber gasket and 230V25W.

Light aperture (reflector dia.): 84 mm.

With base for mounting on emergency call box, fire-alarm box etc.

With three-point mounting.

Total power consumption: 230V with 25W bulb = 0.2A.

Operating temperature: -30 °C to $+60$ °C.

Resistant to high pressure cleaning.

Part no.	Pk.	
2RL 008 064-101	1	Rotating beacon with amber base, amber, 230V
2RL 008 064-001	1	with black base, red, 230V
Spare parts:		
9EL 862 141-001	1	Dome with optical pattern, amber
9EL 862 141-021	1	amber (Polycarbonat)
9EL 862 141-011	1	red
9MN 854 290-001	1	Motor with gear unit, 240V
9GD 862 164-001	1	Rubber gasket
8GS 002 383-001	1	C2 bulb, 230V25W

Rotating beacons with halogen H1 light

KL 8000 F

According to DIN 14 620, shape B2, n = 160 U/min.

With rubber gasket and bulb.

Light aperture (reflector dia.): 111.6 mm.

With base for permanent mounting. Two holes for M6 fixing screws or B4,2 tapping screws.

Total power consumption: 12V55W = 5,5A, 24V70W = 3,5A.

Operating temperature: -40 °C bis +60 °C.

Resistant to high pressure cleaning.

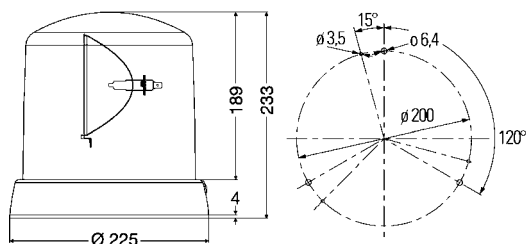

Part no.	Pk.	
2RL 008 065-001	1	Rotating beacon with black base, blue, 12V
2RL 008 065-011	1	blue, 24V
2RL 008 065-101	1	Rotating beacon with amber base, amber, 12V
2RL 008 065-107	48	
2RL 008 065-111	1	amber, 24V
Spare parts:		
Dome,		
9EL 862 171-001	1	blue
9EL 862 172-001	1	amber
9MN 862 741-001	1	Motor 12V/24V
9XR 854 840-001	1	Drive belts (2 pieces)
9DX 862 742-001	1	Reflector
9GD 862 178-001	1	Rubber spacer, flat
8GH 002 089-133	1	H1 bulb, 12V55W
8GH 002 089-251	1	24V70W
Accessories:		
Rubber bases, flat		
9GD 862 178-001	1	
9GD 862 734-001	1	high
9GD 859 037-011	1	wedge-shaped

Electronic flashing beacons

KLX Junior Plus F

According to DIN 14 620, shape B1.
 For permanent mounting. PC dome.
 With built-in xenon tube (gas discharge bulb with plug-in base).
 Light aperture: 95 mm dia.

Total power consumption: 12V = 3,3A, 24V = 1,7A.
 Electrical strobe power: 10 + 2 Ws.
 Strobe frequency: 2 Hz = double flashes.
 Operating temperature: -40 °C to +60 °C.
 RF suppression: CISPR 25, class 3 (conducted).
 Resistant to high pressure cleaning.

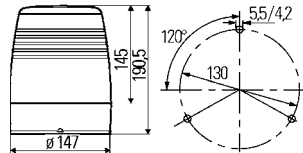

Part no.	Pk.	
2XD 009 051-021	1	Flashing beacon, blue, 12V
2XD 009 051-031	1	blue, 24V
2XD 009 051-001	1	amber, 12V
2XD 009 051-011	1	amber, 24V
Spare parts:		
9EL 863 100-051	1	PC-dome, blue
9EL 863 100-031	1	amber
9EL 862 678-001	1	Ring lens with Fresnel optics
8GS 863 261-001	1	Xenon tube

KLX Junior Plus M

According to DIN 14 620, shape B1.
 With magnetic attachment, spirally-coiled lead extends up to 3.5 m and 2-pole plug for connecting to cigarette lighter socket. PC dome.
 With built-in xenon tube (gas discharge bulb with plug-in base).
 Light aperture: 95 mm dia.

Total power consumption: 12V = 3,3A, 24V = 1,7A.
 Electrical strobe power: 10 + 2 Ws.
 Strobe frequency: 2 Hz = double flashes.
 Operating temperature: -40 °C to +60 °C.
 RF suppression: CISPR 25, class 3 (conducted).
 Resistant to high pressure cleaning.

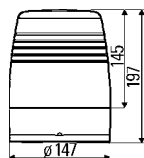

Part no.	Pk.	
2XD 009 053-021	1	Flashing beacon, blue, 12V
2XD 009 053-001	1	amber, 12V
Spare parts:		
9EL 863 100-051	1	PC-dome, blue
9EL 863 100-031	1	amber
9EL 862 678-001	1	Ring lens with Fresnel optics
8GS 863 261-001	1	Xenon tube

Electronic flashing beacons

KLX Junior Plus FL

According to DIN 14 620, shape A.
 With flexible tubular fitting for support tube, max. inclination 90°. PC dome.
 With built-in xenon tube (gas discharge bulb with plug-in base).
Light aperture: 95 mm dia.
 Total power consumption: 12V = 3,3A, 24V = 1,7A.
 Electrical strobe power: 10 + 2 Ws.
 Strobe frequency: 2 Hz = double flashes.
 Operating temperature: -40 °C to +60 °C.
 RF suppression: CISPR 25, class 3 (conducted).
 Resistant to high pressure cleaning.

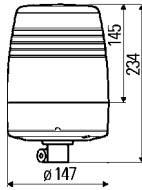

Part no.	Pk.	
2XD 009 052-021	1	Flashing beacon, blue, 12V
2XD 009 052-031	1	blue, 24V
2XD 009 052-001	1	amber, 12V
2XD 009 052-011	1	amber, 24V
Spare parts:		
9EL 863 100-051	1	PC-dome, blue
9EL 863 100-031	1	amber
9EL 862 678-001	1	Ring lens with Fresnel optics
8GS 863 261-001	1	Xenon tube
9NM 863 332-001	1	Wing nut mount

KLX Junior Plus SB

According to DIN 14 620, shape A.
 Single bolt for fitting. PC dome.
 With built-in xenon tube (gas discharge bulb with plug-in base).
Light aperture: 95 mm dia.
 Total power consumption: 12V = 3,3A, 24V = 1,7A.
 Electrical strobe power: 10 + 2 Ws.
 Strobe frequency: 2 Hz = double flashes.
 Operating temperature: -40 °C to +60 °C.
 RF suppression: CISPR 25, class 3 (conducted).
 Resistant to high pressure cleaning.

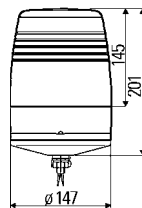

Part no.	Pk.	
2XD 009 054-001	1	Flashing beacon, amber, 12V
Spare parts/Accessories:		
9EL 863 100-031	1	PC-dome, amber
9EL 863 100-051	1	blue
9EL 862 678-001	1	Ring lens with Fresnel optics
8GS 863 261-001	1	Xenon tube

Electronic flashing beacons

KLX 5000 M

With magnetic attachment, integrated power supply and built-in xenon tube (gas discharge bulb).

Light aperture: 80 mm dia.

Shielding basket over xenon bulb reduces high-frequency interference radiation and ensures good radio reception.

Power consumption: 3A. Electrical strobe power: 10 + 2 Ws.

Strobe frequency: 2.1 Hz = approx. 120 double flashes/min.

Operating temperature: -40 °C to +60 °C.

RF suppression: CISPR 25, class 5 (conducted).

Resistant to high pressure cleaning.

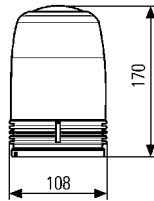

Part no.	Pk.	
2RL 008 366-021	1	Flashing beacon, blue, 12V, with spirally-coiled lead and 2-pole plug for connecting to the cigarette lighter socket
2RL 008 366-031	1	with spirally-coiled lead and Lemo plug
Spare parts/Accessories:		
9EL 862 267-001	1	PC-dome with lens
8GS 859 634-001	1	Xenon tube
8JB 008 839-001	1	Lemo socket for -031

KLX 7000 F

According to DIN 14 620, shape B1.

For permanent mounting. With built-in xenon tube (gas discharge bulb with plug-in base).

Light aperture: 90 mm dia.

Silver coloured metal housing.

Total power consumption: 12V 3.3A, 24V 1.6A.

Operating temperature: -40 °C to +60 °C.

Electrical strobe power: 12 + 2 Ws.

Strobe frequency: 2.05 Hz = double flashes.

RF suppression: CISPR 25, class 5 (conducted).

Resistant to high pressure cleaning.

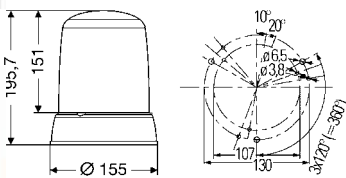

Part no.	Pk.	
2RL 008 181-001	1	Flashing beacon, blue, 12V
2RL 008 181-011	1	blue, 24V
2RL 008 181-101	1	amber, 12V
2RL 008 181-111	1	amber, 24V
Spare parts:		
PC-dome,		
9EL 862 140-021	1	blue
9EL 862 140-031	1	amber
9EL 862 678-001	1	Ring lens with Fresnel optics
9GD 862 679-001	1	Dome seal
8GS 859 634-001	1	Xenon tube
9HB 862 864-001	1	EMC shield for strobe lights
Circuit board (replacement set),		
9MK 862 863-001	1	12V
9MK 862 862-001	1	24V
9GD 862 164-001	1	Rubber spacer, flat

Electronic flashing beacons

KLX 7000 M

According to DIN 14 620, shape B1.
 With magnetic attachment, spirally-coiled lead extends up to 2.5 m and 2-pole plug for connecting to cigarette lighter socket.
 Built-in xenon tube (gas discharge bulb with plug-in base).

Light aperture: 90 mm dia.

Silver coloured metal housing.

Total power consumption: 12V 3.3A, 24V 1.6A.

Operating temperature: -40 °C to +60 °C.

Electrical strobe power: 12 + 2 Ws.

Strobe frequency: 2.05 Hz = double flashes.

RF suppression: CISPR 25, class 5 (conducted).

Resistant to high pressure cleaning.

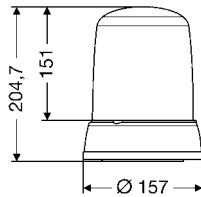

Part no.	Pk.	
2RL 008 182-001	1	Flashing beacon, blue, 12V
2RL 008 182-011	1	blue, 24V
2RL 008 182-101	1	amber, 12V
2RL 008 182-111	1	amber, 24V
Spare parts:		
PC-dome,		
9EL 862 140-021	1	blue
9EL 862 140-031	1	amber
9EL 862 678-001	1	Ring lens with Fresnel optics
9GD 862 679-001	1	Dome seal
8GS 859 634-001	1	Xenon tube
9HB 862 864-001	1	EMC shield for strobe lights
Circuit board (replacement set),		
9MK 862 863-001	1	12V
9MK 862 862-001	1	24V

KLX 7000 FL

According to DIN 14 620, shape A.
 With flexible tubular fitting for support tube, max. inclination 90°.
 Built-in xenon tube (gas discharge bulb with plug-in base).

Light aperture: 90 mm dia.

Silver coloured metal housing.

Total power consumption: 12V 3.3A, 24V 1.6A.

Operating temperature: -40 °C to +60 °C.

Electrical strobe power: 12 + 2 Ws.

Strobe frequency: 2.05 Hz = double flashes.

RF suppression: CISPR 25, class 5 (conducted).

Resistant to high pressure cleaning.

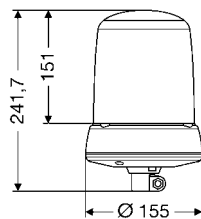

Part no.	Pk.	
2RL 008 183-001	1	Flashing beacon, blue, 12V
2RL 008 183-011	1	blue, 24V
2RL 008 183-101	1	amber, 12V
2RL 008 183-111	1	amber, 24V
Spare parts:		
PC-dome,		
9EL 862 140-021	1	blue
9EL 862 140-031	1	amber
9EL 862 678-001	1	Ring lens with Fresnel optics
9GD 862 679-001	1	Dome seal
8GS 859 634-001	1	Xenon tube
9HB 862 864-001	1	EMC shield for strobe lights
Circuit board (replacement set),		
9MK 862 863-001	1	12V
9MK 862 862-001	1	24V
9NM 863 332-001	1	Wing nut mount

Electronic flashing beacons

KLX

According to DIN 14 620, shape B1.

Built-in xenon tube (gas discharge bulb).

Light aperture: 85 mm dia.

With black plastic body and rubber base plate for permanent mounting.

Three holes for M6 x 35 or M5 x 35 fixing screws.

Total power consumption: 12V 3.3A, 24V 1.7A.

Electrical strobe power: 10+2 Ws.

Strobe frequency: 2.0 Hz = 120 flashes/min.

Operating temperature: -40 °C to +60 °C.

RF suppression: CISPR 25, class 3 (conducted).

Resistant to high pressure cleaning.

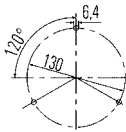
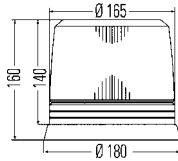

Part no.	Pk.	
2RL 007 017-041	1	Double flasher beacon, blue, 12V
2RL 007 017-051	1	blue, 24V
2RL 007 017-061	1	amber, 12V
2RL 007 017-071	1	amber, 24V
Spare parts:		
9EL 859 658-001	1	PC-dome, blue
9EL 859 658-011	1	amber
9GD 856 466-001	1	Rubber gasket
8GS 863 261-001	1	Xenon tube X1
Accessories:		
9GD 856 863-001	1	Rubber bases (wedge-shaped) for mounting KLX on convex mounting surfaces
8HG 005 436-011	1	Holder for mounting KLX on 24 mm dia. attachment tube
5KG 007 629-001	1	Control unit with contact for control lamp and one beacon, 12V
5KG 007 629-011	1	24V

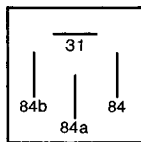

Flashing beacons

RotaLED

In LED-technology. Amber PC dome.

Black rubber housing.

Rated voltage: 12V / 24V.

Supply voltage: 10V - 32V.

Average current consumption: 12V 0,8A, 24V 0,4A.

Consumption: 10W.

Operating temperature: -40 °C to +60 °C.

RF suppression: CISPR 25, class 5 (conducted).

Resistant to high pressure cleaning. Type of protection: IP5KX, IPX4K, IPX9K.

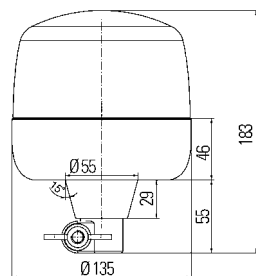
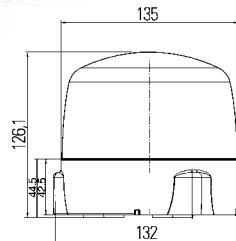
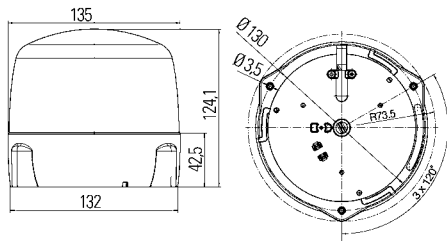

Part no.	Pk.	
2XD 010 979-001	1	LED beacon, amber, according to DIN 14 620, shape B1, for permanent mounting
2XD 010 979-021	1	with magnetic attachment, spirally-coiled lead extends up to 2.5 m and 2-pole plug for connecting to the cigarette lighter socket
2XD 010 979-011	1	LED beacon, amber, according to DIN 14 620, shape A, with tubular fitting for support tube

Flashing beacons

K-LED FO

**In LED-technology. Clear dome with Fresnel optics.
PC body.**

Rated voltage: 12V / 24V.

Supply voltage: 10V - 32V.

Average current consumption: 12V 1,5A, 24V 0,8A.

8 strobe frequencies. Power consumption: 20W.

Lens: PC.

Operating temperature: -40 °C to +60 °C.

RF suppression: CISPR 25, class 5 (conducted).

Resistant to high pressure cleaning. Type of protection: IP5K4K, IPX9K.

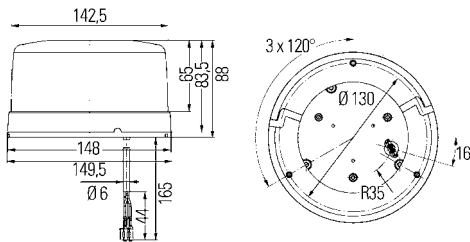

Part no.	Pk.	
2XD 010 311-001	1	LED beacon, amber, according to DIN 14 620, shape B1, for permanent mounting
2XD 010 311-021	1	with magnetic attachment, spirally-coiled lead extends up to 2.5 m and 2-pole plug for connecting to the cigarette lighter socket
2XD 010 311-011	1	LED beacon, amber, according to DIN 14 620, shape A, with tubular fitting for support tube
9EL 174 995-001	1	Spare parts: Dome

Mounting bushes

For beacons with tubular fitting.

With built-in electrical socket to DIN 72 591 and rubber protecting cap.



Part no.	Pk.	
8HG 002 365-001	1	For mounting beacon on support at side of vehicle or for welding to a flange, 24 mm dia., approx 100 mm.
8HG 006 294-101	1	Mounting bush, complete
8HG 006 294-101	1	Mounting bush with separate ground connection
8HG 096 531-007	2	Spare parts: Holder for -001
8JB 850 434-011	10	Socket
9GH 096 532-001	10	Rubber protecting cap
8HG 006 294-051	1	Mounting bush with screw fixing
8HG 006 294-091	1	Mounting bush with screw fixing and separate ground connection
8HG 006 294-011	1	For screwing onto horizontal cabin roofs (on top)
8HG 006 294-021	1	Mounting bush for screwing onto horizontal cabin roofs (on side)
8HG 006 294-111	1	With 90 mm mounting bracket
8HG 006 294-111	1	with 50 mm mounting bracket
8HG 006 294-131	1	Mounting bush with 90° angle of rotation
8HG 006 294-031	1	Mounting bush, can be swivelled, for screwing onto horizontal and vertical cabin roofs
8HG 006 294-141	1	for screwing onto horizontal and vertical cabin roofs (bracket can be adjusted on sloped surfaces)
8HG 006 294-151	1	Extension bar, can be swiveled upwards, for screwing onto horizontal and vertical cabin roofs (bracket can be adjusted on sloped surfaces)
8HG 006 294-041	1	Length: 1000 mm Extension: up to 700 mm. Telescopic holder for screwing onto back of cabin roof.
8HG 990 368-001	1	Black push-on pipe with thread M8. Mounting bush, for screwing onto horizontal cabin roofs (on top)
8HG 990 368-007	50	
8JB 850 434-011	10	Spare parts: Socket
9GH 096 532-001	10	Rubber protecting cap



Mounting bushes

For beacons with tubular fitting

With stopper for screwing to vertical vehicle surfaces (side).
With protective cap, 1-pole socket and wire harness with ground contact.
Attachment using two M8 bolts.

Part no.	Pk.	
9XD 990 284-001	1	Push-on pipe
Spare parts:		
8JB 850 434-011	10	Socket
9GH 096 532-001	10	Rubber protecting cap



Accessory group

For beacons with tubular fitting or flexible base.

Contents: Wing nut with screw and washer.

Part no.	Pk.	
9NM 863 332-001	1	Accessory group



Rubber bases

For mounting on convex mounting surfaces.

Part no.	Pk.	
9GD 860 396-001	1	Rubber base, wedge-shaped, for KL Rotafix
9GD 860 772-001	1	for KL Junior
9GD 862 164-001	1	Rubber spacer for KL/KLX 7000, flat
9GD 863 033-001	1	wedge-shaped

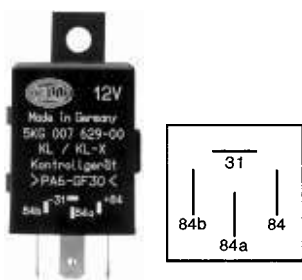

Control units

With contact for control lamp and one beacon.

Part no.	Pk.	
5KG 007 629-001	1	Control unit, 12V
5KG 007 629-011	1	24V



2-pole socket

According to DIN EN ISO 4165. Max. load: 8A at 12V.
With cover and two blade terminal contacts 6.3 mm.

Part no.	Pk.	
8JB 004 777-001	5	2-pole socket

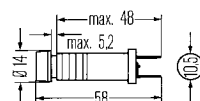





Warning light

For dashboards with thickness of up to 5.2 mm.
With blade terminal connections.

Dust and waterproof screw-type fixing.

Part no.	Pk.	
2AA 003 257-031	10	Warning light, orange

Spare parts for old-type rotating beacons

	Rotating beacon	Dome	1) Body 2) Drive belt 3) Base plate		1) Reflector 2) Motor with snap-in fixing		Bulb	
			Pk.	Pk.	Pk.	Pk.		
KL 600 	2RL 004 957-001 blue, 12V 2RL 004 957-011 blue, 24V	9EL 856 415-001 blue	1	1) for -101 9BG 859 695-101 1	1)	1) with drive belt 9DX 859 560-001 1	8GH 002 089-133 12V55W (H1) 1	
	2RL 004 957-101 amber, 12V 2RL 004 957-111 amber, 24V	9EL 856 416-001 amber	1	for -111 9BG 859 695-111 1 2) 9XR 854 840-001 1 (2 pieces)	2) with drive belt and reflector 9MN 858 616-001 12V 1 9MN 858 616-011 24V 1	8GH 002 089-251 24V70W (H1) 1		
KL 610 	2RL 005 446-00 amber, 12V 2RL 005 446-01 amber, 24V	9EL 856 416-001 amber	1					
KL 700 	2RL 004 958-001 blue, 12V 2RL 004 958-04 blue, 12V 2RL 004 958-011 blue, 24V	9EL 856 417-001 blue	1	2) 9XR 854 840-001 1				
	2RL 004 958-101 amber, 12V 2RL 004 958-14 amber, 12V 2RL 004 958-111 amber, 24V	9EL 856 418-001 amber	1	3) 9GD 856 562-001 1				
KL 710 	2RL 006 295-001 blue, 12V 2RL 006 295-011 blue, 24V	9EL 856 415-001 blue	1	2) 9XR 854 840-001 1				
	2RL 006 295-101 amber, 12V 2RL 006 295-111 amber, 24V	9EL 856 416-001 amber	1	3) 9GD 858 013-001 1				
KL 800 	2RL 004 102-001 blue, 12V 2RL 004 102-011 blue, 24V	9EL 857 801-001 blue	1	2) 9XR 854 840-001 1 (2 pieces)	1)	9DX 859 625-001 1		
	2RL 004 102-101 amber, 12V 2RL 004 102-111 amber, 24V	9EL 857 803-001 amber	1		Contact ring with brush 9MK 854 066-001 1			

Accessories for old-type rotating beacons







	9GD 856 863-001 1	Rubber spacer for KL 700 for KL 710		9GD 859 037-001 1	Rubber spacer for KL 800
	9GD 858 086-001 1				

Rotating Beacons

old-type



Spare parts for old-type rotating beacons



	Rotating beacon	Dome	1) Reflector 2) Base plate		Drive belt (2 pieces)	Bulb		
			Pk.		Pk.	Pk.	Pk.	
KLJ 60 	2RL 003 134-00 blue, 12V 2RL 003 134-01 blue, 24V	9EL 852 061-001 blue	1	1) 9DX 859 560-001 *)	9XR 854 840-001 Contact ring with brush 9MK 854 066-001	1 1	8GH 002 089-133 12V55W (H1)	1
	2RL 003 134-12 amber, 12V 2RL 003 134-13 amber, 24V	9EL 854 912-001 amber	1				8GH 002 089-251 24V70W (H1)	1
KLJ 70 	2RL 003 130-08 blue, 12V 2RL 003 130-09 blue, 24V							
	2RL 003 130-12 amber, 12V 2RL 003 130-14 amber, 24V							
KLJ 80 	2RL 003 129-00 blue, 12V 2RL 003 129-01 blue, 24V	9EL 852 820-001 blue	1	1) 9DX 859 625-001 *)				
	2RL 003 129-10 amber, 12V 2RL 003 129-11 amber, 24V	9EL 855 097-001 amber	1					
2RL 002 472-... 	2RL 002 472-00 amber, 220V	9EL 854 912-001 gelb	1	-	-	Motor with gear unit, 240V 9MN 854 290-001	-	-
	2RL 002 472-01 red, 220V	9EL 852 061-021 red	1		1			
	2RL 002 472-02 green, 220V							
2RL 005 403-... 	2RL 005 403-00 amber, 220V	9EL 856 418-001 amber	1	2) 9GD 856 562-001	1			
	2RL 005 403-10 red, 220V	9EL 856 418-011 red	1					
2RL 006 811-... 	2RL 006 811-00 amber, 220V	9EL 856 416-001 amber	1	2) 9GD 858 013-001	1			
	2RL 006 811-01 red, 220V	9EL 856 416-011 red	1					

*) If motor base plate is metal, order reflector and motor (2 parts), if plastic, order only defective part (reflector or motor)



Accessories for old-type rotating beacons

	9GD 854 019-001	5	Rubber spacer for 2RL 003 129-...
---	------------------------	---	--

Spare parts for old-type flashing beacons

	Flashing beacon	Dome	Rubber spacer		Power supply		Xenon strobe with reflector	
			Pk.	Pk.	Pk.	Pk.		
KLX 	2RL 007 017-00 blue, 12V 2RL 007 017-02 blue, 24V	9EL 859 658-001 blue 9EL 859 658-011 amber	1	1	-	-	-	-
	2RL 007 017-011 amber, 12V 2RL 007 017-031 amber, 12V	9EL 859 658-011 amber	1					
BSX-Micro 	2XD 008 605-80 blue, 12V 2XD 008 605-81 blue, 24V	Strobe beacon, blue 2XD 861 423-031	1	-	-	-	8GS 861 710-001	1
BSX-Compact 	2XD 007 853-80 blue, 12V 2XD 007 853-81 blue, 24V	-	-	-	8ES 861 420-001 12V 8ES 861 420-011 24V	1	-	-

Accessories for old-type flashing beacons

	9GD 856 863-001	1	Rubber spacer		5KG 007 629-001 5KG 007 629-011	1	Control unit, 12V
	8HG 005 436-011	1	Holder for tubular fitting				24V

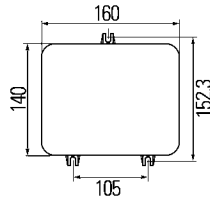

Flashing beacons BSX-Multi

2 blue strobe beacons with built-in xenonflash tubes, with 5,0 m long lead and power supply for synchronous strobe sequence, in stable extruded aluminium body.
Light aperture: 110 x 130 mm.

Technical data:

Rated voltage: 12V / 24V.
Operating voltage: 10V - 15V at 12V, 20V - 30V at 24V.
Strobe frequency: 2.1 Hz = approx. 120 double flashes/min.
Electrical strobe power: 2 x (6.5 + 1.5 Ws).
Power consumption: 3.8A at 12V, 1.8 at 24V.
Operating temperature: -40 °C to +60 °C.
RF suppression: CISPR 25, class 5 (conducted).
Type of protection strobe beacon:
resistant to high pressure cleaning.
Type of protection power supply VSE-X: dustproof.

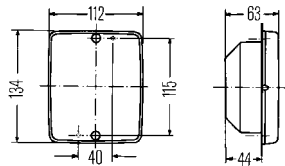
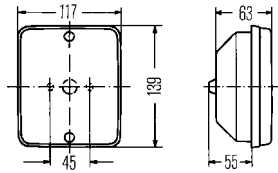

Part no.	Pk.	
		For front flush or surface mounting. Black plastic housing. Two M5 fixing screws.
2XD 008 135-801	1	Flashing beacon set, blue, 12V
2XD 008 135-811	1	Flashing beacon set, blue, 24V
		Spare parts:
2XD 862 019-011	1	Flashing beacon, blue
9ES 862 011-001	5	Lens, blue
8GS 862 014-001	1	Xenon tube
		Power supply,
8ES 861 420-001	1	12V
8ES 861 420-011	1	24V
		For front mounting. Black rubber housing. Two BZ4,2 fixing screws.
2XD 008 135-821	1	Flashing beacon set, blue, 12V
2XD 008 135-831	1	Flashing beacon set, blue, 24V
		Spare parts:
2XD 862 111-011	1	Flashing beacon, blue
9ES 862 011-001	1	Lens, blue
9BG 121 740-001	1	Rubber body
8GS 862 014-001	1	Xenon tube
		Power supply,
8ES 861 420-001	1	12V
8ES 861 420-011	1	24V

Flashing beacons BSX-Micro

Contents: 2 blue strobe beacons with built-in xenonflash tubes, 3.5 m connecting lead and power unit for synchronous strobe sequence, in stable extruded aluminium housing. Light aperture: 90 x 60 mm.

Technical data:

Rated voltage: 12V / 24V.
 Operating voltage: 0V - 15V at 12V, 20V - 30V at 24V.
 Strobe frequency: 2.1 Hz = approx. 120 double flashes/min.
 Electrical strobe power: 2 x (6 + 1,5 Ws).
 Power consumption: 3.3A at 12V, 1.5A at 24V.
 Operating temperature: -40 °C to +60 °C.
 RF suppression: CISPR 25, class 5 (conducted).
 Type of protection strobe beacon: resistant to high pressure cleaning.
 Type of protection power supply VSE-X: dustproof.

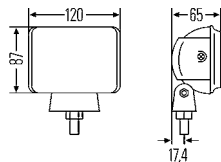
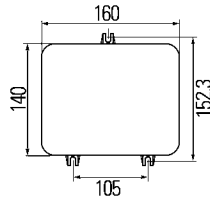

Part no.	Pk.	
		With push-in adapter mounting set. Black plastic body.
2XD 007 854-801	1	Flashing beacon set, blue, 12V
2XD 007 854-811	1	Flashing beacon set, blue, 24V
		Spare parts:
2XD 861 423-011	1	Flashing beacon, blue
9ES 861 711-001	1	Lens, blue, with screws and gasket
8GS 861 710-001	1	Xenon strobe with reflector
		Power supply,
8ES 861 420-001	1	12V
8ES 861 420-011	1	24V
		With push-in adapter mounting set. Black plastic body.
2XD 007 854-821	1	Flashing beacon set, amber, 12V
2XD 007 854-831	1	Flashing beacon set, amber, 24V
		Spare parts:
2XD 861 423-021	1	Flashing beacon, amber
8GS 861 710-001	1	Xenon strobe with reflector
		Power supply,
8ES 861 420-001	1	12V
8ES 861 420-011	1	24V

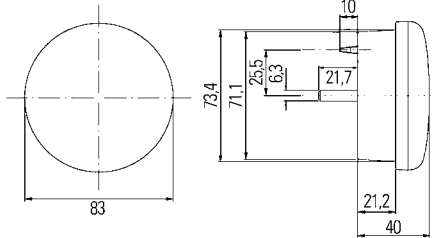

Flashing beacons

For flush mounting in the vehicle front.
Amber lens.

With twelve LEDs 3,0W and 2500 mm long lead.

Voltage range: 9V - 33V.

Consumption: 0,13A at 12V/24V.

Part no.	Pk.	
2XD 959 011-021	1	LED flashing beacon, amber, 12V/24V

BSN-LED

Content: Two LED beacons with 300 mm lead
with AMP plug.

Four Power-LED each. Clear lens.

Light aperture: 122 x 41 mm.

Choice of signals:

- 10 flashing sequences including a random Hella Random Flash flashing sequence.

- synchronous or alternating signal

- 100 Hz permanent signal

Technical data:

Voltage range: 9V - 32V.

Power consumption: 0.8A at 12V, 0.4A at 24V.

Operating temperature: -40 °C to +60 °C.

Type of protection: IP5K4K9K.

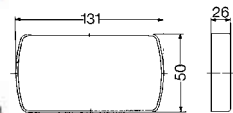

Part no.	Pk.	
2XD 010 312-801	1	Black metal housing. Six holes for fixing screws. LED flashing beacon set, blue, 12V/24V
2XD 010 312-811	1	LED flashing beacon set, amber, 12V/24V

Rear warning lights

WL-LED

With 12 built-in LEDs. Clear lens.
Up to 8 strobe sequences can be coded,
synchronous as well as alternating,
for synchronisation of 2, 3 or 4 lamps.

Technical data:

Rated voltage: 12V / 24V.
Operating voltage: 10V - 15V at 12V, 20V - 30V at 24V.
Power consumption: 0.7A at 12V, 0.35A at 24V.
Strobe frequency: 2 Hz.
Polarity reversal protection: yes.
Operating temperature: -40 °C to +60 °C.
RF suppression: CISPR 25, class 5 (conducted).

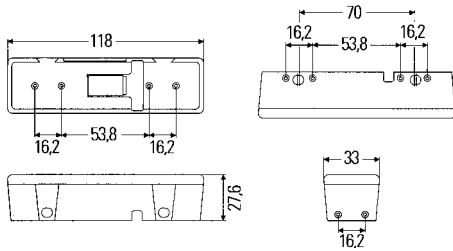

Part no.	Pk.	
		Without mounting frame. Black plastic body.
2XD 008 997-001	1	LED rear warning light, blue, 12V
2XD 009 048-001	1	LED rear warning light, blue, 24V
		With mounting frame. Black plastic body.
2XD 008 997-201	1	LED rear warning light, blue, 12V
2XD 009 048-201	1	LED rear warning light, blue, 24V
		Accessories:
9XD 863 533-001	1	Angular bracket (2 pcs.) including 4 screws
9XD 863 828-001	1	Built-in frame of black coated aluminium, adjustable bracket, including 4 screws



Rear warning lights

C-LED

Corner light for installation in pairs at the vehicle rear. In connection with two blue beacons in the front area, the C-LED corner light system achieves a 360° all-around warning effect.

Technical data:

Rated voltage: 12V / 24V.
 Operating voltage: 12V - 30V at 12V, 18V - 32V at 24V.
 Power consumption: (each C-LED modul)
 300 mA at 12V, 150 mA at 24V.
 Operating temperature: -40 °C to +60 °C.
 RF suppression: CISPR 25, class 5 (conducted).
 Resistant to high pressure cleaning.

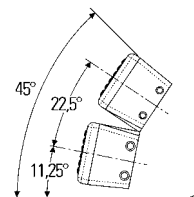
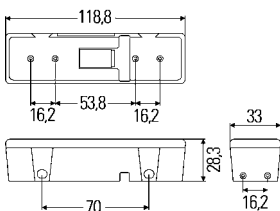
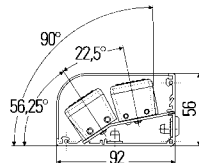
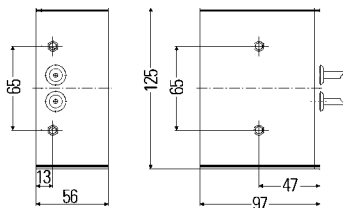
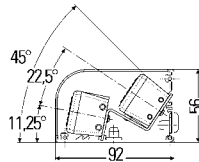
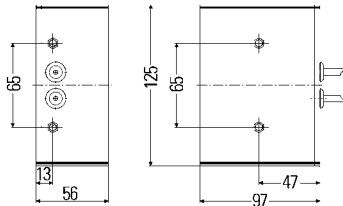
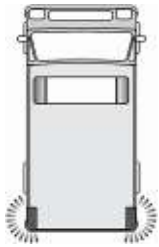

Part no.	Pk.	
		Installation variant 1. With blue PC lens and 24 LEDs. Silver coloured aluminium body.
2XD 009 475-021	1	LED rear warning light, blue, 12V
2XD 009 475-001	1	LED rear warning light, blue, 24V
		Installation variant 2. With 24 LEDs, blue PC lens and Silver coloured aluminium body.
2XD 009 475-031	1	LED rear warning light, blue, 12V
2XD 009 475-011	1	LED rear warning light, blue, 24V
		Accessories: Control unit, 12V / 24V (one control unit is necessary for every C-LED corner light)
5KG 009 713-001	1	

C-LED Modul

Single component for vertical, installation in pairs at the vehicle rear (4 C-LED modules are required).

Please observe defined angle arrangement.

Part no.	Pk.	
		With 24 LEDs. Clear lens. Black plastic body.
2XD 008 997-101	1	LED rear warning light, blue, 12V
2XD 009 048-101	1	LED rear warning light, blue, 24V
		Accessories: Control unit, 12V / 24V, one control unit is necessary for every 2 C-LED modules Switch with warning light for connection to the control unit
5KG 009 713-001	1	
6ED 004 778-001	1	

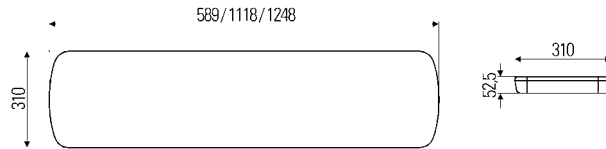

Optical warning systems Raptor with LED trough module system, 589 mm, 1118 mm, 1248 mm

For medium-sized to large special-purpose, heavy goods vehicles, street-cleaning vehicles, etc. With clear PC dome and 8 LED modules.

Aluminiumbase plate.
 Technical data:
 Rated voltage: 12V.
 Operating voltage range: 9V - 16V.
 Average current consumption: 1,2A.
 Flashing sequence: double.
 Operating temperature: - 20 °C to + 60 °C.
 RF suppression: CISPR 25, class 5 (conducted).
 EMC protection. Type of protection: IP5K4K and IPX9K.

Part no.	Pk.	
2RL 010 743-001	1	Raptor (LED-Signal Bar), 589 mm, amber, 12V
2RL 010 743-141	1	blue, 12V
<hr/>		
2RL 010 743-091	1	Raptor (LED-Signal Bar), 1118 mm, amber, 12V
2RL 010 743-011	1	blue, 12V
2RL 010 743-041	1	Raptor (LED-Signal Bar), 1118 mm, with rear LED moving light signal (LSB), amber, 12V
2RL 010 743-051	1	Raptor (LED-Signal Bar), 1118 mm, with two side-mounted lights incl. LEDs, amber, 12V
2RL 010 743-101	1	blue, 12V
2RL 010 743-061	1	Raptor (LED-Signal Bar), 1118 mm, with rear LED moving light signal (LSB) and two side-mounted lights incl. LEDs, amber, 12V
2RL 010 743-111	1	blue, 12V
<hr/>		
2RL 010 743-021	1	Raptor (LED-Signal Bar), 1248 mm, amber, 12V
2RL 010 743-151	1	blue/red, 12V
2RL 010 743-031	1	Raptor (LED-Signal Bar), 1248 mm, with rear LED moving light signal (LSB), amber, 12V
2RL 010 743-071	1	Raptor (LED-Signal Bar), 1248 mm, with two side-mounted lights incl. LEDs, amber, 12V
2RL 010 743-121	1	blue, 12V
2RL 010 743-081	1	Raptor (LED-Signal Bar), 1248 mm, with rear LED moving light signal (LSB) and two side-mounted lights incl. LEDs, amber, 12V
2RL 010 743-131	1	blue, 12V



Control unit

Part no.	Pk.	
9SX 178 258-001	1	Control unit for LED moving light signal (LSB)



Bracket for four-point fixing

Contents:
2 brackets made of stainless steel with fixing material

Part no.	Pk.	
8HG 168 011-001	1	Bracket for four-point fixing



Magnet bracket

Contents:
4 magnets with fixing material

Part no.	Pk.	
9MA 864 153-801	1	Magnet bracket

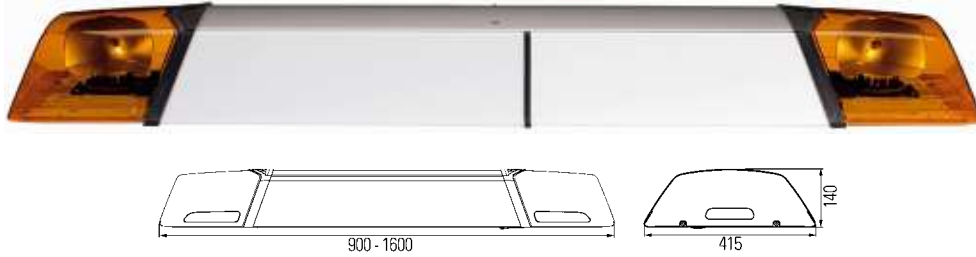

Optical warning systems OWS 7 with single reflector system KL-ER 900 mm, 1000 mm, 1100 mm, 1400 mm, 1600 mm

For medium-sized to large special-purpose vehicles.

With two amber PC domes and H1 bulbs.

Light aperture (reflector dia.): 84 mm.

Modular design with a length range from 900 mm to a possible 1600 mm.

As auxiliary lighting systems, adjustable with two LED side-mounted lights for side illumination or integrated H3 worklights (facing the front or rear) can be optionally selected.

Technical data:

Rated voltage: 12V.

Operating voltage range: 10.8V - 13.8V at 12V.

Power consumption of rotating beacons: 9.4A at 12V.

Belt drive: n = 160 rpm.

Operating temperature: - 40 °C to + 60 °C.

RF suppression: CISPR 25, class 5 (conducted).

Resistant to high pressure cleaning.

Weight: max. 25 kg.

Part no.	Pk.	
2RL 010 710-101	1	Optical warning system OWS 7 with single reflector system KL-ER, 900 mm, amber, 12V
2RL 010 710-111	1	Optical warning system OWS 7 with single reflector system KL-ER, 1000 mm, amber, 12V
2RL 010 710-121	1	Optical warning system OWS 7 with single reflector system KL-ER, 1100 mm, amber, 12V
2RL 010 710-211	1	amber, 12V, with two side-mounted lights incl. LEDs
2RL 010 710-131	1	Optical warning system OWS 7 with single reflector system KL-ER, 1400 mm, amber, 12V
2RL 010 710-221	1	amber, 12V, with two side-mounted lights incl. LEDs
2RL 010 710-141	1	Optical warning system OWS 7 with single reflector system KL-ER, 1600 mm, amber, 12V
		Spare parts:
9EL 172 563-251	1	Dome, amber, without cutout
9EL 172 563-351	1	with cutout
8GH 002 089-133	1	H1-bulb, 12V55W

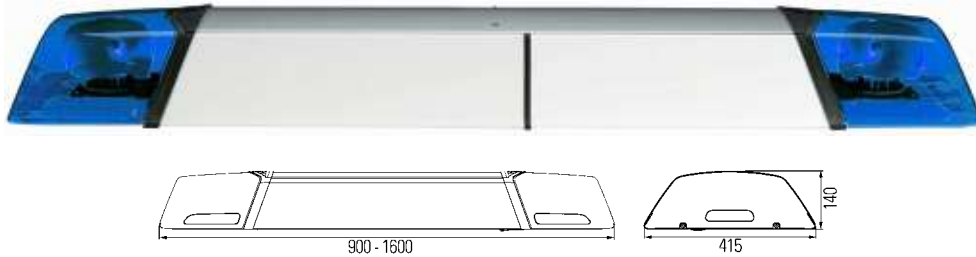

Optical warning systems OWS 7 with single reflector system KL-ER, 1000 mm, 1100 mm, 1200 mm, 1400 mm, 1500 mm

For medium-sized to large special-purpose vehicles.

With two blue PC domes and H1 bulbs.

Light aperture (reflector dia.): 84 mm.

Modular design with a length range from 900 mm to a possible 1600 mm.

As auxiliary lighting systems, adjustable with two LED side-mounted lights for side illumination or integrated H3 worklights (facing the front or rear) can be optionally selected.

Technical data:

Rated voltage: 12V.

Operating voltage range: 10.8V - 13.8V at 12V.

Power consumption of rotating beacons: 9.4A at 12V.

Belt drive: n = 160 rpm.

Operating temperature: - 40 °C to + 60 °C.

RF suppression: CISPR 25, class 5 (conducted).

Resistant to high pressure cleaning.

Weight: max. 25 kg.

Part no.	Pk.	
2RL 010 713-211	1	Optical warning system OWS 7 with single reflector system KL-ER, 1000 mm, blue, 12V
2RL 010 713-111	1	blue, 12V, with stop signal ASG-Matrix
2RL 010 713-171	1	Optical warning system OWS 7 with single reflector system KL-ER, 1100 mm, blue, 12V
2RL 010 713-161	1	Optical warning system OWS 7 with single reflector system KL-ER, 1200 mm, blue, 12V
2RL 010 713-231	1	Optical warning system OWS 7 with single reflector system KL-ER, 1400 mm, blue, 12V
2RL 010 713-091	1	Optical warning system OWS 7 with single reflector system KL-ER, 1500 mm, blue, 12V, with two H3 work lights incl. bulbs to the back and LSB (LED Signal-Bar to hedge to the back)
8GH 002 089-133	1	Spare parts: H1-bulb, 12V55W

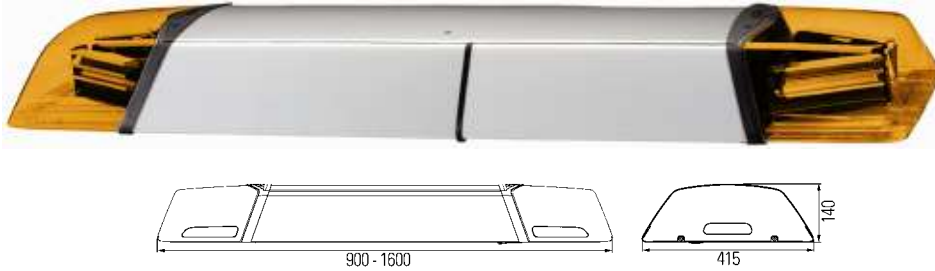

Optical warning system OWS 7 with LED trough module system KL-LR2, 900 mm, 1000 mm, 1100 mm, 1300 mm, 1400 mm, 1600 mm

For medium-sized to large special-purpose vehicles.

With two amber PC domes and 2 x 2 reflectors with 30 amber LEDs.

Modular design with a length range from 900 mm to a possible 1600 mm.

As auxiliary lighting systems, adjustable with two LED side-mounted lights for side illumination or integrated H3 worklights (facing the front or rear) can be optionally selected.

Technical data:

Rated voltage: 12V. Operating temperature: - 40 °C to + 60 °C.

RF suppression: CISPR 25, class 3 (conducted).

Resistant to high pressure cleaning. Weight: max. 25 kg.

Part no.	Pk.	
2RL 010 710-151	1	Optical warning system OWS 7 with LED trough module system KL-LR2, 900 mm, amber, 12V
2RL 010 710-161	1	Optical warning system OWS 7 with LED trough module system KL-LR2, 1000 mm, amber, 12V
2RL 010 710-231	1	amber, 12V, with two side-mounted lights incl. LEDs
2RL 010 710-041	1	amber (clear domes), 12V, with two work lights incl. LEDs each to the front and each to the back
2RL 010 713-001	1	blue, 12V
2RL 010 710-171	1	Optical warning system OWS 7 with LED trough module system KL-LR2, 1100 mm, amber, 12V
2RL 010 710-241	1	amber, 12V, with two side-mounted lights incl. LEDs
2RL 010 710-021	1	amber, 12V, with two H3 work lights incl. bulbs to the back
2RL 010 710-071	1	amber (clear domes), 12V, with two side-mounted lights incl. LEDs and two work lights incl. LEDs each to the front and each to the back
2RL 010 710-061	1	Optical warning system OWS 7 with LED trough module system KL-LR2, 1200 mm, amber (clear domes), 12V, with two H3 work lights incl. bulbs to the back
2RL 010 710-011	1	Optical warning system OWS 7 with LED trough module system KL-LR2, 1300 mm, amber, 12V, with two H3 work lights incl. bulbs to the back and LSB (LED Signal-Bar to hedge to the back)
2RL 010 710-181	1	Optical warning system OWS 7 with LED trough module system KL-LR2, 1400 mm, amber, 12V
2RL 010 710-251	1	amber, 12V, with two side-mounted lights incl. LEDs
2RL 010 710-031	1	amber, 12V, with two side-mounted lights incl. LEDs and two H3 work lights to the front
2RL 010 710-051	1	amber, 12V, with two H3 work lights to the front
2RL 010 710-191	1	Optical warning system OWS 7 with LED trough module system KL-LR2, 1600 mm, amber, 12V
2RL 010 710-261	1	amber, 12V, with two side-mounted lights incl. LEDs
2RL 010 710-281	1	amber, 12V, with two side-mounted lights incl. LEDs and two H3 work lights incl. bulbs to the back
		Spare parts:
9EL 172 563-251	1	Dome, amber, without output
9EL 172 563-351	1	Dome, amber, with output

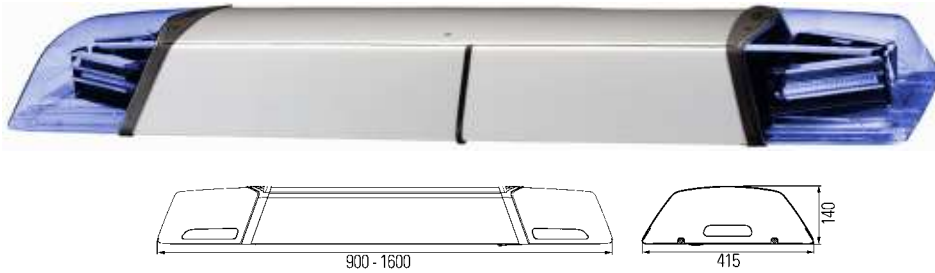

Optical warning system OWS 7 with LED trough module system KL-LR2, 1000 mm, 1300 mm, 1400 mm, 1500 mm

For medium-sized to large special-purpose vehicles.

With two blue PC domes and 2 x 2 reflectors with 24 LEDs for blue light.

Modular design with a length range from 900 mm to a possible 1600 mm.

As auxiliary lighting systems, adjustable with two LED side-mounted lights for side illumination or integrated H3 worklights (facing the front or rear) can be optionally selected.

Technical data:

Rated voltage: 12V. Operating temperature: - 40 °C to + 60 °C.

RF suppression: CISPR 25, class 3 (conducted).

Resistant to high pressure cleaning. Weight: max. 25 kg.

Part no.	Pk.	
2RL 010 713-001	1	Optical warning system OWS 7 with LED trough module system KL-LR2, 1000 mm, blue, 12V
2RL 010 713-101	1	Optical warning system OWS 7 with LED trough module system KL-LR2, 1300 mm, blue, 12V, with two H3 work lights incl. bulbs to the back and LSB (LED Signal-Bar to hedge to the back)
2RL 010 713-011	1	Optical warning system OWS 7 with LED trough module system KL-LR2, 1400 mm, blue, 12V, with two side-mounted lights incl. LEDs, stop signal ASG-Matrix and LSB (LED Signal-Bar to hedge to the back), for VW T5
2RL 010 713-021	1	blue, 12V, with two side-mounted lights incl. LED's and ASG-Matrix
2RL 010 713-041	1	blue, 12V, with stop signal ASG-Matrix and LSB (LED Signal-Bar to hedge to the back)
2RL 010 713-051	1	blue, 12V, with two H3 work lights incl. bulbs to the back and LSB (LED Signal-Bar to hedge to the back)
2RL 010 713-061	1	blue, 12V, with two side-mounted lights incl. LEDs and LSB (LED Signal-Bar to hedge to the back)
2RL 010 713-071	1	blue, 12V, with two side-mounted lights incl. LEDs and amber indicator lights to the back
2RL 010 713-081	1	blue, 12V, with one H3 work lights incl. bulbs to the back
2RL 010 713-121	1	blue, 12V, with two side-mounted lights incl. LEDs, one H3 work light incl. bulb to the back and amber indicator lights to the back
2RL 010 713-151	1	blue, 12V, with two H3 work lights incl. bulbs to the back and LSB (LED Signal-Bar to hedge to the back)
2RL 010 713-031	1	Optical warning system OWS 7 with LED trough module system KL-LR2, 1500 mm, blue, 12V, with two H3 work lights incl. bulbs to the back and LSB (LED Signal-Bar to hedge to the back)

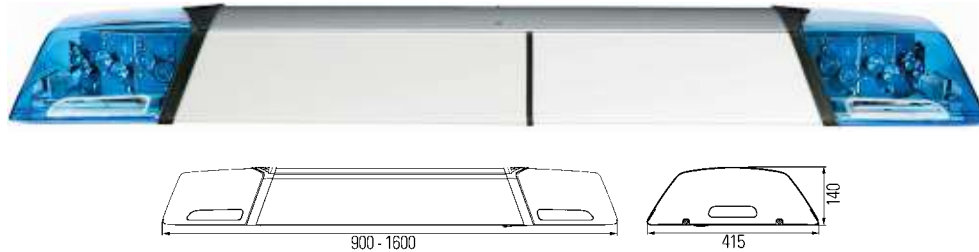

Optical warning system OWS 7 with LED 2-level module system KL-LM2 (day/night switching system), 1300 mm, 1400 mm, 1600 mm

For medium-sized to large special-purpose vehicles.

With two blue PC domes and 16 high-performance LEDs in each case, with direct emission for longer flash at daylight.

Modular design with length variance from 900 mm to 1600 mm at 100 mm intervals.

As additional lighting systems, adjustable headlamps "Alley Lights", integrated work lamps (to front or rear), stop signal generator or LED signal bar can optionally be selected.

Technical data:

Rated voltage: 12V.

Current consumption of the module equipment: KL-LM2 (2 levels day): 2,7A.

Power consumption: (2 levels day): 36W.

Operating temperature: -40 °C bis +60 °C.

RF suppression: CISPR 25, class 3 (conducted).

Resistant to high-pressure jet cleaners.

Weight: max. 25 kg depending on features.

Part no.	Pk.	
2RL 010 713-201	1	Optical warning system OWS 7 with LED 2-level module system KL-LM2, 1300 mm, blue, 12V, with two side-mounted lights incl. LEDs and LSB (LED Signal-Bar to hedge to the back)
2RL 010 713-141	1	Optical warning system OWS 7 with LED 2-level module system KL-LM2, 1400 mm, blue, 12V, LSB (LED Signal-Bar to hedge to the back)
2RL 010 713-181	1	blue, 12V, with two side-mounted lights incl. LEDs and LSB (LED Signal-Bar to hedge to the back)
2RL 010 713-191	1	blue, 12V, with one H3 work light incl. bulb to the back and LSB (LED Signal-Bar to hedge to the back)
2RL 010 713-131	1	Optical warning system OWS 7 with LED 2-level module system KL-LM2, 1600 mm, blue, 12V, with two side-mounted lights incl. LEDs and one H3 work light incl. bulb to the back
2RL 010 713-221	1	blue, 24V

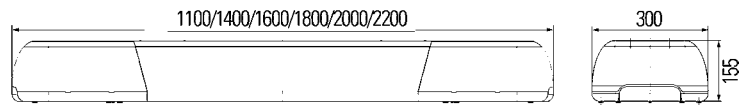

Part no.	Pk.	
2RL 009 688-...		Optical warning system OWS-QS, only accessories and spare parts available
2RL 009 279-...		Optical warning system OWS-QS, only accessories and spare parts available
		Spare parts:
		Dome,
9EL 863 117-071	1	amber (KL-ER, KL-MR, KL-XL2, KL-XR2)
9EL 863 117-141	1	blue (KL-LR2)
		Rotating mirror module (KL-ER),
2RL 863 132-021	1	12V
2RL 863 132-031	1	24V
9XR 855 975-001	1	Drive belts (2 pieces) (KL-ER)
		Double flashing module (KL-XL2),
2RL 863 106-001	1	12V
2RL 863 106-011	1	24V
8GS 859 634-001	1	Xenon tube (KL-XL2)
		Flashing module (KL-XR2),
2RL 863 123-001	1	12V
2RL 863 123-011	1	24V
8GS 883 889-001	1	Xenon tube (KL-XR2)
1GA 008 284-101	1	Side-mounted light Alley Light

Bulb holder

For illumination of the middle panel,
(2 pieces for OWS-QS 1400 mm/1600 mm/1800 mm).



Part no.	Pk.	
9FT 861 790-021	1	Bulb holder with 12V bulb
9FT 861 790-031	1	with 24V bulb
Spare parts:		
8GP 003 594-121	1	W5W bulb, 12V
8GP 003 594-251	1	24V

Push-pull switch

With red warning light, without bulb.



Part no.	Pk.	
6ED 004 778-011	2	Push-pull switch
Accessories:		
8GP 002 095-121	10	W5/1,2 bulb, 12V1,2W
8GP 002 095-241	10	24V1,2W

Rubber bases



Part no.	Pk.	
For 1100 mm systems.		
9GD 864 285-001	1	Rubber spacer, flat
9GD 864 286-001	1	Rubber base, wedge-shaped
For 1400 mm systems.		
9GD 864 286-011	1	Rubber base, wedge-shaped
For 1600 mm systems.		
9GD 864 286-021	1	Rubber base, wedge-shaped
For all versions.		
9GD 863 122-001	1	Installation kit

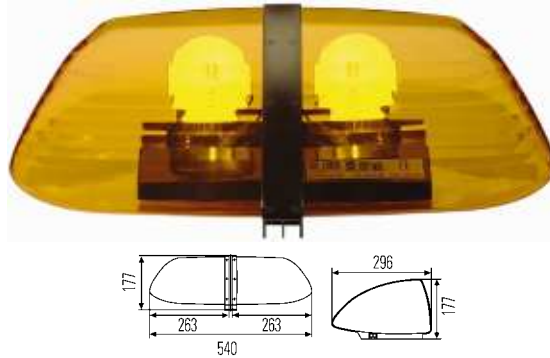

Optical warning systems OWS 540, 540 mm

For tow-service vehicles, public-authority vehicles and excessively long or excessively wide trucks.

With two domes, rubber gasket and H1 bulbs.

Light aperture (reflector dia.): 83 mm.

Amber and blue domes with optical pattern.

One 4 m long connection lead is supplied with optical warning system.

Technical data:

Rated voltage: 12V / 24V.

Operating voltage range: 10V - 15.5V at 12V, 20V - 31V at 24V.

Power consumption (rated voltage) of rotating beacons: 9.4A at 12V, 5.4A at 24V.

Operating temperature: -40 °C to +60 °C.

RF suppression: CISPR 25, class 5 (conducted).

Resistant to high pressure cleaning. Weight: max. 5 kg.

Part no.	Pk.	
		Optical warning system OWS 540, 540 mm,
		amber, 12V
2RL 007 900-501	1	amber, 12V
2RL 007 900-521	1	amber, 12V, with magnetic attachment
2RL 007 900-511	1	amber, 24V
2RL 007 900-551	1	blue, 12V
2RL 007 900-561	1	blue, 24V
		Spare parts:
		Dome, amber,
9EL 861 912-001	1	left
9EL 861 913-001	1	right
		Dome, blue,
9EL 861 912-021	1	left
9EL 861 913-021	1	right
		Reflector
9DX 861 872-001	1	for amber OWS, with reflector made of plastic (for systems up to model year 2002)
9DX 862 849-001	1	for amber OWS, with reflector made of metal
9DX 861 976-001	1	for blue OWS
9MN 860 677-021	1	Motor 12V/24V
		H1 bulb,
8GH 002 089-133	1	12V55W
8GH 002 089-251	1	24V70W

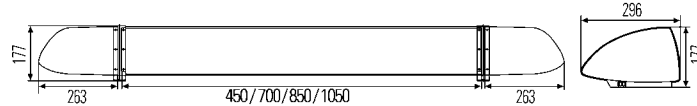

Optical warning system

OWS 1000, 1000 mm. OWS 1250, 1250 mm. OWS 1400, 1400 mm. OWS 1600, 1600 mm

For tow-service vehicles, public-authority vehicles and excessively long or excessively wide trucks.

With two domes and panels designed to take lettering.

With H1 bulbs. Light aperture (reflector dia.): 83 mm.

Amber and blue domes with optical pattern.

One 4 m long connection lead is supplied with optical warning system.

Technical data:

Rated voltage: 12V / 24V.

Operating voltage range: 10V - 15.5V at 12V, 20V - 31V at 24V.

Power consumption (rated voltage) of rotating beacons: 9.4A at 12V, 5.4A at 24V.

Operating temperature: -40 °C to +60 °C.

RF suppression: CISPR 25, class 5 (conducted).

Resistant to high pressure cleaning. Weight: max. 5 kg.

Part no.	Pk.	
		Optical warning system, OWS 1000, 1000 mm, with white panel,
2RL 007 900-001	1	amber, 12V
2RL 007 900-151	1	blue, 12V
		Optical warning system, OWS 1000, 1000 mm, with amber panel (FLN colour 1641),
2RL 007 900-191	1	amber, 12V
		Optical warning system, OWS 1400, 1400 mm, with white panel,
2RL 007 900-201	1	amber, 12V
2RL 007 900-211	1	amber, 24V
2RL 007 900-251	1	blue, 12V
		Optical warning system, OWS 1400, 1400 mm, with amber panel (FLN colour 1641),
2RL 007 900-291	1	amber, 12V
		Optical warning system, OWS 1600, 1600 mm, with white panel,
2RL 007 900-601	1	amber, 12V
2RL 007 900-611	1	amber, 24V
		Spare parts:
		Dome, amber,
9EL 861 912-001	1	left
9EL 861 913-001	1	right
		Dome, blue,
9EL 861 912-021	1	left
9EL 861 913-021	1	right
		White panel,
9EL 861 498-001	1	for OWS 1000 mm
9EL 861 498-011	1	for OWS 1400 mm
9EL 861 498-021	1	for OWS 1600 mm
		Reflector
9DX 861 872-001	1	for amber OWS, with reflector made of plastic (for systems up to model year 2002)
9DX 862 849-001	1	for amber OWS, with reflector made of metal
9DX 861 976-001	1	for blue OWS
9MN 860 677-021	1	Motor, 12V/24V
		H1 bulb,
8GH 002 089-133	1	12V55W
8GH 002 089-251	1	24V70W

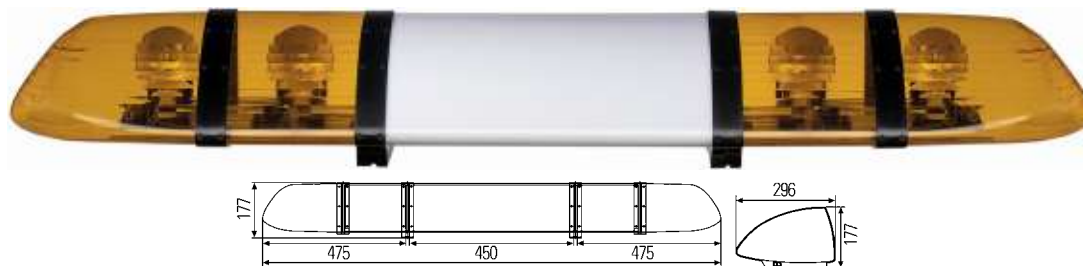

Optical warning system OWS-MR, 1400 mm

For tow-service vehicles, public-authority vehicles and excessively long or excessively wide trucks.

With two domes and white panels designed to take lettering and H1 bulbs.

Light aperture (reflector dia.): 2 x 83 mm.

PC dome with optical pattern.

One 4 m long connection lead is supplied with optical warning system.

Technical data:

Rated voltage: 12V.

Operating voltage range: 10V - 15.5V at 12V.

Power consumption: 19.5A.

Operating temperature: -40 °C to +60 °C.

RF suppression: CISPR 25, class 5 (conducted).

Resistant to high pressure cleaning.

Weight: 7 kg.

Part no.	Pk.	
2RL 007 900-701	1	Optical warning system OWS-MR, 1400 mm, amber, 12V
		Spare parts:
9EL 861 912-001	1	Dome, amber, left
9EL 861 913-001	1	right
		Spare parts:
8GH 002 089-133	1	H1-bulb, 12V55W

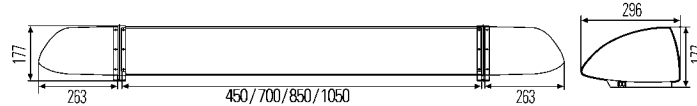

Optical warning system

OWS-X 1000, 1000 mm. OWS-X 1400, 1400 mm. OWS-X 1600, 1600 mm

**For tow-service vehicles, public-authority vehicles and excessively long or excessively wide trucks.
With two domes and white panels designed to take lettering.**

Amber and blue domes with optical pattern.

One 4 m long connection lead is supplied with optical warning system.

Technical data:

Rated voltage: 12 / 24V.

Operating voltage range: 10V - 15V at 12V, 20V - 30V at 24V.

Strobe frequency: 2.05 Hz double flashes.

Power consumption of flashing beacons: 7A bei 12V, 3,2A bei 24V.

Operating temperature: -40 °C to +60 °C.

RF suppression: CISPR 25, class 5 (conducted).

Resistant to high pressure cleaning.

Weight: max. 9 kg.

Part no.	Pk.	
		Optical warning system, OWS-X 1000, 1000 mm
2RL 007 900-121	1	amber, 12V
2RL 007 900-171	1	blue, 12V
		Optical warning system, OWS-X 1400, 1400 mm
2RL 007 900-221	1	amber, 12V
2RL 007 900-241	1	amber, 24V
		Optical warning system, OWS-X 1600, 1600 mm
2RL 007 900-631	1	amber, 24V
2RL 007 900-681	1	blue, 24V
		Spare parts:
		Dome, amber,
9EL 861 912-041	1	left
9EL 861 913-041	1	right
		Dome, blue,
9EL 861 912-051	1	left
9EL 861 913-051	1	right
		Double flashing module,
2RL 863 106-001	1	12V
2RL 863 106-011	1	24V
8GS 859 634-001	1	Xenon tube X1
		White panel,
9EL 861 498-001	1	for OWS 1000 mm
9EL 861 498-011	1	for OWS 1400 mm
9EL 861 498-021	1	for OWS 1600 mm

Accessories for OWS- and OWS-X 540 to 1600



Panels



Part no.	Pk.	
For OWS- and OWS-X 1000		
9HB 862 827-041	1	Panel with work lights
9HB 862 827-031	1	Panel with tail lights
For OWS- and OWS-X 1400		
9HB 862 827-051	1	Panel with work lights
9HB 862 827-071	1	Panel with flasher lights and work lights
9HB 862 827-091	1	Panel with tail- and flasher lights
9HB 862 827-011	1	Panel with flasher lights
For OWS- and OWS-X 1600		
9HB 862 827-061	1	Panel with work lights
9HB 862 827-081	1	Panel with flasher lights and work lights
9HB 862 827-021	1	Panel with flasher lights

Bulb holder

For illumination of the middle panel.

For illumination of the sign surface are for OWS 10000 = 1 bulb holder, for OWS 1400/1600= 2 bulb holders necessary.



Part no.	Pk.	
9FT 861 790-001	1	Bulb holder with 12V bulb
9FT 861 790-011	1	Bulb holder with 24V bulb
Spare parts:		
8GP 003 594-121	1	W5W bulb, 12V
8GP 003 594-251	1	W5W bulb, 24V

Push-pull switch

With red warning light, without bulb.



Part no.	Pk.	
6ED 004 778-011	2	Push-pull switch
Spare parts:		
8GP 002 095-121	10	W5/1,2 bulb, 12V1,2W
8GP 002 095-241	10	W5/1,2 bulb, 24V1,2W

Rubber bases



Part no.	Pk.	
9GD 862 080-001	1	For OWS 1000. Rubber base for light curved roofs
9GD 862 081-001	1	For OWS 1400. Rubber base for curved roofs
9GD 862 085-001	1	For OWS 1600. Rubber base for curved roofs



Mounting system

Suitable for permanent mounting on trucks and cars.

Part no.	Pk.	
9XD 857 445-801	1	Fixing system set



Mounting set

For welding on to existing bracket.
Contents: 2 mounts and hardware.

Part no.	Pk.	
9XD 861 995-801	1	Mounting set



Bracket set



for direct mounting.

Part no.	Pk.	
9XD 861 990-001	1	Bracket set for OWS 1000
9XD 861 990-011	1	for OWS 1400
9XD 861 990-021	1	for OWS 1600

Optical Warning Systems OWS 4

Spare parts for old-type systems



	Optical warning system	Dome	1) Reflector 2) Drive belt 3) Contact ring			Bulb		
			Pk.		Pk.		Pk.	
	2RL 005 410-02 12V	9EL 857 576-021 amber	1	1) with drive belt 9DX 859 626-001	1	8GH 002 089-133 12V55W (H1)	1	
		9EL 856 989-001 white, can be printed as required (2 pieces)	1			2) 9XR 855 975-001 (2 pieces)	1	8GH 002 089-251 24V70W (H1)
		2RL 005 410-03 24V	9EL 857 576-031 amber	1	3) with brush 9MK 854 066-001	1	for illumination of the white panels 8GM 002 091-131 12V10W (K)	10
			9EL 856 989-001 white, can be printed as required (2 pieces)	1				
		2RL 005 410-00 12V	9EL 856 989-001 white, can be printed as required (2 pieces)	1				
		2RL 005 410-08 12V	9EL 857 576-021 amber	1				
	2RL 005 410-09 24V	9EL 857 576-031 amber	1					
	2RL 005 410-14 24V	9EL 857 576-031 amber	1	1) 9XR 855 975-001 (2 pieces)	1	8GH 002 089-251 24V70W (H1)	1	
				2) with brush 9MK 854 066-001	1			

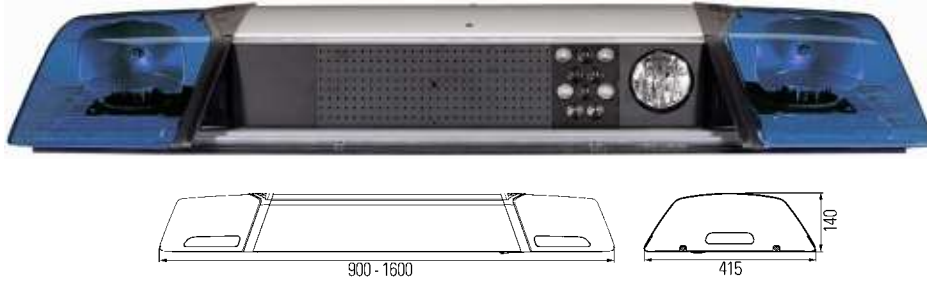

Rotating beacon and siren combinations RTK 7 with single reflector system KL-ER, 900 mm - 1600 mm

For police, fire brigade and ambulances.

With two blue PC domes and H1 bulbs.

Light aperture (reflector): 125 x 80 mm.

The RTK 7 fulfils all legal regulations for acoustic and optical warning devices in accordance with EMC Directives (72/245/EEC Directive state 2005/49/EC).

Due to modular design with length variance from 900 mm to 1600 mm at 100 mm intervals, the RTK 7 can be designed individually to meet the customer's requirements.

The overall system has a control concept which optionally enables conventional and analog signals and also modern data bus systems (CAN open in acc. w. CIA 447).

As an alternative to the separate loudspeaker systems, loudspeakers that can be integrated at the front and rear are also available.

The RTK 7 system is rounded off by an intelligent, programmable control unit with display and built-in microphone.

Technical data:

Operating voltage range: 9V < UBAT < 16V.

Quiescent current consumption: < 0,5 mA.

Undervoltage switch-off: < 9V - 0,5V.

Overvoltage switch-off: > 16V + 0,5V.

Current-carrying capacity: Control outputs < 0.3A, display outputs < 0.3A, light outputs < 0.5A to 7A.

Operating temperature: -40 °C bis +80 °C.

RF suppression: CISPR 25, class 3 (conducted).

Operation: Digital using handheld type HA 112 or HA 115.

Data bus protocol: CAN open in acc. w. CIA 447 / FireCAN.

Current consumption of the module equipment: KL-LM2 (2 levels day): 2.7A.

Power consumption: (2 levels day): 36W.

Configuration possibilities:

Light dome colours: blue, amber, red.

Loudspeaker: Integrated front, integrated rear, separate.

Long-range flash module BSF-LED.

Side-mounted light "Alley Light".

Front-work light: Halogen, LED.

Stop signal (ASG): LED.

Information module (congestion warning).

KL-A: Pre-equipped for plug-in beacon.

Part no.	Pk.	
2RM 010 700-...	1	Rotating beacon and siren combination RTK 7 with single reflector system KL-ER
		Spare parts:
		Dome, blue,
9EL 172 563-001	1	without cutout
9EL 172 563-101	1	with cutout
		Dome, amber,
9EL 172 563-221	1	without cutout
9EL 172 563-321	1	with cutout
8KA 178 692-801	1	Programming set

Rotating Beacon and Siren Combinations RTK 7

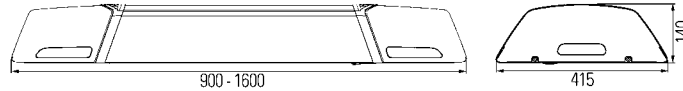

Flashing Beacon and Siren Combinations RTK 7 with LED trough module KL-LR2, 900 - 1600 mm

For police, fire brigade, rescue vehicles, ambulances.

With two clear PC domes and 2 x 2 reflectors with 24 blue LEDs each for blue light.

The RTK 7 fulfils all legal regulations for acoustic and optical warning devices in accordance with EMC Directives (72/245/EEC Directive state 2005/49/EC).

Due to modular design with a length range from 900 mm to a possible 1600 mm at 100 mm intervals, the RTK 7 can be designed individually to meet the customer's requirements.

The overall system has a control concept which optionally enables conventional and analog signals and also modern data bus systems (CAN open in acc. w. CIA 447).

As an alternative to the separate loudspeaker systems, loudspeakers that can be integrated at the front and rear are also available. The RTK 7 system is rounded off by an intelligent, programmable control unit with display and built-in microphone.

Technical data:

Operating voltage range: $9V < U_{BAT} < 16V$.

Quiescent current consumption: $< 0,5 \text{ mA}$.

Undervoltage switch-off: $< 9V - 0.5V$.

Overvoltage switch-off: $> 16V + 0.5V$.

Current-carrying capacity: Control outputs $< 0.3A$, display outputs $< 0.3A$, light outputs $< 0.5A$ to $7A$.

Operating temperature: $-40 \text{ }^\circ\text{C}$ bis $+80 \text{ }^\circ\text{C}$.

RF suppression: CISPR 25, class 3 (conducted).

Operation: Digital using handheld type HA 112 or HA 115.

Data bus protocol: CAN open in acc. w. CIA 447 / FireCAN .

Current consumption of the module equipment: KL-LM2 (2 levels day): $2.7A$.

Power consumption: (2 levels day): $36W$.

Configuration possibilities:

Light dome colours: blue, transparent.

Loudspeaker: Integrated front, integrated rear, separate.

Long-range flash module BSF-LED.

Side-mounted light Alley Light.

Front-work light: Halogen, LED.

Stop signal (ASG): LED.

Information module (congestion warning).

KL-A: Pre-equipped for plug-in beacon.

Part no.	Pk.	
2RM 010 700-...	1	Flashing Beacon and Siren Combination RTK 7 with LED trough module KL-LR2
2RM 010 701-...	1	Flashing Beacon and Siren Combination RTK 7 with LED trough module KL-LR2
		Spare parts:
		Dome, blue,
9EL 172 563-011	1	without cutout
9EL 172 563-111	1	with cutout
8KA 178 692-801	1	Programming set

Further versions with additional light modules on request

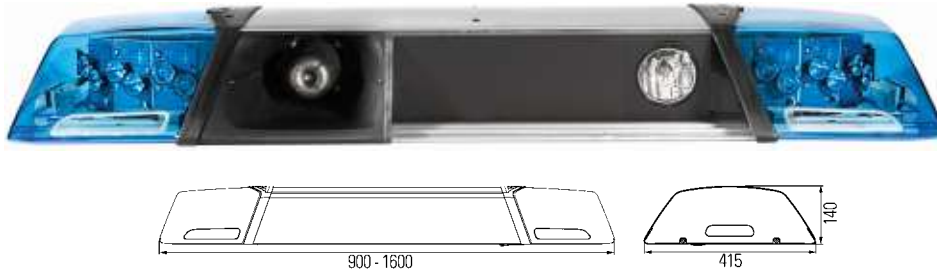

Rotating Beacon and Siren Combinations RTK 7 with LED 2-level module system KL-LM2 (day/night switching system) 900 mm - 1600 mm

For police, fire brigade and rescue vehicles.

With two blue PC domes and 16 high-performance LEDs in each case, with direct emission for longer flash at daylight.

The RTK 7 fulfils all legal regulations for acoustic and optical warning devices in accordance with EMC Directives (72/245/EEC Directive state 2005/49/EC) and ECE approval for day/night switching system.

Due to modular design with a length range from 900 mm to a possible 1600 mm at 100 mm intervals, the RTK 7 can be designed individually to meet the customer's requirements.

The overall system has a control concept which optionally enables conventional and analog signals and also modern data bus systems (CAN open in acc. w. CIA 447).

As an alternative to the separate loudspeaker systems, loudspeakers that can be integrated at the front and rear are also available. The RTK 7 system is rounded off by an intelligent, programmable control unit with display and built-in microphone.

Technical data:

Operating voltage range: $9V < U_{BAT} < 16V$.

Quiescent current consumption: $< 0,5 \text{ mA}$.

Undervoltage switch-off: $< 9V - 0.5V$.

Overvoltage switch-off: $> 16V + 0.5V$.

Current-carrying capacity: Control outputs $< 0.3A$, display outputs $< 0.3A$, light outputs $< 0.5A$ to $7A$.

Operating temperature: $-40 \text{ }^\circ\text{C}$ bis $+80 \text{ }^\circ\text{C}$.

RF suppression: CISPR 25, class 3 (conducted).

Operation: Digital using handheld type HA 112 or HA 115.

Data bus protocol: CAN open in acc. w. CIA 447 / FireCAN .

Current consumption of the module equipment: KL-LM2 (2 levels day): $2.7A$.

Power consumption: (2 levels day): $36W$.

Configuration possibilities:

Light dome colours: blue, transparent.

Loudspeaker: Integrated front, integrated rear, separate.

Long-range flash module BSF-LED.

Side-mounted light Alley Light.

Front-work light: Halogen, LED.

Stop signal (ASG): LED.

Information module (congestion warning).

KL-A: Pre-equipped for plug-in beacon.

Part no.	Pk.	
2RM 010 701-...	1	Flashing Beacon and Siren Combinations RTK 7 with LED 2-level module system KL-LM2
		Spare parts:
9EL 172 563-011	1	Dome, blue, without cutout
9EL 172 563-111	1	with cutout
8KA 178 692-801	1	Programming set

Rotating beacon and siren combinations RTK-QS

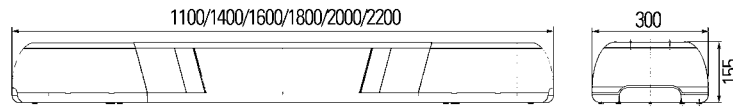

Part no.	Pk.	
2RM 379 500-...		Rotating beacon and siren combinations RTK-QS, only accessories and spare parts available
2RM 379 501-...		Rotating beacon and siren combinations RTK-QS, only accessories and spare parts available
		Spare parts:
9EL 863 117-011	1	Dome blue (KL-ER, KL-MR)
		Rotating mirror module (KL-ER),
2RL 863 132-001	1	12V
2RL 863 132-011	1	24V
9XR 855 975-001	1	Drive belts (2 pieces), KL-ER
		H1 bulb (KL-ER, KL-MR),
8GH 002 089-133	1	12V55W
8GH 002 089-251	1	24V70W
9EL 863 117-001	1	Dome blue (KL-XL2)
		Double flashing module (KL-XL2),
2RL 863 106-001	1	12V
2RL 863 106-011	1	24V
8GS 859 634-001	1	Xenon tube (KL-XL2)
9EL 863 117-001	1	Dome blue (KL-XR2)
		Flashing module (KL-XR2),
2RL 863 123-001	1	12V
2RL 863 123-011	1	24V
8GS 863 889-001	1	Xenon tube (KL-XR2)
		Dome (KL-LR2),
9EL 863 117-131	1	blue
9EL 863 117-151	1	clear
2RL 171 067-101	1	LED module, blue, 12V/24V, (KL-LR2)
		Control unit light and acoustic ZSE L/A,
5XA 008 877-001	1	12V
5XA 008 877-011	1	24V
		Control unit light ZSE L,
5XA 863 115-001	1	12V
5XA 863 115-011	1	24V
		Loudspeaker,
9MM 863 165-001	1	front
1GA 008 284-101	1	Side-mounted light Alley Light
		Lead set
8KB 863 243-001	1	for main beacons, 1050 mm
8KB 863 120-011	1	incl. possibility for public address (NF)



Control units

eAZD control unit with programmable keys with function, indicator and background illumination for control of optical and acoustic signals from RTK-QS.
With 2 m lead.

Part no.	Pk.	
9SX 008 902-001	1	eAZD control unit, 12 / 24V
8HG 863 383-001	1	Accessories: Installation frame (DIN) shaft for installation of eAZD and eNF, delivered with eNF blind cover



eNF switching unit for control of communication functions: radio switch on (for standardised and non-standardised two-way radios), Microphone switch (up to 2 microphones), CD player connection, multiple stage volume control, function illumination, background illumination.
Contents: Control unit, operating panel and 2 m connection lead.

Technical data:

Rated voltage: 12V / 24V.
Supply voltage: 9V - 32V.
Power consumption: max. 500 mA.
NF level
Microphone 1: USS up to 4 mV / 450 mV,
Microphone 2: USS up to 4 mV / 450 mV,
Radio: USS to 800 mV, Recorder: 2000 mV.
RF suppression: CISPR 25, class 5 (conducted).
Operating temperature: -40 °C to +90 °C.
Type of protection: dustproof.

Part no.	Pk.	
9SX 863 114-001	1	Can be used separately or in combination with eAZD control unit.
8HG 863 383-001	1	Accessories: Installation frame (DIN) shaft for installation of eAZD and eNF, delivered with eNF blind cover



Programming sets and cables

Part no.	Pk.	
5XA 863 850-801	1	Programming set consisting of: 1xUSB/CAN adapter, 1 x cable 4 m, 1 x software CD
8KB 863 120-011	1	Device lead for the possibility of public address NF
8KB 863 243-001	1	Lead for main beacons
8KB 863 116-001	1	Connection line for 3rd KL
8KB 863 322-001	1	eNF cable for handset, 1 m
8KB 863 322-011	1	3 m
8KB 863 323-001	1	eNF cable for FuG 7/8, 1 m
8KB 863 323-011	1	3 m
8KB 863 325-001	1	eNF cable for Teldux FuG 9, 1,5 m
8KB 863 324-001	1	for microphone, 1 m
8KB 863 119-001	1	Standard vehicle wiring harness, 4 m
8KB 863 119-011	1	incl. pre-equipped public address system (NF), 4 m
8KB 863 119-031	1	incl. light/acoustic module (ZSE L), 4 m
8KB 863 119-041	1	incl. pre-equipped public address system (NF) and light acoustic module (ZSE L), 4 m



Microphone

With on/off switch, 0,5 m spirally cable, holder, Plug and volume control.



Part no.	Pk.	
9MM 862 358-801	1	Hand-held microphone
8HG 854 516-001	1	Spare parts/Accessories: Bracket
8KB 862 689-001	1	Adapter lead, 1 m
9MK 860 255-001	1	Device socket

With holder and 0,5 m lead.



Part no.	Pk.	
9MM 859 358-801	1	Hand-held microphone
8KB 862 689-001	1	Accessories: Adapter lead, 1 m
9MK 860 255-001	1	Device socket

Rubber bases



Part no.	Pk.	
		For 1100 mm systems.
9GD 864 285-001	1	Rubber spacer, flat
9GD 864 286-001	1	Rubber base, wedge-shaped
		For 1400 mm systems.
9GD 864 286-011	1	Rubber base, wedge-shaped
		For 1600 mm systems.
9GD 864 286-021	1	Rubber base, wedge-shaped
9GD 863 122-001	1	Installation kit

Bracket

Part no.	Pk.	
9XD 176 641-801	1	Bracket set for VW T5

Panels

Part no.	Pk.	
9AB 864 273-001	1	Panel , black with white lettering: 'FEUERWEHR'
9AB 864 273-011	1	with white lettering: 'NOTARZT'

Sound Warning System RTK-VE 7

For concealed installation in cars, trucks and motorcycles.
 For police, rescue and fire brigade.
 The unit can easily be combined with all Hella KL, KLX and OWS.

Contents:

- 1 control unit 12V ZSE-VE 7
- 1 mounting kit and installation instructions

Technical data - control unit ZSE-VE 7:

Rated voltage: 12V.
 Operating voltage: 9V - 16V.
 Operating temperature: -40 °C to +80 °C.
 RF suppression: VDE 0879 part 3, CISPR 25, class 3 (conducted).
 Frequency, city signal: 410Hz low, 547Hz high.
 Frequency, country signal: 362Hz low, 483Hz high.
 Other frequencies are programmed for specific countries.
 Control of the tone sequence and rotating beacons is accomplished over separate individual switches or alarm pull/rotary switches.
 Type of protection loudspeaker: resistant to high pressure cleaning.
 Type of protection ZSE-VE7: dustproof and splash-waterproof with heightened pressure.



Part no.	Pk.	
3SL 009 678-801	1	Signal-warning set, 12V
8KB 175 501-001	1	Vehicle wiring harness 2 LK for connecting the RTK-VE 7 to the vehicle electrics
9MM 863 164-051	1	Accessories: Loudspeaker with AMP-Superseal plug connector (2 off required)
9MM 010 657-001	1	Licence plate loudspeaker with AMP-Superseal plug connector (1 off required)

Control units

eAZD control unit with programmable keys with function, indicator and background illumination for control of optical and acoustic signals.
 With 300 mm lead.

Part no.	Pk.	
9SX 008 902-021	1	eAZD control unit, 12V / 24V
8HG 863 383-001	1	Accessories: Installation frame (DIN) shaft for installation of eAZD and eNF, delivered with eNF blind cover
8KB 864 105-801	1	Extension cable set Contents: 2 cables, each 3.5 m long

Control units

eNF switching unit for control of communication functions:
radio switch on (for standardised and non-standardised two-way radios).

**Microphone switch (up to 2 microphones),
CD player connection, multiple stage volume control,
function illumination, background illumination.**

Contents: Control unit, operating panel and 2 m connection lead.

Technical data:

Rated voltage: 12V / 24V.

Supply voltage: 9V - 32V.

Power consumption: max. 500 mA.

NF level

Microphone 1: USS up to 4 mV / 450 mV,

Microphone 2: USS up to 4 mV / 450 mV,

Radio: USS to 800 mV, Recorder: 2000 mV.

RF suppression: CISPR 25, class 5 (conducted).

Operating temperature: -40 °C to +90 °C.

Type of protection: dustproof.



Part no.	Pk.	
		Can be used separately or in combination with eAZD control unit.
9SX 863 114-001	1	eNF switching unit, 12V / 24V
		Accessories: Installation frame (DIN) shaft for installation of eAZD and eNF, delivered with eNF blind cover
8HG 863 383-001	1	

Push-pull-rotary alarm switches



Part no.	Pk.	
		3 switch positions: 0 = off, left = flashing (rotating) beacon on, successive-tone signal ready for operation, pulled out = rotating beacon on, operating of successive-tone signal.
6ZE 001 759-071	1	Alarm switch with pre-fitted 12V bulb and spare 24V bulb
		With 4 switch positions: 0 = off, right = flashing (rotating) beacon on, normal horn ready for operation, left = flashing (rotating) beacon on, successive-tone signal ready for operation, pulled out = rotating beacon on, operating of successive-tone signal.
6ZE 001 759-051	1	Alarm switch with pre-fitted 12V bulb
		Spare parts:
9SG 703 965-007	1	Knob
8GP 002 095-121	10	W5/1,2 bulb,
8GP 002 095-241	10	12V1,2W
		24V1,2W

Sound Warning System RTK-VE

For concealed installation in cars, trucks and motorcycles.
 For police, rescue and fire brigade.
 The unit can easily be combined with all Hella KL, KLX and OWS.

Contents:

- 1 control unit 12V ZSE-VE
- 1 mounting kit and installation instructions

Technical data - control unit ZSE-VE:

Rated voltage: 12V.
 Operating voltage: 9V - 16V.
 Operating temperature: -40 °C to +85 °C.
 RF suppression: CISPR 25, class 5 (conducted).
 Total power consumption: max. 20A.
 Acoustic pressure level: >/- 112 dB at distance of 3.5 m.
 Frequency, city signal: 410Hz low, 547Hz high.
 Frequency, country signal: 362Hz low, 483Hz high.
 Other frequencies are programmed for specific countries.
 Control of the tone sequence and rotating beacons is accomplished over separate individual switches or alarm pull/rotary switches.
 Type of protection loudspeaker:
 resistant to high pressure cleaning.
 Type of protection ZSE-VE: dustproof and splash-waterproof with heightened pressure.



Part no.	Pk.	
3SL 008 604-821	1	Signal-warning set, 12V
		Accessories:
		Loudspeaker cable, (1 cable required per loudspeaker)
8KB 863 514-001	1	6 m, unshielded, for self-assembly
8KB 862 346-001	1	2 m, shielded, pre-assembled
8KB 862 346-011	1	4 m, shielded, pre-assembled
9XB 167 882-001	1	Cable adapter for 8KB 862 346-001/-011

Control units

eAZD control unit with programmable keys with function, indicator and background illumination for control of optical and acoustic signals.
 With 300 mm lead.



Part no.	Pk.	
9SX 008 902-021	1	eAZD control unit, 12 / 24V
		Accessories:
		Installation frame (DIN) shaft for installation of eAZD and eNF, delivered with eNF blind cover
8HG 863 383-001	1	
		Extension cable set
8KB 864 105-801	1	Contents: 2 cables, each 3.5 m long

Control units

eNF switching unit for control of communication functions:
radio switch on (for standardised and non-standardised two-way radios).

**Microphone switch (up to 2 microphones),
CD player connection, multiple stage volume control,
function illumination, background illumination.**

Contents: Control unit, operating panel and 2 m connection lead.

Technical data:

Rated voltage: 12V / 24V.

Supply voltage: 9V - 32V.

Power consumption: max. 500 mA.

NF level

Microphone 1: USS up to 4 mV / 450 mV,

Microphone 2: USS up to 4 mV / 450 mV,

Radio: USS to 800 mV, Recorder: 2000 mV.

RF suppression: CISPR 25, class 5 (conducted).

Operating temperature: -40 °C to +90 °C.

Type of protection: dustproof.



Part no.	Pk.	
		Can be used separately or in combination with eAZD control unit.
9SX 863 114-001	1	eNF switching unit, 12V / 24V
		Accessories: Installation frame (DIN) shaft for installation of eAZD and eNF, delivered with eNF blind cover
8HG 863 383-001	1	

Push-pull-rotary alarm switches



Part no.	Pk.	
		3 switch positions: 0 = off, left = flashing (rotating) beacon on, successive-tone signal ready for operation, pulled out = rotating beacon on, operating of successive-tone signal.
6ZE 001 759-071	1	Alarm switch with pre-fitted 12V bulb and spare 24V bulb
		With 4 switch positions: 0 = off, right = flashing (rotating) beacon on, normal horn ready for operation, left = flashing (rotating) beacon on, successive-tone signal ready for operation, pulled out = rotating beacon on, operating of successive-tone signal.
6ZE 001 759-051	1	Alarm switch with pre-fitted 12V bulb
		Spare parts:
9SG 703 965-007	1	Knob
8GP 002 095-121	10	W5/1,2 bulb, 12V1,2W
8GP 002 095-241	10	24V1,2W

Microphone

With on/off switch, 0,5 m spirally cable, holder, Plug and volume control.



Part no.	Pk.	
9MM 862 358-801	1	Hand-held microphone
Spare parts/Accessories:		
8HG 854 516-001	1	Bracket
8KB 862 689-001	1	Adapter lead, 1 m
9MK 860 255-001	1	Device socket

With holder and 0,5 m lead.



Part no.	Pk.	
9MM 859 358-801	1	Hand-held microphone
Accessories:		
8KB 862 689-001	1	Adapter lead, 1 m
9MK 860 255-001	1	Device socket

Supertone horn-set

B 133

For basic requirements.

Sound pressure level 2 m away: 118 dB(A).

Power consumption per horn: 78W at 12V, 84W at 24V.

According to DIN 14 610.

Black metal body, with blade terminal contacts,

Gummitülle für Berührungsschutz.

Bracket on horn for M10 fixing screw.

Teflon seal protects against damp.

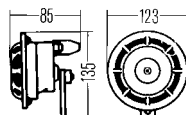
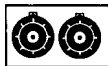

Part no.	Pk.	
Comprises:		
2 supertone horns		
3AG 003 399-081	1	Supertone horn-set, 375/500 Hz
3AG 003 399-101	1	Supertone horn-set, 24V, 375/500 Hz
Supertone horn,		
3AF 003 399-041	1	12V, 375 Hz
3AF 003 399-051	1	12V, 500 Hz
3AF 003 399-061	1	24V, 375 Hz
3AF 003 399-071	1	24V, 500 Hz

Tone sequence control modules



Part no.	Pk.	
5AB 005 944-001	1	Tone sequence control module, 12V
5AB 005 944-011	1	24V

Rotating beacons with halogen H1 light

KL 5000 M

According to DIN 14 620, shape B1, n = 160 U/min.
With built-in 12V bulb. Light aperture (reflector dia.): 76 mm.

Black base.

With magnetic attachment, spirally-coiled lead extends up to 2.5 m and 2-pole plug for connecting to the cigarette lighter socket or boardsocket to DIN-ISO 4165.

Total power consumption: 12V55W = 4.5A.

Operating temperature: -40 °C to +60 °C.

RF suppression: CISPR 25, class 5 (conducted).

Resistant to high pressure cleaning.

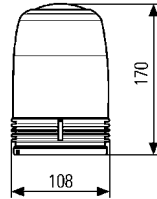

Part no.	Pk.	
2RL 008 364-021	1	Rotating beacon, blue, 12V
Spare parts/Accessories:		
9EL 862 267-031	1	Dome
9XR 854 840-001	1	Drive belts (2 pieces)
8JB 004 777-002	1	Boardsocket, 2-pole
8JB 004 777-001	5	
8GH 002 089-133	1	H1-bulb, 12V55W

Electronic flashing beacons

KLX 5000 M

With magnetic attachment, integrated power supply and built-in xenon tube (gas discharge bulb).

Light aperture: 80 mm dia.

Shielding basket over xenon bulb reduces high-frequency interference radiation and ensures good radio reception.

Power consumption: 3A. Electrical strobe power: 10 + 2 Ws.

Strobe frequency: 2.1 Hz = approx. 120 double flashes/min.

Operating temperature: -40 °C to +60 °C.

RF suppression: CISPR 25, class 5 (conducted).

Resistant to high pressure cleaning.

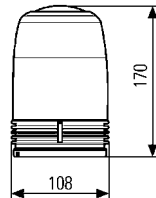

Part no.	Pk.	
2RL 008 366-021	1	Flashing beacon, blue, 12V, with spirally-coiled lead and 2-pole plug for connecting to the cigarette lighter socket
2RL 008 366-031	1	with spirally-coiled lead and Lemo plug
Spare parts/Accessories:		
9EL 862 267-001	1	PC-dome with lens
8GS 859 634-001	1	Xenon tube
8JB 008 839-001	1	Lemo socket for -031



2-pole socket

According to DIN EN ISO 4165. Max. load: 8A at 12V.
With cover and two blade terminal contacts 6.3 mm.

Part no.	Pk.	
8JB 004 777-001	5	2-pole socket

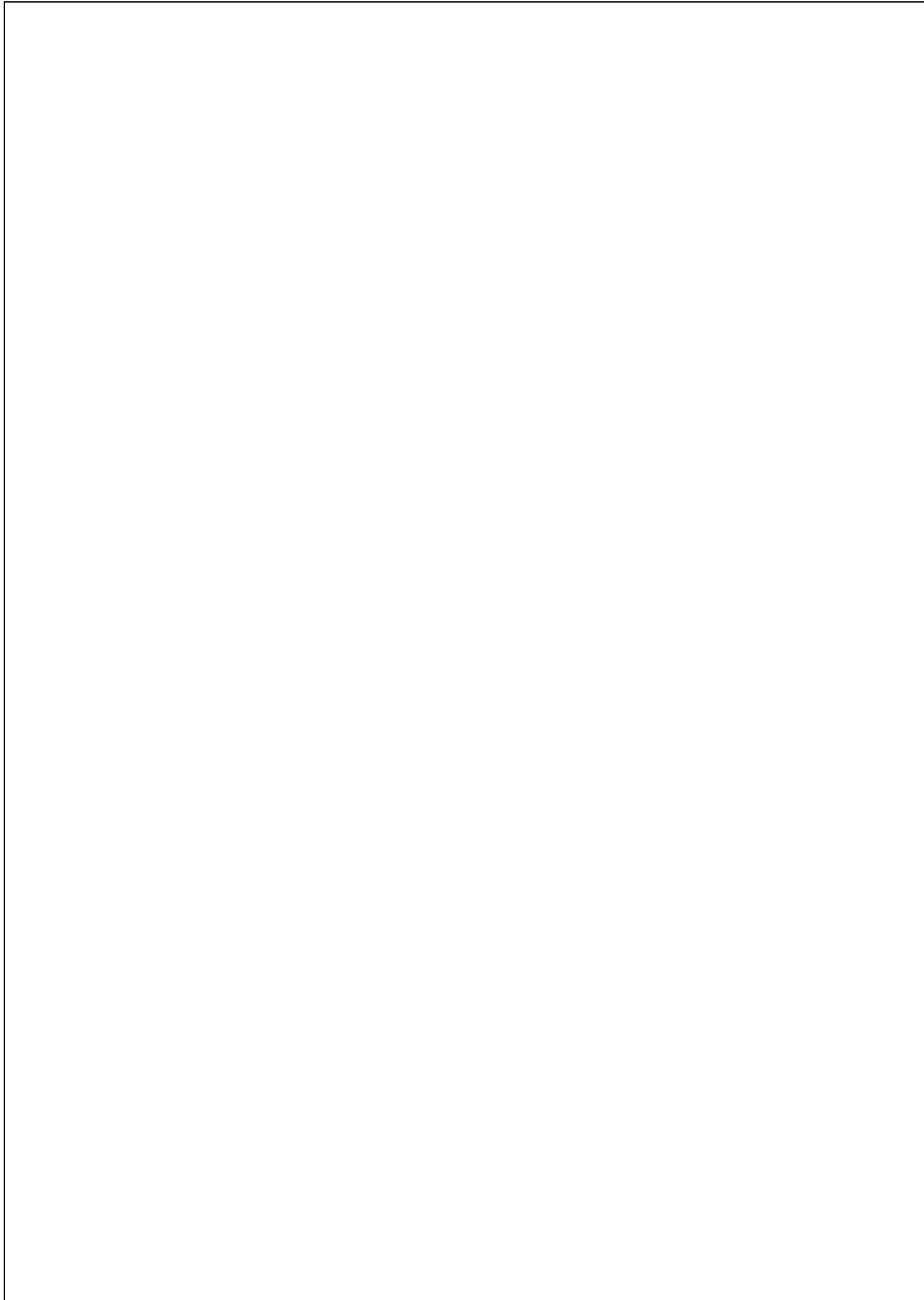



SEG IV C, spare parts and accessories

7.02

SEG IV DLX, DL, D, spare parts and accessories

7.03

SEG IV AL, A, spare parts and accessories

7.04-7.05

SEG-Economy D and spare parts

7.05

Spare parts for SEG III

7.06



Beamsetters for testing all types of headlight systems SEG IV C

The beamsetter is microprocessor-controlled. The headlight settings are checked and evaluated with the aid of a camera. The settings are made on the device using the operating panel with LCD display, where the light values of the headlights are also shown. An optical and acoustic setting mode makes adjustment at the vehicle headlight easier. longitudinal axis is by means of a laser sight. Headlights installed at heights between 250 mm and 1450 mm

Part no.	Pk.	
		SEG IV C
		Contents:
8PA 007 732-123	1	beamsetter box, laser sight and wheel-mounted base
8XT 861 234-023	1	Column, 1.4 m long (to be ordered separately)
		Spare parts:
8PV 861 112-011	1	Laser sight
9EV 861 038-001	1	Window for console
9ST 861 074-001	1	Button
9SG 855 498-001	1	Handwheel for sight holder
9SG 855 454-011	5	Handwheel for fixing the column in place
8XT 861 234-023	1	Column with locking mechanism
9XD 857 744-001	1	Clamp for column
9XS 862 004-001	1	Set of wheels (3 pieces)
		Further spare parts are available. Replacement requires re-adjustment of the beamsetter. This is carried out by a specially equipped Hella agency or wholesaler.

Beamsetters for testing all types of headlights systems SEG IV D / DL / DLX / DLXL

With digital luxmeter.

The laser positioning aid makes precise alignment of the beamsetter box to the headlight possible.

This means that bulbs can be sighted directly, particularly for free-form headlights.

Eccentric axle and spirit level to compensate uneven surfaces.

With a deflection mirror to enable the test monitor to be seen from behind.



Part no.	Pk.	
8PA 007 732-223	1	SEG IV DLX Contents: beamsetter box, broad-band sight and wheel-mounted base
8PA 007 732-233	1	SEG IV DLXL Contents: beamsetter box, laser sight and wheel-mounted base
8XT 861 234-023	1	Column, 1.2 m long (to be ordered separately)
8PA 007 732-213	1	Same as SEG IV DLX, but without eccentric axle and spirit level SEG IV DL Contents: beamsetter box, broad-band sight and wheel-mounted base
8XT 861 234-023	1	Column, 1.2 m long (to be ordered separately)
8PA 007 732-203	1	Same as SEG IV DLX, but without eccentric axle, spirit level and laser positioning aid SEG IV D Contents: beamsetter box, broad-band sight and
8XT 861 234-023	1	Column, 1.2 m long (to be ordered separately)
8PL 863 005-001	1	Spare parts/Accessories: Luxmeter
9ST 863 241-001	1	Switch for luxmeter
9EV 861 038-001	1	Window for console
9ST 861 074-001	1	Button
8PV 861 112-021	1	Broad-band sight without holder
9SG 855 498-001	1	Handwheel for sight holder
9SG 855 454-011	5	Handwheel for fixing the column in place
9XD 857 744-001	1	Clamp for column
9XS 862 004-001	1	Set of wheels (3 pieces)
9XS 861 127-051	1	Red cover, with deflection mirror and attachment material
8PV 861 112-011	1	Laser sight
		Further spare parts are available. Replacement requires re-adjustment of the beamsetter. This is carried out by a specially equipped Hella agency or wholesaler.

Beamsetters SEG IV A / AL

With analogue display and deflection mirror to enable the test monitor to be seen from behind. The laser positioning aid makes precise alignment of the beamsetter box to the headlight possible. This means that bulbs can be sighted directly, particularly for free-form headlights.

Part no.	Pk.	
8PA 007 732-003	1	SEG IV AL Contents: beamsetter box, broad-band sight and wheel-mounted base
8XT 861 234-003	1	Column, 1.2 m long (to be ordered separately)
8PA 007 732-013	1	Same as SEG IV AL, but without laser positioning aid SEG IV A Contents: beamsetter box, broad-band sight and wheel-mounted base
8XT 861 234-003	1	Column, 1.2 m long (to be ordered separately)
8PL 861 660-001		Spare parts/Accessories: Lux-/Voltmeter
9EV 861 038-001	1	Window for console
9ST 861 074-001	1	Button
8PV 861 112-021	1	Broad-band sight without holder
9SG 855 498-001	1	Handwheel for sight holder
9SG 855 454-011	5	Handwheel for fixing the column in place
9XD 857 744-001	1	Clamp for column
9XS 862 004-001	1	Set of wheels (3 pieces)
9XS 861 127-051	1	Red cover, with deflection mirror and attachment material
8PV 861 112-011	1	Laser sight
		Further spare parts are available. Replacement requires re-adjustment of the beamsetter. This is carried out by a specially equipped Hella agency or wholesaler.



Accessories:

Adjusting device for all SEG's.

Part no.	Pk.	
8PD 860 755-001	1	Adjusting device

Accessories:

Rail kit for SEG IV

For workshops with a large vehicle volume, it makes sense to mount the beamsetter on rails. The recommended rail length is min. 3 m.

Part no.	Pk.	
9XS 861 736-001	1	Rail kit, 1,5 m with fixing materials

Accessories:

Protective hood

Protects beamsetter from dust, dirt and moisture when not in use.

Part no.	Pk.	
8XS 002 500-011	1	Protective hood

Beamsetters Economy

With wheel-mounted base, broad-band sight and luxmeter.



Part no.	Pk.	
8PA 006 796-031	1	SEG-Economy D with digital display and red beamsetter box
8PA 006 796-051	1	and blue beamsetter box
8PA 006 796-041	1	with silver beamsetter box and sight and base painted in an anthracite colour
9EV 859 051-011	1	Spare parts: Window for console ->04/06 Further spare parts are available. Replacement requires re-adjustment of the beamsetter. This is carried out by a specially equipped Hella agency or wholesaler.

Spare parts SEG III (old-type)

*) Replacement of these spare parts requires re-adjustment of the beamsetter.

This is carried out by a specially equipped Hella agency or wholesaler.

Part no.	Pk.	
9SG 855 454-011	5	Handwheel for fixing the column in place
9XD 857 744-001	1	Clamp for column
8PV 855 390-001	1	Broad-band sight *)
9SG 855 498-001	1	Handwheel for sight holder
9ST 855 447-001	1	Button for beamsetter box brake
9XD 857 579-001	10	Clamp for beamsetter box brake
9XS 857 585-001	10	Clamp with axle for beamsetter box brake
9EL 857 597-001	1	Fresnel lens *)
9EV 857 067-011	1	Protective glass cover for fresnel lens *)
9XS 857 588-001	1	Column guide *)
9XS 854 769-001	1	Set of wheels for wheel-mounted base
9XS 855 646-001	1	Set of wheels for rail-mounted base



Bulb overview	8.02
Bulb sets	8.03-8.05
Assortments of bulbs for garages	8.06
Bulbs for headlights	8.06-8.12
Bulbs for signal lights	8.12-8.16
Bulbs with glass sockets	8.12, 8.15-8.16
Bulbs with plastic caps for dashboard and interior lighting	8.17-8.20
Bulb holders	8.20
Connectors	8.20-8.21
Explanations	
+ 30 / + 50 / + 90	= more light. Better detection of hazards and obstacles
Blue Light	= Xenon-look bulbs
Yellow Light	= Lower subjective self-glare in rain, snow and fog
Double Power	= Service life increased by up to 100%. For commercial vehicles
Heavy Duty	= Particularly resistant to blows and vibrations
Long Life	= Service life increased by up to 100%

Bulb overview for Cars and Trucks

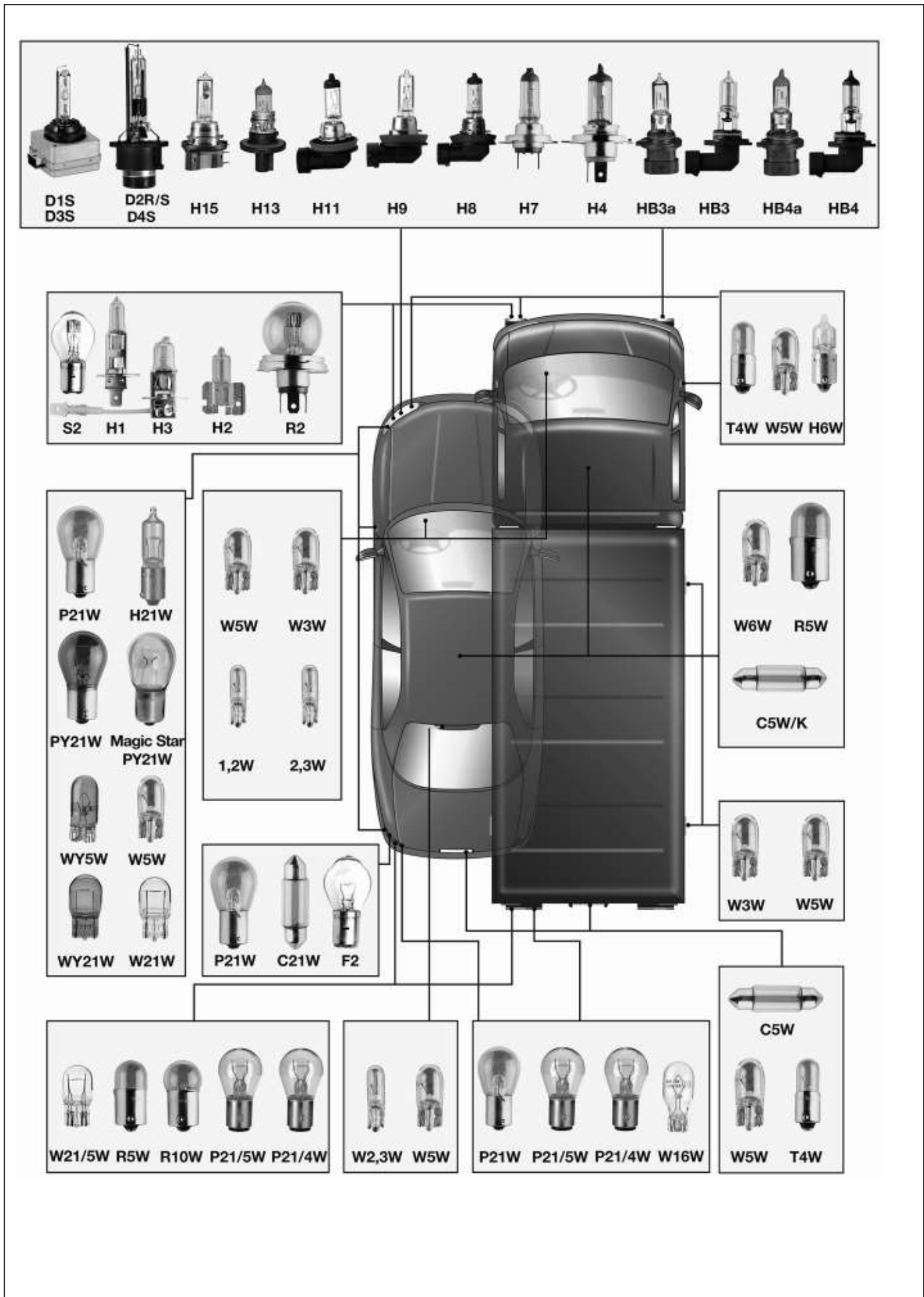

H7 bulb sets



Part no.	Pk.	Contains:
8GH 007 157-901	1	<p>Contains: 1 each of 12V55W (H7) 12V21/5W (P21/5W) 12V21/4W (P21/4W) 12V21W (P21W) 12V21W (PY21W) 12V5W (R5W) 12V5W (W5W) Blade-type fuses 10A, 15A, 30A</p> <p>H7 bulb set, 12V</p>
8GH 007 157-913	1	<p>Contains: 1 each of 12V55W (H7) 12V21/5W (P21/5W) 12V21W (P21W) 12V5W (R5W) 12V5W (W5W) 12V5W (C5W) Blade-type fuses 10A, 15A and 30A</p> <p>H7 bulb set, 12V</p>
8GH 007 157-941	1	<p>Contains: 1 each of 12V55W (H7) 12V21W (P21W) 12V5W (R5W) 12V4W (T4W) Blade-type fuses 10A, 15A and 30A</p> <p>H7 Mini bulb set, 12V</p>
8GH 007 157-931	1	<p>Contains: 2 each of 24V70W (H7) 24V21/5W (P21/5W) 24V21W (P21W) 24V10W (R10W) 24V5W (W5W) 24V5W (C5W) 2 each of blade-type fuses 10A, 15A and 30A</p> <p>H7 bulb set, 24V</p>

H7/HB3 bulb sets



Part no.	Pk.	Contains:
		1 each of 12V55W (H7) 12V60W (HB3) 12V21/5W (P21/5W) 12V21W (P21W) 12V21W (PY21W) Blade-type fuses 10A, 15A and 30A
8GH 007 157-921	1	H7/HB3 bulb set, 12V

H7/H1 bulb sets



Part no.	Pk.	Contains:
		1 each of 12V55W (H7) 12V55W (H1) 12V21W (P21W) 12V21W (PY21W) 12V5W (R5W) 12V5W (W5W) 12V5W (C5W) Blade-type fuses 10A, 15A and 30A
8GH 007 157-951	1	H7/H1 bulb set, 12V

H4 bulb sets



Part no.	Pk.	Contains:
8GJ 002 525-913	1	Contains: 1 each of 12V60/55W (H4) 12V21/5W (P21/5W) 12V21W (P21W) 12V5W (R5W) 12V4W (T4W) Blade-type fuses 10A, 15A and 30A H4 bulb set, 12V
8GJ 002 525-971	1	Contains: 1 each of 12V60/55W (H4) 12V21W (P21W) 12V5W (R5W) 24V4W (T4W) Blade-type fuses 10A, 15A and 30A H4 Mini bulb set, 12V
8GJ 002 525-941	1	Contains: 2 each of 24V75/70W (H4) 24V21/5W (P21/5W) 24V21W (P21W) 24V10W (R10W) 24V5W (C5W) 24V4W (T4W) Blade-type fuses 10A, 15A and 30A H4 bulb set, 24V

H1 bulb sets



Part no.	Pk.	Contains:
8GH 002 089-921	1	Contains: 1 each of 12V55W (H1) 12V21/5W (P21/5W) 12V21W (P21W) 12V5W (R5W) 12V5W (C5W) 12V4W (T4W) Blade-type fuses 10A, 15A and 30A H1 bulb set, 12V
8GH 002 089-941	1	Contains: 1 each of 12V55W (H1) 12V21W (P21W) 12V5W (R5W) 12V4W (T4W) Blade-type fuses 10A, 15A and 30A H1 Mini bulb set, 12V

Assortments of bulbs for garages

For cockpit-dashboards and interior lighting



Part no.	Pk.	Contents:
8GA 007 997-901	1	Contents: 10 each of 8GA 007 997-101, B 10d, 12V3W 8GA 007 997-111, B 10d, 12V5W 8GA 007 997-121, BX 8.4d, 12V1.2W 8GA 007 997-041, B 8.3d, 12V1.2W 8GA 007 997-001, B 8.3d, 12V2W 8GA 007 997-141, BX 8.4d, 12V1.5W 8GA 007 997-031, B 8.5d, 12V1.2W 8GA 007 997-081, B 8.5d, 12V2W 8GA 007 997-051, BX 8.7d, 12V1.2W 8GA 007 997-091, BX 8.7d, 12V2W
		Assortment of bulbs for garages 1, 12V
8GA 007 997-911	1	Contains: 10 each of 8GA 007 997-131, BX 8.4d, 12V1.3W 8GS 006 677-121, BX 8.5d, 12V2W 8GA 007 997-171, BX 8.4d, 12V1.2W 8GA 007 997-151, BX 8.5d, 12V0.36W 8GA 007 997-161, B 8.5d, 12V1.5W 8GA 007 997-211, BX 8.5d, 12V1.2W 8GA 007 997-221, BX 8.5d, 12V2W 8GA 007 997-231, BG 8.5 - 5.5d, 12V1.2W 8GA 007 997-241, BG 8 - 5.5d, 12V1.2W 8GA 007 997-251, B 8.5 S - 4d, 12V1.2W
		Assortment of bulbs for garages 2, 12V
8GA 007 997-921	1	Contains: 10 each of 8GP 002 095-241, W 2x4.6d, 24V1.2W (W5/1.2) 8GA 007 997-181, W 2x4.6d, 24V2W 8GP 003 594-241, W 2.1x9.5d, 24V3W (W3W) 8GA 008 901-241, W 2.1x9.5d, 24V2W 8GP 003 594-251, W 2.1x9.5d, 24V5W (W5W) 8GA 007 997-061, B 8.3d, 24V1.2W 8GA 007 997-071, B 8.5d, 24V1.2W 8GA 007 997-261, BX 8.5d, 24V1.2W 8GA 007 997-191, EBS R4, 24V1.2W 8GA 007 997-201, EBS R6, 24V1.2W
		Assortment of bulbs for garages 3, 24V



Gas discharge bulbs for headlights

Gas discharge bulb for headlights, driving lights and work lights

Part no.	Pk.	Contents:
8GS 009 028-021	1	D1S, bulb cap PK 32 d-2, 12/24V35W



Gas discharge bulbs for headlights

Gas discharge bulb for headlights and driving lights

Part no.	Pk.	
8GS 009 028-201	1	D1S, bulb cap PK 32 d-2, 12/24V35W



Gas discharge bulb for headlights, driving lights and work lights

Part no.	Pk.	
8GS 007 949-101	1	D2S, bulb cap P 32 d-2, 12/24V35W

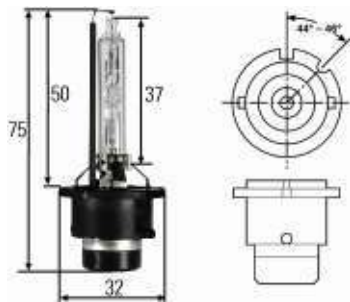

Gas discharge bulb for headlights, driving lights and work lights

Part no.	Pk.	
8GS 007 949-301	1	D4S, bulb cap P 32 d-5, 12/24V35W

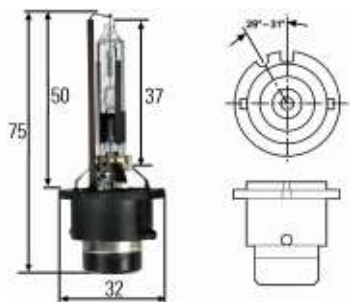

Gas discharge bulb for headlights

Part no.	Pk.	
8GS 007 001-121	1	D2R, bulb cap P 32 d-3, 12/24V35W

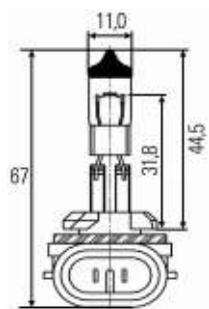

Bulbs for headlights

For Headlights with cornering, indicator and position light

Part no.	Pk.	
8GH 008 991-021	1	H27W/1, ECE-R 37, bulb cap PG 13, 12V27W
8GH 008 991-031	1	H27W/2, ECE-R 37, bulb cap PGJ 13, 12V27W

Bulbs for headlights

For H15 headlights

Part no.	Pk.	
8GJ 168 119-001	1	H15, ECE-R 37, bulb cap PGJ 236t-1, 12V15/55W

For H13 headlights (2-headlight system)

Part no.	Pk.	
8GJ 008 837-121	1	H13, ECE-R 37, bulb cap P 26.4T, 12V60/55W

For H11 headlights

Part no.	Pk.	
8GH 008 358-121	1	H11, ECE-R 37, bulb cap PGJ 19-2, 12V55W
8GH 008 358-151	1	12V55W + 30, in pairs only
8GH 008 358-181	1	12V55W Blue Light, in pairs only
8GH 008 358-241	1	24V70W
8GH 008 358-251	1	24V70W Double Power

For H9-headlights and driving lights

Part no.	Pk.	
8GH 008 357-001	1	H9, ECE-R 37, bulb cap PGJ 19-5, 12V65W
8GH 008 357-151	1	12V65W + 30, in pairs only

For H8-headlights

Part no.	Pk.	
8GH 008 356-121	1	H8, ECE-R 37, bulb cap PGJ 19-1, 12V35W
8GH 008 356-151	1	12V35W Blue Light, in pairs only
8GH 008 356-181	1	12V35W + 30, in pairs only

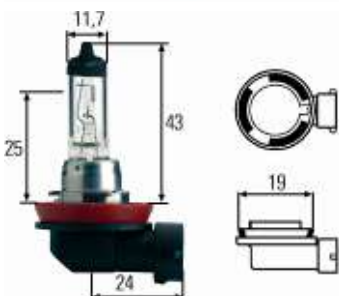
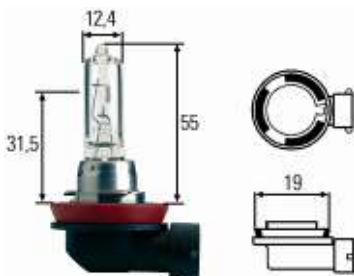
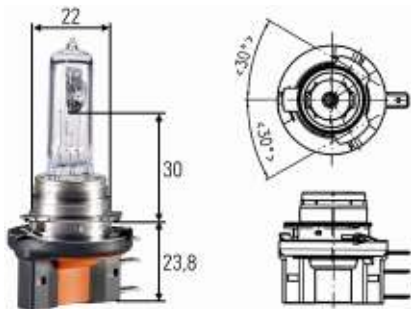

Bulbs for headlights

For H7 headlights and fog lights



Part no.	Pk.	
8GH 007 157-121	1	H7, ECE-R 37, bulb cap PX 26 d, 12V55W
8GH 007 157-181	1	12V55W Blue Light, in pairs only
8GH 007 157-201	1	12V55W Long Life
8GH 007 157-471	1	12V55W + 50, in pairs only
8GH 007 157-531	1	12V55W + 90, in pairs only
8GH 007 157-481	1	12V55W Yellow Light
8GH 007 157-241	1	24V70W
8GH 007 157-231	1	24V70W Long Life

For H4 headlights

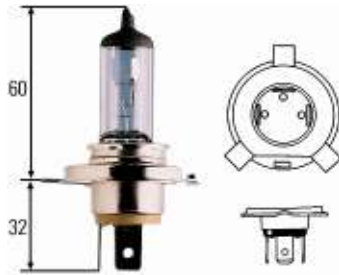

Part no.	Pk.	
8GJ 002 525-131	1	H4, ECE-R 37, bulb cap P 43 t-38, 12V60/55W
8GJ 002 525-133	1	12V60/55W
8GJ 002 525-001	1	12V60/55W + 30, Long Life, in pairs only
8GJ 002 525-471	1	12V60/55W + 50, in pairs only
8GJ 002 525-531	1	12V60/55W + 90, in pairs only
8XS 002 525-961	1	12V60/55W 10 sets, + 50, in pairs only
8GJ 002 525-361	1	12V60/55W Blue Light, in pairs only
8GJ 002 525-301	1	12V60/55W Heavy Duty
8GJ 002 525-481	1	12V60/55W Long Life
8GJ 002 525-341	1	12V60/55W Yellow Light
8GJ 002 525-251	1	24V75/70W
8GJ 002 525-253	1	24V75/70W
8GJ 002 525-281	1	24V75/70W Heavy Duty
8GJ 002 525-511	1	24V75/70W Double Power
8GJ 004 173-121	1	H4, ECE-R 37, bulb cap P 45t, 12V60/55W
8GJ 003 133-242	1	24V75/70W



For HB4a dipped-beam headlights



Part no.	Pk.	
8GH 005 636-201	1	HB4a, ECE-R 37, bulb cap P 22 d, 12V51W

For HB4 dipped-beam headlights

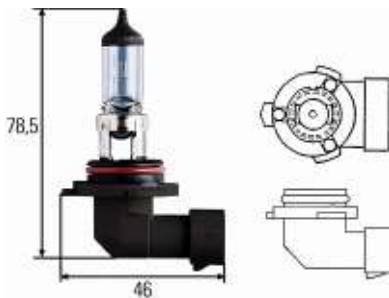

Part no.	Pk.	
8GH 005 636-121	1	HB4, ECE-R 37, bulb cap P 22 d, 12V51W

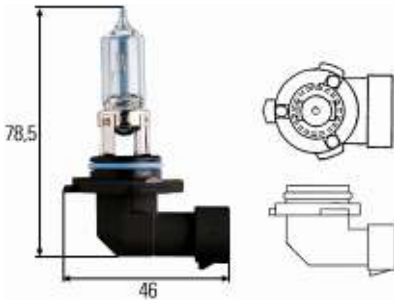

Bulbs for headlights

For HB3a main-beam headlights

Part no.	Pk.	
8GH 005 635-161	1	HB3a, ECE-R 37, bulb cap P 20 d, 12V60W

For HB3 main-beam headlights

Part no.	Pk.	
8GH 005 635-121	1	HB3, ECE-R 37, bulb cap P 20 d, 12V60W
8GH 005 635-181	1	12V60W Long Life

For H3 dipped-beam headlights, driving, fog and work lights

Part no.	Pk.	
8GH 002 090-133	1	H3, ECE-R 37, bulb cap PK 22 s, 12V55W
8GH 002 090-271	1	
8GH 002 090-371	1	12V55W Blue Light, in pairs only
8GH 002 090-481	1	12V55W Yellow Light
8GH 002 090-251	1	24V70W
8GH 002 090-253	1	
8GH 002 090-471	1	24V70W Double Power

For H2 driving and fog lights

Part no.	Pk.	
8GH 002 857-121	1	H2, DIN 72 601, bulb cap X 511, 12V55W
8GH 002 857-241	1	24V70W

For H1 headlights, fog lights and rotating beacons

Part no.	Pk.	
8GH 002 089-133	1	H1, ECE-R 37, bulb cap P 14.5 s, 12V55W
8GH 002 089-141	1	12V55W Blue Light, in pairs only
8GH 002 089-501	1	12V55W Yellow Light
8GH 002 089-351	1	12V55W Long Life
8GH 002 089-471	1	12V55W + 50, in pairs only
8GH 002 089-531	1	12V55W + 90, in pairs only
8GH 002 089-801	1	12V55W set, + 50, in pairs only
8GH 002 089-251	1	24V70W
8GH 002 089-253	1	24V70W
8GH 002 089-361	1	24V70W Heavy Duty
8GH 002 089-491	1	24V70W Double Power



Bulbs for headlights

For asymmetrical R2 headlights

Part no.	Pk.	
8GD 002 088-071	1	R2, ECE-R 37, bulb cap P 45 t-41, 6V45/40W
8GD 002 088-131	1	12V45/40W
8GD 002 088-251	1	24V55/50W

For symmetrical S1 headlights for two wheeled vehicles

Part no.	Pk.	
8GD 008 897-061	1	S1, ECE-R 37, bulb cap BA 20 d, 6V25/25W
8GD 008 897-121	1	12V25/25W

For symmetrical S2 headlights

Part no.	Pk.	
8GD 008 898-061	1	S2, ECE-R 37, bulb cap BA 20 d, 6V35/35W
8GD 002 084-131	1	12V35/35W
8GD 002 084-151	1	12V45/40W
8GD 002 084-251	1	24V45/40W

For S3 driving lights for two wheeled vehicles

Part no.	Pk.	
8GA 008 899-061	10	S3, ECE-R 37, bulb cap P 26 s, 6V15W
8GA 008 899-121	10	12V15W

For F2 work lights, fog lights, rear fog lights and reversing lights

Part no.	Pk.	
8GA 002 083-131	1	F2, DIN 72 601, bulb cap BA 20 s, 12V35W
8GA 002 083-251	1	24V35W

For indicator lights

Part no.	Pk.	
8GH 008 417-001	1	H21W, ECE-R 37, bulb cap BAY 9 s, 12V21W Long Life
8GH 008 417-012	1	24V21W



Bulbs for headlights

For position lights

Part no.	Pk.	
8GP 002 067-061	10	T4W, ECE-R 37, bulb cap BA 9 s,
8GP 002 067-121	10	6V4W
8GP 002 067-281	10	12V4W
8GP 002 067-241	10	12V4W Long Life
8GP 002 067-241	10	24V4W
8GP 002 067-261	10	24V4W Heavy Duty

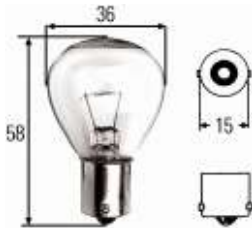

Bulbs for signal lights

For rotating beacons

Part no.	Pk.	
8GA 002 074-121	1	U, DIN 72 601, bulb cap BA 15 s,
8GA 002 074-241	1	12V45W
		24V45W



For rear-stop or rear-indicator lights

Part no.	Pk.	
8GD 002 078-121	10	P21/5W, ECE-R 37, bulb cap BAY 15 d,
8GD 002 078-221	10	12V21/5W
8GD 002 078-112	10	12V21/5W Long Life
8GD 002 078-241	10	12V21/5W Heavy Duty
8GD 002 078-241	10	24V21/5W
8GD 002 078-011	10	24V21/5W Heavy Duty



For rear-stop lights or rear-fog lights

Part no.	Pk.	
8GD 004 772-121	10	P21/4W, ECE-R 37, bulb cap BAZ 15 d,
8GD 004 772-151	10	12V21/4W
		12V21/4W Long Life

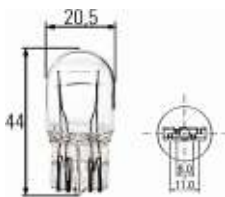

For rear and stop lights

Part no.	Pk.	
8GD 008 893-002	10	W21/5W, bulb cap W 3 x 16 g,
		12V21/5W



For indicator, stop, rear fog and reverse lights

Part no.	Pk.	
8GA 002 073-121	10	P21W, ECE-R 37, bulb cap BA 15 s,
8GA 002 073-271	10	12V21W
8GA 002 073-241	10	12V21W Long Life
8GA 002 073-241	10	24V21W
8GA 002 073-251	10	24V21W Heavy Duty



For indicator lights

Part no.	Pk.	
8GA 006 841-121	10	PY21W, ECE-R 37, bulb cap BAU 15 s,
8GA 006 841-801	1	12V21W amber
8GA 006 841-241	10	12V21W Magic Star (2 pieces)
8GA 006 841-241	10	24V21W amber
8GA 006 841-251	10	24V21W amber Heavy Duty

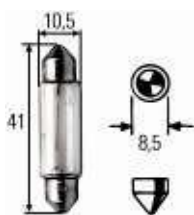

Bulbs for signal lights

For indicator and stop lights
(older versions)

Part no.	Pk.	
8GA 002 072-121	10	R, DIN 72 601, bulb cap BA 15 s, 12V18W
8GA 002 072-241	10	24V18W

For rear, license plate, side, clearance and interior lights

Part no.	Pk.	
8GA 002 071-121	10	R5W, ECE-R 37, bulb cap BA 15 s, 12V5W
8GA 002 071-351	10	12V5W Long Life
8GA 002 071-241	10	24V5W
8GA 002 071-261	10	24V5W Heavy Duty
8GA 002 071-361	10	R5W, ECE-R 37, bulb cap BA 15 d, 24V5W

For rear, license plate, side, clearance and interior lights

Part no.	Pk.	
8GA 002 071-131	10	R10W, ECE-R 37, bulb cap BA 15 s, 12V10W
8GA 002 071-341	10	12V10W Long Life
8GA 002 071-251	10	24V10W
8GA 002 071-271	10	24V10W Heavy Duty

For reverse, interior and reading lights

Part no.	Pk.	
8GH 002 473-132	1	YL, bulb cap BA 9s, 12V20W
8GH 002 473-151	1	12V5W
8GH 002 473-191	10	12V10W

For halogen position lights and daytime running lights

Part no.	Pk.	
8GH 007 643-121	10	H6W, ECE-R 37, bulb cap BAX 9 s, 12V6W
8GH 007 643-171	10	12V6W Long Life

For indicator lights

Part no.	Pk.	
8GH 008 417-001	1	H21W, bulb cap BAY 9 s, 12V21W Long Life
8GH 008 417-012	10	24V21W

For stop and indicator lights

Part no.	Pk.	
8GM 002 091-121	10	K, DIN 72 601, bulb cap SV 8.5, 12V18W
8GM 002 091-241	10	24V18W

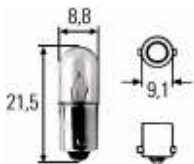
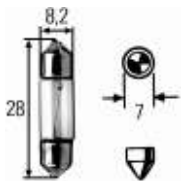
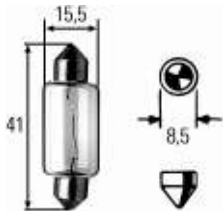
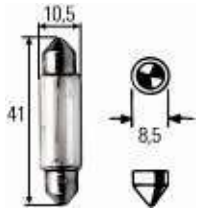
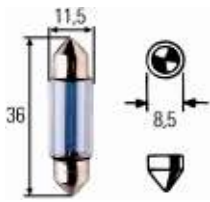

Bulbs for signal lights

For rear, licence plate, side, clearance and interior lights

Part no.	Pk.	
8GM 002 092-121	10	C5W, ECE-R 37, bulb cap SV 8.5, 12V5W
8GM 002 092-171	10	12V5W Long Life
8GM 002 092-241	10	24V5W

For lights

Part no.	Pk.	
8GM 002 091-131	10	K, DIN 72 601, bulb cap SV 8.5, 12V10W
8GM 002 091-251	10	24V10W

For reverse lights (older versions)

Part no.	Pk.	
8GM 002 091-141	10	Bulb cap SV 8.5, 12V15W
8GM 002 091-261	10	24V15W
8GM 002 091-121	10	12V18W
8GM 002 091-181	10	C21W, ECE-R 37, bulb cap SV 8.5, 12V21W

For lights

Part no.	Pk.	
8GM 002 094-121	10	M, bulb cap SV 7-8, 12V3W
8GM 002 094-241	10	24V3W

For interior and reading lights

Part no.	Pk.	
8GP 002 067-061	10	T4W, ECE-R 37, bulb cap BA 9 s, 6V4W
8GP 002 067-121	10	12V4W
8GP 002 067-281	10	12V4W Long Life
8GP 002 067-241	10	24V4W
8GP 002 067-261	10	24V4W Heavy Duty

For interior and reading lights

Part no.	Pk.	
8GP 007 676-121	10	Xenon, T6W, ECE-R37, bulb cap BA 9 s, 12V6W

For reading lights and hand lamps

Part no.	Pk.	
8GP 008 285-001	1	Xenon, bulb cap BA 9 s, 24V7,5W

For interior lights and dashboard lighting

Part no.	Pk.	
8GP 002 068-121	10	H, (T2W/T3W) DIN 49 715, bulb cap BA 9 s, 12V2W
8GP 002 068-131	10	12V3W
8GP 002 068-241	10	24V2W

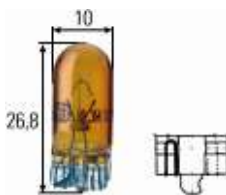
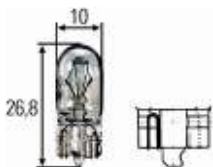
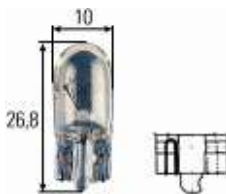
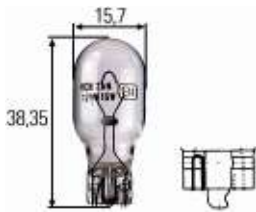

Bulbs for signal lights

For hazard warning flasher lights

Part no.	Pk.	
8GP 002 096-061	10	B2.4W, DIN 49 848, bulb cap EP 10, 6V2.4W

For warning lights and switches

Part no.	Pk.	
8GP 002 066-121	10	J, DIN 72 601, bulb cap BA 7 s, 12V2W
8GP 002 066-241	10	24V2W
8GP 002 066-017	600	24V40mA

For position lights

Part no.	Pk.	
8GA 008 246-001	10	W16W, ECE-R 37, bulb cap W 2.1 x 9.5 d, 12V16W

For stop lights

Part no.	Pk.	
8GA 008 892-002	10	W21W, ECE-R 37, bulb cap W 3 x 16 d, 12V21W

For position lights and numberplate lights

Part no.	Pk.	
8GP 003 594-141	10	W3W, ECE-R37, bulb cap W 2.1 x 9.5 d, 12V3W
8GP 003 594-241	10	24V3W
8GP 003 594-121	10	W5W, ECE-R 37, bulb cap W 2.1 x 9.5 d, 12V5W
8GP 003 594-261	1	12V5W Blue Light, in pairs only
8GP 003 594-251	10	24V5W
8GP 003 594-002	10	W6W, bulb cap W 2.1 x 9.5 d, 12V6W

For dashboard lighting

Part no.	Pk.	
8GA 008 901-241	10	Bulb cap W 2.1 x 9.5 d, 24V2W

For position lights

Part no.	Pk.	
8GP 003 594-541	10	WY5W, ECE-R 37, bulb cap W 2.1 x 9.5 d, 12V5W amber
8GP 003 594-547	1000	

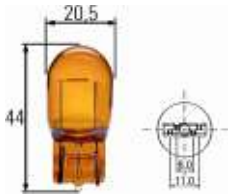

Bulbs for signal lights

For indicator lights

Part no.	Pk.	
8GP 009 021-002	10	WY21W, ECE-R 37, bulb cap W 3 x 16 d, 12V21W, yellow



For warning lights and switches

Part no.	Pk.	
8GP 002 095-121	10	W1,2W, DIN 72 601, bulb cap W 2 x 4.6 d, 12V1,2W
8GP 002 095-241	10	24V1,2W



For safety brake lights

Part no.	Pk.	
8GP 938 026-001	10	W2,3W, ECE-R 37, bulb cap W 2 x 4.6 d, 12V2,3W

Fluorescent tubes

For ceiling lights

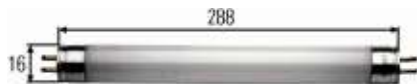

Part no.	Pk.	
8GS 002 296-111	1	TL, bulb cap G5/11x15 Light flux 450 lm, 4000 Kelvin, 8W, Light colour 25, cold white, 12V8W
8GS 002 296-101	1	Light flux > 300 lm, 2950 Kelvin, 8W, Light colour 32, soft glow, 12V8W
8GS 861 953-011	1	Light flux 850 lm, 3450 Kelvin, 13W, Light colour 35, white, 12V13W

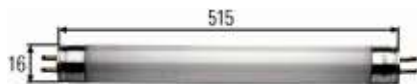

For interior lights



Part no.	Pk.	
8GS 861 955-001	1	PL, bulb cap 2G7, 4000 Kelvin, cold white, 113 mm, 12V/24V7W
8GS 861 955-011	1	4000 Kelvin, cold white, 144 mm, 12V/24V9W
8GS 861 955-021	1	4000 Kelvin, cold white, 212 mm, 12V/24V11W
8GS 861 955-031	1	2700 Kelvin, cold white, 212 mm, 12V/24V11W

Bulb with glass cap

For dashboard lighting

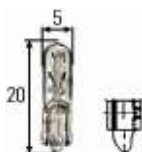

Part no.	Pk.	
8GA 007 997-181	10	Bulb cap W 2 x 4.6 d, 24V2W



Bulbs with plastic caps

For dashboard and interior lighting

Part no.	Pk.	
8GA 007 997-011	10	Bulb cap W 2 x 4.6 d, white, 12V1,2W
8GA 007 997-021	10	24V1W



For dashboard and interior lighting

Part no.	Pk.	
8GA 007 997-001	10	Bulb cap B 8.3 d, white, 12V2W
8GA 007 997-061	10	Bulb cap B 8.3 d, grey, 24V1,2W
8GA 007 997-041	10	Bulb cap B 8.3 d, black, 12V1,2W



For dashboard and interior lighting

Part no.	Pk.	
8GA 007 997-161	10	Bulb cap B 8.5 d, beige, 12V1,5W
8GA 007 997-071	10	Bulb cap B 8.5 d, grey, 24V1,2W
8GA 007 997-081	10	Bulb cap B 8.5 d, green, 12V2W



For dashboard and interior lighting

Part no.	Pk.	
8GA 007 997-051	10	Bulb cap B 8.7 d, grey, 12V1,2W
8GA 007 997-091	10	Bulb cap B 8.7 d, green, 12V2W



Bulbs with plastic caps

For dashboard and interior lighting



Part no.	Pk.	
8GA 007 997-101	10	Mini-halogen, Bulb cap B 10 d, brown, 12V3W
8GA 007 997-111	10	12V5W

For dashboard and interior lighting



Part no.	Pk.	
8GA 007 997-121	10	Bulb cap BX 8,4 d, black, 12V1,2W
8GA 007 997-131	10	Bulb cap BX 8,4 d, green, 12V1,3W
8GA 007 997-141	10	1Bulb cap BX 8,4 d, beige, 2V1,5W
8GA 007 997-171	10	Bulb cap BX 8,4 d, amber, 12V1,1W
8GS 006 677-121	10	Bulb cap BX 8,4 d, white/green 12V2W

Bulbs with plastic caps

For dashboard and interior lighting



Part no.	Pk.	
8GA 007 997-151	10	Bulb cap BX 8.5 d, blue violet, 12V0.36W
8GA 007 997-211	10	Bulb cap BX 8.5 d, light blue, 12V1.2W
8GA 007 997-221	10	Bulb cap BX 8.5 d, light green, 12V2W
8GA 007 997-261	10	Bulb cap BX 8.5 d, brown, 24V1.2W

For dashboard and interior lighting



Part no.	Pk.	
8GA 007 997-191	10	Bulb cap EBS R4, yellow, 24V1.2W
8GA 007 997-201	10	Bulb cap EBS R6, brown, 24V1.2W
8GA 007 997-272	10	Bulb cap EBS N10, beige, 24V1.2W

For dashboard and interior lighting



Part no.	Pk.	
8GA 007 997-231	10	Bulb cap BG 8.5 - 5.5 d, black, 12V1.2W

For dashboard and interior lighting



Part no.	Pk.	
8GA 007 997-241	10	Bulb cap SG 8 - 5,5 d, black, 12V1.2W



Bulbs with plastic caps

For dashboard and interior lighting

Part no.	Pk.	
8GA 007 997-251	10	Bulb cap B 8.5 S - 40, black, 12V1,2W

Bulb holders



Part no.	Pk.	
9FF 085 081-001	10	Bulb cap BA 15 s, 1-pole, DIN 49 725, with blade terminal contact
9FF 138 324-001 9FF 133 025-007	10 20	Bulb cap BA 15 s, 1-pole, with blade terminal contact with screw-type contact
9FF 071 116-001	10	Bulb cap BAY 15 d, 2-pole, with screw-type contact
9FF 078 830-001	10	Bulb cap BA 9 s, 1-pole,
9FF 042 509-001	10	Bulb cap BA 7 s, 1-pole, with blade terminal contact
9FF 135 906-021	10	Bulb cap X 511, with blade terminal contact

Connectors

Connector for H4- or R2-bulbs.

For cable cross-section. 2,5 sq. mm.

Cable connection via clamping, can be released via push-buttons.



Part no.	Pk.	
8JA 001 909-001	10	3-pole connector, without earthing cable
8JA 001 909-011	10	with earthing cable 130 mm long
8JA 001 914-011	10	3-pole connector, with earthing cable 130 mm long

Connector for H3 bulbs



Part no.	Pk.	
8JA 990 295-217	10	HB3 connector



Connectors

Plug with preinstalled leads and butt connectors for H1 bulbs.

To fit leads with max. cross-section up to 1.0 mm² .
Crimped lead connections.
Length of brown lead (earth): 60 mm.
Length of white lead: 40 mm.

Part no.	Pk.	
8KB 863 949-001	1	Connectors



Plug with preinstalled leads and butt connectors for H7 bulbs.

To fit leads with max. cross-section up to 1.0 mm² .
Crimped lead connections.
Length of brown lead (earth): 120 mm.
Length of white lead: 100 mm.

Part no.	Pk.	
8KB 863 949-011	1	Connectors

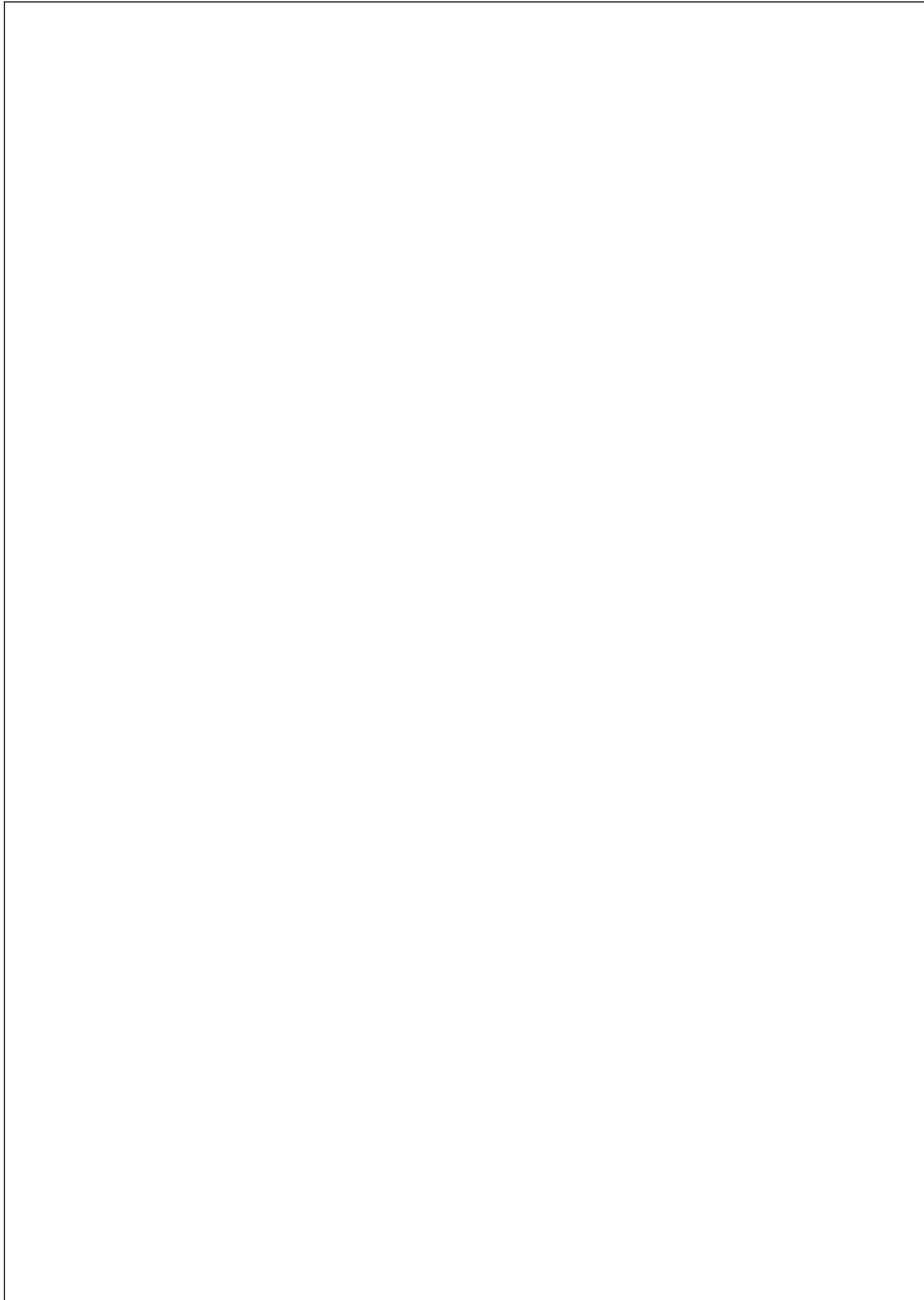



---	---	---
---	---	---
---	---	---
---	---	---
---	---	---
---	---	---
---	---	---
---	---	---
---	---	---
---	---	---

List of part numbers

9.02-9.15

Vehicle manufacturer's no. - Hella no.

9.16-9.53

List of type approval numbers

9.54-9.67

Note:

The original numbers listed in the manufacturer number - Hella number comparison serve exclusively for comparison purposes and are not to be used otherwise.

List of Part Numbers



Part number	Page	Part number	Page	Part number	Page	Part number	Page
1BL...		1F8...		1FE...		1GA...	
1BL 007 834-007	3.70, 4.37	1F8 007 560-211	4.14	1FE 008 773-021	4.24	1GA 006 991-041	4.72
1BL 007 834-037	4.37	1F8 007 560-301	4.13	1FE 008 773-041	4.23	1GA 006 991-051	4.71
1BL 007 834-047	4.37	1F8 007 560-311	4.15	1FE 008 773-051	4.24	1GA 006 991-061	4.71
1BL 007 834-132	4.37	1F8 007 560-321	4.15	1FE 008 773-061	4.23	1GA 006 991-071	4.72
1DL...		1F8 007 560-331	4.15	1FE 008 773-081	4.23	1GA 006 991-081	4.72
1DL 005 600-097	4.43	1F8 007 560-341	4.15	1FE 125 510-011	3.67	1GA 006 991-091	4.71
1DL 005 600-107	4.43	1F8 007 560-401	4.13	1FE 138 520-011	3.77, 3.80-3.81, 4.23	1GA 007 506-001	4.85
1DL 005 930-371	1.27	1F8 007 560-411	4.15	1FE 152 896-011	3.68	1GA 007 506-002	4.85
1DL 005 930-381	1.27	1F8 007 560-421	4.15	1FE 158 877-011	4.23	1GA 007 506-007	4.85
1DL 007 872-017	4.43	1F8 007 560-451	4.15	1FE 161 576-011	4.24	1GA 007 506-011	4.86
1DL 007 872-027	4.43	1F8 007 560-561	4.16	1FE 161 641-011	4.23	1GA 007 506-012	4.86
1DL 007 872-037	4.43	1F8 007 560-571	4.16	1FE 161 641-021	4.23	1GA 007 506-021	4.88
1DL 007 872-047	4.43	1F8 007 560-621	4.16	1FE 161 642-011	4.23	1GA 007 506-061	4.84
1DL 007 872-077	4.43	1F8 007 560-631	4.16	1FE 161 644-011	4.23	1GA 007 506-081	4.85
1DL 007 872-087	4.43	1F8 007 560-721	4.16			1GA 007 506-091	4.86
		1F8 007 560-731	4.16	1G0...		1GA 007 506-101	4.88
		1F8 009 797-021	4.12	1G0 996 176-001	4.110	1GA 007 506-111	4.84
		1F8 009 797-031	4.12	1G0 996 176-002	4.110	1GA 007 506-121	4.84
		1F8 009 797-101	4.12	1G0 996 176-007	4.110	1GA 007 506-391	4.85
1F0...		1F8 009 797-111	4.12	1G0 996 176-011	4.110	1GA 007 506-431	4.84
1F0 008 390-001	4.26	1F8 009 797-121	4.12	1G0 996 176-021	4.109	1GA 007 506-451	4.87
1F0 008 390-301	4.28	1F8 009 797-131	4.12	1G0 996 176-031	4.109	1GA 007 506-491	4.87
1F0 008 390-317	4.28	1F8 009 797-321	4.12	1G0 996 176-041	4.114	1GA 007 506-651	4.87
1F0 008 390-327	4.28	1F8 009 797-331	4.12	1G0 996 176-051	4.114	1GA 007 506-681	4.97
1F0 008 390-801	4.26	1F8 009 797-341	4.12	1G0 996 176-061	4.113	1GA 008 284-101	6.38, 6.50
1F0 008 390-821	4.28	1F8 009 797-351	4.12	1G0 996 176-111	4.110	1GA 132 459-011	4.73
1F0 010 186-001	4.07	1F8 009 797-421	4.12	1G0 996 176-112	4.110	1GA 990 305-001	4.80, 4.83
1F0 010 186-201	4.08	1F8 009 797-431	4.12	1G0 996 176-121	4.110	1GA 990 305-011	4.81, 4.121
1F0 010 293-001	4.30	1F8 011 002-001	4.17	1G0 996 176-131	4.114	1GA 996 020-001	4.79
1F0 160 197-001	4.26, 4.28	1F8 147 077-011	4.10	1G0 996 176-141	4.114	1GA 996 082-001	4.76
1F0 172 877-011	4.07	1F8 148 009-011	4.13	1G0 996 176-171	4.114	1GA 996 083-001	4.89
		1F8 148 131-011	4.13, 4.15	1G0 996 176-181	4.114	1GA 996 083-011	4.89
1F1...		1F8 149 644-011	4.16	1G0 996 176-361	4.111	1GA 996 083-021	4.89
1F1 009 094-041	4.06	1F8 157 042-011	4.11	1G0 996 176-621	4.111	1GA 996 140-021	4.65
1F1 009 094-051	4.06	1F8 158 926-011	4.15	1G0 996 176-631	4.111	1GA 996 142-001	4.80
1F1 009 094-091	4.06	1F8 161 326-011	4.10, 4.14	1G0 996 176-671	4.114	1GA 996 142-011	4.80
1F1 161 825-021	4.06	1F8 162 870-011	4.12-4.13, 4.15	1G0 996 176-681	4.112	1GA 996 142-021	4.80
1F1 161 825-041	4.06	1F8 162 870-031	4.12-4.13, 4.15	1G0 996 176-691	4.112	1GA 996 142-041	4.80
		1F8 162 871-011	4.12, 4.15	1G0 996 176-701	4.113	1GA 996 142-061	4.81
1F3...		1F8 162 871-021	4.12, 4.15	1G0 996 176-711	4.113	1GA 996 142-071	4.81
1F3 009 094-021	4.07	1F8 162 872-011	4.10	1G0 996 176-721	4.113	1GA 996 142-081	4.81
1F3 009 094-031	4.07	1F8 162 873-011	4.10	1G0 996 176-723	4.113	1GA 996 142-091	4.81
1F3 009 094-061	4.07	1F8 162 874-011	4.11	1G0 996 176-741	4.113	1GA 996 142-131	4.81
1F3 009 094-071	4.07	1F8 165 940-011	4.11	1G0 996 276-357	4.112	1GA 996 142-141	4.80
1F3 009 094-142	4.08	1F8 165 941-011	4.10			1GA 996 142-151	4.81
1F3 009 094-171	4.07	1F8 165 942-011	4.11	1G3...		1GA 996 142-221	4.121
1F3 009 094-311	4.08	1F8 165 943-011	4.10	1G3 003 710-021	4.108	1GA 996 142-241	4.80
1F3 010 119-001	4.13	1F8 165 946-011	4.12, 4.15	1G3 005 760-001	4.48	1GA 996 142-251	4.81
1F3 010 119-011	4.13	1F8 165 947-011	4.12, 4.15	1G3 005 760-011	4.48	1GA 996 142-311	4.80
1F3 010 119-021	4.13	1F8 165 949-011	4.16	1G3 005 760-021	4.47	1GA 996 142-311	4.80
1F3 161 825-011	4.07, 4.13	1F8 173 055-021	4.16	1G3 005 760-031	4.48	1GA 996 150-021	4.96
1F3 161 825-031	4.07, 4.13	1F8 180 789-001	4.12, 4.15	1G3 005 760-041	4.49	1GA 996 150-071	4.96
1F3 161 825-071	4.08			1G3 005 760-057	4.49	1GA 996 150-081	4.96
1F3 161 825-081	4.07, 4.13	1FA...		1G3 005 760-201	4.48	1GA 996 150-151	4.97
		1FA 007 133-021	4.20	1G3 005 760-207	4.48	1GA 996 161-101	4.51
1F4...		1FA 007 891-061	4.19	1G3 005 760-207	4.48	1GA 996 161-111	4.50
1F4 002 608-001	4.05	1FA 007 891-811	4.19	1G3 005 760-211	4.48	1GA 996 161-121	4.54
1F4 005 750-071	4.05	1FA 007 891-841	4.19	1G3 005 760-221	4.47	1GA 996 161-131	4.56
1F4 005 750-301	4.05	1FA 008 283-011	4.18	1G3 005 760-227	4.47	1GA 996 161-281	4.52
1F4 005 750-811	4.05	1FA 008 283-031	4.18	1G3 135 211-011	4.47-4.48	1GA 996 161-291	4.55
1F4 005 750-871	4.05	1FA 008 283-811	4.18	1G3 141 019-011	4.49	1GA 996 161-331	4.56
1F4 007 893-021	4.04	1FA 008 283-861	4.18	1G3 996 001-001	4.115	1GA 996 161-351	4.50
1F4 007 893-081	4.04	1FA 008 284-011	4.18	1G3 996 001-041	4.115	1GA 996 161-391	4.59
1F4 007 893-141	4.04	1FA 008 284-031	4.18	1G3 996 001-131	4.115	1GA 996 161-581	4.54
1F4 007 893-191	4.04	1FA 008 284-811	4.18	1G3 996 001-271	4.116	1GA 996 161-671	4.51
1F4 007 893-201	4.04	1FA 008 284-861	4.18	1G3 996 001-301	4.116	1GA 996 179-001	4.78
1F4 007 893-241	4.04	1FA 010 047-001	4.17	1G3 996 001-331	4.116	1GA 996 179-021	4.78
1F4 007 893-811	4.04	1FA 010 047-011	4.17	1G3 996 001-351	4.116	1GA 996 188-001	4.98
1F4 007 893-841	4.04	1FA 010 047-801	4.17	1G3 996 001-391	4.115	1GA 996 188-011	4.98
1F4 007 893-871	4.04	1FA 149 504-011	4.19			1GA 996 188-021	4.98
1F4 007 893-911	4.04			1G4...		1GA 996 189-001	4.99
1F4 007 893-921	4.04	1FB...		1G4 003 470-001	4.117	1GA 996 189-031	4.99
1F4 135 230-011	4.05	1FB 005 860-031	4.21	1G4 003 470-011	4.117	1GA 996 192-001	4.99
1F4 149 537-011	4.04	1FB 005 860-061	4.21	1G4 003 470-031	4.117	1GA 996 242-111	4.83
1F4 157 022-011	4.04	1FB 005 860-831	4.21	1G4 003 470-051	4.117	1GA 996 242-521	4.83
1F4 160 300-011	4.04	1FB 007 892-011	4.20	1G4 003 470-141	4.117	1GA 996 242-541	4.82
1F4 160 302-011	4.04	1FB 007 892-071	4.20	1G4 003 470-147	4.117	1GA 996 261-511	4.57
1F4 162 883-011	4.04	1FB 007 892-131	4.20	1G4 004 480-001	4.118	1GA 996 261-521	4.57
		1FB 007 892-811	4.20	1G4 004 480-011	4.118	1GA 996 261-531	4.58
1F5...		1FB 007 892-841	4.20	1G4 997 033-011	4.118	1GA 996 261-561	4.58
1F5 008 273-041	4.09	1FB 137 006-021	4.21			1GA 996 261-571	4.58
1F5 154 875-011	4.09	1FB 149 519-011	4.20	1G5...		1GA 996 261-581	4.59
		1FB 162 881-011	4.20	1G5 003 241-021	4.119	1GA 996 261-691	4.58
1F6...				1G5 003 241-071	4.119	1GA 996 261-701	4.58
1F6 003 939-031	3.05	1FD...		1G5 003 241-081	4.119	1GA 996 261-711	4.58
		1FD 003 590-411	4.21	1G5 119 738-001	4.119	1GA 996 361-011	4.56
1F7...		1FD 005 700-051	4.22	1G5 120 510-001	4.119	1GA 996 361-171	4.54
1F7 004 700-431	4.09	1FD 005 700-301	4.22			1GA 996 361-421	4.54
		1FD 005 700-851	4.22	1G8...		1GA 996 361-431	4.51
1F8...		1FD 135 198-011	4.21-4.22	1G8 002 340-001	4.120	1GA 996 361-501	4.54
1F8 006 800-191	4.10			1G8 002 340-011	4.120	1GA 996 361-581	4.50
1F8 006 800-221	4.11	1FE...		1G8 132 233-011	4.120	1GA 996 461-311	4.60
1F8 006 800-301	4.10	1FE 002 537-191	4.22			1GA 996 461-321	4.60
1F8 006 800-311	4.10	1FE 002 537-481	3.68	1G9...		1GA 996 461-331	4.60
1F8 006 800-321	4.11	1FE 005 478-011	3.21, 3.23	1G9 001 523-021	4.121	1GA 996 461-341	4.60
1F8 006 800-331	4.11	1FE 005 478-021	3.21, 3.23			1GA 996 461-547	4.54
1F8 006 800-341	4.10	1FE 006 300-001	4.23	1GA...		1GA 996 461-591	4.61
1F8 006 800-351	4.11	1FE 006 300-041	4.23	1GA 005 060-001	4.73		



List of Part Numbers

Part number	Page	Part number	Page	Part number	Page	Part number	Page
1GA...		1H5...		1LA...		1LG...	
1GA 997 506-557	4.88	1H5 998 502-051	4.126	1LA 990 185-011	4.64	1LG 003 434-187	3.12, 3.14-3.15, 3.19, 4.44
1GA 997 506-601	4.86	1K0...		1LA 993 975-037	4.64	1LG 003 434-237	3.20-3.21, 3.27, 3.30, 3.32
1GA 997 506-631	4.88	1K0 008 191-001	4.31	1LA 993 975-047	4.64	1LG 004 679-051	3.75, 3.78, 3.81
1GA 998 522-011	4.74	1K0 008 191-007	4.31	1LA 996 074-037	4.63	1LG 005 480-031	3.09
1GA 998 522-407	4.74	1K0 008 191-011	4.31	1LA 996 074-047	4.63	1LG 005 480-041	3.09
1GA 998 524-001	4.71	1K0 008 191-017	4.31	1LA 996 074-197	4.63	1LG 005 480-075	3.09
1GA 998 524-011	4.72	1K0 008 191-021	4.31	1LA 996 074-207	4.63	1LG 006 560-211	1.105-1.106
1GA 998 525-001	4.84-4.89, 4.97	1K0 008 191-027	4.31	1LA 996 127-017	4.64	1LG 006 560-221	1.105-1.106
1GA 998 525-011	4.90	1K0 008 191-041	4.31	1LB...		1LG 006 898-051	3.76
1GA 998 525-041	4.96-4.97	1K0 008 191-047	4.31	1LB 003 177-081	4.40	1LG 006 898-091	3.77, 3.79-3.80
1GA 998 525-071	4.91-4.92	1K0 008 191-212	4.31	1LB 003 177-511	1.173, 4.40	1LG 006 920-231	1.97, 1.137
1GA 998 532-011	4.79	1K0 008 191-227	4.31	1LB 006 213-047	4.65	1LG 006 920-241	1.97, 1.137
1GA 998 532-081	4.79	1K0 008 192-001	4.32	1LB 006 213-057	4.65	1LG 007 150-111	3.74
1GA 998 534-001	4.90	1K0 008 192-007	4.32	1LB 006 277-137	4.41	1LG 007 150-121	3.74
1GA 998 534-011	4.90	1K0 008 192-011	4.32	1LB 007 145-047	4.69	1LG 007 302-191	1.183-1.184
1GA 998 534-061	4.90	1K0 008 192-017	4.32	1LB 008 461-551	1.104, 2.21	1LG 007 302-201	1.183-1.184
1GA 998 534-221	4.92	1K0 008 192-027	4.32	1LB 008 461-561	1.104, 2.21	1LG 007 640-331	1.91, 1.131, 2.17, 2.25
1GA 998 534-231	4.92	1K0 008 192-091	4.32	1LB 008 461-751	1.104, 2.21	1LG 007 640-341	1.91, 1.131, 2.17, 2.25
1GA 998 534-271	4.92	1K0 158 059-061	4.32	1LB 008 461-761	1.104, 2.21	1LG 007 640-631	1.91, 1.131, 2.17, 2.25
1GA 998 534-431	4.94	1K0 247 043-001	4.33	1LB 247 011-051	3.45	1LG 007 640-641	1.91, 1.131, 2.17, 2.25
1GA 998 534-441	4.94	1K0 247 043-007	4.33	1LB 247 011-061	3.45	1LG 007 660-031	3.08
1GA 998 534-451	4.94	1K0 247 043-011	4.33	1LB 247 012-031	2.11	1LG 007 660-041	3.08
1GA 998 534-461	4.94	1K0 247 043-017	4.33	1LB 247 012-041	2.11	1LG 007 660-111	3.10
1GA 998 534-491	4.95	1K0 247 043-021	4.33	1LB 247 012-071	2.11	1LG 007 660-121	3.10
1GA 998 534-541	4.91	1K0 247 043-027	4.33	1LB 247 012-081	2.11	1LG 007 861-451	1.183-1.184
1GA 998 534-601	4.95	1K0 247 043-031	4.33	1LB 996 157-201	4.61	1LG 007 861-461	1.183-1.184
1GA 998 534-671	4.93	1K0 247 043-037	4.33	1LD...		1LG 009 627-031	1.85, 2.13
1GA 998 534-681	4.93	1K0 247 043-097	4.33	1LD 010 417-351	1.123, 1.128, 2.24	1LG 009 767-031	1.49
1GA 998 534-691	4.95	1K0 247 043-107	4.33	1LD 010 417-361	1.123, 1.128, 2.24	1LG 009 767-041	1.49
1GB...		1K0 247 043-117	4.34	1LD 246 044-231	1.62	1LG 009 901-231	1.158-1.159
1GB 006 213-101	4.68	1K0 247 043-127	4.34	1LD 246 044-241	1.62	1LG 009 901-241	1.158-1.159
1GB 006 213-107	4.68	1K0 247 043-137	4.34	1LD 247 026-271	1.62	1LG 010 011-331	1.94, 1.134
1GB 006 213-111	4.68-4.69	1K0 247 043-147	4.34	1LD 247 026-281	1.62	1LG 010 011-341	1.94, 1.134
1GB 006 213-117	4.68	1K0 247 043-157	4.34	1LD 247 038-231	1.175	1LG 010 011-391	1.94, 1.134
1GB 007 145-101	4.70	1K0 247 043-167	4.34	1LD 247 038-241	1.175	1LG 010 011-401	1.94, 1.134
1GB 007 145-107	4.70	1K2...		1LD 962 060-131	1.64, 1.90	1LG 010 196-031	1.49, 1.102, 2.03, 2.20
1GB 996 080-001	4.66	1K2 006 147-031	4.39	1LD 962 060-141	1.64, 1.90	1LG 010 196-041	1.49, 1.102, 2.03, 2.20
1GB 996 080-011	4.66	1K2 006 147-041	4.39	1LE...		1LG 246 041-031	1.85, 2.13
1GB 996 080-021	4.66	1K2 006 147-051	4.39	1LE 003 427-041	4.41	1LG 246 041-041	1.85, 2.13
1GB 996 080-031	4.66	1K3...		1LE 007 350-111	1.104, 2.20	1LG 247 007-031	1.154
1GB 996 102-101	4.75	1K3 114 155-001	4.40	1LE 007 350-121	1.104, 2.20	1LG 247 007-041	1.154
1GB 996 147-011	4.67	1K3 126 046-001	1.26	1LE 008 880-031	1.14-1.15	1LG 247 007-191	1.155, 1.158, 1.162
1GB 996 147-101	4.67	1K3 126 680-001	1.26, 1.45	1LE 008 880-041	1.14-1.15	1LG 247 007-201	1.155, 1.158, 1.162
1GB 996 158-081	4.62	1K3 132 253-011	1.33, 1.46	1LE 010 198-051	1.56	1LG 247 007-231	1.155
1GB 996 186-051	4.78	1K3 132 266-011	1.33, 1.46	1LE 010 198-061	1.56	1LG 247 007-241	1.155
1GB 996 186-061	4.78	1K3 134 855-011	1.27	1LE 010 198-091	1.56	1LG 270 370-331	1.92, 1.132, 2.17, 2.26
1GB 996 213-511	4.69	1K3 134 856-011	1.27	1LE 010 198-101	1.56	1LG 270 370-341	1.92, 1.132, 2.17, 2.26
1GD...		1KB...		1LE 010 198-161	1.56	1LG 270 370-631	1.92, 1.132, 2.18, 2.26
1GD 003 590-701	4.77	1KB 003 177-061	4.40	1LE 010 198-151	1.56	1LG 270 370-641	1.92, 1.132, 2.18, 2.26
1GD 003 690-287	4.76	1KB 003 177-597	1.173	1LE 010 199-031	1.55	1LG 354 023-031	2.05
1GD 005 700-501	4.77	1KL...		1LE 010 199-041	1.55	1LG 354 023-041	2.05
1GD 996 018-541	4.68	1KL 007 834-027	3.70, 4.37	1LE 238 055-031	1.89	1LG 354 023-071	2.05
1GD 996 193-001	4.76	1KL 007 834-067	4.37	1LE 238 055-041	1.89	1LG 354 023-081	2.06
1GL...		1KL 007 834-097	4.37	1LE 247 013-071	1.160	1LG 354 024-051	2.06
1GL 008 090-201	4.108	1KL 009 486-001	4.28	1LE 247 013-081	1.160	1LG 354 024-061	2.06
1GL 008 090-207	4.108	1KL 998 570-021	4.29	1LE 247 019-191	1.173	1LG 354 024-071	2.06
1GL 008 090-211	4.108	1KL 998 570-031	4.29	1LE 247 019-201	1.173	1LG 354 024-081	2.06
1GL 008 090-217	4.108	1L3...		1LE 247 051-031	1.173	1LG 354 024-131	2.06
1GM...		1L3 002 850-068	4.39, 4.45	1LE 247 051-041	1.173	1LG 354 024-141	2.06
1GM 990 303-151	4.103	1L3 005 649-017	4.39	1LE 270 600-191	1.62	1LH...	
1GM 996 134-051	4.106	1L3 996 002-411	4.39	1LE 270 600-201	1.62	1LH 002 658-451	3.66
1GM 996 134-061	4.106	1L3 996 026-041	4.46	1LE 354 257-051	1.59	1LH 002 658-461	3.66
1GM 996 134-071	4.106	1L6...		1LE 354 257-061	1.59	1LH 002 658-511	3.67
1GM 996 134-081	4.106	1L6 002 395-261	4.40	1LE 354 257-071	1.59	1LH 002 658-521	3.67
1GM 996 134-091	4.100	1L6 002 395-842	4.40	1LE 354 257-081	1.59	1LH 005 454-311	1.163
1GM 996 134-171	4.106	1L7...		1LF...		1LH 005 454-321	1.163
1GM 996 134-241	4.107	1L7 271 510-331	1.110	1LF 006 826-251	1.52, 2.03	1LH 006 840-271	1.164
1GM 996 134-271	4.107	1L7 271 510-341	1.110	1LF 006 826-261	1.52, 2.03	1LH 006 840-281	1.164
1GM 996 134-311	4.100	1L7 271 510-371	1.110	1LF 007 520-071	1.166	1LH 006 900-031	2.09
1GM 996 134-321	4.106	1L7 271 510-381	1.110	1LF 007 520-081	1.166	1LH 006 900-041	2.09
1GM 996 134-371	4.107	1L8...		1LF 007 620-071	1.165	1LH 008 010-031	2.10
1GM 996 135-001	4.102	1L8 003 060-561	1.80, 1.102, 1.141, 1.145, 1.179, 2.29, 2.32, 3.25, 3.38	1LF 007 620-081	1.165	1LH 008 010-041	2.10
1GM 996 135-041	4.102	1L8 003 060-691	1.80, 1.102, 1.141, 1.145, 1.179, 2.29, 2.32, 3.25, 3.38, 3.54	1LF 008 673-091	1.39	1LH 009 513-051	3.40-3.41
1GM 996 135-051	4.102	1L8 004 148-017	1.81, 1.102-1.103	1LF 008 673-101	1.39	1LH 009 513-061	3.40-3.41
1GM 996 135-101	4.103	1L8 004 190-111	1.145	1LF 009 057-031	1.65	1LH 009 513-071	3.40-3.41
1GM 996 135-111	4.103	1L8 139 474-015	1.81, 1.102-1.103	1LF 009 057-041	1.65	1LH 246 047-031	2.10
1GM 996 135-231	4.105	1L9...		1LF 009 237-031	1.51	1LH 246 047-041	2.10
1GM 996 135-241	4.105	1L9 007 095-111	1.73	1LF 009 237-041	1.51	1LH 246 047-071	2.10
1GM 996 135-251	4.105	1L9 007 095-121	1.73	1LF 010 197-031	1.54, 2.04	1LH 246 047-081	2.10
1GM 996 135-261	4.105	1L9 378 158-001	1.74	1LF 010 197-041	1.54, 2.04	1LJ...	
1GM 996 135-361	4.104	1L9 378 159-001	1.74	1LF 010 197-051	1.54, 2.04	1LJ 006 051-191	1.180, 2.33
1GM 996 135-371	4.104	1L9 378 176-001	1.74	1LF 010 541-041	1.66	1LJ 006 051-201	1.180, 2.33
1GM 996 135-551	4.101	1L9 378 177-001	1.74	1LF 010 541-031	1.66	1LJ 006 360-671	1.147
1GM 996 135-611	4.105	1LA...		1LF 010 541-041	1.66	1LJ 006 360-681	1.147
1GM 996 135-621	4.105	1LA 004 109-217	4.44	1LF 238 042-031	1.89	1LJ 007 143-051	1.28
1GM 996 136-101	4.101	1LA 004 109-227	4.44	1LF 238 042-041	1.89	1LJ 007 143-061	1.28
1GM 996 136-111	4.101	1L9...		1LF 238 042-131	1.89	1LJ 007 219-371	1.72
1GM 996 136-131	4.101	1L9 007 095-111	1.73	1LF 238 042-141	1.89	1LJ 007 219-381	1.72
1GM 996 136-191	4.101	1L9 007 095-121	1.73	1LF 354 025-111	1.68		
1GM 996 136-192	4.101	1L9 378 158-001	1.74	1LF 354 025-121	1.68		
1GM 996 136-241	4.101	1L9 378 159-001	1.74	1LF 962 489-151	1.169, 2		

List of Part Numbers



Part number	Page	Part number	Page	Part number	Page	Part number	Page
1LJ...		1LL...		1NO...		1NA...	
1LJ 007 235-251	1.146	1LL 010 201-161	1.59	1NO 009 594-011	1.09-1.11	1NA 006 790-071	1.164
1LJ 007 235-261	1.146	1LL 010 201-191	1.58	1NO 009 594-021	1.09-1.11	1NA 006 790-081	1.164
1LJ 007 833-111	1.106	1LL 010 201-201	1.58	1NO 009 617-011	1.114, 1.116	1NA 006 790-811	1.164
1LJ 007 833-121	1.106	1LL 010 201-231	1.58	1NO 010 294-001	4.30	1NA 007 039-011	1.47
1LJ 009 250-771	1.64, 1.67	1LL 010 201-241	1.58	1NO 010 294-011	4.30	1NA 007 039-021	1.47
1LJ 009 250-781	1.64, 1.67	1LL 010 202-071	1.125	1NO 010 345-011	1.26, 1.32, 1.42, 1.45	1NA 007 133-001	4.20
1LJ 009 292-821	1.147, 1.151	1LL 010 202-081	1.125	1NO 010 345-021	1.26, 1.32, 1.42, 1.45	1NA 007 891-041	4.19
1LJ 009 547-231	1.68	1LL 010 202-111	1.125	1NO 010 380-011	1.08, 1.10	1NA 007 891-821	4.19
1LJ 009 547-241	1.68	1LL 010 202-121	1.125	1NO 010 380-021	1.08, 1.10	1NA 007 976-071	1.69-1.70, 1.84
1LJ 009 587-631	1.53	1LL 010 203-031	1.142, 1.177, 2.27	1NO 010 501-001	1.25	1NA 007 976-081	1.69-1.70, 1.84
1LJ 009 587-641	1.53	1LL 010 203-041	1.142, 1.177, 2.27	1NO 010 789-011	1.185	1NA 007 976-111	1.69-1.71, 1.84
1LJ 009 630-331	1.95, 1.136	1LL 010 335-071	1.90	1NO 010 789-021	1.185	1NA 007 976-121	1.69-1.71, 1.84
1LJ 009 630-341	1.95, 1.136	1LL 010 335-081	1.90	1NO 010 843-011	1.26	1NA 007 976-231	1.69
1LJ 009 648-031	1.07	1LL 010 417-391	1.123, 1.128, 2.24	1NO 010 843-021	1.26	1NA 007 976-241	1.69
1LJ 009 648-041	1.07	1LL 010 417-401	1.123, 1.128, 2.24	1NO 010 844-011	1.176	1NA 008 283-001	4.18
1LJ 009 696-731	1.64	1LL 010 478-131	3.76, 3.79	1NO 010 844-021	1.176	1NA 008 283-801	4.18
1LJ 009 696-741	1.64	1LL 010 478-141	3.76, 3.79	1NO 010 845-011	1.09, 1.18	1NA 008 284-001	4.18
1LJ 009 925-031	1.14, 1.16	1LL 010 541-111	1.66	1NO 010 845-021	1.09, 1.18	1NA 008 284-801	4.18
1LJ 009 925-041	1.14, 1.16	1LL 010 541-121	1.66	1NO 010 846-011	1.163	1NA 009 026-011	1.36
1LJ 010 202-051	1.125	1LL 010 551-031	1.142, 2.27	1NO 010 846-021	1.163	1NA 009 026-021	1.36
1LJ 010 202-061	1.125	1LL 010 551-041	1.142, 2.27	1NO 246 039-011	1.13	1NA 009 029-011	1.91, 1.131, 2.17, 2.25
1LJ 247 045-331	1.55	1LL 010 800-031	1.79	1NO 246 039-021	1.13	1NA 009 029-021	1.91, 1.131, 2.17, 2.25
1LJ 247 045-341	1.55	1LL 010 800-041	1.79	1NO 247 003-011	1.08, 1.19	1NA 009 031-011	1.95, 1.136, 2.19, 2.27
1LJ 247 046-051	3.04-3.07	1LL 158 060-031	4.31	1NO 247 003-021	1.08, 1.19	1NA 009 031-021	1.95, 1.136, 2.19, 2.27
1LJ 247 046-061	3.04-3.07	1LL 158 085-011	1.47	1NO 270 204-051	1.113, 1.121, 1.124, 1.163	1NA 009 033-011	1.100, 1.140
1LJ 247 046-071	3.04-3.07	1LL 158 086-011	1.47	1NO 270 204-061	1.113, 1.121, 1.124, 1.163	1NA 009 033-021	1.100, 1.140
1LJ 247 046-081	3.04-3.07	1LL 160 695-001	1.40	1NO 270 255-051	1.144, 1.172	1NA 010 047-101	4.17
1LJ 354 674-031	1.49	1LL 160 696-001	1.40	1NO 270 255-061	1.144, 1.172	1NA 010 047-111	4.17
1LJ 354 674-041	1.49	1LL 163 081-001	1.40	1NO 270 481-051	1.121, 1.181, 2.23, 2.35	1NA 010 047-811	4.17
1LL...		1LL 163 082-001	1.40	1NO 270 481-061	1.121, 1.181, 2.23, 2.35	1NA 010 072-011	1.47
1LL 007 250-011	1.34	1LL 164 909-001	1.41	1NO 270 595-011	1.155	1NA 010 072-021	1.47
1LL 007 250-021	1.34	1LL 164 910-001	1.41	1NO 270 595-021	1.155	1NA 010 205-011	1.56
1LL 007 510-071	1.104, 2.20	1LL 223 151-031	1.82	1NO 270 596-051	1.142, 1.177, 2.28	1NA 010 205-021	1.56
1LL 007 510-081	1.104, 2.20	1LL 223 151-041	1.82	1NO 270 596-061	1.142, 1.177, 2.28	1NA 010 502-011	1.32
1LL 007 821-291	1.12	1LL 247 010-311	3.71-3.72	1NO 271 022-051	1.112, 1.116-1.117, 1.121	1NA 010 502-021	1.32
1LL 007 821-301	1.12	1LL 247 010-321	3.71-3.72	1NO 271 022-061	1.112, 1.116-1.117, 1.121	1NA 010 503-011	1.93, 1.100, 1.133, 1.140, 2.18, 2.26
1LL 007 950-251	1.137	1LL 247 010-331	3.71-3.72	1NO 271 247-051	1.121, 1.123, 1.128, 1.173, 1.176, 1.181, 2.23-2.24, 2.29, 2.35	1NA 010 503-021	1.93, 1.100, 1.133, 1.140, 2.18, 2.26
1LL 007 950-261	1.137	1LL 247 010-341	3.71-3.72	1NO 271 247-061	1.121, 1.123, 1.128, 1.173, 1.176, 1.181, 2.23-2.24, 2.29, 2.35	1NA 354 693-011	1.36
1LL 008 052-591	1.35	1LL 247 010-391	3.72	1NO 271 284-031	1.156	1NA 354 693-021	1.36
1LL 008 052-601	1.35	1LL 247 010-401	3.72	1NO 271 284-041	1.156	1NA 354 695-001	1.29
1LL 008 053-591	1.35	1LL 247 014-031	1.167	1NO 271 289-031	1.143-1.144, 1.160, 1.175, 1.177, 2.28	1NA 354 698-011	1.33
1LL 008 053-601	1.35	1LL 247 014-041	1.167	1NO 271 289-041	1.143-1.144, 1.160, 1.175, 1.177, 2.28	1NA 354 698-021	1.33
1LL 008 193-117	4.30	1LL 247 014-841	1.167	1NO 271 295-031	1.140, 1.156, 1.158, 1.162, 1.174	1NA 907 312-111	1.113, 1.115
1LL 008 193-127	4.30	1LL 247 045-371	1.55	1NO 271 295-041	1.162, 1.174	1NA 907 312-121	1.113, 1.115
1LL 008 194-017	4.31	1LL 247 045-381	1.55	1NO 271 296-031	1.167	1NA 961 557-731	1.115, 1.118
1LL 008 194-051	4.31	1LL 247 052-271	1.126	1NO 271 296-041	1.167	1NA 961 557-741	1.115, 1.118
1LL 008 306-151	1.07	1LL 263 064-031	1.83	1NO 354 013-011	1.15-1.16, 1.18	1NA 961 557-751	1.113, 1.115, 2.22
1LL 008 306-161	1.07	1LL 263 064-041	1.83	1NO 354 013-021	1.15-1.16, 1.18	1NA 961 557-761	1.113, 1.115, 2.22
1LL 008 320-251	1.98-1.99, 1.139	1LL 354 027-051	1.126	1NO 354 016-011	1.59, 1.62	1NA 962 490-011	1.170, 2.31
1LL 008 320-261	1.98-1.99, 1.139	1LL 354 027-061	1.126	1NO 354 016-021	1.59, 1.62	1NA 962 490-021	1.170, 2.31
1LL 008 320-331	1.99-1.100, 1.139-1.140	1LL 354 027-091	1.126	1NO 354 017-011	1.127	1NA 962 530-011	1.169, 2.31
1LL 008 320-341	1.99-1.100, 1.139-1.140	1LL 354 027-101	1.126	1NO 354 017-021	1.127	1NA 962 530-021	1.169, 2.31
1LL 008 350-031	1.167	1LL 354 687-031	1.31	1NO 354 017-031	1.127	1NA 963 022-031	1.118
1LL 008 350-041	1.167	1LL 354 687-041	1.31	1NO 354 017-041	1.127	1NA 963 022-041	1.118
1LL 008 369-171	1.75	1LL 354 689-031	1.48	1NO 354 018-011	1.124, 1.129, 2.24	1NA 963 965-051	1.114-1.115
1LL 008 369-181	1.75	1LL 354 689-041	1.48	1NO 354 018-021	1.124, 1.129, 2.24	1NA 963 965-061	1.114-1.115
1LL 008 369-271	1.76	1LR...		1NO 354 682-011	1.29, 1.31, 1.36	1NA 963 981-031	1.171
1LL 008 369-281	1.76	1LR 010 117-111	2.19, 2.22	1NO 354 682-021	1.29, 1.31, 1.36	1NA 963 981-041	1.171
1LL 008 420-331	1.47	1LR 010 117-121	2.19, 2.22	1NO 354 683-011	1.29-1.30, 1.36	1NB...	
1LL 008 420-341	1.47	1LR 246 046-531	3.71	1NO 354 683-021	1.29-1.30, 1.36	1NB 003 367-137	3.22
1LL 008 875-811	1.28	1LR 246 046-541	3.71	1NO 354 685-011	1.30	1NB 004 691-147	4.41
1LL 008 881-431	1.14, 1.16	1LR 247 017-071	2.29	1NO 354 685-021	1.30	1NB 005 394-051	1.143
1LL 008 881-441	1.14, 1.16	1LR 247 017-081	2.29	1NO 354 686-011	1.48	1NB 005 394-061	1.143
1LL 008 934-011	4.35	1LS...		1NO 354 686-021	1.48	1NB 005 860-021	4.21
1LL 008 934-031	4.35	1LS 008 369-491	1.76	1NO 354 696-011	1.42	1NB 005 860-131	4.21
1LL 009 020-231	1.97, 1.138	1LS 008 369-501	1.76	1NO 354 696-021	1.42	1NB 005 860-801	4.21
1LL 009 020-241	1.97, 1.138	1LS 008 821-331	1.72	1N3...		1NB 006 270-051	1.29
1LL 009 213-031	1.147	1LS 008 821-341	1.72	1N3 009 094-001	4.07	1NB 006 270-061	1.29
1LL 009 213-041	1.147	1M3...		1N3 009 094-011	4.07	1NB 007 555-031	1.71, 1.75, 1.84
1LL 009 260-091	1.77	1M3 114 178-001	4.40	1N3 161 825-001	4.07	1NB 007 555-041	1.71, 1.75, 1.84
1LL 009 260-101	1.77	1ML...		1N4...		1NB 007 892-001	4.20
1LL 009 260-571	1.77	1ML 009 999-011	4.36	1N4 002 608-021	4.05	1NB 007 892-041	4.20
1LL 009 260-581	1.77	1ML 009 999-051	4.36	1N4 005 750-001	4.05	1NB 007 892-821	4.20
1LL 009 300-071	1.148, 1.152	1ML 010 820-011	4.36	1N4 005 750-041	4.05	1NB 008 122-011	1.180
1LL 009 300-081	1.148, 1.152	1ML 247 042-027	4.32	1N4 005 750-801	4.05	1NB 008 122-021	1.180
1LL 009 300-831	1.105, 1.109	1ML 247 042-037	4.32	1N4 007 893-001	4.04	1NB 008 275-031	1.79, 2.11
1LL 009 447-111	1.105, 1.109	1ML 247 042-167	4.34	1N4 007 893-821	4.04	1NB 008 275-041	1.79, 2.11
1LL 009 447-121	1.105, 1.109	1ML 247 042-187	4.34	1N4 135 224-011	4.05	1NB 008 275-071	1.79
1LL 009 449-031	1.40	1ML 247 042-207	4.34	1N4 149 531-011	4.04	1NB 008 275-081	1.79
1LL 009 449-041	1.40	1ML 247 042-227	4.32	1N8...		1NB 123 581-001	1.27, 1.33, 1.45-1.46
1LL 009 476-031	1.155, 1.158, 1.162	1ML 998 570-011	4.29	1N8 006 800-001	4.10	1NB 123 582-001	1.27, 1.33, 1.45-1.46
1LL 009 476-041	1.155, 1.158, 1.162	1NO...		1N8 007 560-021	4.15	1NB 137 001-021	4.21
1LL 009 933-431	1.26	1NO 008 582-001	4.29	1N8 007 560-031	4.13	1NB 354 694-011	1.31
1LL 009 933-441	1.26	1NO 008 582-007	4.29	1N8 142 350-011	4.10	1NB 354 694-021	1.31
1LL 009 933-451	1.26	1NO 008 582-011	4.29	1N8 148 103-011	4.13, 4.15	1ND...	
1LL 009 997-011	4.35	1NO 008					



List of Part Numbers

Part number	Page	Part number	Page	Part number	Page	Part number	Page
1NE...		1ZS...		2BA...		2BA...	
1NE 002 537-201	4.22	1ZS 263 064-541	1.83	2BA 002 939-251	5.177	2BA 009 001-511	5.00
1NE 002 537-301	3.67	1ZS 354 688-031	1.31	2BA 003 014-011	5.103	2BA 009 001-531	5.00
1NE 006 300-011	4.23	1ZS 354 688-041	1.31	2BA 003 014-111	5.103	2BA 009 204-041	5.178
1NE 006 300-051	3.30, 3.33, 4.23	1ZS 354 690-031	1.48	2BA 003 022-001	3.12, 3.14, 3.16-3.17, 5.174	2BA 009 204-051	5.178
1NE 006 300-101	4.23	1ZS 354 690-041	1.48	2BA 003 022-021	3.12, 3.14, 3.16-3.17, 5.174	2BA 009 204-057	5.178
1NE 006 300-201	3.68	1ZS 354 692-031	1.32	2BA 003 022-057	5.174	2BA 010 103-801	1.168
1NE 006 300-231	3.30, 3.33	1ZS 354 692-041	1.32	2BA 003 110-011	1.86-1.87	2BA 010 118-011	1.168
1NE 007 517-051	1.53, 2.04-2.05	1ZT...		2BA 003 110-021	1.86-1.87	2BA 010 118-021	1.168
1NE 007 517-061	1.53, 2.04-2.05	1ZT 009 260-671	1.78	2BA 003 197-011	2.14	2BA 010 118-031	1.168
1NE 008 773-031	4.23	1ZT 009 260-681	1.78	2BA 003 197-021	2.14	2BA 010 118-041	1.168
1NE 138 555-011	3.30, 3.33, 4.23	1ZT 009 631-311	1.96, 1.136	2BA 003 236-021	3.52-3.54, 5.105	2BA 010 232-011	2.06
1NH...		1ZT 009 631-321	1.96, 1.136	2BA 003 236-027	5.105	2BA 010 232-021	2.06
1NH 354 671-011	1.127	1ZT 009 647-351	1.80	2BA 003 236-177	5.105	2BA 010 232-021	2.06
1NH 354 671-021	1.127	1ZT 009 647-361	1.80	2BA 003 236-321	5.106	2BA 010 232-021	2.06
1NL...		1ZT 010 012-411	1.95, 1.135	2BA 003 236-541	3.51, 5.106	2BA 010 232-021	2.06
1NL 005 150-051	1.19, 1.22	1ZT 010 012-421	1.95, 1.135	2BA 003 411-001	3.49	2BA 010 232-021	2.06
1NL 005 150-061	1.19, 1.22	1ZT 010 800-211	1.80	2BA 003 734-001	5.115	2BA 010 232-021	2.06
1NL 005 150-111	1.18-1.19, 1.21	1ZT 010 800-221	1.80	2BA 003 734-061	5.115	2BA 010 232-021	2.06
1NL 005 150-121	1.18-1.19, 1.21	2AA...		2BA 003 975-031	3.57	2BA 010 232-021	2.06
1NL 005 230-111	1.46	2AA 001 200-001	5.224	2BA 003 975-041	3.57	2BA 010 232-021	2.06
1NL 005 230-121	1.46	2AA 001 200-011	5.224	2BA 004 119-001	3.51, 3.53, 5.113	2BA 010 232-021	2.06
1NL 005 566-051	1.163	2AA 001 200-012	5.224	2BA 004 119-017	5.113	2BA 010 232-021	2.06
1NL 005 566-061	1.163	2AA 001 200-021	5.224	2BA 004 257-011	1.86	2BA 010 232-021	2.06
1NL 006 150-071	1.23	2AA 001 200-023	5.224	2BA 004 257-021	1.86	2BA 010 232-021	2.06
1NL 006 150-081	1.23	2AA 001 200-031	5.224	2BA 004 257-031	1.86	2BA 010 232-021	2.06
1NL 006 250-051	1.180, 2.34	2AA 001 200-041	5.224	2BA 004 257-041	1.86	2BA 010 232-021	2.06
1NL 006 250-061	1.180, 2.34	2AA 001 200-131	5.224	2BA 004 257-041	1.86	2BA 010 232-021	2.06
1NL 006 280-051	1.168, 2.30	2AA 001 200-141	5.224	2BA 004 693-031	1.72-1.73, 1.88	2BA 010 232-021	2.06
1NL 006 280-061	1.168, 2.30	2AA 001 200-151	5.224	2BA 004 693-041	1.72-1.73, 1.88	2BA 010 232-021	2.06
1NL 006 315-051	1.146, 1.161	2AA 001 200-201	5.224	2BA 004 693-801	1.88	2BA 010 232-021	2.06
1NL 006 315-061	1.146, 1.161	2AA 001 201-011	5.224	2BA 005 200-311	5.107	2BA 010 232-021	2.06
1NL 006 580-051	1.90, 1.131	2AA 001 204-001	5.224	2BA 005 296-031	1.20	2BA 010 232-021	2.06
1NL 006 580-061	1.90, 1.131	2AA 001 204-011	5.224	2BA 005 296-041	1.20	2BA 010 232-021	2.06
1NL 007 186-027	1.110, 2.22, 4.27	2AA 001 204-031	5.224	2BA 005 407-001	3.05	2BA 010 232-021	2.06
1NL 007 186-047	4.27	2AA 003 257-001	5.225	2BA 005 481-001	3.09	2BA 010 232-021	2.06
1NL 007 186-061	4.27	2AA 003 257-011	5.225	2BA 005 481-011	3.10	2BA 010 232-021	2.06
1NL 007 186-067	4.27	2AA 003 257-021	5.225	2BA 005 603-001	3.21, 3.23, 5.112	2BA 010 232-021	2.06
1NL 007 220-031	1.148, 1.178	2AA 003 257-031	5.225, 6.22	2BA 005 603-007	5.112	2BA 010 232-021	2.06
1NL 007 220-041	1.148, 1.178	2AA 003 257-041	5.225	2BA 005 603-011	5.112	2BA 010 232-021	2.06
1NL 007 594-031	1.64	2AA 003 257-042	5.225	2BA 005 603-017	5.112	2BA 010 232-021	2.06
1NL 007 594-041	1.64	2AA 008 592-001	5.223	2BA 005 603-117	5.112	2BA 010 232-021	2.06
1NL 007 834-017	4.37	2AA 008 592-011	5.223	2BA 005 603-217	5.112	2BA 010 232-021	2.06
1NL 007 834-057	4.37	2AA 008 592-021	5.223	2BA 006 091-011	1.96	2BA 010 232-021	2.06
1NL 007 906-031	1.13, 1.117, 1.120	2AA 008 592-031	5.223	2BA 006 091-021	1.96	2BA 010 232-021	2.06
1NL 007 906-041	1.13, 1.117, 1.120	2AA 008 593-001	5.223	2BA 006 386-071	1.23-1.24	2BA 010 232-021	2.06
1NL 008 090-031	1.152, 1.156, 4.26	2AA 008 593-011	5.223	2BA 006 386-081	1.23-1.24	2BA 010 232-021	2.06
1NL 008 090-037	4.26	2AA 008 593-021	5.223	2BA 006 728-801	1.146, 1.161	2BA 010 232-021	2.06
1NL 008 090-117	4.26	2AA 008 593-031	5.223	2BA 006 749-051	1.52-1.53, 2.04	2BA 010 232-021	2.06
1NL 008 090-301	4.27	2AA 008 594-001	5.223	2BA 006 749-061	1.52-1.53, 2.04	2BA 010 232-021	2.06
1NL 008 090-317	4.27	2AA 008 594-011	5.223	2BA 006 749-071	1.52, 2.03	2BA 010 232-021	2.06
1NL 008 090-327	4.27	2AA 008 594-021	5.223	2BA 006 749-081	1.52, 2.03	2BA 010 232-021	2.06
1NL 008 090-821	4.26	2AA 008 594-031	5.223	2BA 007 016-031	2.10	2BA 010 232-021	2.06
1NL 008 383-821	1.152	2AA 008 595-001	5.223	2BA 007 016-041	2.10	2BA 010 232-021	2.06
1NL 008 383-911	1.156	2AA 008 595-011	5.223	2BA 007 042-031	1.06	2BA 010 232-021	2.06
1NL 009 034-011	1.167	2AA 008 595-021	5.223	2BA 007 042-041	1.06	2BA 010 232-021	2.06
1NL 009 034-021	1.167	2AA 008 595-031	5.223	2BA 007 135-001	5.179	2BA 010 232-021	2.06
1PE...		2AB...		2BA 007 135-011	5.179	2BA 010 232-021	2.06
1PE 965 410-111	3.07	2AB 001 208-001	5.215	2BA 007 135-021	5.179	2BA 010 232-021	2.06
1PE 965 410-121	3.07	2AB 004 074-027	5.215	2BA 007 177-011	1.148	2BA 010 232-021	2.06
1PE 965 410-131	3.04, 3.06	2AB 004 074-087	5.215	2BA 007 177-021	1.148	2BA 010 232-021	2.06
1PE 965 410-141	3.04, 3.06	2AB 004 532-001	5.213	2BA 007 177-801	1.148	2BA 010 232-021	2.06
1S0...		2AB 004 532-011	5.213	2BA 007 249-011	1.97	2BA 010 232-021	2.06
1S0 001 430-011	4.45	2AB 004 532-021	5.213	2BA 007 249-021	1.97	2BA 010 232-021	2.06
1S3...		2AB 004 532-031	5.213	2BA 007 275-011	1.27	2BA 010 232-021	2.06
1S3 001 117-041	4.45	2AB 004 532-051	3.51, 3.53, 5.213	2BA 007 275-021	1.27	2BA 010 232-021	2.06
1S5...		2AB 004 532-057	5.213	2BA 007 775-051	2.12	2BA 010 232-021	2.06
1S5 003 178-431	4.46	2AB 004 532-061	5.213	2BA 007 775-061	2.12	2BA 010 232-021	2.06
1TA...		2AB 004 532-257	5.213	2BA 007 839-001	3.23, 3.25	2BA 010 232-021	2.06
1TA 003 570-001	4.44	2AB 004 532-267	5.213	2BA 007 840-001	3.31, 3.33	2BA 010 232-021	2.06
1TA 003 570-101	4.46	2BA...		2BA 007 924-071	1.183, 1.185	2BA 010 232-021	2.06
1TA 122 718-001	4.44	2BA 001 221-031	5.176	2BA 007 924-081	1.183, 1.185	2BA 010 232-021	2.06
1TA 122 718-021	4.46	2BA 001 221-041	5.176	2BA 008 221-001	5.00	2BA 010 232-021	2.06
1VB...		2BA 001 227-201	5.174	2BA 008 221-007	5.00	2BA 010 232-021	2.06
1VB 005 444-037	4.40, 4.42	2BA 001 227-211	5.174	2BA 008 221-041	1.92, 1.132, 5.00	2BA 010 232-021	2.06
1X0...		2BA 001 234-251	3.47	2BA 008 221-047	5.00	2BA 010 232-021	2.06
1X0 001 515-021	4.45	2BA 001 234-261	3.47	2BA 008 221-107	5.00	2BA 010 232-021	2.06
1ZL...		2BA 001 236-001	5.180	2BA 008 221-147	5.00	2BA 010 232-021	2.06
1ZL 010 417-431	1.123, 1.128, 2.24	2BA 001 240-301	5.00	2BA 008 221-217	5.00	2BA 010 232-021	2.06
1ZL 010 417-441	1.123, 1.128, 2.24	2BA 001 244-001	5.176	2BA 008 260-001	5.178	2BA 010 232-021	2.06
1ZL 010 541-071	1.66	2BA 001 248-001	5.174	2BA 008 260-007	5.178	2BA 010 232-021	2.06
1ZL 010 541-081	1.66	2BA 001 259-611	5.00	2BA 008 260-017	5.178	2BA 010 232-021	2.06
1ZS...		2BA 001 259-618	3.47, 5.00	2BA 008 404-011	1.30	2BA 010 232-021	2.06
1ZS 009 902-531	1.159	2BA 001 263-001	5.180	2BA 008 404-021	1.30	2BA 010 232-021	2.06
1ZS 009 902-541	1.159	2BA 001 275-011	2.08, 3.50	2BA 008 404-031	1.30	2BA 010 232-021	2.06
1ZS 010 131-631	1.45	2BA 001 275-021	2.08, 3.50	2BA 008 404-041	1.30	2BA 010 232-021	2.06
1ZS 010 131-641	1.45	2BA 001 277-011	5.176	2BA 008 805-051	5.111	2BA 010 232-021	2.06
1ZS 169 009-131	1.41	2BA 001 277-021	5.176	2BA 008 805-057	5.111	2BA 010 232-021	2.06
1ZS 169 009-141	1.41	2BA 001 416-011	5.177	2BA 008 805-187	5.111	2BA 010 232-021	2.06
1ZS 247 047-351	1.130	2BA 001 416-021	5.177	2BA 008 982-041	5.110	2BA 010 232-021	2.06
1ZS 247 047-361	1.130	2BA 001 423-087	5.00	2BA 008 982-047	5.110	2BA 010 232-021	2.06
1ZS 263 064-531	1.83	2BA 002 324-001	5.176	2BA 008 982-217	5.109	2BA 010 232-021	2.06
		2BA 002 324-011	3.52, 5.176	2BA 008 982-341	5.110	2BA 010 232	

List of Part Numbers



Part number	Page	Part number	Page	Part number	Page	Part number	Page
2BE...		2DA...		2JA...		2JA...	
2BE 343 130-667	5.00	2DA 008 136-027	5.171	2JA 007 373-011	5.211	2JA 344 170-031	5.201
2BE 343 130-777	5.00	2DA 008 136-031	5.171	2JA 007 373-031	5.211	2JA 344 170-101	5.201
2BE 343 130-787	5.00	2DA 008 221-167	5.00	2JA 007 373-041	5.211	2JA 344 170-111	5.201
2BE 344 130-777	5.00	2DA 008 805-011	5.111	2JA 007 373-061	5.211	2JA 344 170-121	5.201
2BE 959 932-131	5.178	2DA 008 805-017	5.111	2JA 007 373-071	5.211	2JA 344 170-131	5.201
2BE 964 169-071	5.00	2DA 009 001-051	5.00	2JA 007 373-107	5.211	2JA 344 170-201	5.201
2BE 964 169-077	5.00	2DA 009 001-057	5.00	2JA 007 373-117	5.211	2JA 344 190-001	5.195
2BE 980 690-101	5.184	2DA 009 001-147	5.00	2JA 007 373-127	5.211	2JA 344 190-011	5.195
2BE 996 029-021	5.185	2DA 010 415-001	1.157-1.158, 1.161, 1.168, 1.176	2JA 007 373-137	5.211	2JA 344 190-021	5.195
2BE 997 006-101	5.00			2JA 007 373-151	5.209	2JA 344 190-101	5.196
2BE 997 131-081	5.00	2DA 343 106-001	5.172	2JA 007 373-157	5.209	2JA 344 190-111	5.196
2BE 997 131-207	5.00	2DA 343 106-007	5.172	2JA 007 373-161	5.209	2JA 344 190-121	5.196
2BM...		2DA 343 106-011	5.172	2JA 007 373-177	5.210	2JA 344 190-201	5.196
2BM 001 313-001	5.182	2DA 343 106-017	5.172	2JA 007 373-187	5.210	2JA 344 190-211	5.196
2BM 001 313-002	5.182	2DA 343 106-021	5.172	2JA 007 373-197	5.209	2JA 344 190-221	5.196
2BM 001 313-821	5.182	2DA 343 106-027	5.172	2JA 008 078-031	5.205	2JA 344 190-301	5.196
2BM 001 318-001	5.182	2DA 343 106-031	5.172	2JA 008 405-081	5.203	2JA 344 190-311	5.196
2BM 002 652-031	5.175	2DA 343 106-037	5.172	2JA 008 615-001	5.203	2JA 344 190-321	5.196
2BM 002 652-051	2.14-2.15, 3.55, 5.175	2DA 343 106-201	5.172	2JA 009 037-017	5.187	2JA 344 190-351	5.196
		2DA 343 106-207	5.172	2JA 009 037-027	5.187	2JA 344 190-361	5.196
		2DA 343 106-211	5.172	2JA 009 208-001	5.203	2JA 344 190-371	5.196
2BM 002 652-071	2.15, 3.55	2DA 343 106-217	5.172	2JA 009 208-011	5.203	2JA 344 199-001	5.197
2BM 002 652-081	2.15, 3.55	2DA 343 106-221	5.172	2JA 009 294-001	5.202	2JA 344 199-011	5.197
2BM 002 847-011	3.62, 5.182	2DA 343 106-227	5.172	2JA 009 294-021	5.202	2JA 344 199-021	5.197
2BM 002 847-021	3.62, 5.182	2DA 343 106-231	5.172	2JA 009 294-241	5.202	2JA 344 199-101	5.198
2BM 003 563-111	1.91, 1.96-1.97, 1.99, 1.130-1.131, 1.135, 1.137, 2.17, 2.19, 5.181	2DA 343 106-237	5.172	2JA 009 294-261	5.202	2JA 344 199-111	5.198
		2DA 343 130-257	5.00	2JA 010 838-017	5.206	2JA 344 199-121	5.198
		2DA 343 130-267	5.00	2JA 340 111-001	5.209	2JA 344 199-201	5.198
2BM 003 563-217	5.181	2DA 343 800-001	5.172	2JA 343 570-001	5.202	2JA 344 199-211	5.198
2BM 003 647-021	1.11, 1.18-1.22, 1.24-1.25, 1.143, 1.145-1.146, 1.162, 1.168-1.169, 2.30, 5.181	2DA 343 800-007	5.172	2JA 343 570-011	5.202	2JA 344 199-221	5.198
		2DA 343 800-047	5.172	2JA 343 570-021	5.202	2JA 344 199-301	5.198
		2DA 343 800-057	5.172	2JA 343 570-031	5.202	2JA 344 199-311	5.198
2BM 003 647-067	5.181	2DA 344 130-607	5.00	2JA 343 570-041	5.202	2JA 344 199-321	5.198
2BM 003 647-801	1.143, 1.145-1.146, 1.162, 1.169, 2.30, 5.181	2DA 344 130-617	5.00	2JA 343 570-051	5.202	2JA 344 199-351	5.198
		2DA 959 071-037	5.171	2JA 343 570-061	5.202	2JA 344 199-361	5.198
		2DA 959 071-237	5.171	2JA 343 570-071	5.202	2JA 344 199-371	5.198
2BM 003 933-031	1.27, 1.33, 1.45-1.46, 5.182	2DA 959 071-537	5.171	2JA 343 570-117	5.202	2JA 344 590-001	5.199
		2DA 959 071-737	5.171	2JA 343 570-141	5.202	2JA 344 590-011	5.199
		2DA 959 071-757	5.171	2JA 343 570-157	5.202	2JA 344 590-021	5.199
2BM 003 933-041	1.27, 1.33, 1.45-1.46, 5.182	2DA 959 380-111	5.170	2JA 343 606-001	5.205	2JA 344 590-101	5.199
		2DA 959 380-511	5.171	2JA 343 606-007	5.205	2JA 344 590-111	5.199
		2DA 959 580-151	5.171	2JA 343 606-011	5.205	2JA 344 590-121	5.199
2BM 004 312-051	3.57, 5.181	2DA 959 580-551	5.171	2JA 343 606-017	5.205	2JA 344 599-001	5.200
2BM 004 312-061	3.57, 5.181	2DA 964 169-001	5.00	2JA 343 606-201	5.205	2JA 344 599-011	5.200
2BM 004 965-801	5.181	2DA 964 169-007	5.00	2JA 343 606-217	5.205	2JA 344 599-021	5.200
2BM 006 692-011	2.10, 2.12, 2.14-2.15, 3.23, 3.38, 3.51, 3.56-3.57, 3.68, 5.183	2DA 964 169-727	5.00	2JA 343 660-021	5.204	2JA 344 599-101	5.200
		2DA 965 039-011	5.00	2JA 343 660-101	5.204	2JA 344 599-111	5.200
		2DA 965 039-091	5.00	2JA 343 660-107	5.204	2JA 344 599-121	5.200
		2DA 965 039-317	5.00	2JA 343 660-117	5.204	2JA 344 599-201	5.200
		2DA 996 012-041	5.104	2JA 343 680-067	5.190	2JA 344 599-211	5.200
		2DA 997 027-021	5.118	2JA 343 680-127	5.190	2JA 344 599-221	5.200
2BM 006 692-017	5.183	2DB...		2JA 343 680-177	5.190	2JA 344 599-301	5.200
2BM 006 692-021	2.10, 2.12, 2.14-2.15, 3.23, 3.38, 3.51, 3.56-3.57, 3.68, 5.183	2DB 004 431-061	5.108	2JA 343 700-051	5.189	2JA 344 599-311	5.200
		2JA...		2JA 343 700-167	5.189	2JA 344 599-321	5.200
2BM 006 692-027	5.183	2JA 001 330-001	5.205	2JA 343 700-221	5.189	2JA 344 599-351	5.200
2BM 006 759-001	1.143, 1.145-1.146, 1.162, 1.169, 2.31	2JA 001 330-007	5.205	2JA 343 700-251	5.189	2JA 344 599-361	5.200
		2JA 001 330-031	5.205	2JA 343 700-271	5.189	2JA 344 599-371	5.200
2BM 008 355-001	5.183	2JA 001 331-011	5.207	2JA 343 720-011	5.214	2JA 959 037-511	5.00
2BM 008 355-007	5.183	2JA 001 335-011	5.208	2JA 343 720-021	5.214	2JA 959 073-001	5.186
2BM 008 355-017	5.183	2JA 001 346-011	5.205	2JA 343 720-071	5.214	2JA 959 073-201	5.186
2BM 008 771-001	5.183	2JA 001 357-002	2.09, 2.16, 3.15, 3.17, 3.48-3.49, 3.51, 3.55-3.56, 3.59, 5.186	2JA 343 720-081	5.214	2JA 959 599-002	5.220
2BM 008 771-007	5.183			2JA 343 720-091	5.214	2JA 959 599-102	5.220
2BM 009 320-807	5.181	2JA 001 357-012	2.09, 2.12, 2.15-2.16, 3.15, 3.17, 3.48-3.49, 3.51, 3.55-3.56, 3.59, 3.65, 5.186	2JA 343 720-111	5.214	2JA 959 820-501	5.00
2BM 964 295-041	5.131			2JA 343 720-121	5.214	2JA 959 950-017	5.00
2BM 964 169-047	5.131			2JA 343 720-157	5.214	2JA 959 950-031	5.00
2BN...				2JA 343 720-191	5.214	2JA 959 950-041	5.00
2BN 344 169-097	5.00			2JA 343 720-291	5.214	2JA 964 916-001	5.188
2BN 344 169-107	5.00	2JA 001 360-001	5.206	2JA 343 720-511	5.214	2JA 964 916-011	5.188
2BN 964 169-051	5.00	2JA 001 364-001	5.206	2JA 343 720-521	5.214	2JA 980 596-002	5.221
2BN 964 169-057	5.00	2JA 002 532-011	1.145	2JA 343 720-531	5.214	2JA 980 596-102	5.221
2BN 964 169-247	5.00	2JA 002 661-001	3.65, 5.186	2JA 343 720-611	5.214	2JA 996 038-001	5.186
2BN 964 169-777	5.00	2JA 002 811-027	5.186	2JA 343 720-621	5.214	2JA 997 027-051	5.118, 5.205
2BN 964 169-787	5.00	2JA 002 931-031	1.20, 1.22, 1.169, 1.179, 2.30, 2.33	2JA 343 720-631	5.214	2JA 998 560-017	5.201
2DA...				2JA 343 790-107	5.193	2JA 998 560-057	5.201
2DA 001 240-341	5.00	2JA 003 115-001	1.87	2JA 343 790-301	5.192	2JA 998 565-032	5.209
2DA 001 423-077	5.00	2JA 003 231-001	5.208	2JA 343 790-311	5.192	2JA 998 569-017	5.208
2DA 003 014-031	5.102	2JA 003 231-011	5.208	2JA 343 790-341	5.192		
2DA 003 014-037	5.102	2JA 003 232-001	5.208	2JA 343 790-401	5.192	2JB...	
2DA 003 236-031	5.105	2JA 003 232-011	5.208	2JA 343 790-411	5.192	2JB 343 227-041	5.203
2DA 003 236-037	5.105	2JA 003 232-017	5.208	2JA 343 790-601	5.192	2JB 343 227-047	5.203
2DA 003 236-331	5.106	2JA 003 236-357	5.188	2JA 343 790-611	5.192	2JB 996 012-121	5.104
2DA 003 734-011	5.114	2JA 003 354-001	5.207	2JA 343 790-641	5.192		
2DA 005 200-321	5.107	2JA 003 354-031	5.207	2JA 343 790-701	5.192	2KA...	
2DA 005 603-031	5.112	2JA 003 388-001	1.28	2JA 343 790-711	5.192	2KA 001 378-001	5.153
2DA 005 603-037	5.112	2JA 004 192-001	5.206	2JA 343 790-741	5.192	2KA 001 378-041	2.09, 3.50, 5.153
2DA 005 603-237	5.112	2JA 004 252-031	1.86-1.87	2JA 343 795-001	5.193	2KA 001 378-127	5.153
2DA 005 739-111	5.170	2JA 004 531-001	5.209	2JA 343 795-011	5.193	2KA 001 378-207	5.153
2DA 005 739-117	5.170	2JA 004 531-011	5.209	2JA 343 860-031	5.190	2KA 001 386-231	3.18, 5.157
2DA 007 421-001	5.170	2JA 005 590-001	5.204	2JA 343 865-031	5.190	2KA 001 386-241	5.157
2DA 007 421-007	5.170	2JA 005 590-157	5.204	2JA 343 980-217	5.193	2KA 001 386-281	5.157
2DA 007 421-017	5.170	2JA 006 447-041	5.187	2JA 343 985-001	5.194	2KA 001 386-291	5.157
2DA 007 421-027	5.170	2JA 006 447-087	5.187	2JA 343 985-011	5.194	2KA 001 386-301	5.157
2DA 007 428-001	5.169	2JA 006 447-251	5.187	2JA 343 985-041	5.194	2KA 001 386-497	5.157
2DA 007 428-007	5.169</						



List of Part Numbers

Part number	Page	Part number	Page	Part number	Page	Part number	Page
2KA...		2NE...		2PF...		2PS...	
2KA 003 389-011	5.136	2NE 354 542-041	1.15, 1.17	2PF 962 964-071	5.116	2PS 008 645-601	5.128
2KA 003 389-061	2.09, 2.12, 2.16, 3.51, 3.53, 3.56, 3.75, 5.136	2NE 959 011-501	5.00	2PF 964 295-021	5.132	2PS 008 645-607	5.128
2KA 003 389-062	5.136	2NE 959 011-507	5.00	2PF 964 295-027	5.132	2PS 008 645-611	5.128
2KA 003 389-068	5.136	2NE 959 821-201	5.00	2PF 964 295-257	5.132	2PS 008 645-617	5.128
2KA 003 389-081	3.20, 3.22, 3.24, 3.29, 3.31, 3.34, 3.36, 3.38, 5.136	2NE 964 169-021	5.00	2PF 965 039-071	5.00	2PS 008 645-621	5.128
2KA 003 389-211	5.136	2NE 964 169-027	5.00	2PF 965 039-077	5.00	2PS 008 645-627	5.128
2KA 003 389-217	5.136	2NE 964 169-227	5.00	2PF 965 039-151	5.00	2PS 008 645-981	5.128
2KA 003 389-398	5.136	2NE 964 169-341	5.00	2PF 996 012-051	5.104	2PS 008 645-991	5.128
2KA 003 485-021	1.96, 1.130, 1.135, 1.137	2NE 964 169-521	5.00	2PF 996 112-031	5.146	2PS 009 226-017	5.139
2KA 003 738-057	5.153	2NE 964 169-527	5.00	2PF 997 022-011	5.142	2PS 009 226-021	5.139
2KA 004 331-031	1.27, 1.33, 1.45-1.46	2NE 964 169-667	5.00	2PF 997 023-011	5.142	2PS 009 226-027	5.139
2KA 004 331-061	5.153	2NE 964 962-041	1.161	2PF 997 027-011	5.118	2PS 009 226-037	5.139
2KA 004 331-067	5.153	2NE 965 039-031	5.00	2PG...		2PS 009 226-067	5.139
2KA 004 331-107	5.153	2NE 965 039-037	5.00	2PG 002 727-021	5.121	2PS 340 000-001	5.125
2KA 004 434-031	1.96, 1.130, 2.19	2NE 965 039-111	5.00	2PG 003 057-011	5.100	2PS 340 000-011	5.125
2KA 004 525-001	5.156	2NE 965 039-117	5.00	2PG 003 057-067	5.100	2PS 340 000-021	5.125
2KA 004 983-011	1.69, 1.73, 1.86, 1.88	2NE 965 039-327	5.00	2PG 003 748-151	5.119	2PS 340 000-041	5.125
2KA 005 049-008	5.153	2NE 996 012-021	5.104	2PG 004 361-011	5.121	2PS 340 000-051	5.125
2KA 005 049-011	5.153	2NR...		2PG 004 361-017	5.121	2PS 340 000-171	5.125
2KA 005 049-017	5.153	2NR 005 190-071	1.22	2PG 006 717-021	5.117	2PS 340 001-001	5.123
2KA 006 896-001	5.155	2NR 005 554-111	1.34	2PG 006 717-022	5.117	2PS 343 690-001	5.130
2KA 006 896-007	5.155	2NR 005 554-121	1.34	2PG 006 717-027	5.117	2PS 343 690-007	5.130
2KA 007 929-001	5.157	2NR 009 247-121	1.144	2PG 008 434-001	5.145	2PS 343 690-011	5.130
2KA 007 929-007	5.157	2NR 009 247-161	1.144	2PG 008 645-167	5.127	2PS 343 690-017	5.130
2KA 010 278-011	5.154	2NR 010 229-011	1.62	2PG 008 645-561	5.127	2PS 343 690-027	5.130
2KA 010 278-017	5.154	2NR 010 229-021	1.62	2PG 008 645-567	5.127	2PS 343 690-031	5.130
2KA 010 278-021	5.154	2NR 982 008-111	1.51	2PG 008 645-631	5.127	2PS 343 690-037	5.130
2KA 010 278-027	5.154	2NR 982 008-121	1.51	2PG 008 645-641	5.127	2PS 343 690-047	5.130
2KA 010 278-031	5.154	2PF...		2PG 008 645-917	5.127	2PS 343 690-057	5.130
2KA 010 278-037	5.154	2PF 001 259-631	3.47, 5.00	2PG 008 645-961	5.127	2PS 343 690-061	5.130
2KA 010 278-041	5.154	2PF 001 259-677	3.47, 5.00	2PG 008 645-967	5.127	2PS 343 690-067	5.130
2KA 010 278-047	5.154	2PF 001 259-687	3.47	2PG 008 645-971	5.127	2PS 343 690-201	5.130
2KA 010 278-051	5.154	2PF 001 634-101	5.142	2PG 008 645-977	5.127	2PS 343 690-207	5.130
2KA 010 278-057	5.154	2PF 001 634-101	3.47, 5.144	2PG 340 000-121	5.125	2PS 343 690-227	5.130
2KA 010 278-111	5.154	2PF 001 638-067	3.47	2PG 343 690-107	5.129	2PS 343 690-237	5.130
2KA 010 278-121	5.154	2PF 001 647-031	3.47, 5.141	2PG 343 690-117	5.129	2PS 343 690-407	5.130
2KA 010 278-127	5.154	2PF 001 647-037	5.141	2PG 343 690-301	5.129	2PS 343 690-411	5.130
2KA 010 278-311	5.154	2PF 001 648-161	5.146	2PG 343 690-307	5.129	2PS 343 690-417	5.130
2KA 010 278-317	5.154	2PF 001 648-171	5.146	2PG 343 690-317	5.129	2PS 343 690-427	5.130
2KA 010 278-321	5.154	2PF 001 650-001	5.146	2PG 962 964-041	5.116	2PS 343 690-607	5.130
2KA 010 278-327	5.154	2PF 002 860-031	3.52	2PG 962 964-051	5.116	2PS 343 690-617	5.130
2KA 010 278-411	5.154	2PF 003 014-071	5.103	2PG 962 964-057	5.116	2PS 343 690-627	5.130
2KA 010 278-421	5.154	2PF 003 014-301	5.103	2PG 963 639-401	5.122	2PS 962 964-012	5.116
2KA 959 640-102	5.135	2PF 003 057-001	5.100	2PG 963 639-411	5.122	2PS 962 964-018	5.116
2KA 959 640-607	5.135	2PF 003 057-002	5.100	2PF 003 959-021	5.120	2PS 962 964-031	5.116
2KA 997 011-001	5.155	2PF 003 057-007	5.100	2PG 963 959-027	5.120	2PS 962 964-037	5.116
2KA 997 011-011	5.155	2PF 003 057-041	5.100	2PF 964 295-011	5.132	2PS 963 639-001	5.122
2KA 997 011-021	5.155	2PF 003 389-037	5.137	2PG 964 295-017	5.132	2PS 963 639-007	5.122
2KA 997 122-001	5.154	2PF 003 389-041	5.137	2PG 964 295-111	5.132	2PS 963 639-011	5.122
2KA 998 523-001	5.156	2PF 003 563-151	5.145	2PG 964 295-117	5.132	2PS 963 639-017	5.122
2KA 998 523-007	5.156	2PF 003 563-177	5.145	2PG 964 295-121	5.132	2PS 963 639-021	5.124
2KA 998 523-117	5.156	2PF 003 563-187	5.145	2PG 964 295-127	5.132	2PS 963 639-027	5.124
2NE...		2PF 003 734-031	5.115	2PG 964 295-337	5.132	2PS 963 639-031	5.124
2NE 001 423-011	5.00	2PF 004 081-001	5.101	2PS...		2PS 963 639-037	5.124
2NE 002 589-001	2.09, 3.50, 5.164	2PF 004 081-007	5.101	2PS 002 727-001	5.121	2PS 963 639-041	5.124
2NE 002 589-007	1.81, 1.103	2PF 004 081-017	5.101	2PS 003 057-051	5.100	2PS 963 639-047	5.124
2NE 002 985-001	5.163	2PF 004 081-107	5.101	2PS 003 057-052	5.100	2PS 963 639-051	5.124
2NE 003 030-151	5.163	2PF 006 679-007	5.142	2PS 003 057-057	5.100	2PS 963 639-057	5.124
2NE 003 030-167	5.163	2PF 006 717-011	5.117	2PS 003 748-121	5.119	2PS 963 639-061	5.122
2NE 003 236-001	3.20, 3.49, 3.52, 3.54, 3.59, 3.64, 5.105	2PF 007 205-001	5.145	2PS 003 748-127	5.119	2PS 963 639-067	5.122
2NE 003 236-008	5.105	2PF 007 205-007	5.145	2PS 003 748-161	5.119	2PS 963 639-071	5.122
2NE 003 236-301	5.106	2PF 007 205-017	5.145	2PS 003 748-167	5.119	2PS 963 639-077	5.122
2NE 003 236-307	5.106	2PF 008 221-011	5.00	2PS 003 748-177	5.119	2PS 963 639-081	5.124
2NE 003 315-011	5.164	2PF 008 221-017	5.00	2PS 004 361-001	5.121	2PS 963 639-091	5.124
2NE 003 734-091	5.114	2PF 008 221-177	5.00	2PS 004 361-007	5.121	2PS 963 639-097	5.124
2NE 004 432-011	5.109	2PF 008 405-051	5.00	2PS 006 717-031	5.117	2PS 963 639-101	5.124
2NE 005 603-071	5.112	2PF 008 405-057	5.00	2PS 006 717-032	5.117	2PS 963 639-107	5.124
2NE 005 603-077	5.112	2PF 008 405-061	5.203, 5.00	2PS 006 717-037	5.117	2PS 963 639-117	5.124
2NE 006 609-001	5.165	2PF 008 405-067	5.00	2PS 006 717-051	5.117	2PS 963 639-127	5.122
2NE 006 609-007	5.165	2PF 008 405-127	5.00	2PS 006 717-057	5.117	2PS 963 639-137	5.122
2NE 006 609-011	5.165	2PF 009 001-081	5.00	2PS 006 717-061	5.117	2PS 963 639-147	5.122
2NE 006 609-017	5.165	2PF 009 001-177	5.00	2PS 006 717-067	5.117	2PS 963 639-157	5.122
2NE 006 609-187	5.165	2PF 009 001-421	5.00	2PS 006 717-071	5.117	2PS 963 639-167	5.122
2NE 008 221-031	1.92, 1.132, 5.00	2PF 009 001-521	5.00	2PS 007 943-011	5.138	2PS 963 639-177	5.122
2NE 008 221-037	5.00	2PF 009 514-001	5.141	2PS 007 943-017	5.138	2PS 963 639-197	5.122
2NE 008 221-137	5.00	2PF 009 514-011	5.141	2PS 007 943-021	5.138	2PS 963 639-207	5.122
2NE 008 805-031	5.111	2PF 340 000-111	5.125	2PS 007 943-027	5.138	2PS 963 959-001	5.120
2NE 008 805-037	5.111	2PF 959 570-202	5.143	2PS 007 943-027	5.138	2PS 963 959-007	5.120
2NE 009 001-021	5.00	2PF 959 570-207	5.143	2PS 007 943-311	5.138	2PS 963 959-011	5.120
2NE 009 001-027	5.00	2PF 959 570-212	5.143	2PS 007 943-317	5.138	2PS 963 959-017	5.120
2NE 009 001-127	5.00	2PF 959 570-217	5.143	2PS 007 943-321	5.138	2PS 964 295-001	5.131
2NE 343 130-031	5.00	2PF 959 570-401	5.143	2PS 007 972-011	5.138	2PS 964 295-007	5.131
2NE 343 130-037	5.00	2PF 959 570-407	5.143	2PS 007 972-017	5.138	2PS 964 295-051	5.131
2NE 343 130-177	5.00	2PF 959 570-411	5.143	2PS 008 138-001	5.139	2PS 964 295-057	5.131
2NE 343 130-277	5.00	2PF 959 570-417	5.143	2PS 008 138-101	5.139	2PS 964 295-061	5.131
2NE 343 130-287	5.00	2PF 959 570-427	5.143	2PS 008 138-111	5.139	2PS 964 295-067	5.131
2NE 344 169-047	5.00	2PF 959 590-202	5.134	2PS 008 138-801	5.139	2PS 964 295-071	5.131
2NE 344 169-067	5.00	2PF 959 590-207	5.134	2PS 008 138-811	5.139	2PS 964 295-077	5.131
2NE 344 169-117	5.00	2PF 959 590-212	5.134	2PS 008 138-821	5.139	2PS 964 295-081	5.131
2NE 344 200-061	5.00	2PF 959 590-217	5.134	2PS 008 382-001	5.140	2PS 964 295-347	5.131
2NE 344 200-067	5.00	2PF 959 590-218	5.134	2PS 008 382-007	5.140	2PS 964 295-357	5.131
2NE 344 200-091	5.00	2PF 959 590-237	5.134	2PS 008 382-801			

List of Part Numbers



Part number	Page	Part number	Page	Part number	Page	Part number	Page
2PT...		2RL...		2RL...		2SB...	
2PT 009 305-821	1,93, 1.133, 2.18, 2.26	2RL 008 062-101	6.10	2RL 010 743-101	6.31	2SB 343 130-757	5.00
2PT 009 496-007	5.152	2RL 008 062-111	6.10	2RL 010 743-111	6.31	2SB 343 130-767	5.00
2PT 009 496-801	5.152	2RL 008 063-001	6.11	2RL 010 743-121	6.31	2SB 343 390-091	5.00
2PT 009 599-011	1.59, 1.156, 5.150	2RL 008 063-011	6.11	2RL 010 743-131	6.31	2SB 344 169-017	5.00
2PT 009 599-021	1.59, 1.156, 5.150	2RL 008 063-101	6.11	2RL 010 743-141	6.31	2SB 344 200-027	5.00
2PT 009 599-031	5.150	2RL 008 064-001	6.12	2RL 010 743-151	6.31	2SB 344 200-081	5.00
2PT 009 599-041	5.150	2RL 008 064-101	6.12	2RL 010 979-001	6.19	2SB 344 200-087	5.00
2PT 009 599-801	5.150	2RL 008 065-001	6.13	2RL 010 979-011	6.19	2SB 344 200-221	5.00
2PT 010 043-011	5.151	2RL 008 065-011	6.13	2RL 010 979-021	6.19	2SB 344 200-227	5.00
2PT 010 043-021	5.151	2RL 008 065-101	6.13	2RL 171 067-101	6.50	2SB 344 200-231	5.00
2PT 010 043-031	5.151	2RL 008 065-107	6.13	2RL 863 106-001	6.38, 6.43, 6.50	2SB 344 200-237	5.00
2PT 010 043-041	5.151	2RL 008 065-111	6.13	2RL 863 106-011	6.38, 6.43, 6.50	2SB 344 200-321	5.00
2PT 010 043-801	5.151	2RL 008 065-101	6.13	2RL 863 123-001	6.38, 6.50	2SB 344 200-327	5.00
2PT 010 043-811	2.03, 2.20	2RL 008 181-001	6.16	2RL 863 123-011	6.38, 6.50	2SB 344 200-331	5.00
2PT 010 047-201	5.147	2RL 008 181-011	6.16	2RL 863 132-001	6.50	2SB 344 200-337	5.00
2PT 010 047-211	5.147	2RL 008 181-101	6.16	2RL 863 132-011	6.50	2SB 959 010-301	5.00
2PT 010 047-821	5.147	2RL 008 181-111	6.16	2RL 863 132-021	6.38	2SB 959 010-307	5.00
2PT 010 177-801	1.156	2RL 008 182-001	6.17	2RL 863 132-031	6.38	2SB 959 821-601	5.00
2PT 010 177-811	1.59	2RL 008 182-011	6.17			2SB 964 169-287	5.00
2PT 010 458-801	1.60, 1.157, 5.148	2RL 008 182-101	6.17	2RM...		2SB 964 169-301	5.00
2PT 010 458-811	1.60, 1.157, 5.148	2RL 008 182-111	6.17	2RM 010 700-...	6.47-6.48	2SB 964 169-307	5.00
2PT 010 458-821	5.148	2RL 008 183-001	6.17	2RM 010 701-...	6.48-6.49	2SB 964 169-531	5.00
2PT 010 458-831	5.148	2RL 008 183-011	6.17	2RM 379 500-...	6.50	2SB 964 169-537	5.00
2PT 010 458-841	5.149	2RL 008 183-101	6.17	2RM 379 501-...	6.50	2SB 964 169-677	5.00
2PT 010 458-851	5.149	2RL 008 183-111	6.17			2SB 964 169-717	5.00
2PT 010 458-861	5.149	2RL 008 364-021	6.09, 6.59	2SA...		2SB 965 039-051	5.00
2PT 010 458-961	5.149	2RL 008 366-021	6.16, 6.59	2SA 001 240-331	5.00	2SB 965 039-057	5.00
2PT 010 458-971	5.149	2RL 008 366-031	6.16, 6.59	2SA 001 259-751	5.00	2SB 965 039-131	5.00
2PT 177 696-801	5.148	2RL 008 965-001	6.05	2SA 001 259-757	3.47, 5.00	2SB 965 039-137	5.00
2PT 177 696-811	5.148	2RL 008 965-011	6.05	2SA 001 634-121	5.142	2SB 980 606-201	5.00
2PT 177 696-821	5.148	2RL 008 965-021	6.05	2SA 001 638-021	3.47, 5.144	2SB 980 606-701	5.00
2PT 177 696-831	5.148	2RL 008 965-031	6.05	2SA 001 647-041	5.141		
2PT 177 696-841	5.149	2RL 008 965-041	6.05	2SA 002 860-041	3.52	2SD...	
2PT 177 696-851	5.149	2RL 008 966-001	6.06	2SA 003 014-051	5.102	2SD 001 305-021	5.00
2PT 177 696-861	5.149	2RL 008 966-021	6.06	2SA 003 057-021	5.100	2SD 001 306-061	5.00
2PT 177 696-871	5.149	2RL 008 966-031	6.06	2SA 003 236-041	5.105	2SD 001 679-001	5.00
2PT 965 039-171	5.00	2RL 008 967-001	6.06	2SA 003 236-047	5.105	2SD 001 680-271	2.08, 2.14, 5.00
2PT 965 039-177	5.00	2RL 008 967-011	6.06	2SA 003 236-048	5.105	2SD 001 680-281	2.08, 5.00
2PT 980 680-101	5.151	2RL 008 967-021	6.06	2SA 003 236-341	5.106	2SD 001 680-391	5.00
2PT 980 680-601	5.151	2RL 008 967-031	6.06	2SA 003 236-341	5.114	2SD 001 680-401	5.00
2PT 980 680-821	5.151	2RL 008 967-041	6.06	2SA 004 431-071	5.108	2SD 001 685-211	3.48, 5.00
2PT 980 680-861	5.151	2RL 008 990-001	6.07	2SA 005 200-331	5.107	2SD 001 685-218	5.00
		2RL 008 990-011	6.07	2SA 005 603-021	5.112	2SD 001 685-231	5.00
		2RL 008 990-021	6.07	2SA 005 603-027	5.112	2SD 001 685-232	5.00
		2RL 009 279-...	6.38	2SA 005 603-227	5.112	2SD 001 685-277	5.00
		2RL 009 688-...	6.38	2SA 006 679-027	5.142	2SD 001 685-307	5.00
		2RL 010 710-011	6.35	2SA 006 717-001	5.117	2SD 001 685-317	5.00
		2RL 010 710-021	6.35	2SA 006 717-007	5.117	2SD 001 685-347	5.00
		2RL 010 710-031	6.35	2SA 008 221-127	5.00	2SD 001 686-101	5.00
		2RL 010 710-041	6.35	2SA 008 405-011	5.00	2SD 001 688-141	5.00
		2RL 010 710-051	6.35	2SA 008 405-017	5.00	2SD 001 688-171	5.00
		2RL 010 710-061	6.35	2SA 008 405-021	1.92, 1.132, 5.00	2SD 001 693-011	5.00
		2RL 010 710-071	6.35	2SA 008 405-027	5.00	2SD 001 699-061	3.14, 3.16, 3.18, 3.48, 3.55, 3.63, 5.00
		2RL 010 710-101	6.33	2SA 008 805-001	5.111	2SD 001 699-511	5.00
		2RL 010 710-111	6.33	2SA 008 805-007	5.111	2SD 002 514-161	5.00
		2RL 010 710-121	6.33	2SA 009 001-041	5.00	2SD 002 582-011	5.00
		2RL 010 710-131	6.33	2SA 009 001-047	5.00	2SD 002 582-017	5.00
		2RL 010 710-141	6.33	2SA 009 001-137	5.00	2SD 002 582-021	5.00
		2RL 010 710-151	6.35	2SA 961 167-011	5.141	2SD 002 582-027	5.00
		2RL 010 710-161	6.35	2SA 962 964-091	5.116	2SD 002 776-231	5.00
		2RL 010 710-171	6.35	2SA 964 169-091	5.00	2SD 002 776-237	5.00
		2RL 010 710-181	6.35	2SA 964 169-097	5.00	2SD 002 776-241	5.00
		2RL 010 710-191	6.35	2SA 964 169-277	5.00	2SD 002 776-247	5.00
		2RL 010 710-211	6.33	2SA 965 038-031	1.10	2SD 002 844-021	5.00
		2RL 010 710-221	6.33	2SA 965 038-041	1.10	2SD 002 844-031	5.00
		2RL 010 710-231	6.35	2SA 965 039-001	5.00	2SD 002 844-061	5.00
		2RL 010 710-241	6.35	2SA 965 039-007	5.00	2SD 002 844-067	5.00
		2RL 010 710-251	6.35	2SA 965 039-081	5.00	2SD 002 844-131	5.00
		2RL 010 710-261	6.35	2SA 965 039-087	5.00	2SD 003 167-011	5.00
		2RL 010 710-281	6.35	2SA 965 039-307	5.00	2SD 003 167-021	3.15, 3.17, 3.19, 3.48-3.49, 3.64, 5.00
		2RL 010 713-001	6.36	2SA 996 012-091	5.104	2SD 003 167-521	5.00
		2RL 010 713-011	6.36	2SA 997 022-001	5.142	2SD 003 167-531	3.20, 3.22, 5.00
		2RL 010 713-021	6.36	2SA 997 023-001	5.142	2SD 003 167-541	3.20, 3.22, 5.00
		2RL 010 713-031	6.36	2SA 997 027-001	5.118	2SD 003 182-051	5.00
		2RL 010 713-041	6.36			2SD 003 182-057	5.00
		2RL 010 713-051	6.36	2SB...		2SD 003 182-061	5.00
		2RL 010 713-061	6.36	2SB 001 240-311	5.00	2SD 003 182-067	5.00
		2RL 010 713-071	6.36	2SB 001 259-261	5.00	2SD 003 184-031	5.00
		2RL 010 713-081	6.36	2SB 001 301-021	5.00	2SD 003 184-037	5.00
		2RL 010 713-091	6.34	2SB 001 423-097	5.00	2SD 003 184-041	5.00
		2RL 010 713-101	6.36	2SB 001 673-002	5.00	2SD 003 184-047	5.00
		2RL 010 713-111	6.34	2SB 003 014-151	5.102	2SD 003 409-181	5.00
		2RL 010 713-121	6.36	2SB 003 018-031	5.00	2SD 003 409-201	5.00
		2RL 010 713-131	6.37	2SB 004 460-061	5.00	2SD 003 409-207	5.00
		2RL 010 713-141	6.37	2SB 005 603-137	5.112	2SD 003 409-317	5.00
		2RL 010 713-151	6.36	2SB 008 405-091	5.00	2SD 003 409-327	5.00
		2RL 010 713-161	6.34	2SB 008 405-101	5.00	2SD 004 431-011	5.108
		2RL 010 713-171	6.34	2SB 008 805-021	5.111	2SD 004 460-001	5.00
		2RL 010 713-181	6.37	2SB 008 805-027	5.111	2SD 004 460-007	5.00
		2RL 010 713-191	6.37	2SB 008 982-001	5.110	2SD 004 460-011	5.00
		2RL 010 713-201	6.37	2SB 008 982-007	5.110	2SD 004 460-017	5.00
		2RL 010 713-211	6.34	2SB 008 982-207	5.109	2SD 004 623-028	5.00
		2RL 010 713-221	6.37	2SB 008 982-301	5.110	2SD 006 040-031	5.00
		2RL 010 713-231	6.34	2SB 008 982-307	5.110	2SD 006 040-037	5.00
		2RL 010 743-001	6.31	2SB 008 982-367	5.110	2SD 006 040-041	5.00
		2RL 010 743-011	6.31	2SB 009 001-061	5.00	2SD 006 040-131	5.00
		2RL 010 743-021	6.31	2SB 009 001-067	5.00	2SD 006 040-137	5.00
		2RL 010 743-031	6.31	2SB 009 001-157	5.00	2SD 006 040-141	5.00
		2RL 010 743-041	6.31	2SB 009 001-401	5.00	2SD 006 040-147	5.00
		2RL 010 743-051	6.31	2SB 009 001-501	5.00	2SD 006 040-161	5.00
		2RL 010 743-061	6.31	2SB 009 362-011	5.00	2SD 006 040-167	5.00
		2RL 010 743-071	6.31	2SB 009 362-021	5.00	2SD 006 040-331	5.00
		2RL 010 743-081	6.31	2SB 009 362-041	5.00		
		2RL 010 743-091	6.31	2SB 343 130-027	5.00		



List of Part Numbers

Part number	Page	Part number	Page	Part number	Page	Part number	Page
2SD...		2SE...		2TA...		2VA...	
2SD 006 040-337	5.00	2SE 003 409-197	5.00	2TA 964 169-067	5.00	2VA 354 669-041	1.173
2SD 006 459-021	5.00	2SE 004 623-001	5.00, 5.00	2TA 964 169-767	5.00	2VA 354 673-011	1.101
2SD 006 459-027	5.00	2SE 004 623-007	5.00	2TA 964 169-797	5.00	2VA 354 673-021	1.101
2SD 006 459-031	5.00	2SE 006 040-011	5.00	2TF...		2VA 354 675-031	1.52
2SD 009 691-091	1.176	2SE 007 547-011	5.00	2TF 001 259-761	5.00	2VA 354 675-041	1.52
2SD 009 691-101	1.176	2SE 007 547-017	5.00	2TJ...		2VA 964 957-011	1.175
2SD 010 230-011	1.61	2SE 007 547-021	5.00	2TJ 001 633-211	5.144	2VA 964 957-021	1.175
2SD 010 230-021	1.61	2SE 007 547-027	5.00	2TJ 003 168-151	3.58, 3.62	2VA 980 720-001	5.00
2SD 343 130-011	5.00	2SE 007 547-041	5.00	2TM...		2VA 980 720-007	5.00
2SD 343 130-017	5.00	2SE 996 030-011	5.00	2TM 003 057-031	5.100	2VA 997 113-001	5.00
2SD 343 130-071	5.00	2SE 997 005-011	5.00	2TM 003 748-011	5.119	2VA 998 232-251	5.00
2SD 343 130-137	5.00	2SE 997 006-011	5.00	2TM 004 361-021	5.121	2VA 998 232-291	5.00
2SD 343 130-147	5.00	2SE 997 008-001	5.00	2TM 006 717-047	5.117	2VA 998 232-547	5.00
2SD 343 130-157	5.00	2SE 997 088-001	3.04, 3.72, 5.00	2TM 008 645-061	5.126	2VA 998 233-171	5.00
2SD 343 130-167	5.00	2SE 997 111-011	5.00	2TM 008 645-067	5.126	2VA 998 233-171	5.00
2SD 343 130-227	5.00	2SE 997 111-021	5.00	2TM 008 645-071	5.126	2VA 998 233-357	5.00
2SD 343 130-337	5.00	2SE 998 530-061	5.00	2TM 008 645-077	5.126	2VA 998 233-367	5.00
2SD 343 130-377	5.00	2SE 998 530-067	5.00	2TM 008 645-081	5.126	2VA 998 531-031	5.00
2SD 343 130-397	5.00	2SK...		2VB...		2VB...	
2SD 343 130-737	5.00	2SK 003 567-321	5.00	2VB 004 887-011	2.12, 2.15-2.16, 3.39, 3.43-3.44, 3.56, 5.00		
2SD 343 130-747	5.00	2SK 003 567-331	5.00	2V...			
2SD 343 130-797	5.00	2SK 003 567-651	5.00	2V 006 040-051	5.00		
2SD 343 130-807	5.00	2SK 003 567-661	5.00	2V 007 547-171	5.00		
2SD 343 390-011	5.00	2SK 004 460-031	5.00	2V 341 032-111	5.00		
2SD 343 390-401	5.00	2SK 004 460-037	5.00	2V 341 032-117	5.00		
2SD 343 390-407	5.00	2SK 004 460-041	5.00	2V 341 032-121	5.00		
2SD 343 390-417	5.00	2SK 005 883-011	3.76, 3.78-3.79, 3.81, 5.00	2V 341 032-127	5.00		
2SD 343 440-017	5.00			2V 341 032-141	5.00		
2SD 343 440-047	5.00	2SK 005 883-021	3.76, 3.78-3.79, 3.81, 5.00	2V 343 640-011	5.00		
2SD 343 440-057	5.00			2V 343 640-017	5.00		
2SD 343 910-001	5.00	2SK 006 459-041	5.00	2V 343 640-127	5.00		
2SD 343 910-007	5.00	2SK 008 208-051	2.07	2V 343 640-297	5.00		
2SD 343 910-017	5.00	2SK 008 208-061	2.07	2V 998 232-011	5.00		
2SD 343 910-027	5.00	2SK 008 272-801	1.39	2V 998 232-021	5.00		
2SD 344 100-001	5.00	2SK 008 272-831	1.38	2V 998 232-057	5.00		
2SD 344 100-007	5.00	2SK 008 579-091	1.181, 2.35	2V 998 232-101	5.00		
2SD 344 100-101	5.00	2SK 008 579-101	1.181, 2.35	2V 998 232-131	5.00		
2SD 344 169-037	5.00	2SK 008 579-111	1.182, 2.36	2V 998 232-171	5.00		
2SD 344 200-001	5.00	2SK 008 579-121	1.182, 2.36	2V 998 232-201	5.00		
2SD 344 200-007	5.00	2SK 008 579-131	1.182, 2.35	2V 998 232-211	5.00		
2SD 344 200-077	5.00	2SK 008 579-141	1.182, 2.35	2V 998 232-221	5.00		
2SD 344 200-201	5.00	2SK 008 579-151	1.182, 2.36	2V 998 232-231	5.00		
2SD 344 200-207	5.00	2SK 008 579-161	1.182, 2.36	2V 998 232-241	5.00		
2SD 344 200-211	5.00	2SK 008 659-091	1.105, 1.109	2V 998 232-537	5.00		
2SD 344 200-217	5.00	2SK 008 659-101	1.105, 1.109	2VD...			
2SD 344 200-251	5.00	2SK 008 659-111	1.106, 1.109	2VD 003 567-377	5.00		
2SD 344 200-257	5.00	2SK 008 659-121	1.106, 1.109	2VD 005 300-551	3.58, 3.69, 5.00		
2SD 344 200-311	5.00	2SK 008 679-811	1.42	2VD 005 300-581	3.58, 3.69, 5.00		
2SD 344 200-317	5.00	2SK 008 679-831	1.43	2VD 007 323-031	5.00		
2SD 354 040-011	1.157	2SK 008 748-801	1.94, 1.134	2VD 007 323-041	5.00		
2SD 354 040-021	1.157	2SK 009 466-131	1.51	2VD 007 323-131	5.00		
2SD 959 010-401	5.00	2SK 009 466-141	1.51	2VD 007 323-141	5.00		
2SD 959 010-407	5.00	2SK 009 467-111	1.106, 1.110	2VD 007 500-091	3.70, 5.00		
2SD 959 050-401	5.00	2SK 009 467-121	1.106, 1.110	2VD 007 500-111	3.70, 5.00		
2SD 964 169-111	5.00	2SK 009 477-051	1.177	2VD 007 500-201	3.70, 5.00		
2SD 964 169-117	5.00	2SK 009 477-061	1.177	2VD 007 500-221	3.70, 5.00		
2SD 964 169-331	5.00	2SK 010 083-801	1.32	2VD 007 500-411	3.39, 3.42, 3.44-3.46, 5.00		
2SD 964 169-337	5.00	2SK 010 133-801	1.101	2V...			
2SD 964 169-401	5.00	2SK 010 436-091	1.06	2V 007 547-181	5.00		
2SD 964 169-411	5.00	2SK 010 436-101	1.06	2V 008 204-051	3.24, 3.26, 3.35, 3.73, 5.00		
2SD 964 169-421	5.00	2SK 010 437-091	1.06	2V...			
2SD 996 030-021	5.00	2SK 010 437-101	1.06	2V 008 204-071	3.24, 3.26, 3.35, 3.73, 5.00		
2SD 997 005-021	5.00	2SK 343 440-027	5.00	2V 008 204-091	2.12, 3.43, 5.00		
2SD 997 006-021	5.00	2SK 343 440-037	5.00	2V 008 204-111	2.11, 5.00		
2SD 997 006-031	5.00	2SK 343 440-067	5.00	2V 008 204-131	2.30, 5.00		
2SD 997 131-051	5.00	2SK 354 032-011	1.50	2V 008 204-141	3.73, 5.00		
2SD 998 531-057	5.00	2SK 354 032-021	1.50	2V 008 204-151	3.73, 5.00		
2SD 998 531-067	5.00	2SK 354 035-011	1.68	2V 008 204-171	3.08-3.09, 5.00		
2SE...		2SK 354 035-021	1.68	2V 008 204-191	3.10-3.11, 5.00		
2SE 001 306-051	5.00	2SK 964 596-011	1.85, 2.13	2V 008 204-211	5.00		
2SE 001 679-051	5.00	2SK 964 596-021	1.85, 2.13	2V 008 204-231	3.71, 5.00		
2SE 001 680-291	5.00	2SL...		2V 008 204-251	3.04, 3.06-3.07, 3.09-3.10, 3.37, 5.00		
2SE 001 680-301	2.08, 2.14, 5.00	2SL 003 567-311	5.00	2V...			
2SE 001 685-201	3.48, 5.00	2SL 003 567-691	5.00	2V 008 205-011	3.74-3.75, 5.00		
2SE 001 685-221	5.00	2SL 005 883-031	3.76, 3.78-3.79, 3.81, 5.00	2V 008 205-021	3.74-3.75, 5.00		
2SE 001 685-227	5.00			2V 008 205-041	3.77, 3.80-3.81, 5.00		
2SE 001 686-142	5.00	2SL 005 883-041	3.76, 3.78-3.79, 3.81, 5.00	2V 008 205-051	3.77, 3.80-3.81, 5.00		
2SE 001 686-151	5.00			2V 008 789-011	5.00		
2SE 001 688-161	5.00	2SL 007 547-061	5.00	2VP...			
2SE 001 688-161	5.00	2SL 007 547-067	5.00	2VP 003 069-021	1.87		
2SE 001 699-071	3.14, 3.16, 3.48, 3.55, 3.63, 5.00	2ST...		2VP 003 567-111	3.28, 5.00		
		2ST 001 259-321	5.00	2VP 003 567-121	3.28, 5.00		
		2ST 001 673-011	5.00	2VP 003 567-127	5.00		
		2ST 003 014-141	5.102	2VP 004 686-111	1.88		
		2ST 003 018-061	5.00	2VP 004 686-121	1.88		
		2SW...		2VP 004 686-141	1.88		
		2SW 003 014-131	5.102	2VP 004 686-151	1.73, 1.88		
		2SW 003 185-041	5.00	2VP 004 686-181	1.73, 1.88		
		2SW 003 185-047	5.00	2VP 004 887-021	2.12, 2.15-2.16, 3.39, 3.43-3.44, 3.56, 5.00		
		2SW 964 169-081	5.00	2V...			
		2SW 964 169-087	5.00	2V 006 040-111	5.00		
		2SY...		2V 006 040-117	5.00		
		2SY 003 014-121	5.102	2V 006 040-121	5.00		
		2TA...		2V 006 040-127	5.00		
		2TA 344 169-077	5.00	2V 006 040-301	5.00		
		2TA 344 169-087	5.00	2V 006 040-307	5.00		
		2TA 964 169-061	5.00	2V 006 040-351	5.00		
				2V 006 040-357	5.00		



List of Part Numbers

Part number	Page	Part number	Page	Part number	Page	Part number	Page
9BG...		9EL...		9EL...		9EL...	
9BG 859 695-111	6.23	9EL 109 440-002	3.47	9EL 125 910-041	1.169	9EL 139 138-081	1.150
9BG 990 042-061	4.68	9EL 110 013-001	5.176	9EL 126 294-001	5.00	9EL 139 138-091	1.150
9BG 990 178-011	4.66, 4.68	9EL 110 014-001	5.176	9EL 126 339-021	1.23, 1.25	9EL 139 383-031	1.23
9BG 990 297-001	4.67	9EL 110 536-001	5.103	9EL 126 340-021	1.23, 1.25	9EL 139 384-031	1.23
9BG 990 353-001	4.84	9EL 110 536-011	5.103	9EL 127 688-001	1.86	9EL 140 063-021	1.12, 1.25
9BG 993 345-001	4.66, 4.68	9EL 110 540-001	5.102	9EL 127 855-001	3.57, 5.181	9EL 140 064-021	1.12, 1.25
9DE...		9EL 110 542-001	5.103	9EL 128 922-011	3.51, 3.53, 5.213	9EL 140 347-021	1.21
9DE 089 102-011	3.47	9EL 110 736-001	5.177	9EL 129 149-021	1.20, 1.22	9EL 140 348-021	1.21
9DE 116 734-007	3.60, 3.66	9EL 110 910-001	5.176	9EL 129 150-021	1.20, 1.22	9EL 141 135-001	5.117
9DE 118 423-001	3.61, 3.67	9EL 110 918-001	3.52, 5.176	9EL 129 161-011	1.19	9EL 141 135-011	5.117
9DE 118 424-001	3.61, 3.67	9EL 110 918-011	3.52	9EL 129 162-011	1.19	9EL 141 135-021	5.117
9DE 128 657-001	5.108	9EL 110 928-001	5.00	9EL 129 519-001	5.00, 5.00	9EL 141 605-011	1.21
9DE 128 658-001	5.108	9EL 111 647-001	2.08, 2.14, 5.00	9EL 129 614-011	1.87	9EL 141 606-011	1.21
9DE 129 974-021	1.72	9EL 112 741-001	5.00	9EL 129 614-021	1.72-1.73, 1.88	9EL 141 612-001	5.165
9DE 129 975-021	1.72	9EL 112 743-001	5.00	9EL 129 615-011	1.87	9EL 141 701-001	1.146, 1.161
9DE 131 520-017	3.12, 3.14-3.15, 3.19, 4.44	9EL 112 744-001	5.00	9EL 129 615-021	1.72-1.73, 1.88	9EL 141 702-001	1.146, 1.161
9DE 133 697-015	3.07, 3.09	9EL 112 763-001	1.81, 1.103, 2.09, 3.50, 5.164	9EL 129 762-001	1.88	9EL 141 889-031	1.165
9DE 133 698-015	3.07, 3.09	9EL 112 858-011	3.50, 5.164	9EL 129 762-031	1.73, 1.88	9EL 141 889-041	1.165
9DE 145 675-011	3.74	9EL 113 065-001	1.179, 2.29, 2.33	9EL 129 763-001	1.88	9EL 141 890-031	1.165
9DE 145 676-011	3.74	9EL 113 324-001	3.48, 5.00	9EL 129 763-021	1.73, 1.88	9EL 141 890-041	1.165
9DF...		9EL 113 928-001	5.168	9EL 131 420-001	2.12, 2.15-2.16, 3.39, 3.43-3.44, 3.56, 5.00	9EL 141 907-071	1.165
9DF 112 246-001	3.27, 3.30, 3.32, 4.22	9EL 114 400-015	5.121	9EL 131 420-011	2.12, 2.15-2.16, 3.39, 3.43-3.44, 3.56, 5.00	9EL 141 908-071	1.165
9DF 112 247-001	4.22	9EL 114 401-001	5.121	9EL 131 613-031	1.21	9EL 142 459-011	1.164
9DF 117 504-007	3.67	9EL 114 401-031	5.121	9EL 131 614-031	1.21	9EL 142 460-011	1.164
9DR...		9EL 114 401-041	5.121	9EL 131 651-031	1.20, 1.22	9EL 142 723-011	1.185
9DR 060 567-001	4.45	9EL 115 003-001	5.102	9EL 132 215-001	5.160	9EL 142 724-011	1.185
9DR 080 706-015	3.46	9EL 115 003-011	5.102	9EL 132 215-011	3.24, 3.31, 3.35-3.36, 5.160	9EL 142 825-021	1.151
9DR 090 206-001	4.45	9EL 115 003-035	5.102	9EL 132 403-001	5.142, 5.144	9EL 142 825-031	1.151
9DR 135 926-015	1.33, 1.46	9EL 115 003-055	5.103	9EL 132 404-001	5.142, 5.144	9EL 142 826-021	1.151
9DR 136 958-021	1.27	9EL 115 662-001	5.00	9EL 133 713-011	1.163	9EL 142 826-031	1.151
9DS...		9EL 115 662-011	5.00	9EL 133 714-011	1.163	9EL 143 579-021	1.98, 1.138
9DS 121 707-001	4.108, 4.117	9EL 115 662-021	5.00	9EL 133 719-011	1.164	9EL 143 580-021	1.98, 1.138
9DW...		9EL 116 830-035	3.62, 5.182	9EL 133 720-011	1.164	9EL 144 131-001	1.111
9DW 177 229-001	1.44-1.45	9EL 116 380-035	3.52	9EL 134 296-041	3.39, 3.42, 3.44-3.46, 3.58, 3.69-3.70, 5.00, 5.00	9EL 144 132-001	1.111
9DX...		9EL 116 380-045	3.52	9EL 134 296-051	3.39, 3.42, 3.44-3.46, 3.58, 3.69-3.70, 5.00, 5.00	9EL 144 425-001	1.148, 1.178
9DX 119 545-011	3.20, 3.49, 3.52, 3.54, 3.59, 3.64, 5.105	9EL 116 607-005	3.65, 5.186	9EL 134 301-001	3.39, 3.42, 3.44-3.46, 3.58, 3.69-3.70, 5.00, 5.00	9EL 144 425-011	1.148, 1.178
9DX 119 545-051	3.20, 3.49, 3.52, 3.54-3.55, 3.59, 3.65, 5.105, 5.207	9EL 116 771-031	1.142, 1.146, 1.161, 1.168	9EL 134 301-011	5.00, 5.00	9EL 144 426-001	1.148, 1.178
9DX 153 746-011	1.35	9EL 116 844-001	5.00	9EL 134 301-011	5.00, 5.00	9EL 144 426-011	1.148, 1.178
9DX 159 419-001	1.40, 1.47	9EL 116 907-001	3.12, 3.14, 3.16-3.17, 5.174	9EL 134 658-001	5.175	9EL 144 431-001	1.149, 1.178
9DX 859 560-001	6.23-6.24	9EL 117 094-001	5.163	9EL 134 659-001	5.175	9EL 144 431-801	1.149
9DX 859 625-001	6.23-6.24	9EL 117 330-001	5.100	9EL 134 660-001	5.175	9EL 144 443-001	1.118
9DX 859 626-001	6.46	9EL 117 330-011	5.100	9EL 134 739-001	5.00	9EL 144 444-001	1.118
9DX 860 271-001	6.04-6.05	9EL 117 334-001	5.100	9EL 134 740-001	5.00	9EL 145 103-011	3.74
9DX 860 438-001	6.04	9EL 117 334-021	5.100	9EL 134 741-021	5.00	9EL 145 104-011	3.74
9DX 861 872-001	6.40-6.41	9EL 118 445-001	3.53, 3.58	9EL 134 742-021	5.00	9EL 145 660-021	5.168
9DX 861 976-001	6.40-6.41	9EL 118 613-001	5.00	9EL 135 008-021	5.167	9EL 145 833-021	1.11
9DX 862 740-001	6.10-6.11	9EL 118 614-011	5.00	9EL 135 007-001	1.20	9EL 145 834-021	1.11
9DX 862 742-001	6.13	9EL 118 614-021	5.00	9EL 135 008-001	1.20	9EL 145 997-021	1.12
9DX 862 844-001	6.04	9EL 118 633-001	5.00	9EL 135 060-001	5.114	9EL 146 021-001	1.99, 1.135
9DX 862 849-001	6.40-6.41	9EL 118 697-001	5.00	9EL 135 266-001	5.00	9EL 146 021-001	5.179
9EL...		9EL 118 700-001	5.00, 5.00	9EL 135 548-001	3.76, 3.78-3.79, 3.81, 5.00	9EL 146 293-031	1.37
9EL 006 220-851	1.150	9EL 118 701-001	5.00, 5.00	9EL 135 548-001	3.76, 3.78-3.79, 3.81, 5.00	9EL 146 294-031	1.37
9EL 006 220-921	1.151	9EL 118 703-001	5.00	9EL 135 717-001	5.107	9EL 146 371-001	1.181, 2.34
9EL 006 220-931	1.150	9EL 118 705-001	5.00	9EL 136 401-011	1.180, 2.34	9EL 146 372-001	1.181, 2.34
9EL 007 720-821	1.153	9EL 118 705-001	5.00	9EL 136 402-011	1.180, 2.34	9EL 146 373-001	1.181, 2.34
9EL 007 720-831	1.153	9EL 118 707-001	5.00, 5.00	9EL 136 819-011	5.00	9EL 146 491-001	3.13, 5.00
9EL 007 720-851	1.153	9EL 118 707-001	5.00	9EL 136 819-031	5.00	9EL 146 607-001	1.27
9EL 007 720-871	1.154	9EL 118 707-001	5.00	9EL 136 819-041	5.00	9EL 146 838-001	3.39, 3.42, 3.44-3.46, 3.70, 5.159, 5.00, 5.00
9EL 007 727-801	1.13	9EL 118 707-001	5.00	9EL 136 825-001	5.00	9EL 147 073-001	1.63, 1.111, 1.113, 1.115, 1.119, 1.142, 1.149, 1.165, 1.170, 1.174, 1.179, 2.22, 2.32
9EL 007 727-811	1.14	9EL 118 707-001	5.00	9EL 136 825-011	5.00	9EL 147 073-001	1.63, 1.111, 1.114-1.115, 1.119, 1.149, 1.165, 1.170, 1.174, 2.32
9EL 008 679-841	1.43	9EL 118 707-001	5.00	9EL 136 833-001	5.00	9EL 147 096-001	5.00
9EL 008 759-811	1.178	9EL 118 707-001	5.00	9EL 136 833-011	5.00	9EL 147 096-021	5.00
9EL 008 980-801	1.154	9EL 118 707-001	5.00	9EL 136 833-011	5.00	9EL 147 096-031	5.00
9EL 008 980-811	1.154	9EL 118 707-001	5.00	9EL 137 241-001	3.08, 3.61, 3.68, 5.141	9EL 147 097-001	5.00
9EL 043 137-001	5.224	9EL 118 707-001	5.00	9EL 137 307-001	5.00	9EL 147 723-071	1.182-1.183, 1.185
9EL 052 476-001	5.00	9EL 118 707-001	5.00	9EL 137 308-001	5.00	9EL 147 724-071	1.182-1.183, 1.185
9EL 074 484-011	5.174	9EL 118 707-001	5.00	9EL 137 792-011	5.00	9EL 147 747-001	3.15, 3.17, 3.19-3.20, 3.22, 3.48-3.49, 3.64, 5.00
9EL 074 484-031	5.174	9EL 118 707-001	5.00	9EL 137 792-031	5.00	9EL 147 747-001	3.15, 3.17, 3.19-3.20, 3.22, 3.48-3.49, 3.64, 5.00
9EL 084 110-001	5.146	9EL 118 707-001	5.00	9EL 137 819-031	1.53-1.54	9EL 147 747-001	5.00
9EL 085 408-001	5.180	9EL 118 707-001	5.00	9EL 138 463-031	1.25	9EL 147 845-021	1.71
9EL 085 478-001	5.176	9EL 118 707-001	5.00	9EL 138 464-031	1.25	9EL 147 846-021	1.71
9EL 087 769-001	5.185	9EL 118 707-001	5.00	9EL 138 567-031	1.24	9EL 147 910-001	5.119
9EL 088 150-001	3.47, 5.00	9EL 118 707-001	5.00	9EL 138 567-061	1.11, 1.24	9EL 148 141-021	1.13
9EL 088 525-001	5.00	9EL 118 707-001	5.00	9EL 138 568-031	1.24	9EL 148 142-021	1.13
9EL 088 538-001	5.00	9EL 118 707-001	5.00	9EL 138 568-061	1.11, 1.24	9EL 148 179-021	1.153
9EL 089 114-001	5.00	9EL 118 707-001	5.00	9EL 138 601-031	1.185	9EL 148 179-031	1.153
9EL 091 749-011	5.207	9EL 118 707-001	5.00	9EL 138 601-041	1.186	9EL 148 179-101	1.153
9EL 092 435-011	5.00	9EL 118 707-001	5.00	9EL 138 602-031	1.185	9EL 148 179-131	1.153
9EL 101 353-001	5.00	9EL 118 707-001	5.00	9EL 138 602-041	1.186	9EL 148 180-021	1.153
9EL 101 899-001	2.08, 3.50	9EL 118 707-001	5.00	9EL 138 649-031	1.185	9EL 148 180-031	1.153
9EL 101 900-001	2.08, 3.50	9EL 118 707-001	5.00	9EL 138 649-041	1.186	9EL 148 180-101	1.153
9EL 102 240-031	5.00	9EL 118 707-001	5.00	9EL 138 650-031	1.185	9EL 148 180-131	1.153
9EL 104 571-001	5.00	9EL 118 707-001	5.00	9EL 138 650-041	1.186	9EL 148 274-001	5.119
9EL 104 571-041	5.00	9EL 118 707-001	5.00	9EL 139 137-051	1.149	9EL 148 673-021	5.159
9EL 107 368-001	2.08, 2.14, 5.00	9EL 118 707-001	5.00	9EL 139 137-061	1.149	9EL 149 957-121	1.184
9EL 107 443-061	3.47, 5.144	9EL 118					

List of Part Numbers



Part number	Page	Part number	Page	Part number	Page	Part number	Page
9EL...		9EL...		9EL...		9EM...	
9EL 150 988-001	1.68	9EL 354 061-011	1.57	9EL 907 326-001	1.112	9EM 131 614-021	1.21
9EL 151 127-001	3.73	9EL 354 061-021	1.57	9EL 950 315-001	5.158	9EM 137 820-021	1.53-1.54
9EL 151 128-001	3.73	9EL 354 065-011	1.61	9EL 950 315-031	5.158	9ES...	
9EL 151 494-001	5.00	9EL 354 065-021	1.61	9EL 950 315-061	5.158	9ES 012 060-011	4.45
9EL 151 829-011	1.166	9EL 354 066-011	1.61	9EL 962 025-011	1.119	9ES 015 675-001	4.45
9EL 151 830-011	1.166	9EL 354 066-021	1.61	9EL 962 025-031	1.120	9ES 084 374-001	3.47
9EL 151 875-021	1.152	9EL 354 067-011	1.60	9EL 962 026-031	1.120	9ES 091 489-001	3.46
9EL 151 876-021	1.152	9EL 354 067-021	1.60	9EL 962 027-011	1.119	9ES 106 588-001	5.00
9EL 152 051-011	1.98, 1.138	9EL 354 070-011	1.63	9EL 962 028-011	1.119	9ES 113 918-001	3.60, 3.66
9EL 152 052-011	1.98, 1.138	9EL 354 070-021	1.63	9EL 962 541-041	1.171	9ES 113 919-001	3.60, 3.66
9EL 152 884-001	3.74-3.75, 3.77, 3.80-3.81, 5.00	9EL 354 071-011	1.65	9EL 962 542-051	1.171	9ES 118 402-001	3.61, 3.67
9EL 152 889-001	2.30, 3.04, 3.06-3.11, 3.24, 3.26, 3.35, 3.37, 3.71, 3.73, 5.00, 5.00	9EL 354 071-021	1.65	9EL 962 542-071	1.171	9ES 118 403-001	3.61, 3.67
		9EL 354 072-011	2.05	9EL 962 585-041	1.174	9ES 120 723-001	2.07, 2.13, 3.48, 3.50
		9EL 354 072-021	2.05	9EL 962 585-051	1.63	9ES 120 725-001	2.07, 2.13, 3.48, 3.50
		9EL 354 073-011	1.93, 1.133	9EL 962 586-041	1.174	9ES 120 726-001	3.12, 3.14-3.15, 3.19-3.21, 3.27, 3.30, 3.32, 4.44
		9EL 354 073-021	1.93, 1.133	9EL 962 586-051	1.63	9ES 122 221-007	
9EL 152 891-001	2.11-2.12, 3.43, 5.00	9EL 354 074-011	1.126	9EL 962 839-021	1.170, 2.32		
9EL 153 567-101	1.38	9EL 354 074-021	1.126	9EL 962 839-031	1.170, 2.31		
9EL 153 923-021	1.09	9EL 354 075-011	1.125	9EL 962 840-021	1.170, 2.32		
9EL 153 924-021	1.09	9EL 354 075-021	1.125	9EL 962 840-031	1.170, 2.31		
9EL 154 637-001	5.140	9EL 354 076-011	1.127	9EL 963 111-011	1.07	9ES 133 383-005	1.111
9EL 156 099-801	1.111, 1.113, 1.117, 1.120, 1.140, 1.152, 1.166, 1.172, 1.174	9EL 354 076-021	1.127	9EL 963 112-011	1.07	9ES 133 384-005	1.111
		9EL 354 077-011	1.129, 2.25	9EL 963 261-011	1.119	9ES 133 571-005	3.09
		9EL 354 077-021	1.129, 2.25	9EL 963 262-011	1.119	9ES 137 170-015	1.23
9EL 158 254-011	1.09	9EL 354 078-011	1.129	9EL 963 561-801	1.141	9ES 140 721-015	3.07
9EL 158 254-021	1.09	9EL 354 078-021	1.129	9EL 963 561-811	1.141	9ES 140 722-015	3.07
9EL 158 993-001	5.00	9EL 354 079-011	1.129	9EL 963 669-081	1.141	9ES 143 775-011	2.09
9EL 160 467-011	1.93, 1.133	9EL 354 079-021	1.129	9EL 963 670-081	1.141	9ES 143 776-011	2.09
9EL 160 468-011	1.93, 1.133	9EL 354 080-011	1.112	9EL 963 701-011	1.120	9ES 144 433-031	3.74
9EL 161 421-011	1.94, 1.134	9EL 354 080-021	1.112	9EL 963 702-011	1.120	9ES 144 434-031	3.74
9EL 161 422-011	1.94, 1.134	9EL 354 081-011	1.113	9EL 963 982-001	5.120	9ES 145 251-005	1.28
9EL 171 556-031	1.57	9EL 354 082-021	1.113	9EL 963 983-001	5.120	9ES 145 252-005	1.28
9EL 171 556-041	1.57	9EL 354 667-011	1.55	9EL 963 984-001	5.120	9ES 145 599-001	1.11
9EL 171 558-011	1.65	9EL 354 667-021	1.55	9EL 964 005-021	1.172	9ES 145 600-001	1.11
9EL 171 558-021	1.65	9EL 354 668-031	1.96, 1.137	9EL 964 006-021	1.172	9ES 147 313-011	3.08
9EL 171 558-031	1.65	9EL 354 668-041	1.96, 1.137	9EL 964 023-011	1.116	9ES 147 314-011	3.08
9EL 171 558-041	1.65	9EL 354 670-011	1.127	9EL 964 024-011	1.116	9ES 147 315-015	3.10
9EL 171 558-051	1.65	9EL 354 670-021	1.127	9EL 964 055-011	1.116	9ES 147 316-015	3.10
9EL 171 558-061	1.65	9EL 354 672-011	1.130	9EL 964 056-011	1.116	9ES 152 179-001	1.34, 1.36
9EL 171 968-011	2.07	9EL 354 672-021	1.130	9EL 964 116-121	1.172	9ES 152 179-801	1.36
9EL 171 968-021	2.07	9EL 354 678-031	1.61	9EL 964 289-001	5.159	9ES 152 180-001	1.34, 1.36
9EL 171 974-011	1.122	9EL 354 678-041	1.61	9EL 964 290-001	5.159	9ES 170 064-011	3.40-3.41
9EL 171 974-021	1.122	9EL 354 678-071	1.61	9EL 964 291-001	5.159	9ES 170 064-021	3.40-3.41
9EL 171 975-011	1.122, 2.23	9EL 354 678-081	1.61	9EL 964 479-011	1.63	9ES 247 753-001	3.45
9EL 171 975-021	1.122, 2.23	9EL 354 679-011	1.60	9EL 964 480-011	1.63	9ES 247 754-001	3.45
9EL 171 976-011	1.122	9EL 354 679-021	1.60	9EL 964 483-011	1.63	9ES 861 711-001	6.27
9EL 171 976-021	1.122	9EL 852 061-001	6.24	9EL 964 484-011	1.63	9ES 862 011-001	6.26
9EL 171 977-011	1.122, 2.23	9EL 852 061-021	6.24	9EL 964 501-011	1.112, 1.174		
9EL 171 977-021	1.122, 2.23	9EL 852 820-001	6.24	9EL 964 502-011	1.112, 1.174	9EV...	
9EL 172 563-001	6.47	9EL 854 912-001	6.24	9EL 964 526-001	5.00	9EV 113 436-005	3.60-3.61, 3.66-3.67
9EL 172 563-011	6.48-6.49	9EL 855 097-001	6.24	9EL 964 527-001	5.00	9EV 857 067-011	7.06
9EL 172 563-101	6.47	9EL 856 010-001	5.209	9EL 964 527-011	5.00	9EV 859 051-011	7.05
9EL 172 563-111	6.48-6.49	9EL 856 415-001	6.23	9EL 964 529-001	5.00	9EV 861 038-001	7.02-7.04
9EL 172 563-221	6.47	9EL 856 416-001	6.23-6.24	9EL 964 529-011	5.00	9FF...	
9EL 172 563-251	6.33, 6.35	9EL 856 416-011	6.24	9EL 964 530-001	5.00	9FF 042 509-001	8.20
9EL 172 563-321	6.47	9EL 856 417-001	6.23	9EL 964 532-001	5.00	9FF 071 116-001	8.20
9EL 172 563-351	6.33, 6.35	9EL 856 418-001	6.23-6.24	9EL 964 533-001	5.00, 5.00	9FF 078 830-001	8.20
9EL 174 995-001	6.20	9EL 856 418-011	6.24	9EL 964 534-001	5.00	9FF 085 081-001	8.20
9EL 176 574-011	1.66	9EL 856 989-001	6.46	9EL 964 535-001	5.00	9FF 085 642-001	1.86, 3.47
9EL 176 574-021	1.66	9EL 857 576-021	6.46	9EL 964 536-001	5.00	9FF 090 500-001	4.45
9EL 176 575-011	1.66	9EL 857 576-031	6.46	9EL 964 541-021	1.175	9FF 111 606-021	4.44
9EL 176 575-021	1.66	9EL 857 597-001	7.06	9EL 964 542-021	1.175		
9EL 176 576-011	1.67	9EL 857 801-001	6.23	9EL 964 599-001	1.120		
9EL 176 576-021	1.67	9EL 857 803-001	6.23	9EL 964 800-011	5.00		
9EL 176 577-011	1.67	9EL 859 020-001	6.04-6.05	9EL 964 949-001	1.115		
9EL 176 577-021	1.67	9EL 859 020-101	6.04-6.05	9EL 964 950-001	1.115		
9EL 246 151-021	1.124, 1.142	9EL 859 658-001	6.18, 6.25	9EL 982 000-051	1.117	9FF 133 025-007	8.20
9EL 246 152-021	1.124, 1.142	9EL 859 658-011	6.18, 6.25	9EL 982 000-061	1.117	9FF 135 906-021	8.20
9EL 246 175-011	1.125	9EL 860 627-001	6.07-6.08	9EL 982 001-111	1.118	9FF 138 324-001	8.20
9EL 246 176-011	1.125	9EL 860 627-011	6.09	9EL 982 001-121	1.118		
9EL 246 201-011	1.124	9EL 860 628-021	6.07-6.09	9EL 990 034-041	5.104		
9EL 246 202-011	1.124	9EL 861 498-001	6.41, 6.43	9EL 990 034-051	5.104	9FH...	
9EL 270 107-011	1.06, 1.09, 1.13-1.14, 1.18-1.19	9EL 861 498-011	6.41, 6.43	9EL 990 068-001	5.177	9FH 113 447-011	2.07, 3.48, 3.50
		9EL 861 498-021	6.41, 6.43	9EL 990 122-001	5.104	9FT...	
		9EL 861 912-001	6.40-6.42	9EL 990 142-001	5.00	9FT 087 771-001	5.185
9EL 270 197-011	2.30	9EL 861 912-021	6.40-6.41	9EL 990 186-001	4.63-4.64	9FT 088 047-001	5.00, 5.00, 5.00
9EL 270 198-011	2.30	9EL 861 912-041	6.43	9EL 990 632-001	5.00, 5.00	9FT 117 109-007	3.12, 3.14, 3.16-3.17, 5.174
9EL 341 325-311	1.183	9EL 861 912-051	6.43	9EL 990 632-041	5.00		
9EL 341 325-321	1.183	9EL 861 913-001	6.40-6.42	9EL 990 633-011	5.00	9FT 129 176-001	1.86-1.87
9EL 341 326-311	1.184	9EL 861 913-021	6.40-6.41	9EL 990 633-021	5.00	9FT 861 790-001	6.44
9EL 341 326-321	1.184	9EL 861 913-041	6.43	9EL 990 633-031	5.00	9FT 861 790-011	6.44
9EL 343 134-011	5.00, 5.00, 5.00	9EL 861 913-051	6.43	9EL 990 633-041	5.00	9FT 861 790-021	6.39
9EL 343 134-021	5.00	9EL 862 140-001	6.10-6.11	9EL 997 310-001	5.00	9FT 861 790-031	6.39
9EL 343 134-051	5.00, 5.00, 5.00	9EL 862 140-021	6.16-6.17	9EL 997 313-001	5.00	9FT 998 007-011	5.00
9EL 343 134-061	5.00	9EL 862 140-031	6.16-6.17	9EL 997 315-001	5.00		
9EL 343 135-001	5.00, 5.00, 5.00	9EL 862 141-001	6.10-6.12	9EL 997 332-001	5.00	9GD...	
9EL 343 135-011	5.00, 5.00, 5.00, 5.00	9EL 862 141-011	6.12	9EL 997 387-001	5.118	9GD 023 639-001	4.45
9EL 343 135-021	5.00, 5.00, 5.00	9EL 862 141-021	6.10-6.12	9EL 997 388-001	5.118	9GD 024 183-001	4.45
9EL 343 142-001	5.00, 5.00, 5.00	9EL 862 171-001	6.13	9EL 997 451-001	5.00	9GD 052 710-021	3.47
9EL 343 143-001	5.00, 5.00, 5.00	9EL 862 172-001	6.13	9EL 997 452-001	5.00	9GD 082 716-001	5.144
9EL 343 143-011	5.00, 5.00	9EL 862 267-001	6.16, 6.59	9EL 997 453-001	5.00	9GD 087 883-355	3.15, 3.17, 3.19-3.20, 3.22, 3.48-3.49, 3.53, 3.58, 3.64, 5.00
9EL 354 050-011	1.50	9EL 862 267-031	6.09, 6.59	9EL 997 459-001	5.00		
9EL 354 050-02							



List of Part Numbers

Part number	Page	Part number	Page	Part number	Page	Part number	Page
9GD...		9HB...		9XD...			
9GD 341 063-007	5.122, 5.124	9HB 862 827-071	6.44	9XD 861 990-021	6.45		
9GD 343 697-007	5.129-5.130	9HB 862 827-081	6.44	9XD 861 995-801	6.45		
9GD 343 697-107	5.129-5.130	9HB 862 827-091	6.44	9XD 863 533-001	6.29		
9GD 746 185-002	4.36, 5.150-5.152	9HB 862 864-001	6.16-6.17	9XD 863 828-001	6.29		
9GD 854 019-001	6.24	9HD...		9XD 863 828-001	5.219		
9GD 856 466-001	6.18, 6.25	9HD 121 297-001	3.07-3.10	9XD 863 958-001	4.123, 6.22		
9GD 856 562-001	6.23-6.24	9HD 121 297-035	3.20-3.21, 3.27, 3.30, 3.32	9XD 990 284-001	4.59, 4.66, 4.68-4.69, 4.71-4.72, 4.88-4.89, 4.106, 4.110, 4.113-4.114, 4.125		
9GD 856 863-001	6.18, 6.23, 6.25			9XD 990 298-001	4.31-4.32		
9GD 858 013-001	6.23-6.24				5.00, 5.00, 5.00		
9GD 858 086-001	6.23	9HD 140 976-001	4.40	9XR...			
9GD 859 037-001	6.23	9HD 149 253-007	1.110, 1.152, 2.22, 4.26-4.27, 4.108	9XR 854 840-001	6.04, 6.09-6.11, 6.13, 6.23-6.24, 6.59		
9GD 859 037-011	6.13	9HD 155 239-001	3.70, 4.37	9XR 855 975-001	6.05-6.07, 6.38, 6.46, 6.50		
9GD 860 396-001	6.22	9HD 990 101-001	4.46, 4.109-4.110	9XS...			
9GD 860 772-001	6.22	9KS...		9XS 027 639-001	4.121-4.122		
9GD 862 080-001	6.45	9KS 075 139-001	4.45	9XS 118 079-005	4.42		
9GD 862 081-001	6.45	9KS 075 307-001	4.45	9XS 124 218-027	4.31-4.32		
9GD 862 085-001	6.45	9MA...		9XS 124 218-037	4.29		
9GD 862 164-001	6.10, 6.12, 6.16, 6.22	9MA 864 153-801	6.32	9XS 854 769-001	7.06		
9GD 862 178-001	6.13	9MK...		9XS 855 646-001	7.06		
9GD 862 679-001	6.16-6.17	9MK 854 066-001	6.23-6.24, 6.46	9XS 857 585-001	7.06		
9GD 862 734-001	6.13	9MK 860 255-001	6.52, 6.58	9XS 857 588-001	7.06		
9GD 863 033-001	6.22	9MK 862 862-001	6.16-6.17	9XS 861 127-051	7.03-7.04		
9GD 863 122-001	6.39, 6.53	9MK 862 863-001	6.16-6.17	9XS 861 736-001	7.04		
9GD 864 285-001	6.39, 6.53	9MM...		9XS 862 004-001	7.02-7.04		
9GD 864 286-001	6.39, 6.53	9MM 010 657-001	6.54	9XX...			
9GD 864 286-011	6.39, 6.53	9MM 859 358-801	6.52, 6.58	9XX 340 220-011	5.123		
9GD 864 286-021	6.39, 6.53	9MM 862 358-801	6.52, 6.58				
9GD 963 281-001	5.116	9MM 863 164-051	6.54				
9GD 980 696-001	5.184, 5.00	9MM 863 165-001	6.50				
9GH...		9MN...					
9GH 096 532-001	4.123, 6.21-6.22	9MN 854 290-001	6.12, 6.24				
9GH 116 966-011	1.80-1.81, 1.102-1.103, 1.141, 1.145, 1.173, 1.179, 2.29, 2.32, 3.25, 3.38, 3.54	9MN 858 114-001	6.04-6.05				
		9MN 858 114-011	6.04-6.05				
		9MN 858 616-001	6.23				
9GH 126 647-011	4.39, 4.41	9MN 858 616-011	6.23				
9GH 136 698-007	5.107	9MN 860 677-001	6.07-6.09				
9GH 145 943-001	3.70, 4.31, 4.37	9MN 860 677-011	6.07-6.09				
9GH 145 943-012	4.30	9MN 860 677-021	6.07-6.09, 6.40-6.41				
9GH 147 009-007	4.26-4.27, 4.108	9MN 862 741-001	6.04, 6.10-6.11, 6.13				
9GH 152 654-007	4.31	9MN 863 026-001	6.05-6.07				
9GH 152 654-012	4.30	9NM...					
9GH 156 191-001	3.45	9NM 863 332-001	4.123, 6.06, 6.11, 6.15, 6.17, 6.22				
9GH 158 051-007	4.29	9NS...					
9GH 990 316-031	4.64	9NS 114 014-106	4.42				
9GH 990 334-011	4.59, 4.113-4.114	9NS 119 463-005	4.42				
9GH 993 984-001	4.50-4.52, 4.54-4.56, 4.79-4.81, 4.84-4.89, 4.96, 4.100, 4.106, 5.167, 4.64-4.65	9NS 124 485-001	4.42				
		9NS 152 922-007	4.31-4.32				
9GH 993 988-007	4.64-4.65	9SG...					
9GP...		9SG 703 965-007	6.55, 6.57				
9GP 003 995-801	3.25, 3.28-3.29, 3.31, 3.34, 3.38, 5.00, 5.00, 5.00, 5.00	9SG 855 454-011	7.02-7.04, 7.06				
	6.04	9SG 855 498-001	7.02-7.04, 7.06				
9GP 859 115-001	6.04	9SG 998 005-002	4.126				
9GS...		9ST...					
9GS 146 999-727	4.38	9ST 855 447-001	7.06				
9GT...		9ST 861 074-001	7.02-7.04				
9GT 005 166-001	3.18, 5.157, 5.159	9ST 863 241-001	7.03				
9GT 067 751-001	4.44	9SX...					
9GT 074 132-001	3.14, 3.16, 3.18, 3.28, 3.48, 3.55, 3.63, 3.70, 5.00, 5.00, 5.00	9SX 008 902-001	6.51				
		9SX 008 902-021	6.54, 6.56				
9GT 134 655-007	5.113	9SX 178 258-001	6.32				
9GT 137 236-007	5.00, 5.00	9SX 863 114-001	6.51, 6.55, 6.57				
9GT 141 941-001	2.12, 2.15-2.16, 3.39, 3.43-3.44, 3.56, 5.00	9XB...					
		9XB 136 202-005	5.213				
9GT 143 133-007	5.113	9XB 152 977-001	4.30-4.31				
9GT 146 757-007	5.170-5.171	9XB 161 749-007	5.00				
9GT 341 438-007	5.00, 5.00, 5.00, 5.00, 5.00, 5.00	9XB 167 882-001	6.56				
		9XD...					
9GT 343 367-002	5.131-5.132	9XD 127 264-007	5.101				
9GT 963 129-001	5.116	9XD 130 261-001	4.49, 4.74-4.75, 4.80, 4.117-4.118, 4.125				
9GT 990 338-001	4.84						
9HB...		9XD 132 749-005	5.00				
9HB 006 948-031	1.164	9XD 160 867-007	5.134				
9HB 006 948-041	1.164	9XD 161 119-007	5.00				
9HB 126 601-001	3.25, 3.29, 3.31, 3.34, 3.38, 5.00	9XD 161 119-017	5.00				
		9XD 176 641-801	6.53				
9HB 152 021-007	5.171	9XD 247 755-001	3.45				
9HB 161 122-007	5.00	9XD 247 756-001	3.45				
9HB 161 122-012	5.00	9XD 254 226-007	4.32-4.34				
9HB 163 085-001	5.00	9XD 254 227-007	4.32-4.34				
9HB 163 085-012	5.00	9XD 344 118-101	5.203				
9HB 164 168-002	5.00	9XD 344 192-061	5.195-5.200				
9HB 183 460-001	1.157	9XD 344 192-071	5.195-5.200				
9HB 183 460-101	1.60	9XD 857 445-801	6.45				
9HB 862 827-011	6.44	9XD 857 579-001	7.06				
9HB 862 827-021	6.44	9XD 857 744-001	7.02-7.04, 7.06				
9HB 862 827-031	6.44	9XD 861 990-001	6.45				
9HB 862 827-041	6.44	9XD 861 990-011	6.45				
9HB 862 827-051	6.44						
9HB 862 827-061	6.44						



Manufacturer's no. / Hella no.

Cross-Reference

BMW	Hella	BMW	Hella	BMW	Hella	Bosch	Hella
3 381 900	8JA 001 909-001	63 17 4 257 705	9GD 860 396-001	7 740 038	2AA 003 257-001	1 987 302 045	8GJ 002 525-361
3 416 773	1NO 010 501-001	63 17 6 900 221	1NA 354 693-011	7 767 895	1FO 160 197-001	1 987 302 071	8GH 007 157-121
3 434 957	9EL 854 912-001	63 17 6 900 222	1NA 354 693-021	7 894 017	1NO 354 683-011	1 987 302 075	8GH 007 157-181
3 436 336	8GA 002 073-121	63 17 6 905 501	1NB 354 694-011	7 894 018	1NO 354 683-021	1 987 302 081	8GH 008 356-121
3 864 672	2DA 003 014-031	63 17 6 905 502	1NB 354 694-021	7 897 187	1NO 354 696-011	1 987 302 082	8GH 008 357-001
3 864 672	2DA 003 014-037	63 17 6 910 791	1NO 010 345-011	7 897 188	1NO 354 696-021	1 987 302 084	8GH 008 358-121
4 002 911	8RA 003 326-001	63 17 6 910 792	1NO 010 345-021	8 352 023	1NA 007 039-011	1 987 302 152	8GH 005 635-121
4 002 911	8RA 003 326-002	63 17 6 911 007	1NA 354 695-011	8 352 024	1NA 007 039-021	1 987 302 153	8GH 005 636-121
0 414 700	9EL 008 679-841	63 17 6 920 703	1NO 354 685-011	8 353 545	1LJ 007 143-051	1 987 302 201	8GA 002 073-121
4 184 716	9FF 071 116-001	63 17 6 920 704	1NO 354 685-021	8 353 546	1LJ 007 143-061	1 987 302 202	8GD 002 078-121
4 184 717	9FF 078 830-001	63 17 6 937 465	1NA 354 698-011	8 357 385	1NB 006 270-051	1 987 302 203	8GA 002 071-131
4 190 562	1KB 003 177-061	63 17 6 937 466	1NA 354 698-021	8 357 386	1NB 006 270-061	1 987 302 204	8GA 002 071-121
4 193 968	9EL 852 820-001	63 17 6 943 415	1NO 354 686-011	8 357 389	1NB 006 270-051	1 987 302 206	8GP 003 594-121
4 257 704	2RL 007 337-101	63 17 6 943 416	1NO 354 686-021	8 357 390	1NB 006 270-061	1 987 302 207	8GP 002 067-121
4 257 705	9GD 860 396-001	63 17 6 948 373	1NA 010 502-011	8 359 493	9AG 144 019-005	1 987 302 208	8GP 002 095-121
4 830 861.9 00	2BA 008 221-001	63 17 6 948 374	1NA 010 502-021	8 360 575	1NA 009 026-011	1 987 302 209	8GD 002 084-131
4 830 861.9 00	2BA 008 221-007	63 17 7 894 017	1NO 354 683-011	8 360 576	1NA 009 026-021	1 987 302 210	8GM 002 091-131
61 13 1 243 841	9GH 096 532-001	63 17 7 894 018	1NO 354 683-021	8 361 007	9GS 007 949-101	1 987 302 211	8GM 002 092-121
61 31 1 390 388	9SG 703 965-007	63 17 7 897 187	1NO 354 696-011	8 361 099	9ES 145 251-005	1 987 302 212	8GP 002 068-121
61 33 1 371 557	3AF 003 399-051	63 17 7 897 188	1NO 354 696-021	8 361 100	9ES 145 252-005	1 987 302 213	8GA 006 841-121
62 10 7 740 038	2AA 003 257-001	63 17 8 352 023	1NA 007 039-011	8 361 103	9GD 142 757-031	1 987 302 214	8GA 002 072-121
62 14 2 230 248	2AA 003 257-031	63 17 8 352 024	1NA 007 039-021	8 361 939	1LL 007 250-011	1 987 302 215	8GD 004 772-121
62 14 2 230 249	2AA 003 257-021	63 17 8 357 385	1NB 006 270-051	8 361 940	1LL 007 250-021	1 987 302 217	8GP 003 594-141
62 14 2 230 250	2AA 003 257-011	63 17 8 357 386	1NB 006 270-061	8 361 951	1ND 007 646-011	1 987 302 220	8GA 007 997-041
62 14 8 680 130	9FF 085 642-001	63 17 8 357 389	1NB 006 270-051	8 361 952	1ND 007 646-021	1 987 302 221	8GA 007 997-081
63 11 7 161 673	1LL 354 687-031	63 17 8 357 390	1NB 006 270-061	8 363 557	9EL 146 293-031	1 987 302 224	8GP 002 066-121
63 11 7 161 674	1LL 354 687-041	63 17 8 360 575	1NA 009 026-011	8 363 558	9EL 146 294-031	1 987 302 226	8GM 002 094-121
63 11 7 162 081	1ZS 354 688-031	63 17 8 360 576	1NA 009 026-021	8 374 235	2BA 003 236-321	1 987 302 229	8GM 002 091-121
63 11 7 162 082	1ZS 354 688-041	63 17 8 361 951	1ND 007 646-011	8 374 235-02	2BA 003 236-321	1 987 302 230	8GM 002 091-181
63 11 7 228 425	1ZS 354 690-031	63 17 8 361 952	1ND 007 646-021	8 381 977	1NA 009 026-011	1 987 302 231	8GH 002 473-151
63 11 7 228 426	1ZS 354 690-041	63 17 8 381 977	1NA 009 026-011	8 381 978	1NA 009 026-021	1 987 302 232	8GH 007 643-121
63 11 7 228 431	1LL 354 689-031	63 17 8 381 978	1NA 009 026-021	8 680 130	9FF 085 642-001	1 987 302 232	8GH 007 643-171
63 11 7 228 432	1LL 354 689-041	63 21 0 414 700	9EL 008 679-841	8 680 130	8GA 002 071-121	1 987 302 238	8GM 002 091-141
63 11 7 240 265	1ZS 354 692-031	63 21 1 384 009	2VA 005 553-111	9 400 198	2AB 004 532-021	1 987 302 240	8GP 938 026-001
63 11 7 240 266	1ZS 354 692-041	63 21 1 384 010	2VA 005 553-121	9 822 034	9FF 085 642-001	1 987 302 241	8GP 003 594-541
63 12 1 356 409	1K3 114 155-001	63 21 6 900 209	2VP 008 272-231	9 978 227	8GA 002 071-121	1 987 302 244	8GA 007 997-001
63 12 1 356 415	1M3 114 178-001	63 21 6 900 210	2VP 008 272-241	9 978 311	8GM 002 091-121	1 987 302 245	8GH 002 473-132
63 12 1 359 777	9NS 114 014-106	63 21 6 910 767	2VP 008 679-111	9 978 372	8GP 003 594-141	1 987 302 411	8GH 002 089-251
63 12 1 369 842	1K3 126 046-001	63 21 6 910 768	2VP 008 679-121	9 978 373	8GP 003 594-121	1 987 302 411	8GH 002 089-253
63 12 1 370 904	1K3 126 680-001	63 21 7 177 697	2TZ 009 427-111	9 978 391	8GH 002 090-133	1 987 302 421	8GD 002 088-251
63 12 1 373 511	1K3 126 046-001	63 21 7 177 698	2TZ 009 427-121	9 978 396	8GD 002 088-131	1 987 302 422	8GH 002 857-241
63 12 1 373 512	1K3 126 680-001	63 21 8 363 557	9EL 146 293-031			1 987 302 431	8GH 002 090-251
63 12 1 373 529	9AG 126 547-005	63 21 8 363 558	9EL 146 294-031			1 987 302 431	8GH 002 090-253
63 12 1 378 325	9AH 131 741-011	63 23 6 952 586	2XD 008 997-001	1 300 312 025	9GT 067 751-001	1 987 302 441	8GJ 002 525-281
63 12 1 378 326	9AH 131 740-011	63 23 8 374 235	2BA 003 236-321	1 300 508 024	9GH 116 966-011	1 987 302 442	8GJ 002 525-251
63 12 1 378 337	1K3 132 253-011	63 26 1 354 665	2KA 004 331-031	1 300 508 034	9HD 121 297-001	1 987 302 471	8GH 007 157-241
63 12 1 378 338	1K3 132 266-011	63 31 1 367 353	2JA 003 388-001	1 300 508 034	9HD 121 297-035	1 987 302 501	8GA 002 073-241
63 12 1 382 495	8GH 005 635-121	63 31 1 376 329	2JA 003 388-001	1 300 630 034	9FF 085 642-001	1 987 302 503	8GA 002 073-251
63 12 1 385 461	8GH 005 636-121	63 31 2 137 730	2JA 004 192-001	1 300 636 140	9FF 126 444-001	1 987 302 504	8GA 002 095-241
63 12 1 385 462	1K3 134 855-011	63 31 2 137 730	2JA 004 192-001	1 304 485 004	8JA 001 909-001	1 987 302 505	8GA 002 071-251
63 12 1 386 403	1K3 134 856-011	6 398 001	8GM 002 091-131	1 304 485 900	8JA 001 909-001	1 987 302 507	8GM 002 092-241
63 12 1 386 404	1K3 134 855-011	6 398 020	2BA 003 014-011	1 305 219 004	9HD 121 297-001	1 987 302 508	8GP 002 068-241
63 12 1 386 408	1K3 134 856-011	6 900 209	2BM 002 847-011	1 305 230 904	9EL 129 161-011	1 987 302 510	8GA 002 071-241
63 12 1 386 408	1K3 134 856-011	6 900 210	2VP 008 272-231	1 305 230 906	9EL 129 162-011	1 987 302 511	8GA 002 071-261
63 12 1 386 715	9BG 135 941-011	6 900 221	2VP 008 272-241	1 305 230 906	9EL 135 007-001	1 987 302 512	8GA 002 067-241
63 12 1 386 716	9BG 135 942-011	6 900 222	1NA 354 693-011	1 305 230 916	9EL 135 008-001	1 987 302 514	8GA 007 997-071
63 12 1 386 805	1DL 005 930-371	6 900 222	1NA 354 693-021	1 305 230 916	9EL 141 605-011	1 987 302 517	8GP 003 594-241
63 12 1 386 806	1DL 005 930-381	6 900 797	9ES 862 011-001	1 305 230 917	9EL 141 606-011	1 987 302 518	8GP 003 594-251
63 12 1 390 270	9DR 136 958-021	6 902 519	1LL 008 053-591	1 305 232 921	9EL 150 987-001	1 987 302 519	8GP 002 066-241
63 12 1 390 275	9BG 135 927-011	6 902 520	1L5 008 053-601	1 305 232 922	9EL 150 988-001	1 987 302 521	8GM 002 091-251
63 12 1 390 276	9BG 135 928-011	6 902 765	2BA 008 404-011	1 305 232 923	9EL 150 867-001	1 987 302 522	8GM 002 091-241
63 12 1 390 301	9DR 135 926-015	6 902 766	2BA 008 404-021	1 305 232 924	9EL 150 868-001	1 987 302 523	8GA 002 072-241
63 12 2 776 500	2BA 001 236-001	6 902 769	2BA 008 404-031	1 305 233 051	2BA 003 110-011	1 987 302 524	8GD 002 078-241
63 12 2 913 900	9AG 084 320-005	6 902 770	2BA 008 404-041	1 305 233 106	2BA 003 110-021	1 987 302 525	8GP 002 067-261
63 12 6 902 519	1LL 008 053-591	6 904 048	9DX 153 746-011	1 305 233 106	9EL 129 615-011	1 987 302 528	8GM 002 094-241
63 12 6 902 520	1LL 008 053-601	6 905 501	1NB 354 694-011	1 305 233 917	9EL 120 652-001	1 987 302 529	8GM 002 091-261
63 12 6 904 048	9DX 153 746-011	6 905 502	1NB 354 694-021	1 305 233 928	9EL 129 615-011	1 987 302 602	8GP 002 068-131
63 12 6 907 489	5DD 008 319-501	6 907 489	5DD 008 319-501	1 305 233 929	9EL 129 614-011	1 987 302 603	8GP 002 067-061
63 12 6 916 097	9DX 159 419-001	6 910 767	2VP 008 679-111	1 305 311 050	9DR 060 567-001	1 987 305 007	9AH 144 231-041
63 12 6 917 125	1LL 158 085-011	6 910 768	2VP 008 679-121	1 305 313 935	1G8 132 233-011	1 987 305 007 000 59	9AH 144 231-041
63 12 6 917 126	1LL 158 086-011	6 910 791	1NO 010 345-011	1 305 320 818	9DF 112 246-001	1 987 305 008	9AH 144 232-041
63 12 6 937 223	5DV 009 000-001	6 910 792	1NO 010 345-021	1 305 320 818	9DF 112 247-001	1 987 305 008 000 59	9AH 144 232-041
63 12 7 165 453	1LL 158 085-011	6 911 007	1NA 354 695-001	1 305 331 903	1K3 126 046-001	1 987 305 011	9EL 145 833-021
63 12 7 167 895	1FO 160 197-001	6 916 097	9DX 159 419-001	1 305 331 904	1K3 126 680-001	1 987 305 012	9EL 145 833-021
63 12 8 353 545	1LJ 007 143-051	6 916 097	2DA 003 236-331	1 305 331 909	1K3 134 855-011	1 987 305 011 000 59	9EL 145 834-021
63 12 8 353 546	1LJ 007 143-061	6 917 125	1LL 158 085-011	1 305 331 910	1K3 134 856-011	1 987 305 012 000 59	9EL 145 834-021
63 12 8 359 493	9AG 144 019-005	6 917 126	1LL 158 086-011	1 305 363 958	9DE 129 975-021	1 987 305 013	9ES 145 599-001
63 12 8 361 007	8GS 007 949-101	6 920 703	1NO 354 685-011	1 305 363 959	9DE 129 974-021	1 987 305 013 000 59	9ES 145 599-001
63 12 8 361 009	9ES 145 251-005	6 920 704	1NO 354 685-021	1 305 365 915	9DE 131 520-017	1 987 305 014	9ES 145 600-001
63 12 8 361 100	9ES 145 252-005	6 920 703	5DV 009 000-001	1 305 501 046	9AG 126 547-005	1 987 305 014 000 59	9ES 145 600-001
63 12 8 361 103	9GD 142 757-031	6					

Manufacturer's no. / Hella no.

Cross-Reference



Bosch	Hella	Bosch	Hella	Case IH	Hella	Case IH	Hella
0 301 608 611	1L8 003 060-691	7 782 374 006	2RL 008 062-111	3 224287 R1	9EL 115 662-011	9 803936 9	2TJ 001 633-211
0 301 608 613	1L8 004 190-111	7 782 374 203	2RL 008 062-011	3 229393 R1	2PF 003 014-071	9 804137 1	2SK 003 014-151
0 301 709 001	1KB 003 177-061	7 782 430 030	1G9 001 523-021	3 229394 R1	2SA 003 014-051	9 804245 9	2BA 001 386-281
0 301 709 600	1LB 003 177-081	8 780 556 000	9GH 096 532-001	3 369718 R91	1G4 003 470-051	9 804591 0	2RL 007 551-001
0 305 063 003	1NO 009 594-011	8 785 510 065	9EL 856 418-011	3 512768 M91	1GA 005 060-337	9 804617 1	1GB 006 213-101
0 305 063 004	1NO 009 594-021	8 785 510 071	9EL 852 820-001	4 022274 6	8RA 002 020-001	9 804617 1	1GB 006 213-107
0 305 064 901	1ND 005 700-841	8 785 510 073	9EL 855 097-001	4 022274 6	8RA 002 020-002	9 804669 8	9EL 136 825-011
0 305 603 001	1N4 005 750-801	8 785 510 098	9EL 854 912-001	47056352	8RA 002 020-003	9 804669 9	9EL 136 825-001
0 305 603 901	1N4 005 750-801	8 787 022 013	8HG 002 365-001	47056353	1GA 996 083-011	9 804750 6	9EL 860 627-001
0 306 407 001	1FD 005 700-051	8 787 022 016	8HG 006 294-051	47056354	1GA 996 083-011	9 961 9A1	9DX 859 626-001
0 306 480 001	1G5 003 241-021	8 787 220 627	8HG 006 294-011	47056355	1GA 996 083-011	B 503 078	2SE 002 582-071
0 306 606 901	1F4 005 750-811	8 787 510 023	9MN 860 677-001	47056356	1GA 996 083-021	E46821	1GA 998 522-011
0 307 106 001	2ZR 002 589-011	8 787 510 023	8GH 002 089-251	47056357	1GA 996 083-021	G841783	1GA 998 522-011
0 307 851 327	6NM 004 375-311	8 787 540 003	8GH 002 089-253	47056358	1GA 996 083-011	K 303 720	2JA 002 931-031
0 307 851 347	6NM 007 282-211	8 797 022 002	8GM 002 092-121	47056359	1GA 996 083-011	K 965 604	2SD 001 693-011
0 307 852 309	6NM 004 375-311	8 797 337 026	2JA 003 231-001	4 705 724 7	1GA 996 083-021	Caterpillar	
0 310 152 006	2AA 003 257-041	0 986 310 093	2AA 001 200-131	4 705 724 8	1GA 996 083-021	120-6776	Hella
0 310 152 006	2AA 003 257-042	0 986 310 093	2AA 003 257-041	0 605006 47	8GA 002 071-251	120-6776	1G4 003 470-051
0 310 153 002	2AA 001 204-001	0 986 310 526	1F8 007 560-311	0 605020 70	1GA 005 060-041	120-6776	1GB 006 213-101
0 310 153 004	2AA 001 204-031	RKLE 200 D	2RL 008 062-001	0 605020 70	1GA 998 522-011	1244081	1GA 006 991-031
0 310 153 010	2AA 001 204-011	RKLE 200 D	2RL 008 062-011	0 605056 92	1GA 006 991-091	00137330	1GA 007 506-002
0 311 109 001	2ST 001 673-011	RKLE 200 D	2RL 008 062-101	0 605058 52	2BA 001 277-021	00137330	1GA 007 506-007
0 311 109 002	2SB 001 673-002	RKLE 200 D	2RL 008 062-111	0 605058 60	2BA 001 277-011	00137330	1GA 007 506-001
0 311 113 007	2SE 001 680-291	Bremi		0 605 063 30	8GM 002 091-251	00137350	1GA 007 506-002
0 311 113 007	2SE 002 582-071	10402A	Hella	0 605070 67	1GB 006 213-101	00137350	1GA 007 506-007
0 311 113 008	2SD 001 680-281	10813	8KW 701 235-033	0 605070 67	1GB 006 213-107	199-3137	1GA 007 506-007
0 311 113 009	2SD 003 184-037	10908B	8JA 004 667-001	0 605070 67	1GB 006 213-111	1993138	1GL 008 090-211
0 311 118 001	2SE 001 699-071	10908GE	2AA 001 200-001	0 605070 67	1GB 006 213-117	1993138	1GL 008 090-217
0 311 118 002	2SD 001 699-061	10908GR	2AA 001 200-021	0 605098 64	2SE 002 578-701	199-3139	1GA 007 506-491
0 311 150 005	2SB 001 240-311	10908R	2AA 001 200-011	0 605098 64	2SE 002 578-707	02449820	8GA 002 071-131
0 311 313 001	2BA 001 234-251	10920SBL	2AA 003 257-011	0 605191 34	2PF 001 259-631	3103207	1GO 996 176-031
0 311 313 002	2BA 001 234-261	10920SGR	2AA 003 257-021	0 605191 42	2SA 001 259-751	03180600	8RA 002 014-081
0 311 316 004	2BA 003 734-001	10920SR	2AA 003 257-001	0 605193 43	2SA 001 259-757	03180610	8RA 002 014-101
0 311 328 001	2BA 008 404-011	11155A	8JA 001 909-011	0 605193 76	1DL 007 872-037	03230800	8GA 002 073-121
0 311 328 002	2BA 008 404-021	11575/15SB	8JS 711 687-821	0 605245 33	2BA 004 119-017	03240030	8GD 002 078-121
0 311 328 003	2BA 008 404-031	Case IH		0 605257 76	1DL 007 872-047	5W-2681	1G4 003 470-051
0 311 328 004	2BA 008 404-041	1 074840 C 1	Hella	0 605257 84	2JA 001 346-011	826850	1GA 006 875-001
0 311 424 004	2SD 001 686-101	1 074840 A 1	8RA 002 016-111	0 605315 16	2BM 002 847-021	L04002	1GL 008 090-211
0 311 424 005	2SE 001 686-142	1 089208 R91	8RA 002 016-111	0 605315 16	1GA 007 506-001	L04026	1GL 008 090-217
0 311 424 006	2SD 001 686-101	0 111950 1	1G4 003 470-031	0 605315 16	1GA 007 506-002	L04030	1GA 006 991-051
0 311 424 007	2SE 001 685-201	1 328046 C1	1G4 004 480-001	0 605316 19	1GA 007 506-007	LO4026	1GL 008 090-211
0 311 424 007	2SE 001 685-221	1 328113 C1	9EL 115 662-021	0 605329 10	2BE 003 014-251	LO4026	1GL 008 090-217
0 311 424 007	2SE 001 685-227	1 333292 C2	1VB 005 444-037	0 605338 72	2BE 003 014-257	LO4030	1GA 006 991-051
0 311 424 008	2SD 001 685-211	1 333 295 C1	1LB 003 177-081	679 850 R91	2JA 004 192-001	5W-2681	1G4 003 470-051
0 311 424 008	2SD 001 685-218	1 346 724 001	1GA 996 020-001	679 850 R91	2AA 001 200-011	826850	1GA 006 875-001
0 311 424 008	2SD 001 685-231	1 34 672 4001	1GA 996 020-001	679 850 R91	2AA 001 200-012	L04002	1GL 008 090-211
0 311 424 009	2SD 001 685-232	1-34-701-505	2BE 003 014-251	679 873 R91	2AA 001 200-021	L04026	1GL 008 090-217
0 311 424 009	2SE 001 686-142	1-34-701-505	2BE 003 014-257	0 700255 4	2AA 001 200-023	L04030	1GA 006 991-051
0 311 424 010	2SD 001 686-101	1 347760 10	9EL 118 614-011	0 700255 5	8GP 002 066-121	LO4026	1GL 008 090-211
0 311 425 001	2SE 003 167-031	1-40-172-007	1GB 996 080-021	0 700255 7	8GA 002 071-121	LO4030	1GL 008 090-217
0 311 425 002	2SD 003 167-021	1 401 720 11	1GB 996 080-021	0 700501 0	2BA 002 652-121	LO4030	1GL 008 090-211
0 311 425 003	2SD 003 167-011	1 401 720 12	1GA 996 083-011	0 700502 7	2BA 002 652-111	LO4030	1GL 008 090-217
0 312 201 002	2DA 003 734-011	1-40-172-0121	1GA 996 083-011	0 700502 7	2BA 002 652-117	LO4030	1GL 008 090-211
0 313 050 005	2SA 003 734-121	1 40 172 0141	1GA 996 083-021	7 024794	2GA 002 073-121	LO4030	1GA 006 991-051
0 313 104 001	2NE 002 589-001	1 40 172 0151	1GA 996 083-021	00 70249 87	8GA 002 073-241	6350.S7	2SK 009 466-131
0 313 110 002	2NE 003 734-091	1 401 720 16	1GA 996 083-011	0 703499 7	8GH 002 090-133	6350.T6	2VP 354 030-011
0 314 107 002	2ZR 003 734-041	1-40-172-0161	1GA 996 083-011	0 703499 7	8GH 002 090-133	6350.T6	2SK 354 032-011
0 315 104 027	2PF 003 734-031	1 401 790 021	1GA 998 522-011	0 706768 3	8GA 002 071-131	6350.T8	2NE 354 050-011
0 318 214 203	2BA 006 749-071	1 401 790 021	1GA 998 522-011	0 706770 6	2SD 002 776-241	6350.V1	2XX 354 033-011
0 318 214 204	2BA 006 749-081	1 401 790 03	1GA 998 522-011	0 706771 4	2SD 002 776-247	6350.V1	2XX 354 052-011
0 318 348 103	9EL 151 875-021	1 401 790 031	1GA 998 522-011	0 706771 4	2SD 002 776-237	6350.V1	2VP 354 030-031
0 318 348 104	9EL 151 876-021	1 405 720 01	1GA 996 083-011	0 706771 4	2KA 003 389-061	6351.AC	2SK 009 466-141
0 318 408 013	1NA 009 026-011	1 405 720 011	1GA 996 083-011	0 706774 7	2KA 003 389-062	6351.S7	2VP 354 030-021
0 318 408 014	1NA 009 026-021	1 405 720 02	1GA 007 506-681	0 706774 7	2KA 003 389-068	6351.T7	2NE 354 053-021
0 320 223 002	3AF 003 399-041	1 40 572 0021	1GA 007 506-681	0 706917 0	8GA 002 071-251	6351.T8	9EL 354 050-021
0 320 223 003	3AF 003 399-051	1 407722 12	1GA 998 525-001	0 707370 4	2XS 950 071-031	6351.T9	2XX 354 033-021
0 320 223 008	3AF 003 399-041	1 89124A 2	2PS 003 748-121	0 707374 5	8HG 006 294-051	6351.V0	2NE 354 051-021
0 320 223 009	3AF 003 399-051	1 89124A 2	2PS 003 748-127	0 707383 3	2VA 006 040-071	6351.V0	2VP 354 030-041
0 320 226 003	3AF 003 399-061	1 987 491 C2	1GA 998 522-011	0 707383 3	2VA 006 040-077	9681873680	1GL 009 767-041
0 332 019 150	4RA 933 791-061	0 211950 2	2VP 006 040-111	0 707384 1	2VP 006 040-121	9681874080	1GL 009 767-031
0 341 201 006	6ZE 001 759-051	0 211950 2	2VP 006 040-117	0 707384 1	2VP 006 040-127	KN.210.03	2NE 003 030-151
0 341 500 801	6EG 001 567-041	0 211950 3	2VP 006 040-121	0 707384 1	2VP 006 040-127	KN.210.03	2ZR 003 030-171
0 352 070 009	8JB 001 943-001	3 051599 R91	2VP 006 040-127	0 707481 8	2RL 006 846-001	KN.215.04	2DA 007 428-001
0 352 070 012	8JB 001 943-001	3 051600 R91	2SB 001 259-261	0 707491 4	8JA 003 526-001	KN.215.04	2DA 007 428-001
0 352 170 003	8JA 001 930-001	3 051602 R91	8HG 002 247-001	0 707517 7	8GM 002 091-131	Claas	
0 352 170 005	8JA 001 930-001	3 053497 R91	9EL 088 538-001	0 707596 4	8JA 001 909-001	100 221 45	Hella
0 352 320 001	8JA 001 925-001	3 053498 R91	9EL 088 538-001	0 707658 8	1GB 007 145-101	100 221 46	8GH 007 157-241
0 352 321 007	8JA 004 667-001	3 053 586 R91	9EL 088 525-001	0 707658 8	1GB 007 145-107	100 222 55	2BA 008 221-001
7 781 999 002	8XT 002 117-001	3 059695 R91	2AA 001 201-011	0 708108 7	2XS 005 020-077	100 222 55	8GA 006 841-241
7 781 999 300	8XT 002 121-001	3 118 665 R2	2BA 001 227-201	0 708801 1	8GP 002 095-241	001 005 70	2SA 003 236-041
7 781 999 305	9XS 027 639-001	3 118 665 R2					



Manufacturer's no. / Hella no.

Cross-Reference

Claas	Hella	Claas	Hella	DAF	Hella	DAF	Hella
013 733 0	1GA 007 506-001	551	8JA 003 526-001	125 0158	8GA 002 083-251	135 4893	8GJ 002 525-281
013 733 0	1GA 007 506-002	057 097 51	1G4 003 470-051	125 2218	9XB 136 202-005	135 4894	8GA 002 071-271
013 733 0	1GA 007 506-007	057 098 30	3AF 003 399-051	126 2815	9ES 140 721-015	135 4895	8GA 002 071-261
001 373 50	1GA 007 506-001	058 368 20	1LA 993 975-037	126 2816	9ES 140 722-015	135 4896	8GP 002 067-261
001 373 50	1GA 007 506-002	058 368 30	1LA 993 975-047	127 2653	9EL 152 889-001	135 7075	2VD 008 204-251
001 373 50	1GA 007 506-007	058 489 90	2KA 003 738-057	128 0716	2KA 003 389-061	135 7076	2VP 008 204-241
001 375 90	1GA 007 506-061	059 157 10	2BA 003 389-062	128 0716	2KA 003 389-062	135 7426	2BA 007 135-011
001 378 70	1LA 996 127-017	059 157 20	2SD 003 182-051	128 0716	2KA 003 389-068	135 8193	2XS 955 232-001
00143290	1NA 008 283-001	059 157 30	2SD 003 182-057	128 3167	2SD 001 685-231	135 8201	8KA 962 886-001
001 452 90	1LB 007 145-047	059 157 30	2SD 003 182-061	128 3167	2SD 001 685-232	135 8320	8HG 006 294-041
001 478 90	2XS 955 232-001	059 157 30	2SD 003 182-067	128 3168	2SE 001 685-221	135 8321	8HG 006 294-021
001 478 91	2XS 955 232-017	059 157 40	8RA 003 326-001	128 3168	2SE 001 685-227	135 8779	2RL 006 846-001
001 486 40	1GA 998 522-011	059 157 40	8RA 003 326-002	128 3169	9EL 113 324-001	135 8780	2RL 006 846-011
001 488 00	8GS 009 028-021	059 197 30	9EL 110 536-001	128 3241	1LG 005 480-075	135 8781	9EL 859 020-001
001 488 60	2BA 008 221-001	059 197 40	9EL 118 614-011	128 3243	1LG 005 480-031	135 8782	9EL 950 315-061
001 488 60	2BA 008 221-007	059 510 10	2KA 001 386-231	128 3244	1LG 005 480-041	135 8783	9EL 950 315-001
001 488 60	2BA 008 221-107	059 538 50	8JA 001 909-001	128 9261	2XW 002 897-041	135 8784	9EL 950 315-031
001 488 70	2PF 008 221-011	059 771 30	1LB 996 157-201	129 1216	2VD 008 204-051	1358785	8KA 962 886-001
001 488 70	2PF 008 221-017	059 846 10	2ZR 964 169-031	129 3364	1LG 007 660-111	135 8786	2VP 007 907-031
001 488 70	2PF 008 221-177	059 846 10	2ZR 964 169-037	129 3365	1LG 007 660-121	135 8786	2VP 007 907-037
00148880	1GL 008 090-201	059 879 90	1LB 996 157-201	129 3370	1LG 007 660-031	135 8787	2VP 007 907-041
00148880	1GL 008 090-207	060 405 30	2BM 002 652-031	129 3371	1LG 007 660-041	135 8787	2VP 007 907-047
001 489 30	1GA 996 083-011	060 605 30	2BM 002 652-031	129 9751	1F8 006 800-191	135 8788	9EL 150 965-001
001 489 40	1GA 996 083-011	062 228 60	2JA 006 447-041	129 9752	1N8 006 800-001	135 8789	9EL 150 966-001
001 489 80	2SD 964 169-111	062 289 70	9AL 132 293-027	130 0835	8HG 116 741-801	135 8790	2KA 007 929-001
001 489 80	2SD 964 169-117	062 289 80	2BE 003 347-001	130 1368	2BA 005 481-011	135 8790	2KA 007 929-007
001 556 40	1GA 996 161-121	062 438 72	2SA 001 259-751	130 1758	8JB 001 943-001	135 8791	2XS 955 260-001
001 556 90	1GL 008 090-201	062 438 72	2SA 001 259-757	130 1760	8JA 001 930-001	135 8791	2XS 955 260-007
001 556 90	1GL 008 090-207	062 455 90	2BE 001 259-061	130 2721	2PS 004 361-001	135 9738	8GP 003 594-251
001 586 00	1GA 998 522-037	062 456 00	2SB 001 259-261	130 2721	2PS 004 361-007	135 9951	8GA 002 073-251
001 615 30	2SD 344 169-037	062 558 60	2JA 006 447-041	130 2722	2PG 004 361-011	135 9952	9EL 122 772-001
001 634 60	4DN 009 492-101	062 571 90	1GB 006 213-111	130 2722	2PG 004 361-017	135 9953	2SK 003 567-321
001 664 50	1GO 996 176-131	062 571 90	1GB 006 213-117	130 2723	2TM 004 361-021	135 9954	2SK 003 567-331
001 673 10	9GH 158 051-007	062 591 40	1GB 006 213-101	130 2724	9EL 114 401-001	135 9956	2XW 007 146-001
001 684 50	9GT 134 655-007	062 591 40	1GB 006 213-107	130 2725	9EL 114 401-031	135 9959	1GA 005 060-001
001 720 70	2PF 006 717-011	6-27906100020	8GA 002 071-251	130 2726	9EL 114 401-041	135 9960	2SA 962 964-091
001 758 00	8GS 007 949-101	064 398 00	2XS 005 020-021	130 2727	2PS 006 717-031	135 9961	2PG 962 964-051
001 75820	5DV 990 264-001	065 817 70	2SW 003 185-041	130 2727	2PS 006 717-032	135 9961	2PG 962 964-057
017 715 90	9EL 859 020-001	065 817 70	2SW 003 185-047	130 2727	2PS 006 717-037	135 9962	2SA 006 717-001
017 741 00	9EL 088 525-001	065 828 40	1S0 001 430-011	130 2728	2PS 006 717-061	135 9962	2SA 006 717-007
017 775 90	9EL 859 020-001	065 829 50	1G3 005 760-001	130 2728	2PS 006 717-067	135 9963	9EL 141 135-001
017 797 50	9GD 023 639-001	065 840 30	2KA 001 386-281	130 2729	9EL 141 135-031	135 9964	2PF 006 717-011
017 800 20	9EL 088 538-001	006 642 10	2PF 003 014-071	130 4073	2ZR 003 315-041	135 9965	9EL 141 135-011
017 802 10	9EL 119 397-001	006 642 20	2SA 003 014-051	130 4095	9EL 132 404-001	135 9966	2PG 006 717-021
017 802 20	9EL 118 633-001	067 144 00	8RA 002 016-111	130 4096	9EL 132 403-001	135 9966	2PG 006 717-027
021 174 80	8RA 002 014-101	068 225 80	2BA 001 277-021	130 4788	2VP 008 204-161	135 9967	9EL 141 135-021
021 181 50	8JA 003 526-001	068 225 90	2BA 001 277-011	130 4789	2VD 008 204-171	135 9970	2BA 002 939-171
021 223 00	8RA 002 014-081	685 403 0	2KA 001 386-281	131 1220	2XW 007 146-011	136 0045	1F8 147 077-011
021 362 50	9EL 856 418-001	007 153 00	2JA 002 931-031	131 8143	9ES 147 313-011	136 0046	9AC 141 819-001
021 362 70	9DX 859 560-001	007 169 40	1G4 004 480-011	131 8145	9ES 147 314-011	136 0047	1N8 142 350-011
021 400 50	9EL 147 747-001	073 639 60	9GH 126 647-011	131 8151	9ES 147 315-015	136 0086	1F8 147 350-051
021 400 50	9EL 147 747-007	007 463 20	1GA 998 522-011	131 8152	9ES 147 316-015	136 0087	1F8 148 131-011
021 400 60	9GD 087 883-355	075 107 10	2SD 003 167-011	132 8860	9BG 147 497-002	136 0088	9AC 147 939-021
2145	9GH 993 988-007	075 107 30	2SD 003 167-021	132 8861	9BG 147 498-002	136 7166	9GH 096 532-001
021 576 50	8GP 003 594-121	007 752 00	2RL 006 846-001	133 5901	1GA 007 506-011	137 5936	2PF 007 205-001
021 642 20	8GH 007 157-121	007 752 10	8JB 850 434-011	133 5901	1GA 007 506-012	137 5936	2PF 007 205-007
021 645 30	8GH 008 357-001	007 752 20	9GH 096 532-001	133 6853	2RL 007 550-011	137 8137	2PS 962 964-012
216 609.0	8GA 002 071-121	007 776 20	2TM 006 717-047	134 1734	1G4 003 470-031	137 8137	2PS 962 964-018
021 889 50	1GA 007 506-111	07946400	2KA 003 389-061	134 4984	2PF 001 259-631	138 2999	2KA 001 386-231
021 889 50	1GA 007 506-431	07946400	2KA 003 389-062	134 6293	8HG 006 294-011	138 2020	1NE 006 300-051
023 384 90	2SW 003 014-131	07946400	2KA 003 389-068	135 0426	2PS 007 943-011	138 4518	9EL 116 771-031
002 338 50	2BE 003 014-251	817 623 8	2JA 001 364-001	135 0426	2PS 007 943-017	139 1259	2SA 001 259-751
002 338 50	2BE 003 014-257	081 969 81	8RW 341 235-007	135 0427	2PS 007 943-021	139 1259	2SA 001 259-757
023 385 00	2BE 003 014-251	083 529 40	2PF 003 563-177	135 0427	2PS 007 943-027	139 9200	2NE 003 315-011
023 385 00	2BE 003 014-257	836 254.0	2BA 003 014-011	135 0428	2PS 963 639-011	139 9392	9EL 119 977-001
023 828 81	2JA 003 231-001	084 625 10	8RA 002 014-101	135 0428	2PS 963 639-017	139 9393	2ZR 003 315-041
023 875 20	2PF 001 259-631	875 059 030353	2SD 002 582-011	135 0429	2PS 963 639-071	142 7048	2PF 003 057-041
026 299 10	1GB 996 080-021	875 059 030353	2SD 002 582-017	135 0429	2PS 963 639-077	142 7049	2SA 003 057-021
0310 4840	8RA 003 326-031	875 059 030354	2SD 002 582-021	135 3664	8JB 850 434-011	142 7050	2PF 001 648-161
031 802 20	2BN 964 169-051	875 059 030354	2SD 002 582-027	135 3665	9GH 096 532-001	142 7051	2BA 003 014-111
031 802 20	2BN 964 169-057	908 430 301	2JA 003 232-001	135 4854	8GP 003 594-121	142 7052	1F8 006 800-221
031 802 30	2BA 964 169-041	091 730 10	1G5 003 241-071	135 4855	8GP 002 095-241	142 7053	2SD 001 699-061
031 802 30	2BA 964 169-047	092 959 20	8JA 001 914-011	135 4856	8GM 002 091-121	142 7054	2SD 001 699-511
031 802 40	2TA 964 169-061	940 350 0	9EL 950 315-001	135 4857	8GM 002 091-241	142 7058	2KA 997 011-021
031 802 40	2TA 964 169-067	940 351 0	9EL 950 315-031	135 4858	8GH 002 089-133	142 7059	9EL 109 139-001
031 806 20	2KA 003 389-061	094 079 70	9EL 136 833-001	135 4860	8GH 002 857-241	142 7061	9EL 117 330-001
031 806 20	2KA 003 389-062	094 576 20	2PF 001 634-001	135 4861	8GP 003 594-141	142 7062	9EL 108 435-001
031 806 20	2KA 003 389-068	094 576 40	2SD 002 776-241	135 4862	8GM 002 092-121	142 7063	9EL 135 266-001
031 832 20	2BN 964 169-051	094 576 40	2SD 002 776-247	135 4863	8GM 002 092-241	142 7064	9EL 109 208-011
031 832 20	2BN 964 169-057	094 576 60	2SE 002 776-211	135 4864	8GM 002 091-131	143 5116	2KA 001 386-281
031 832 30	2BA 964 169-041	094 576 60	2SE 002 776-217	135 4865	8GA 002 071-121	143 5134	9EL 122 699-021
031 832 30	2BA 964 169-047	096 341 40	2SD 003 409-201	135 4866	8GA 002 071-241	143 5318	8JB 001 933-031
031 832 40	2TA 964 169-061	096 341 40	2SD 003 409-207	135 4867	8GP 002 068-121	143 5321	

Manufacturer's no. / Hella no.

Cross-Reference



DAF	Hella	DAF	Hella	DAF	Hella	DAF	Hella
152 2243	2SD 003 182-051	152 7648	2AB 004 532-061	083 7246	9EL 856 418-001	086 7550	8RA 003 326-031
152 2243	2SD 003 182-057	152 7651	6EB 005 633-001	083 7247	9EL 856 416-001	086 7551	8RA 003 326-051
152 2278	2VD 008 204-191	152 7662	9EL 343 143-011	088 3764	2AB 004 532-051	086 7553	8RA 964 292-001
152 2301	2VD 008 204-151	152 7663	9EL 343 142-001	008 3764	2AB 004 532-057	086 7556	9BG 119 721-001
152 2302	2VD 008 204-141	152 7838	2XS 008 479-051	084 1885	8RA 002 010-011	086 7557	9BG 121 587-031
152 2386	2VD 008 204-091	152 7838	2XS 008 479-057	084 1981	1G4 003 470-001	086 7557	9BG 121 587-037
152 2387	2VP 008 204-081	152 7962	2PG 008 645-961	084 1981	1G4 003 470-011	086 7558	9EL 107 368-001
152 3548	2VP 006 040-121	152 7962	2PG 008 645-967	084 4501	2XW 002 897-051	086 7559	9EL 111 647-001
152 3548	2VP 006 040-127	153 6974	2JA 004 531-001	084 6006	2XS 950 071-031	086 7560	9EL 117 334-001
152 3987	1F3 009 094-031	161 6169	2RL 008 061-101	008 582017	1N0 008 582-011	086 7561	9EL 118 700-001
152 4085	9EL 147 097-001	162 2273	1F8 007 560-131	008 582017	1N0 008 582-017	086 7562	9EL 118 701-001
152 4090	2VD 005 300-551	162 2671	2SL 003 567-311	086 182	2PS 963 639-111	086 7563	9EL 119 544-021
152 4091	2VD 005 300-581	162 3563	1FE 002 537-191	086 579	9EL 990 034-051	086 7568	9EL 137 241-001
152 4092	9EL 134 301-011	162 3564	2ZR 001 193-011	086 5792	2BA 001 259-611	086 7569	9EL 146 838-001
152 4093	9EL 145 103-011	162 4964	2KA 006 896-001	086 5792	2BA 001 259-618	086 7570	9EL 146 838-001
152 4094	9EL 145 104-011	162 4964	2KA 006 896-007	086 5814	9EL 088 150-001	086 7571	9EL 147 747-001
152 4097	2SB 009 362-011	162 5985	2VD 008 204-251	086 6069	2SK 008 208-051	086 7571	9EL 147 747-007
152 4100	2BA 009 001-107	162 5986	2VP 008 204-241	086 6416	1FE 008 773-061	086 7572	9EL 147 910-001
152 4101	2ZR 009 001-011	163 6919	5DV 008 856-001	086 6417	1FE 008 773-041	086 7573	9EL 148 274-001
152 4101	2ZR 009 001-017	163 6919	5DV 008 856-007	086 7068	2RL 007 900-611	086 7576	9EL 963 984-001
152 4337	2SK 005 883-011	163 7337	8GH 007 157-121	086 7142	2KA 001 378-001	086 7577	9EL 964 289-001
152 4392	2BA 008 221-001	163 7338	8GH 007 157-241	086 7428	1FB 005 860-031	086 7578	9EL 964 290-001
152 4392	2BA 008 221-007	164 4058	2RL 008 061-111	086 7429	1FE 006 300-261	086 7579	9EL 990 034-051
152 4393	2ZR 008 221-051	165 984	9EL 102 240-031	086 7430	1FE 138 520-011	086 7584	9GD 963 281-001
152 4393	2ZR 008 221-057	166 0613	9GD 863 033-001	086 7433	2AB 004 532-001	086 7585	9XD 997 909-801
152 4394	2XA 008 221-021	166 5750	9GH 156 191-001	086 7434	2AB 004 532-011	086 7588	1G4 997 033-011
152 4394	2XA 008 221-027	166 5752	5DD 008 319-501	086 7435	2XM 001 974-131	086 7589	1GA 006 991-051
152 4396	1FA 008 284-011	167 1839	2XT 009 098-017	086 7437	6ZN 160 705-001	086 7590	1GA 998 532-011
152 4399	8HG 160 409-002	167 8624	2XM 001 974-151	086 7439	8XT 863 316-001	086 7591	2KA 001 386-291
152 4400	2PS 008 645-601	168 3694	1GA 007 506-021	086 7440	9DF 112 246-001	086 7593	2PG 008 645-631
152 4400	2PS 008 645-607	168 4027	8JD 008 151-011	086 7444	1G3 003 710-021	086 7594	2SD 997 005-021
152 4401	1GM 996 134-171	169 9302	1LJ 247 046-051	086 7445	1G4 003 470-051	086 7595	2TM 006 717-047
152 4403	2NE 008 221-031	169 9303	1LJ 247 046-061	086 7446	1GA 006 876-001	086 7597	9BG 101 230-001
152 4403	2NE 008 221-037	169 9305	1LJ 247 046-071	086 7447	1GA 006 991-021	086 7598	9EL 118 613-001
152 4404	2XA 008 221-021	169 9306	1LJ 247 046-081	086 7448	1GA 006 991-041	086 7599	9EL 134 658-001
152 4404	2XA 008 221-027	169 9435	9EL 862 141-001	086 7449	1GA 006 991-091	086 7600	9EL 134 739-001
152 4405	8KA 152 134-007	1725270	1PE 965 410-111	086 7450	1GA 007 506-001	086 7601	9DX 859 626-001
152 4432	8XU 009 362-111	1725271	1PE 965 410-121	086 7450	1GA 007 506-002	086 7601	2ZR 002 985-261
152 4433	8XU 009 362-101	1725272	1PE 965 410-131	086 7450	1GA 007 506-007	086 8179	9EL 147 096-001
152 4434	9HB 163 085-012	1725273	1PE 965 410-141	086 7451	1GA 998 525-001	086 8182	2PS 963 639-111
152 4435	9HB 161 122-012	173 1959	2PS 008 645-001	086 7452	1S3 001 117-041	086 8217	9EL 152 891-001
152 4449	9XD 161 119-007	173 1959	2PS 008 645-007	086 7454	2BA 007 135-001	086 8226	1LG 003 434-187
152 4450	8JD 156 150-807	173 5534	8GS 861 955-021	086 7455	2BM 006 692-021	086 8227	1LG 007 150-121
152 4451	2SD 001 685-347	017 3732	2PF 001 647-031	086 7455	2BM 006 692-027	086 8229	2VD 008 204-111
152 4639	1GA 996 083-021	017 3732	2PF 001 647-037	086 7456	2BM 009 320-807	086 8230	2VP 008 204-101
152 4704	2RL 008 183-111	017 6043	8GA 002 073-241	086 7457	2JA 004 531-011	086 8288	2VD 007 323-131
152 4725	2RL 008 181-111	027 3336	1G4 003 470-031	086 7458	2JA 007 372-001	086 8289	2VD 007 323-141
152 4735	1F8 009 797-021	028 8326	4AZ 003 787-021	086 7459	2KA 001 389-101	086 8290	2VP 007 323-091
152 4736	1F8 009 797-031	029 9634	2BA 001 416-011	086 7460	2KA 002 445-111	086 8291	2VP 007 323-101
152 4795	9EL 152 884-001	029 9635	2BA 001 416-021	086 7461	2KA 003 389-001	086 8293	2ZR 964 169-511
152 4886	2SE 997 005-011	343 640071	2VA 343 640-071	086 7462	2KA 003 389-211	086 8293	2ZR 964 169-517
152 5168	8GA 002 073-271	343 640071	2VA 343 640-077	086 7462	2KA 003 389-217	086 8295	2SD 964 169-411
152 5177	9EL 152 889-001	038 4985	1LG 005 480-031	086 7464	2NE 003 236-001	086 8296	2NE 964 169-021
152 5205	2VP 008 789-021	038 4986	1LG 005 480-041	086 7464	2NE 003 236-008	086 8296	2NE 964 169-027
152 5206	2VD 008 789-011	038 4988	2BA 005 481-001	086 7465	2PF 959 570-401	087 1191	2PS 003 057-051
152 5296	2RL 007 337-011	038 5313	1F6 003 939-031	086 7465	2PF 959 570-407	087 1191	2PS 003 057-057
152 5749	1FB 007 892-071	038 5317	2BA 005 407-001	086 7466	2PF 959 590-401	087 1201	1GA 007 506-081
152 5750	1FB 007 892-131	046 7569	9EL 146 491-001	086 7466	2PF 959 590-407	087 1215	2RL 007 900-001
152 5751	1F4 007 893-191	053 2655	2SE 001 688-151	086 7467	2PF 959 590-411	087 1567	2PS 340 001-011
152 5753	2PS 008 645-611	053 4597	8GA 002 071-251	086 7467	2PF 959 590-417	087 1569	9XX 340 220-011
152 5753	2PS 008 645-617	055 2953	8HG 002 365-001	086 7468	2PG 003 057-011	087 1659	9EL 115 830-001
152 5754	2PS 008 645-621	055 7060	2BA 003 014-111	086 7468	2PG 003 748-151	087 1782	1LG 006 679-051
152 5754	2PS 008 645-627	055 7096	2KA 001 378-041	086 7470	2PG 962 964-041	087 4783	1LG 006 898-051
152 5785	2TM 008 645-651	056 0333	2PF 001 259-631	086 7471	2PG 963 639-401	087 4784	1LG 006 898-091
152 5800	1NL 007 186-061	056 3047	2SE 001 685-201	086 7472	2PS 003 748-121	087 4785	1LG 007 150-111
152 5800	1NL 007 186-067	056 3048	2SD 001 685-211	086 7472	2PS 003 748-127	087 4883	1EL 145 103-011
152 6004	2BE 003 185-031	056 3048	2SD 001 685-218	086 7473	2PS 003 748-161	087 4884	9EL 145 104-011
152 6141	2RL 007 900-201	057 4235	2PF 001 648-171	086 7473	2PS 003 748-167	087 4884	9EL 147 096-031
152 6142	2RL 007 900-211	0614367	2ZR 001 423-001	086 7474	2PS 006 717-061	087 8909	9EL 147 096-021
152 6158	9EL 136 825-001	062 1969	8JA 001 915-001	086 7474	2PS 006 717-067	087 8984	2XS 963 959-031
152 6159	9EL 136 825-011	627 296	2NE 001 423-011	086 7480	2PS 963 639-157	087 8984	2XS 963 959-037
152 6168	2VP 006 040-111	063 3406	9GH 096 532-001	086 7481	2RL 007 337-001	087 8985	9EL 856 010-001
152 6168	2VP 006 040-117	064 1800	2JA 003 231-001	086 7482	2RL 008 060-111	087 8986	2XS 004 237-311
152 6377	2VA 343 640-071	006 6613	9DS 121 707-001	086 7483	2SB 003 014-151	087 8995	2SA 003 734-121
152 6377	2VA 343 640-077	006 6614	6ED 708 919-001	086 7484	2SD 001 680-271	087 8998	1F8 006 800-311
152 6378	2VP 343 640-021	006 6691	9HD 121 297-001	086 7485	2SD 001 680-281	087 8999	2PT 008 935-811
152 6378	2VP 343 640-027	006 6698	2BA 005 481-001	086 7486	2SD 003 184-031	087 9000	1LB 003 177-511
152 6479	2JB 343 227-001	006 6733	9ES 133 572-005	086 7486	2SD 003 184-037	087 9047	9EL 136 819-031
152 6522	1NE 138 555-011	006 6734	9DE 133 697-015	086 7487	2SD 003 184-041	087 9082	2SE 997 008-001
152 6716	5DS 009 552-011	006 7392	2XS 950 071-031	086 7487	2SD 003 184-047	087 9085	9EL 997 332-001
1526763	2SE 001 680-301	067 6003	2JA 003 354-001	086 7488	2SE 001 685-221	087 9100	2ZR 005 860-151
152 6764	2SE 001 680-291	069 2279	9EL 101 353-001	086 7488	2SE 001 685-227	087 9101	2ZR 997 506-391
152 6858	1GA 996 142-011	069 2421	2XW 003 146-001	086 7489	2SE 002 578-701	087 9102	2ZR 005 700-191
152 6897	4RA 003 530-051	069 2705	9ES 106 588-001	086 7489	2SE 002 578-707	087 9122	1F8 007 560-311
152 6974	2JA 004 531-001	069 4231	1G5 003 241-081	086 7490	2SE 007 547-041	087 9123	1F8 007 560-301



Manufacturer's no. / Hella no.

Cross-Reference

DAF	Hella	Evobus	Hella	Evobus	Hella	Faun	Hella
088 2014	2PS 007 943-321	002 544 01 90	9EL 119 544-021	7 552 026 000 0	2ZR 002 589-011	5240-495	2BA 003 236-321
088 2064	9EL 117 330-011	002 820 05 01	2AB 001 208-001	7 552 026 004 0	9EL 112 858-011	5240-496	2SA 003 236-341
088 2065	9EL 117 334-021	002 820 47 56	2PF 006 679-007	7 552 030 000 0	2JA 001 331-011	5240-497	2DA 003 236-331
088 2083	8RA 004 412-001	002 820 57 56	2XS 003 168-071	7 553 016 000 0	2JA 004 531-011	5240-498	2ZR 003 236-311
088 2084	8RA 004 412-011	003 542 47 20	3AF 003 399-061	7 556.012.002.0	2AB 004 532-051	5240-499	2NE 003 236-301
088 2085	8RA 004 412-021	370 820 00 50	1GB 996 080-011	7.556.012.002.0	2AB 004 532-057	5240-499	2NE 003 236-307
088 2235	2BA 008 260-001	370 821 00 65	8JA 002 263-031	7 556 012 003 0	2AB 004 532-051	5240-514	2SA 961 167-011
088 2235	2BA 008 260-007	372 820 00 39	2PT 008 935-801	7 556 012 003 0	2AB 004 532-057	5240-536	2NE 003 236-008
088 2236	1NE 008 773-031	372 826 00 31	9XD 127 264-007	7 556 012 003 0	9XB 136 202-005	5240-536	2NE 003 236-008
088 2331	2VD 003 567-377	372 826 00 47	2PF 004 081-001	7 740 000 021	9GH 096 532-001	5240-928	2RL 006 846-011
088 7342	9XD 863 828-001	372 826 00 56	2PF 004 081-007	000 820 04 57	2DA 959 071-737	5240 929	8HG 006 294-051
088 7400	2PF 959 590-411	003 820 01 56	2DA 959 071-237	000 820 10 20	2BM 008 355-001	5241-058	2VP 007 323-091
088 7400	2PF 959 590-417	003 820 01 56	2DA 959 071-737	000 820 10 20	2BM 008 355-007	5241-059	2VP 007 323-101
088 7639	1F8 009 797-121	003 820 13 15	2XS 005 020-001	000 820 18 60	2KA 001 388-051	5241-288	2ZR 004 542-001
088 7640	1F8 006 800-341	003 820 13 15	2XS 005 020-002	000 820 25 68	2DA 001 240-341	5241-379	8GP 003 594-241
088 7685	2BA 964 169-501	003 820 13 15	2XS 005 020-003	000 820 36 66	9EL 119 544-212	5241-380	2PS 006 717-031
088 7685	2BA 964 169-507	003 820 13 56	2XS 005 020-001	000 820 37 21	2BA 004 119-001	5241-380	2PS 006 717-037
088 8487	9EL 862 141-021	003 820 13 56	2XS 005 020-002	000 820 39 66	2AA 003 257-041	5241-380	2RL 007 551-011
088 8539	1FE 008 773-001	003 820 13 56	2XS 005 020-003	000 820 39 66	2AA 003 257-042	5241-401	9EL 119 544-021
088 8540	1GM 996 136-131	003 820 14 15	2XS 005 020-077	000 820 41 64	2SB 001 423-097	5241-472	9EL 119 544-031
088 8541	1FE 006 300-041	003 820 14 56	2XS 005 020-077	000 820 59 56	2NE 001 423-011	5241-473	9EL 119 544-031
088 8550	2PF 009 001-521	003 820 15 56	2KA 005 049-011	000 820 63 01	2JA 003 115-001	5241-474	9EL 120 201-001
088 8551	2SB 009 001-501	003 820 15 56	2KA 005 049-017	000 820 90 56	2KA 003 389-061	5242-372	2NE 003 236-301
088 8552	2BA 009 001-511	003 820 16 56	2XS 005 020-001	000 820 90 56	2KA 003 389-062	5242-372	2NE 003 236-307
088 8973	1GM 996 136-191	003 820 16 56	2XS 005 020-002	000 820 90 56	2KA 003 389-068	5242-372	2RL 007 337-011
088 8973	1GM 996 136-192	003 820 16 56	2XS 005 020-003	000 820 95 56	2TJ 003 168-151	5243-536	1GA 007 506-011
088 8977	2BM 006 692-011	003 820 20 56	2PF 959 590-401	000 825 02 03	2KA 001 389-101	5243-536	1GA 007 506-012
088 8977	2BM 006 692-017	003 820 20 56	2PF 959 590-407	000 825 06 03	2PF 004 081-001	5243-537	2ZR 003 315-041
088 8982	8RA 002 020-001	003 820 21 56	2PF 959 590-457	000 826 10 40	2PF 004 081-007	5243-538	2NE 003 315-011
088 8982	8RA 002 020-002	003 820 21 56	2NE 008 221-031	000 826 14 41	8RA 003 660-007	5246-248	2RL 007 337-011
088 8982	8RA 002 020-003	003 820 21 56	2NE 008 221-037	000 826 18 40	2PS 002 727-001	5246-736	2VD 007 547-181
0889009	2XS 007 841-011	003 820 21 56	2NE 008 221-137	000 826 18 40	8RA 003 326-031	5246-762	2NE 002 985-001
0889009	2XS 007 841-017	003 820 26 56	1KO 008 191-212	000 826 26 10	9EL 116 380-045	5246-777	8GD 002 078-241
088 9010	2XS 007 841-021	003 820 27 56	1NO 008 582-042	000 826 27 10	9EL 116 380-035	5246-845	2ZR 002 985-261
088 9010	2XS 007 841-027	003 820 44 56	2XS 008 479-081	000 826 28 97	9GD 128 553-007	5246 911	2VP 007 323-091
088 9013	2PS 964 295-071	003 820 45 56	2XS 008 479-091	000 826 30 47	2SA 001 259-751	5246-950	8RA 003 326-041
088 9013	2PS 964 295-077	003 826 63 90	9EL 119 544-212	000 826 30 47	2SA 001 259-757	5246-950	8RA 003 326-047
904 1381	2XS 950 071-031	000 544 11 04	2NE 003 236-001	000 826 42 47	2PF 001 259-631	52471-61	2RL 008 181-111
090 6104	2BA 001 277-011	000 544 11 04	2NE 003 236-008	000 827 00 10	5DS 009 602-001	5247 258	1ND 005 700-061
090 6126	2PS 963 639-091	000 544 11 04-00	2NE 003 236-001	000 827 07 31	9GH 152 654-007	5247 259	8GH 002 090-251
090 6127	2PS 963 639-031	000 544 11 04-00	2NE 003 236-008	000 827 08 31	9GH 158 051-007	5247 259	8GH 002 090-253
090 6127	2PS 963 639-037	000 544 18 04	2NE 003 236-301	000 997 32 86	9GH 096 532-001	5247 605	1GD 005 700-501
090 6130	2SB 001 240-311	000 544 18 04	2NE 003 236-307	000 998 57 05	9GT 137 236-007	5247 653	2SE 007 547-041
090 6131	2BA 003 022-021	000 544 18 04-00	2NE 003 236-301	HXB 373 820 17 64	2SA 003 236-041	5247 757	2ZR 997 506-391
090 6180	4RA 965 400-001	000 544 18 04-00	2NE 003 236-307	HXB 373 820 17 64	2SA 003 236-047	5247-915	2VA 343 640-117
090 6185	4RD 933 332-041	000 544 20 34	2KA 003 010-007	HXB 373 820 17 64	2SA 003 236-048	5247-916	2VA 343 640-207
090 6194	2PG 008 645-641	000 544 24 07	2ZR 003 236-051	HXB 373 820 18 64	2DA 003 236-031	524951	2KA 003 389-061
090 6242	2SB 009 362-021	000 544 24 07	2ZR 003 236-057	HXB 373 820 18 64	2DA 003 236-037	524951	2KA 003 389-062
090 6488	1GA 007 506-681	000 544 33 07	2ZR 003 236-311	HXB 373 826 15 10	9EL 119 544-031	524951	2KA 003 389-068
090 6515	2PF 340 000-111	000 544 37 34	2KA 003 168-021	NO 000000 003884	8GP 008 285-001	0552-315	2BA 002 652-111
090 6519	2PG 340 000-121	000 544 40 11	2XS 007 841-021	N072601024900	8GP 002 067-241	0552-315	2BA 002 652-117
090 6521	2PS 340 000-011	000 544 40 11	2XS 007 841-027			5641 110	9EL 146 887-001
090 6522	2PS 340 000-021	000 544 48 11	2PS 963 639-111			5641-476	2SD 344 100-101
090 6523	2PS 340 000-041	000 544 77 02	9BG 121 740-001			0576-427	2BA 002 652-101
090 6558	2TM 008 645-941	000 545 82 26	8JB 850 434-011			0576-427	2BA 002 652-107
090 6558	2TM 008 645-947	000 585 11 03	8XH 002 975-011			6254 93	2XS 955 031-001
090 6595	2VP 340 888-001	612 820 00 56	2KA 005 049-008			7000-939	2PS 006 717-031
090 6595	2VP 340 888-007	612 820 00 56	2KA 005 049-011			7000-939	2PS 006 717-032
090 6596	2VP 340 888-011	612 820 00 56	2KA 005 049-017			7000-939	2PS 006 717-037
090 6596	2VP 340 888-017	612 820 01 20	2BM 008 355-001			7004-770	2SA 001 259-751
090 6603	2VP 343 640-081	612 820 01 20	2BM 008 355-007			7004-770	2SA 001 259-757
090 6603	2VP 343 640-087	613 826 02 41	2PS 962 964-031			7005-086	1G3 005 760-011
090 6606	2VP 343 640-247	613 826 02 41	2PS 962 964-037			7300-981	9EL 856 416-001
090 6607	2VP 343 640-257	627 820 00 20	2BA 996 027-001			7301 861	9EL 122 689-021
090 6612	2XS 008 479-041	6 290 010 089 1 14	2PF 004 081-001			7482 62	1GA 007 506-001
090 6612	2XS 008 479-047	6 290 010 089 1 14	2PF 004 081-007			7482 62	1GA 007 506-002
090 6632	2ZR 996 179-701	6 29 001 0089 1 24	9XD 127 264-007			7482 62	1GA 007 506-007
090 6633	2ZR 996 506-501	629-00.40.500-10.4	2PT 008 935-801			7723-461	1KB 003 177-061
090 6639	9EL 119 544-001	666 820 03 56	2PF 003 563-151			7723 582	2XS 005 020-077
090 6641	9EL 132 215-001	671 820 04 56	2KA 006 896-001			7723 802	2VP 003 567-111
090 6646	9MN 858 114-011	7.312.018.000.0	2KA 006 896-007			7723 803	2VP 003 567-121
090 6648	9XD 130 261-001	7 512 129 012 0	6ED 004 778-001			7723 803	2VP 003 567-127
090 6792	2ZR 003 236-051	7 513 114 000 0	1VB 005 444-037			7730 123	1LB 003 177-081
090 6792	2ZR 003 236-057	7 515 115 000 0	1NB 003 367-137			7730-968	8HG 006 294-041
090 6794	2RL 008 183-101	7.515.115.004.0	2ZR 002 694-001			7751 228	1G3 005 760-011
090 7333	9EL 990 633-031	7.515.116.000.0	9EL 113 928-001			7751-492	2PF 006 679-007
090 7334	9EL 990 633-041	7 521 123 000 0	2ZR 001 240-351			8412-667	2SD 001 699-001
090 7365	2PS 008 645-991	7 521 128 004 0	2BA 001 277-021			8412-695	2BE 003 014-251
090 7385	9MN 862 741-001	7 521 145 000 0	9EL 115 830-001			8412-695	2BE 003 014-257
X54 565	2BA 003 022-021	7 521 145 000 0	2BA 003 236-021			8412 719	8RA 002 014-051
X94 684	2KA 003 168-021	7 521 146 000 0	2BA 003 236-027			8412 719	8RA 002 014-052
		7 521 146 000 0	2BA 001 240-301			8413-122	2JA 003 231-001
		7 521 146 000 0	2BA 001 240-301			8464-239	2PS 004 361-001
		7 521 148 000 0	2BM 002 847-011			8464-239	2PS 004 361-007
		7.521.149.000.0	2BM 002 847-021			8464 789	2PF 003 014-071
		7.534.113.000.0	2PF 001 638-011			8464-953	2AB 004 532-051
		7 534 113 017 0	9GD 100 140-001			8464-953	

Manufacturer's no. / Hella no.

Cross-Reference



Faun	Hella	Faun	Hella	Fendt	Hella	Fendt	Hella
9970-0243668	8GA 002 073-241	99708464301	2XS 005 020-017	E 400 026	2KA 004 525-001	X 825 283 230	8GP 002 066-121
99700339959	8GM 002 094-241	99708464788	2PF 003 389-030	E 400 034	8HG 002 365-001	X 825.283.248.000	8GA 002 525-131
99700524951	2KA 003 389-061	9970-8464789	2PF 003 014-071	F 013 900 020 030	9KS 075 139-001	X 825.283.253.000	8GP 002 067-121
99700524951	2KA 003 389-062	9970 8464953	2AB 004 532-051	F 015 900 020 211	9DR 060 567-001	X 825.283.254.000	8GP 002 067-121
99700524951	2KA 003 389-068	9970 8464953	2AB 004 532-057	F 015 900 020 230	9GD 024 183-001	X825283262	8GA 006 841-121
99700552314	2BA 002 652-121	9970-8467024	9EL 110 542-001	F 024 900 020 040	1S3 001 117-041	X825283263	8GD 002 078-121
99700552314	2BA 002 652-127	9970-8467134	9EL 116 907-001	F 024 900 020 070	9ES 015 675-001	X 825.283.277.000	8GA 006 841-121
99700552315	2BA 002 652-111	9970 8467201	9BG 121 587-031	F 024 900 020 120	9FF 090 500-001	X 825.283.286.000	8GH 002 090-133
99700552315	2BA 002 652-117	9970 8467201	9BG 121 587-037	F 112 900 020 070	9GD 023 639-001	X 825.283.291.000	8GM 002 091-131
99700576427	2BA 002 652-101	9970-8475136	2BA 003 014-011	F 112 900 020 261	9DR 090 206-001	X 825.283.299.000	8GA 002 073-121
99700576427	2BA 002 652-107	9970-8476344	2XS 955 031-001	F 112 900 020 270	1S0 001 430-011	X 825.283.480.000	8GS 009 028-021
9970-0726421	8GP 003 594-241	99708519965	2SA 003 057-021	F 112 900 020 280	9ES 012 060-011	X 830 108 003 5010	9EL 108 435-001
99700760569	2ZR 003 014-091	99708520062	2PF 003 057-041	F 112 900 030 270	1S0 001 430-011	X 830 108 035 010	9EL 108 435-001
99700971531	1G5 003 241-021	9970-8520690	9EL 117 330-001	F 116 902 020 080	9KS 075 307-001	X 830 160 001 020	9GD 052 710-021
99700987118	8HG 002 365-001	9970-8520691	9EL 117 330-011	F 140 901 020 020	8JA 001 909-001	X 830 160 001 060	9FF 085 642-001
9970-1438216	9EL 134 659-001			F 140 901 020 020	8JA 001 909-011	X 830 160 100	1GD 003 690-287
99701438217	9EL 134 660-001			F 199.200.220.010	2AA 003 257-031	X 830 160 100 000	1GD 003 690-287
9970 5467158	9XR 854 840-001			F 210.902.140.010	9EL 860 627-001	X 830 160 101 130	1GA 006 876-001
9970-7000448	1N4 005 750-001			F 225 901 020 030	2ST 001 673-011	X 830 180 001	2BA 002 324-011
9970-7000939	2PS 006 717-031			F 225 901 020 040	2SB 001 673-002	X 830 180 001 010	9EL 110 918-001
9970-7000939	2PS 006 717-032			F 225 901 020 060	9EL 110 928-001	X 830 180 002	2BA 002 324-021
9970-7000939	2PS 006 717-037			F 225 901 100 030	2BA 001 244-001	X 830 180 015 010	9EL 118 633-001
9970-7004770	2SA 001 259-751			F 225 901 100 070	9EL 085 478-001	X 830 180 020	2XW 003 146-001
9970-7004770	2SA 001 259-757			F 228 900 020 010	2BE 001 278-011	X 830 180 030	2JA 001 330-001
9970-7005086	1G3 005 760-001			F 228 900 020 020	2BE 001 278-021	X 830 180 030	2JA 001 330-007
9970-7006297	2BM 006 692-011			F 228 900 020 060	9EL 087 769-001	X 830 180 030 000	2JA 001 330-001
9970-7006297	2BM 006 692-017			F 231 902 140 010	8HG 002 365-001	X 830 180 032	2JA 001 330-007
9970-7006298	2BM 006 692-021			F 231 902 140 040	8GA 002 074-121	X 830 180 032	2BE 003 014-251
99707006623	2SD 002 776-231			F 231 902 140 060	8JB 850 434-011	X 830 180 032	2BE 003 014-257
99707006623	2SD 002 776-237			F 231 902 140 080	9EL 854 912-001	X 830 180 032 000	2BE 003 014-251
99707006624	2SD 002 776-241			F 250 900 020 010	2SA 001 634-121	X 830 180 032 010	9EL 115 003-055
99707006624	2SD 002 776-247			F 312 901 110 040	1GA 998 525-001	X 830 180 033	2PF 001 648-161
9970-7010742	2PS 008 645-001			F 312 901 110 042	9GH 126 647-011	X 830 180 036	2PF 001 648-161
9970-7010742	2PS 008 645-002			F 930.900.020.120	9EL 113 324-001	X 830 180 037	2PF 001 648-161
99707010743	2PS 008 645-021			F 930.900.111.010	8JA 990 065-001	X 830 180 034	2BE 003 014-257
9970-7011463	2RL 008 060-111			F 930.900.111.020	1GA 990 305-001	X 830 180 035	2PF 001 648-161
99707011950	2RL 007 900-511			F 931.901.020.020	9DV 990 264-001	X 830 180 035 010	2PF 001 648-161
9970-7013043	9EL 862 141-001			F 931 901 020 160	9XB 152 977-001	X 830 180 036	9EL 108 435-001
99707013878	2RL 008 183-011			G 210.902.113.010	8KB 990 299-241	X 830 180 036	2BE 002 776-251
99707014602	2VD 007 323-121			G 210.902.140.020	1GM 996 134-321	X 830 180 036 000	2BE 002 776-257
99707014603	2VP 007 323-121			G 246 900 020 050	2RL 007 551-001	X 830 180 037	2BE 002 776-257
99707014709	2RL 007 551-011			G 294 900 110 010	1LB 006 213-057	X 830 180 037	2BE 002 776-267
99707015359	9EL 110 542-001			G 294 900 110 010	1GB 006 213-117	X 830 180 037 000	2BE 002 776-267
9970 7015510	9GH 993 984-001			G 312 900 110 010	1GA 007 506-081	X 830 180 038	2BE 002 776-267
9970 7015528	1GA 996 142-151			G 312 900 110 010	1GA 998 522-011	X 830 180 038	2SD 002 776-231
99707015845	1GA 998 525-001			G 312 900 110 030	1GA 006 991-051	X 830 180 039	2SD 002 776-241
9970 7016349	1GA 990 305-011			G 312 900 110 020	1GB 996 080-011	X 830 180 040	2SD 002 776-247
9970 701 6350	8GS 007 949-101			G 324 900 111 010	8HG 990 003-001	X 830 180 040 000	2KA 001 389-101
9970 7016499	1GA 007 506-431			G334.900.111.020	1GA 007 506-081	X 830 180 041 000	2KA 003 168-021
99707016583	9BG 990 353-001			G334.900.160.010	1LL 009 998-011	X 830 180 042 000	2PF 003 014-071
99707016602	9EL 146 887-001			G 380 902 110 010	1GA 998 522-011	X 830 180 042 010	9EL 110 542-001
99707016603	9EL 146 838-001			G 380.902.110.020	1GA 998 522-011	X 830 180 043	2KA 003 389-061
9970 7017009	2TM 008 645-061			G 524 900 115 020	1GA 007 506-081	X 830 180 043	2KA 003 389-062
9970 7017009	2TM 008 645-067			G650.901.110.010	1ZR 996 176-131	X 830 180 043	2KA 003 389-068
99707017363	2VD 007 323-141			G 650 902 020 050	2ZR 343 130-041	X 830 180 046	2SD 003 184-047
99707017364	2VP 007 323-111			G 650 902 112 010	1GA 996 176-041	X 830 180 046 000	2SD 003 184-041
99707017939	2TM 008 645-071			G 716 900 020 090	2SD 001 685-317	X 830 180 046 010	2SD 003 184-047
99707017939	2TM 008 645-077			G718.970.010.090	8HG 004 806-001	X 830 180 047	9EL 118 701-001
99707018060	2RL 008 183-111			G 737 900 020 050	2BA 009 001-001	X 830 180 047	2SD 003 184-037
9970 7018848	2ZR 997 506-391			G 737 900 020 060	2BA 009 001-007	X 830 180 047 000	2SD 003 184-037
9970 7021893	2SA 962 964-091			G 737 900 020 060	2SB 009 001-061	X 830 180 047 010	2SD 003 184-037
9970 7021899	9GT 963 129-001			G 737 900 020 130	2SB 009 001-067	X 830 180 048	9EL 118 700-001
99707030021	2KA 001 1738-001			G 737 900 020 150	6NM 007 282-221	X 830 180 048	2SE 003 184-011
9970-7300981	9EL 856 416-001			G 916 901 020 010	1GA 996 020-001	X 830 180 048 000	2SE 003 184-017
9970-7301861	9EL 122 689-021			G 916 901 210 010	2TJ 003 168-151	X 830 180 048 000	2SE 003 184-017
99707302238	1G3 135 211-011			G 930.900.111.010	1GA 996 142-021	X 830 180 048 010	9EL 118 697-001
99707305610	9EL 950 315-001			G 931.900.020.120	2BA 008 221-107	X 830.180.063.010	8GH 002 089-133
9970 7307671	9EL 950 315-031			G 931 900 020 130	2BA 008 221-177	X 830 180 063 020	9EL 856 416-001
99707308166	1VB 005 444-037			G 931 900 020 130	2PF 008 221-107	X 830 180 080	2PS 002 727-001
99707723462	2XS 005 020-001			G931.900.020.150	1KO 008 191-011	X 830 180 080	2PS 004 361-001
99707723582	2XS 005 020-002			G931.900.020.150	1KO 008 191-017	X 830 180 085	2PS 004 361-007
99707723582	2XS 005 020-003			G931.901.020.120	2KA 004 331-031	X 830 180 085	2NE 002 985-001
99707723582	2XS 005 020-007			G931.901.020.130	2PF 008 221-177	X 830 180 091 000	2BE 003 347-001
99707723637	2XS 005 020-081			G931.901.020.130	2BA 008 221-107	X 830 180 095	2BE 003 347-001
99707723802	2VP 003 567-111			G931.901.110.010	1GM 996 134-081	X 830 180 095 000	2BE 003 347-001
99707723803	2VP 003 567-127			G931.901.220.030	2KA 004 331-107	X 830 180 095 010	9EL 120 224-001
99707723803	2VP 003 567-127			H 737 900 020 010	8RA 009 001-031	X 830 180 102	2PF 964 295-257
99707730123	1LB 003 177-081			H 737 900 020 010	8RA 009 001-037	X 830 180 102	2XS 005 020-001
9970-7730539	2BA 996 027-001			H 816 810 200 010	2JA 002 931-031	X 830 180 102	2XS 005 020-003
9970-7751204	9XD 130 261-001			H 922.500.410.020	8RW 341 235-007	X 830 180 152	2PS 002 727-001
9970-7751228	1G3 005 760-011			H 931.901.020.080	5DS 009 602-011	X 830 180 152 000	2PS 002 727-001
9970-7751280	8HG 006 294-021			V 310 851 00	9GH 096 532-001	X 830 180 162	2PS 964 295-001
9970-7751492	2PF 006 679-007			V 327 670 00	9JF 126 444-001	X 830 180 162	2PS 964 295-007
9970-7751917	2SE 001 685-201			V 649 791	8BB 001 943-001	X 830 180 165	2PS 962 964-031
9970-7758097	2XS 950 071-031			V692470	2JA 001 330-001	X 830 180 165	2PS 962 964-037
9970-7764767	2XW 007 146-001			V692470	2JA 001 330-007	X 830 180 172	2KA 004 331-061
9970 7798775	2SB 964 169-531			V SH2 638	8GP 002		



Manufacturer's no. / Hella no.

Cross-Reference

Fendt	Hella	Fiat	Hella	Ford	Hella	Ford	Hella
X 830 180 190	2DA 007 421-007	42304486	2DA 003 236-037	1 063 869	9EL 171 556-031	1 127 645	9EL 354 071-011
X 830 180 190	2DA 007 541-001	42304487	2NE 003 236-001	1 063 874	9EL 171 556-041	1 128 752	9EL 171 558-021
X 830 180 193	8KA 146 751-007	42304488	2NE 003 236-008	1 063 878	2NE 354 062-021	1 128 753	9EL 171 558-011
X 830 180 195	2VA 007 502-011	42304488	2ZR 003 236-051	1 063 886	2ZR 354 063-011	1 128 754	9EL 171 558-021
X 830 180 195	2VA 007 502-017	42304488	2ZR 003 236-057	1 065 778	9EL 354 061-021	1 128 755	9EL 354 071-021
X 830 180 195 000	2VA 007 502-011	42317738	2ZR 003 236-051	1 065 780	9EL 354 061-011	1 128 757	9EL 354 071-011
X 830 180 195 000	2VA 007 502-017	42317738	2ZR 003 236-057	1 065 782	9EL 354 057-021	1 130 104	9EL 354 071-021
X 830 180 196	2VP 007 502-047	42331327	8RA 003 660-007	1 065 783	9EL 354 057-011	1 130 105	9EL 354 071-011
X 830 180 196 000	2VP 007 502-047	42340069	2JA 001 357-002	1 065 786	9EL 171 556-041	1 130 110	9EL 354 071-021
X 830 180 197	2VA 007 502-111	42460351	9EL 110 536-001	1 065 787	9EL 171 556-031	1 130 111	9EL 354 071-011
X 830 180 197	2VA 007 502-117	42487086	9EL 113 324-001	1 067 265	2NE 354 062-021	1 130 814	2ZR 354 063-011
X 830 180 198	2VP 007 502-121	42530460	9EL 146 491-001	1 067 267	9EL 354 059-021	1 134 215	1LE 010 199-031
X 830 180 198	2VP 007 502-127	42531998	9EL 115 830-001	1 067 268	9EL 354 059-011	1 134 219	1LE 010 199-041
X 830 180 200	2DA 008 136-007	445502	2KA 003 168-021	1 068 441	9EL 171 556-041	1 136 537	9EL 171 558-021
X 830 180 200	2SD 003 167-021	44902454	2KA 001 389-101	1 068 444	9EL 171 556-031	1 136 538	9EL 171 558-011
X 830 180 200 020	9GD 087 883-355	44906471	2BE 003 014-251	1 069 266	2ZR 354 063-011	1 137 928	9EL 354 060-021
X 830 180 201	2SE 003 167-031	44906471	2BE 003 014-257	1 069 982	9EL 354 061-021	1 137 929	9EL 354 060-011
X830180202	8KA 144 707-007	46429203	1LF 006 826-261	1 069 984	9EL 354 061-011	1 138 143	2ZR 354 063-011
X 830 180 205	2XS 008 479-001	46429204	1LF 006 826-251	1 070 140	1LE 010 199-041	1 138 144	2NE 354 062-021
X 830 180 205	2XS 008 479-007	46512541	2BA 270 016-041	1 070 142	1LE 010 199-031	1 140 063	1LG 354 024-141
X 830 180 206	2XS 008 479-011	46512542	2BA 270 016-031	1 070 679	1LE 010 199-041	1 140 073	1LG 354 024-131
X 830 180 206	2XS 008 479-017	4833768	2SA 001 259-751	1 070 681	1LE 010 199-031	1 140 076	9EL 171 558-021
X830180207	2DA 343 800-001	4833768	2SA 001 259-757	1 070 832	9EL 354 057-021	1 140 077	9EL 171 558-011
X830180207	2DA 343 800-007	4961371	2SD 001 680-281	1 070 835	9EL 171 556-041	1 142 871	1LF 010 197-041
X 830 180 208	8KA 146 751-007	4961372	2SE 001 680-291	1 070 837	9EL 354 057-011	1 142 875	1LF 010 197-031
X830180209	2DA 343 800-057	5154298	8JA 003 526-001	1 070 839	9EL 171 556-031	1 143 163	1LE 010 198-061
X 830 180 250	2ZR 003 236-051	51542980	8JA 003 526-001	1 071 974	1LE 010 199-041	1 143 168	1LE 010 198-051
X 830 180 250	2ZR 003 236-057	593628	2SD 001 693-011	1 071 976	1LE 010 199-031	1 143 437	9EL 354 061-021
X 830 180 250 000	2ZR 003 236-051	60657892	2DA 007 421-027	1 072 423	2VP 354 034-021	1 143 438	9EL 354 061-011
X 830 180 250 000	2ZR 003 236-057	638230	2PS 002 727-001	1 072 424	2VP 354 034-011	1 145 718	1LE 010 198-061
X830180307	2NE 344 610-007	71130013	2KA 001 389-101	1 074 084	9EL 354 061-021	1 151 625	1LE 010 198-051
X830180209	2DA 343 800-057	71130027	2AA 001 200-001	1 074 085	9EL 354 061-011	1 148 290	9EL 171 556-041
X 830 190 050	8RL 002 009-021	71130034	8HG 002 240-021	1 074 880	1LE 010 199-041	1 148 292	9EL 171 556-031
X 830 190 052 000	8RA 002 014-101	71130046	2BA 001 259-611	1 074 884	1LE 010 199-031	1 149 113	1NA 010 205-011
X 830 190 055	8RA 002 023-001	71130046	2BA 001 259-618	1 075 073	1LE 010 199-031	1 149 114	1NA 010 205-021
X 830 190 055 000	8RA 002 023-001	71130101	8HG 002 240-031	1 075 075	1LE 010 199-041	1 150 021	9EL 354 057-021
X 830 230 554 000	8JA 990 065-001	71300027	2AA 001 200-001	1 076 373	9EL 354 061-021	1 150 022	9EL 354 057-011
X 830 250 024 000	4RA 003 530-001	71403699	8XS 113 389-001	1 076 374	9EL 354 061-011	1 151 625	9EL 171 558-021
X 840 070 251	2JA 001 364-001	71701052	2AB 004 532-001	1 084 891	1LE 010 199-041	1 151 627	9EL 171 558-011
Y 252 702 0	2BA 003 022-021	71904420	2BE 003 014-251	1 084 892	1LE 010 199-031	1 152 092	1LE 010 199-041
Y 252 702 4	2SD 003 184-031	71904420	2BE 003 014-257	1 085 526	9EL 354 061-021	1 152 093	1LE 010 199-031
Y 252 702 4	2SD 003 184-037	79069588	2BA 002 652-111	1 085 655	9EL 171 556-041	1 152 386	1LE 010 198-051
Y 252 702 7	2SD 003 184-041	79069588	2BA 002 652-117	1 085 665	9EL 171 556-031	1 152 393	1LE 010 198-061
Y 252 702 7	2SD 003 184-047	79069589	2BA 002 652-121	1 088 971	1LE 010 199-041	1 152 468	1LE 010 198-061
Y 650 000 1	9EL 118 700-001	79069589	2BA 002 652-127	1 088 974	1LE 010 199-031	1 152 471	1LE 010 198-051
Y 650 000 2	9EL 118 701-001	8119043	2KA 004 525-001	1 091 952	9EL 171 556-041	1 198 222	1LF 010 197-041
		8168785	8JA 003 526-001	1 091 978	9EL 171 556-031	1 198 226	1LF 010 197-031
		81812945	9EL 135 266-001	1 092 586	9EL 354 061-021	1 202 217	2BA 010 232-011
		81813545	8RA 002 016-121	1 092 589	9EL 354 061-011	1 202 218	2BA 010 232-021
		81815335	9EL 043 137-001	1 095 311	9EL 354 057-021	1 202 349	1NA 010 205-011
		81817350	8JA 001 930-001	1 095 312	9EL 354 057-011	1 202 351	1NA 010 205-021
		81838694	8RA 002 023-001	1 096 628	1LE 010 199-031	1 202 717	1LF 010 197-041
		83926045	8RA 002 015-001	1 097 794	1LG 354 023-081	1 202 721	1LF 010 197-031
		83931521	8GH 002 089-133	1 097 797	1LG 354 023-041	1 203 538	1NA 010 205-011
		83952724	8GA 002 071-131	1 097 799	1LG 354 023-071	1 203 540	1NA 010 205-021
		83959697	1L3 005 649-017	1 097 803	1LG 354 023-031	1 204 323	1NA 010 205-021
		83961516	2BE 002 582-031	1 097 878	1LE 010 199-041	1 204 324	1NA 010 205-011
		83985986	8GD 002 078-121	1 098 043	9EL 354 057-021	1 204 733	1LE 010 198-101
		83989283	9EL 112 741-001	1 098 064	9EL 171 556-041	1 204 734	1LE 010 198-091
		83989315	9EL 112 743-001	1 098 086	9EL 354 057-011	1 205 193	1LG 354 024-081
		84037090	2SE 002 578-701	1 098 788	9EL 171 556-031	1 205 195	1LG 354 024-061
		84037090	2SE 002 578-707	1 102 373	2VP 354 037-021	1 205 197	1LG 354 024-071
		88700084	2BA 001 248-001	1 102 374	2VP 354 037-011	1 205 199	1LG 354 024-051
		88700087	2SB 003 018-031	1 103 150	1NL 007 594-041	1 205 546	2BA 010 232-021
		88900168	9EL 111 647-001	1 103 496	1NL 007 594-031	1 205 547	2BA 010 232-011
		88900169	9EL 107 368-001	1 104 276	9EL 354 059-021	1 205 701	2VP 354 037-021
		93191714	9EL 119 544-021	1 104 277	9EL 354 059-011	1 205 706	2VP 354 037-011
		93191715	9EL 119 544-001	1 106 724	2ZR 354 063-011	1 207 958	2ZR 354 063-011
		93191716	9EL 119 544-031	1 107 390	2NE 354 062-021	1 212 358	1LF 010 197-041
		93191717	9EL 120 201-001	1 108 923	9EL 964 480-011	1 212 362	1LF 010 197-031
		93191718	9EL 119 544-111	1 108 924	9EL 964 479-011	1 214 223	9EL 354 061-011
		9638230	2PS 002 727-001	1 113 574	2VP 354 037-021	1 214 226	9EL 354 061-021
		9651052	2PF 001 648-161	1 113 577	2VP 354 037-011	1 215 917	9EL 354 059-021
		99446124	2SE 001 685-221	1 114 893	1LG 354 023-081	1 216 868	1LE 010 198-061
		99446124	2SE 001 685-227	1 114 895	1LG 354 023-041	1 216 912	1LE 010 198-051
		99446125	2XS 950 071-031	1 114 897	1LG 354 023-071	1 218 226	1LE 010 198-101
		99446125	2SD 001 685-231	1 114 899	1LG 354 023-031	1 218 242	1LE 010 198-091
		99446126	2SD 001 685-232	1 114 970	9EL 171 558-021	1 219 836	9EL 354 059-011
		9946766	2XS 950 071-031	1 114 971	9EL 354 071-021	1 227 684	9EL 171 558-011
		9946767	2BA 007 042-041	1 114 972	9EL 171 558-011	1 227 685	9EL 171 558-021
		000 9947 274	2BA 007 042-031	1 114 973	9EL 354 071-011	1 232 640	1LG 354 024-141
		9947665	8GH 005 635-121	1 115 367	9EL 354 071-021	1 232 641	1LG 354 024-081
			6NM 007 282-661	1 115 368	9EL 354 071-011	1 232 642	1LG 354 024-061
				1 116 259	1LE 010 199-041	1 232 648	1LG 354 024-131
				1 116 267	1LE 010 199-031	1 232 649	1LG 354 024-051
				1 116 629	2VP 354 037-021	1 232 650	1LG 354 024-071
				1 116 630	2VP 354 037-011	1 233 324	9EL 171 556-031
				1 119 440	9EL 354 057-021	1 233 325	9EL 171 556-041
				1 119 442	9EL 354 057-011	1 255 214	9EL 171 558-061
				1 120 246	9EL 171 556-041	1 306 252	1NA 010 205-021
				1 120 248	9EL 171 556-031	1 306 253	1NA 010 205-011
				1 120 616	9EL 354 061-		

Manufacturer's no. / Hella no.

Cross-Reference



Ford	Hella	Ford	Hella	Ford	Hella	Ford	Hella
1 329 412	1LL 010 201-241	1 542 754	1LJ 009 696-731	2M51 13W030 FB	1LE 010 198-051	4 695 295	1LG 354 024-071
1 329 414	1LL 010 201-071	1 568 199	2SA 001 259-751	2M51 15201 AD	1NA 010 205-011	4 695 296	1LG 354 024-051
1 329 418	1LL 010 201-231	1 568 199	2SA 001 259-757	2M51 15201 AE	1NA 010 205-011	4 696 768	1LG 354 024-141
1 329 635	9EL 354 067-021	1 579 904	1LJ 247 045-341	2M51 15201 AF	1NA 010 205-011	4 696 770	1LG 354 024-081
1 329 637	9EL 354 067-011	1 579 911	1LL 247 045-381	2M51 15201 AG	1NA 010 205-011	4 696 772	1LG 354 024-061
1 331 600	9EL 354 071-021	1 580 706	1LJ 247 045-331	2M51 15201 AH	1NA 010 205-011	4 696 795	1LG 354 024-131
1 331 601	9EL 354 071-011	1 580 708	1LL 247 045-371	2M51 15K201 AD	1NA 010 205-021	4 696 799	1LG 354 024-071
1 333 744	9EL 354 065-021	1 582 913	2AA 001 200-151	2M51 15K201 AE	1NA 010 205-021	4 696 801	1LG 354 024-051
1 333 746	9EL 354 065-011	1 583 532	6ZE 001 759-051	2M51 15K201 AF	1NA 010 205-021	4C16 13008 HA	1LG 354 024-141
1 333 832	9EL 354 066-021	1 631 498	2VP 354 034-021	2M51 15K201 AG	1NA 010 205-021	4C16 13008 KA	1LG 354 024-081
1 333 834	9EL 354 066-011	1 631 499	2VP 354 034-011	2M51 15K201 AH	1NA 010 205-021	4C16 13008 MA	1LG 354 024-061
1 343 652	1LE 010 198-061	1 641 671	2VP 354 034-021	2M5V 13100 AA	1LE 010 198-161	4C16 13008 UA	1LG 354 024-141
1 343 656	1LE 010 198-051	1 641 672	2VP 354 034-011	2M5V 13100 AB	1LE 010 198-161	4C16 13008 VA	1LG 354 024-081
1 345 971	1LE 010 198-101	1 641 702	2VP 354 034-021	2M5V 13100 AC	1LE 010 198-161	4C16 13008 ZA	1LG 354 024-061
1 345 973	1LE 010 198-091	1 641 703	2VP 354 034-011	2M5V 13100 AD	1LE 010 198-161	4C16 13035 HA	1LG 354 024-131
1 347 460	1LE 270 600-201	1 657 855	3AF 003 399-041	2M5V 13101 AA	1LE 010 198-151	4C16 13035 KA	1LG 354 024-071
1 347 462	1LE 270 600-191	1 657 856	3AF 003 399-051	2M5V 13101 AB	1LE 010 198-151	4C16 13035 MA	1LG 354 024-051
1 353 952	1LG 354 024-141	1 657 858	6ZE 001 759-071	2M5V 13101 AC	1LE 010 198-151	4C16 13035 UA	1LG 354 024-131
1 353 953	1LG 354 024-081	1 660 382	2BA 003 022-021	2M5V 13101 AD	1LE 010 198-151	4C16 13035 VA	1LG 354 024-071
1 353 956	1LG 354 024-061	1 660 431	2AA 001 200-151	2M5V 13W029 FA	1LE 010 198-161	4C16 13035 ZA	1LG 354 024-051
1 353 992	1LG 354 024-131	1 813 545	8RA 002 016-121	2M5V 13W030 FA	1LE 010 198-151	4M51 13099 BA	1LL 010 201-041
1 353 993	1LG 354 024-071	1 815 335	9EL 043 137-001	2N1H 13W029 DF	1LD 246 044-241	4M51 13099 FA	1LL 010 201-121
1 353 994	1LG 354 024-051	1 838 694	8RA 002 023-001	2N1H 13W030 DF	1LD 246 044-231	4M51 13099 HA	1LL 010 201-201
1 360 558	1LD 246 044-241	1M51 13005 DA	1LE 010 199-041	2S6X 13W029 DA	1LF 010 197-041	4M51 13099 KA	1LL 010 201-081
1 360 560	1LD 246 044-231	1M51 13006 DA	1LE 010 199-031	2S6X 13W029 DB	1LF 010 197-041	4M51 13099 PA	1LL 010 201-161
1 370 132	2ZR 354 063-011	1M51 13A602 AA	9EL 354 061-021	2S6X 13W029 DC	1LF 010 197-041	4M51 13099 SA	1LL 010 201-241
1 370 143	2NE 354 062-021	1M51 13A602 AB	9EL 354 061-021	2S6X 13W029 DD	1LF 010 197-041	4M51 13101 BA	1LL 010 201-031
1 371 849	9EL 171 558-021	1M51 13A602 BA	9EL 354 057-021	2S6X 13W029 DE	1LF 010 197-041	4M51 13101 FA	1LL 010 201-111
1 371 852	9EL 171 558-061	1M51 13A602 CA	2NE 354 062-021	2S6X 13W030 DA	1LF 010 197-031	4M51 13101 HA	1LL 010 201-191
1 371 855	9EL 171 558-041	1M51 13A602 CB	2NE 354 062-021	2S6X 13W030 DB	1LF 010 197-031	4M51 13101 KA	1LL 010 201-071
1 371 857	9EL 171 558-031	1M51 13A602 CC	2NE 354 062-021	2S6X 13W030 DC	1LF 010 197-031	4M51 13101 PA	1LL 010 201-151
1 371 859	9EL 171 558-051	1M51 13A602 FA	9EL 171 556-041	2S6X 13W030 DD	1LF 010 197-031	4M51 13101 SA	1LL 010 201-231
1 371 861	9EL 171 558-011	1M51 13A602 FB	9EL 171 556-041	2S6X 13W030 DE	1LF 010 197-031	4M51 13A602 AA	9EL 354 067-021
1 380 503	9EL 354 055-021	1M51 13A603 AA	9EL 354 061-011	2T1A13K767AC	1KO 008 191-021	4M51 13A602 AB	9EL 354 067-021
1 380 505	9EL 354 055-011	1M51 13A603 AB	9EL 354 061-011	2T1A13K767AC	1KO 008 191-027	4M51 13A602 FA	9EL 354 065-021
1 383 603	9EL 354 070-021	1M51 13A603 BA	9EL 354 057-011	30 884 017	2RL 008 064-101	4M51 13A603 AA	9EL 354 067-011
1 383 636	9EL 354 054-021	1M51 13A603 FA	9EL 171 556-031	32 009 011	8GH 002 090-251	4M51 13A603 AB	9EL 354 067-011
1 383 638	9EL 354 070-011	1M51 13A603 FB	9EL 171 556-031	32 009 011	8GH 002 090-253	4M51 13A603 FA	9EL 354 065-011
1 383 641	9EL 354 054-011	1M51 15512 AA	2ZR 354 063-011	32 010 159	8GA 002 073-121	5 026 651	2KA 004 525-001
1 386 531	2NE 354 062-021	1M51 15512 AB	2ZR 354 063-011	32 230 100	2XW 003 146-001	5 047 172	2KA 001 386-231
1 406 676	2NR 010 229-021	1M51 15512 AC	2ZR 354 063-011	3 227 655 0	2SD 001 305-021	5C46 13N429AA	1G4 003 470-031
1 406 677	2NR 010 229-011	1M50 13100 AA	1LE 010 198-101	3 227 655 0	2SD 003 184-041	5C46 13N429 BA	1G4 003 470-031
1 406 679	2SD 010 230-021	1M50 13100 AB	1LE 010 198-101	3 227 655 0	2SD 003 184-047	5C46 13N429 AA	8GH 002 090-251
1 406 680	2SD 010 230-011	1M50 13100 AC	1LE 010 198-101	32 276 583	2SB 003 018-031	5C46 13N429 BA	8GH 002 090-253
1 416 560	2ZR 354 063-011	1M50 13101 AA	1LE 010 198-091	32 276 630	8RA 002 015-031	5M51 13A602 AA	9EL 354 066-021
1 419 079	2NE 354 068-021	1M50 13101 AB	1LE 010 198-091	32 276 652	1S3 001 117-041	5M51 13A602 BA	2NE 354 068-021
1 419 084	2ZR 354 069-011	1M50 13101 AC	1LE 010 198-091	32 280 228	1G5 003 241-021	5M51 13A603 AA	9EL 354 066-011
1 420 450	9EL 354 067-021	1MVO 13368 BA	9EL 354 060-021	3 959 697	1L3 005 649-017	5M51 15512 AA	2ZR 354 069-011
1 420 451	9EL 354 067-011	1MVO 13368 BB	9EL 354 060-021	3 961 516	2BE 002 582-031	5NN13N302A	9EL 043 137-001
1 420 467	9EL 354 065-021	1MVO 13369 BA	9EL 354 060-011	3 989 283	9EL 112 743-001	5NN13N365A	9EL 088 538-001
1 420 470	9EL 354 065-011	1MVO 13369 BB	9EL 354 060-011	3 989 315	9EL 112 741-001	5NN13N366A	9EL 088 525-001
1 432 269	9EL 354 055-021	1S71 13404 AF	9EL 171 558-021	3 991 017	9EL 112 744-001	5NN13N370A	2BE 001 259-061
1 432 274	9EL 354 055-011	1S71 13404 AH	9EL 171 558-021	3C1115K201AA	1NE 007 517-051	6 044 355	2PF 001 648-171
1 435 880	9EL 171 968-021	1S71 13404 AL	9EL 171 558-021	3C1115K201BA	1NE 007 517-061	6 048 873	9GH 116 966-011
1 435 881	9EL 171 968-011	1S71 13404 AM	9EL 171 558-021	3C4613005BA	1KO 008 191-021	6 083 293	8JA 003 526-001
1 437 625	9EL 354 054-021	1S71 13404 CD	9EL 354 071-021	3C4613005BA	1KO 008 191-027	6 099 827	2KA 001 389-101
1 437 626	9EL 354 054-011	1S71 13404 CE	9EL 354 071-021	3C4613368AA	2BA 008 221-001	6 117 712	9HD 121 297-001
1 438 497	1LJ 009 250-781	1S71 13404 CF	9EL 354 071-021	3C4613368AA	2BA 008 221-007	6 134 866	2PF 001 648-171
1 438 504	1LJ 009 250-771	1S71 13404 CG	9EL 354 071-021	3C4613A387AA	9GT 137 236-007	6 158 263	2VP 354 034-021
1 464 086	9EL 171 558-041	1S71 13404 CH	9EL 354 071-021	3C4613B390AA	2BA 008 221-001	6 158 264	2VP 354 034-011
1 464 087	9EL 171 558-031	1S71 13404 CJ	9EL 354 071-021	3C4613B390AA	2BA 008 221-007	6 161 978	2VP 354 034-021
1 480 980	1LL 010 201-041	1S71 13405 AF	9EL 171 558-011	3C4613D138AA	6NM 007 231-037	6 161 979	2VP 354 034-011
1 480 982	1LL 010 201-121	1S71 13405 AG	9EL 171 558-011	3C4613D140AA	8GH 007 157-241	6 188 647	2VP 354 034-021
1 480 984	1LL 010 201-201	1S71 13405 AL	9EL 171 558-011	3C4613D141AA	8GP 002 067-241	6 188 648	2VP 354 034-011
1 480 986	1LL 010 201-081	1S71 13405 AM	9EL 171 558-011	3C46 13D144 AA	8JD 156 150-807	6 197 982	9EL 354 072-021
1 480 988	1LL 010 201-161	1S71 13405 CD	9EL 354 071-011	3C4613D146BA	1KO 008 191-021	6 197 983	9EL 354 072-011
1 480 991	1LL 010 201-031	1S71 13405 CE	9EL 354 071-011	3C4613D146BA	1KO 008 191-027	6 200 194	2VP 354 034-021
1 480 993	1LL 010 201-111	1S71 13405 CF	9EL 354 071-011	3C4613K046AA	9GH 152 654-007	6 200 195	2VP 354 034-011
1 480 995	1LL 010 201-191	1S71 13405 CG	9EL 354 071-011	3C4613N361AA	8GA 006 841-241	6 695 705	2VP 354 034-021
1 480 997	1LL 010 201-071	1S71 13405 CH	9EL 354 071-011	3C4615B212AA	9GH 158 051-007	6 695 706	2VP 354 034-011
1 480 999	1LL 010 201-151	1S71 13405 CJ	9EL 354 071-011	3C4615B224AA	1NO 008 582-011	6 777 877	2BA 919 370-051
1 481 001	1LL 010 201-231	1S71 13A602 AA	9EL 354 071-021	3C4615B224AA	1NO 008 582-017	6 777 878	2BA 919 370-061
1 481 005	1NO 354 016-021	1S71 13A602 CB	9EL 354 071-021	3C4615K201AA	1NO 008 582-011	6 955 366	9EL 354 072-021
1 481 007	1NO 354 016-011	1S71 13A602 CC	9EL 354 071-021	3C4615K201AA	1NO 008 582-017	6 955 367	9EL 354 072-011
1 483 061	1LL 010 201-241	1S71 13A602 CD	9EL 354 071-021	3M51 13100 BA	1LE 270 600-201	6 955 367	9EL 171 968-011
1 486 766	9EL 176 576-021	1S71 13A602 CE	9EL 354 071-021	3M51 13101 BA	1LE 270 600-191	6C1113450AA	9EL 171 968-021
1 486 771	9EL 176 576-011	1S71 13A602 EA	9EL 171 558-021	3M51 15K201 AA	1NO 354 016-011	6C1113451AA	6ED 004 778-011
1 486 778	9EL 176 577-021	1S71 13A602 EB	9EL 171 558-021	3M51 15K202 AA	1NO 354 016-021	6M21 12K072AA	5DV 009 000-001
1 486 783	9EL 176 577-011	1S71 13A602 EC	9EL 171 558-021	3S5115B504AA	2ZR 008 221-157	6N11 13A602 AB	9EL 354 070-021
1 490 612	9EL 354 678-041	1S71 13A602 ED	9EL 171 558-021	3S71 13A602 EA	9EL 171 558-061	6N11 13A603 AB	9EL 354 070-011
1 490 616							



Manufacturer's no. / Hella no.

Cross-Reference

Ford	Hella	Ford	Hella	Ford	Hella	Fritzmeier	Hella
73 882 233	2SA 003 014-051	96BG15205AB	1NL 007 594-031	XS4X 13A603 HC	9EL 171 556-031	220 564	2BE 003 014-251
7 400 511	1NE 007 517-061	96BG15205AC	1NL 007 594-031	XS4X 13A603 HD	9EL 171 556-031	220 564	2BE 003 014-257
75VB15442AA	2SA 001 259-751	96BG15205AD	1NL 007 594-031	XS4X 13K384 AD	9EL 354 059-021	220816	2BA 002 652-101
75VB15442AA	2SA 001 259-757	96BG15K205AB	1NL 007 594-041	XS4X 13K384 EA	9EL 354 059-021	221 379	2BA 002 652-102
7M5113W029BB	1LJ 009 587-641	96BG15K205AC	1NL 007 594-041	XS4X 13K384 AF	9EL 354 059-021	221 809	4AZ 003 787-027
7M5113W030BB	1LJ 009 587-631	96BG15K205AD	1NL 007 594-041	XS4X 13K384 AG	9EL 354 059-021	222 559	2JA 001 357-002
7S7113005BH	1LL 010 541-121	97CT15K235BA	4RA 003 530-051	4RAX 13K385 AD	9EL 354 059-011	222 643	1TA 001 357-001
7S7113006BH	1LL 010 541-111	97VX 13368 AA	9EL 354 072-021	XS4X 13K385 AE	9EL 354 059-011	222624	2SD 003 184-031
7S71-13007-BF	1ZL 010 541-081	97VX 13369 AA	9EL 354 072-011	4RAX 13K385 AF	9EL 354 059-011	222643	2SD 003 184-037
7S71-13008-BF	1ZL 010 541-071	98CT13K354AA	2BM 006 692-011	XS4X 13K385 AG	9EL 354 059-011	222644	2SD 003 184-041
7S7113100BF	1LF 010 541-041	98CT13K354AB	2BM 006 692-017	XS4X 15512 AC	2ZR 354 063-011	222646	2SD 003 184-047
7S7113101BF	1LF 010 541-031	98CT13K354BA	2BM 006 692-021	YC15 13404 AD	2ZR 354 063-011	222646	8GP 002 067-241
7S7113404NH	9EL 176 575-021	98CT13K354BA	2BM 006 692-027	YC15 13404 AE	2VP 354 037-021	222 775	2ZR 003 014-091
7S7113404PF	9EL 176 577-021	9HB15K201BA	2NE 001 423-011	YC15 13404 AF	2VP 354 037-021	222 778	2VP 354 037-021
7S7113404RH	9EL 176 574-021	9SX 863.323-001	8KB 863 323-001	YC15 13404 AG	2VP 354 037-021	224 170	1K0 008 191-001
7S7113405NH	9EL 176 575-011	A91A X13550AA	2KA 004 525-001	YC15 13405 AD	2VP 354 037-011	224 170	1K0 008 191-007
7S7113405PF	9EL 176 577-011	AC46 13776 AA	2JA 006 447-087	YC15 13405 AE	2VP 354 037-011	224 172	9GH 152 654-007
7S7113405RH	9EL 176 574-011	D86VB 13404 AF	2VP 354 034-021	YC15 13405 AF	2VP 354 037-011	224 854	8HG 006 294-031
7S7113A602NG	9EL 176 576-021	D86VB 13405 AF	2VP 354 034-011	YC15 13405 AG	2VP 354 037-011	224 878	9GH 993 984-001
7S7113A603NG	9EL 176 576-011	D8NN13A565BA	8RA 002 015-001	YC15 13405 AG	2VP 354 037-011	224902	2SD 343 910-017
0 800 129	2KA 001 386-241	E3NN13707AA	2JA 003 231-001	YC1513B376BA	2BA 010 232-021	225 373	2JA 009 037-027
81 813 545	8RA 002 016-121	V1C4415592AA	1G4 003 470-031	YC1513B376BB	2BA 010 232-021	225 375	2SD 343 910-027
81 815 335	9EL 043 137-001	V1C4415592AA	1G4 003 470-051	YC1513B377BA	2BA 010 232-011	226 107	1GD 996 176-131
81 817 350	8JA 001 930-001	V1C4415K490AA	2TJ 001 633-211	YC1513B377BB	2BA 010 232-011	226 108	1GD 996 176-141
81DB13A450BA	8JB 001 943-001	V1C4415T637AA	8HG 006 294-011	YC1515201AA	1NE 007 517-051	226 109	1GD 996 176-041
83 959 697	1L3 005 649-017	V1C4613465AA	8GH 002 090-251	YC1515201AD	1NE 007 517-051	226 112	8JB 850 434-011
83 961 516	2BE 002 582-031	V1C4613465AA	8GH 002 090-253	YC1515K201AA	1NE 007 517-061	226 113	9BH 096 532-001
83 989 283	9EL 112 743-001	V76HB15442BB	2PF 003 057-041	YC1515K201AD	1NE 007 517-061	293 3967	2JA 001 364-001
83 989 315	9EL 112 741-001	V78GG 15A587AA	6ZE 001 759-051	YC15201AD	1NE 007 517-051	618 979	8GM 002 092-121
83 989 809	2XS 005 020-001	V82VG 15A587AA	6ZE 001 759-071	YC1X 13008 HF	1LG 354 024-141	620 269	2JA 001 330-031
83 989 809	2XS 005 020-002	V84VG 15585AA	3AF 003 399-041	YC1X 13008 KA	1LG 354 024-081	631 632	2JA 002 232-011
83 989 809	2XS 005 020-003	V84VG 15585BA	3AF 003 399-051	YC1X 13008 MA	1LG 354 024-061	751 759	2PF 961 167-021
83 991 017	9EL 112 744-001	V87BG 13774AA	2JA 001 357-002	YC1X 13008 UA	1LG 354 024-141	853 45	9BG 993 345-001
861 13W029 BD	1LJ 247 045-341	V93GG 18213AA	8JB 004 777-001	YC1X 13008 VB	1LG 354 024-141	ACFE02109060	1GD 996 176-131
861 13W029 BF	1LJ 247 045-341	V93GG 18213AA	8JB 004 777-002	YC1X 13008 VA	1LG 354 024-081	EC1993138	1GL 008 090-211
86VB 13404 AD1J	2VP 354 034-021	V95CT13380AA	8RA 003 326-011	YC1X 13008 VB	1LG 354 024-081	EC1993138	1GL 008 090-217
86VB 13404 AE	2VP 354 034-021	V95CT13380AA	8RA 003 326-017	YC1X 13008 ZB	1LG 354 024-061	EC2888632	4DM 009 492-001
86VB 13404 AF	2VP 354 034-021	V95CT13464AA	2SK 003 567-321	YC1X 13008 ZB	1LG 354 024-061	EC6C9121	2JA 001 357-002
86VB 13404 AG	2VP 354 034-021	V95CT13465AA	2SK 003 567-331	YC1X 13035 HF	1LG 354 024-131	HA4 220512	1GA 005 060-001
86VB 13404 AH	2VP 354 034-021	V95CT13K309AA	2BM 009 320-807	YC1X 13035 KA	1LG 354 024-071	HA4 240149	1GB 006 213-101
86VB 13404 AD1J	2VP 354 034-011	V9713K464AA	2SA 001 259-751	YC1X 13035 MA	1LG 354 024-051	HA4 240149	1GB 006 213-107
86VB 13405 AE	2VP 354 034-011	V9713K464AA	2SA 001 259-757	YC1X 13035 UA	1LG 354 024-131		
86VB 13405 AF	2VP 354 034-011	V97CT13K464AA	2SA 001 259-751	YC1X 13035 VA	1LG 354 024-131		
86VB 13405 AG	2VP 354 034-011	V97CT13K464AA	2SA 001 259-757	YC1X 13035 VB	1LG 354 024-071		
86VB 13405 AH	2VP 354 034-011	V98BG13774AA	2JA 001 364-001	YC1X 13035 ZB	1LG 354 024-071		
8 838 694	8RA 002 023-001	XS41 13005 GB	1LE 010 199-041	YC1X 13035 ZB	1LG 354 024-051		
8A61 13W029 DC	1LL 247 045-381	XS41 13005 GD	1LE 010 199-041	YC1X 13450 AD	2VP 354 037-021		
8A61 13W029 DE	1LL 247 045-381	XS41 13005 GE	1LE 010 199-041	YC1X 13451 AD	2VP 354 037-011		
8A61 13W030 BD	1LJ 247 045-331	XS41 13005 GF	1LE 010 199-041	YM21-13404-CH	9EL 964 484-011		
8A61 13W030 BF	1LJ 247 045-331	XS41 13005 GG	1LE 010 199-041	YM21-13405-CH	9EL 964 483-011		
8A61 13W030 BC	1LL 247 045-371	XS41 13005 GH	1LE 010 199-041	YM21-13A602-AB	9EL 964 480-011		
8A61 13W030 DE	1LL 247 045-371	XS41 13005 GL	1LE 010 199-041	YM21-13A603-AB	9EL 964 479-011		
8M5113404AB	9EL 354 679-021	XS41 13006 GB	1LE 010 199-031	YS4X 13A602 AB	2NE 354 062-021		
8M5113404DC	9EL 354 678-041	XS41 13006 GC	1LE 010 199-031	YS4X 13A602 AC	2NE 354 062-021		
8M5113404FB	9EL 354 678-081	XS41 13006 GD	1LE 010 199-031	YS4X 15512 AC	2ZR 354 063-011		
8M5113404JC	9EL 354 679-021	XS41 13006 GE	1LE 010 199-031	YS4X 15512 AD	2ZR 354 063-011		
8M5113404MA	9EL 354 678-041	XS41 13006 GF	1LE 010 199-031	YS4X 15512 AE	2ZR 354 063-011		
8M5113404MB	9EL 354 678-041	XS41 13006 GG	1LE 010 199-031				
8M5113404MC	9EL 354 678-041	XS41 13006 GH	1LE 010 199-031				
8M5113404PA	9EL 354 678-081	XS41 13006 GL	1LE 010 199-031				
8M5113404PB	9EL 354 678-081	XS41 13A602 AB	9EL 354 061-021				
8M5113405AB	9EL 354 678-081	XS41 13A602 AC	9EL 354 061-021				
8M5113405DC	9EL 354 678-031	XS41 13A602 AD	9EL 354 061-021				
8M5113405FB	9EL 354 678-071	XS41 13A602 AE	9EL 354 061-021				
8M5113405JC	9EL 354 679-011	XS41 13A602 AF	9EL 354 061-021				
8M5113405MA	9EL 354 678-031	XS41 13A602 BB	9EL 354 057-021				
8M5113405MB	9EL 354 678-031	XS41 13A602 BC	9EL 354 057-021				
8M5113405MC	9EL 354 678-031	XS41 13A602 BC	9EL 354 057-021				
8M5113405PA	9EL 354 678-071	XS41 13A602 FA	9EL 171 556-041				
8M5113405PB	9EL 354 678-071	XS41 13A602 FC	9EL 171 556-041				
8V4113W029BC	1LJ 009 696-741	XS41 13A602 FE	9EL 171 556-031				
8V4113W030BC	1LJ 009 696-731	XS41 13A603 AB	9EL 354 061-011				
90VB 13404 AA	2VP 354 034-021	XS41 13A603 AC	9EL 354 061-011				
90VB 13404 AB	2VP 354 034-021	XS41 13A603 AD	9EL 354 061-011				
90VB 13405 AA	2VP 354 034-011	XS41 13A603 AE	9EL 354 061-011				
90VB 13405 AB	2VP 354 034-011	XS41 13A603 BB	9EL 354 057-011				
92VB 13368 AA	9EL 354 072-021	XS41 13A603 BC	9EL 354 057-011				
92VB 13368 AB	9EL 354 072-021	XS41 13A603 BA	9EL 171 556-031				
92VB 13369 AA	9EL 354 072-011	XS41 13A603 BC	9EL 171 556-031				
92VB 13369 AB	9EL 354 072-011	XS41 13A603 CA	9EL 171 556-031				
93 191 716	9EL 119 544-031	XS4V18213AA	8JB 004 777-001				
95AG 15201AA	1ND 005 700-001	XS4V18213AA	8JB 004 777-002				
95VG 13005 SBA	1LG 354 023-081	XS4X 13005 GA	1LE 010 199-041				
95VG 13005 SBB	1LG 354 023-081	XS4X 13005 GB	1LE 010 199-041				
95VG 13005 SBC	1LG 354 023-081	XS4X 13005 GC	1LE 010 199-041				
95VG 13005 SDA	1LG 354 023-041	XS4X 13005 GD	1LE 010 199-041				
95VG 13005 SDB	1LG 354 023-041	XS4X 13006 GA	1LE 010 199-031				
95VG 13005 SDC	1LG 354 023-041	XS4X 13006 GB	1LE 010 199-031				
95VG 13006 SBA	1LG 354 023-071	XS4X 13006 GC	1LE 010 199-031				
95VG 13006 SBB	1LG 354 023-071	XS4X 13006 GD	1LE 010 199-031				
95VG 13006 SBC	1LG 354 023-071	XS4X 13A602 AC	2NE 354 062-021				
95VG 13006 SDA	1LG 354 023-031	XS4X 13A602 AD	2NE 354 062-021				
95VG 13006 SDB	1LG 354 023-031	XS4X 13A602 BB	9EL 354 057-021				
95VG 13006 SDC	1LG 354 023-031	XS4X 13A602 BC	9EL 354 057-021				
95VG 13368 AA	9EL 354 072-021	XS4X 13A602 CA	9EL 354 057-021				
95VG 13368 AB	9EL 354 072-021	XS4X 13A602 CB	9EL 354 057-021				
95VG 13368 AC	9EL 354 072-021	XS4X 13A602 CD	9EL 354 061-021				
95VG 13369 AA	9EL 354 072-011	XS4X 13A602 FE	9EL 171 556-041				
95VG 13369 AB	9EL 354 072-011	XS4X 13A602 FF	9EL 171 556-041				
95VG 13369 BA	9EL 354 072-011	XS4X 13A602 HA	9EL 171 556-041				
95VG 13404 AA	2VP 354 034-021	XS4X 13A602 HC	9EL 171 556-041				
95VG 13404 AB	2VP 354 034-021	XS4X 13A602 HD	9EL 171 556-041				
95VG 13404 AC	2VP 354 034-021	XS4X 13A603 BB	9EL 354 057-011				
95VG 13404 AD	2VP 354 034-021	XS4X 13A603 BC	9EL 354 057-011				
95VG 13404 AE	2VP 354 034-021	XS4X 13A603 BD	9EL 354 057-011				
95VG 13405 AA	2VP 354 034-011	XS4X 13A603 CA	9EL 354 061-011				
95VG 13405 AB	2VP 354 034-011	XS4X 13A603 CD	9EL 354 061-011				
95VG 13405 AC	2VP 354 034-011	XS4X 13A603 CE	9EL 354 061-011				
95VG 13405 AD	2VP 354 034-011	XS4X 13A603 FE	9EL 171 556-031				
		XS4X 13A603 FF	9EL 171 556-031				

Manufacturer's no. / Hella no.

Cross-Reference



Hako	Hella	Hanomag-Henschel	Hella	Hanomag-Henschel	Hella	Hanomag-Henschel	Hella
90154444	2SY 003 014-121	159 9334 0	2AA 001 200-131	42Y0 6H3 050	8RA 004 412-001	X 880 001 085 063	2KA 001 386-291
90-17773-4	2BA 001 277-011	1730 232 M1	8GA 002 072-121	42Y0 6H3 190	VVP 006 040-111	X 880 001 085 890	2BA 001 277-011
90-17774-2	2BA 001 277-021	1732 172 M1	8GA 002 073-121	42Y0 6H3 190	VVP 006 040-117	X 880 001 085 891	2BA 001 277-021
90178062	2SD 003 184-041	000 1821 351	8JA 001 909-011	42Y0 6H3 200	VVP 006 040-121	X 885 957 660 390	2JA 003 232-011
90-17808-6	2SD 003 184-047	20E-06-H9150	3AG 003 399-101	42Y0 6H3 200	VVP 006 040-127	Y252 702 0	2BA 003 022-021
90-17808-8	2SD 003 184-031	20G 0631 160	1LA 996 074-197	42Y0 6H3 220	9GD 102 484-001	Y252 702 4	2SD 003 184-031
90-17808-8	2SD 003 184-037	20G 0631 260	1LA 996 074-207	42Y0 6H3 220	9EL 136 825-001	Y252 702 7	2SD 003 184-047
90-17809-6	2SD 003 184-041	20G46K1681	8RA 004 412-001	42Y06HOP02	9EL 136 825-011	Y650 000 1	9EL 118 700-001
90-17809-6	2SD 003 184-047	20G 47K1 690	8RA 002 014-031	4600 186 M1	H8G 002 240-021	Y650 000 2	9EL 118 701-001
90191594	2SD 003 182-051	20G 47K1 690	8RA 002 014-032	4600 375 M1	8RA 002 015-031		
90191594	2SD 003 182-057	20K4631820	8RA 002 014-032	4603 153 M1	8RA 003 326-011		
90-19160-2	2SE 003 182-021	21F0 614 410	2PF 001 650-001	4603 153 M1	8RA 003 326-017		
90-19160-2	2SE 003 182-027	289 5819 M91	1G5 003 241-021	4603 561 M1	8XS 113 389-001		
90-19161-0	2SD 003 182-061	289 7205 M91	2AB 001 208-001	4603 644 091	1LB 003 177-081		
90-19161-0	2SD 003 182-067	290 4951 M91	2JA 001 360-001	4603 644 M91	1LB 003 177-081		
90-19162-8	2SE 003 182-011	2904 951 M91	2JA 001 360-001	4901 618 M1	2BA 002 652-101		
90-19162-8	2SE 003 182-017	292 4326 M91	2AA 001 200-011	4901 618 M1	2BA 002 652-107		
90-19447-3	1G4 003 470-031	292 4326 M91	2AA 001 200-012	4917 453 M1	9EL 134 659-001		
90-19456-4	8GH 002 090-251	292 4328 M91	2AA 001 200-031	4917 455 M1	9EL 134 659-001		
90-19456-4	8GH 002 090-253	292 4332 M91	2AA 001 200-021	50102640	2JA 003 232-001		
90197500	2TJ 001 633-211	292 4332 M91	2AA 001 200-023	50134398	8GP 002 095-241		
90-22708-3	2BE 003 014-251	292 4342 M91	2ZR 001 240-351	503 6014	1GA 006 991-041		
90-22708-3	2BE 003 014-257	292 8260 M1	1S3 001 117-041	516 2459 8	8GM 002 091-251		
90-23160-6	8RA 004 412-021	292 8454 M1	2BA 001 248-001	56234373	1GA 006 991-041		
90-24388-2	2SE 002 578-701	293 2480 M1	9FF 090 500-001	57622340	8GM 002 091-251		
90-24388-2	2SE 002 578-707	293 3967 M91	2JA 001 364-001	058 2504 0	1S5 003 178-431		
90-24826-1	2BA 002 652-111	2933 967 M91	2JA 001 364-001	05838040	8GD 002 084-251		
90-24826-1	2BA 002 652-117	293 7744 M91	2KA 001 386-231	751 8700 07	2JA 003 232-011		
90-24827-9	2BA 002 652-107	294 2064 M1	9ES 012 060-011	76629173	2AA 001 200-151		
90-24827-9	2BA 002 652-107	294 2095 M1	9GD 023 639-001	76629173	8GH 002 089-251		
90-24827-9	2BA 002 652-121	294 2097 M1	9DR 090 206-001	769 6167 3	8GH 002 089-253		
90-24827-9	2BA 002 652-127	294 2098 M1	9KS 075 139-001	76961873	2JA 004 192-001		
90-29104-8	2XS 950 071-031	2942 098 M1	9KS 075 139-001	76961973	8GS 007 949-101		
90-31507-8	8RA 002 014-031	2949 833 M91	2BA 002 324-011	77004473	5DV 990 264-011		
90-31507-8	8RA 002 014-032	2949 834 M91	2BA 002 324-021	79334373	1GA 998 525-011		
90-31520-1	8RA 002 014-051	294 9835 M91	8JA 001 909-011	794 3817 3	1GA 998 525-011		
90-31520-1	8RA 002 014-052	2949 835 M91	8JA 001 909-011	89649740	8GP 002 067-241		
90-32191-0	2XS 005 020-011	295 1380 M91	2PF 001 634-101	89674540	2RL 006 846-011		
90-32191-0	2XS 005 020-017	2951 380 M91	2PF 001 634-101	89674540	1GA 998 532-011		
90321928	1GA 005 060-001	2954 497 M91	2BA 002 324-001	92F 001 016 65	8GP 002 095-121		
90-33707-2	8JA 001 909-001	296 1720 M1	9GD 024 163-001	B 969 071 237 101	8RA 002 016-121		
90-34013-1	8GJ 002 525-131	296 1721 M1	9KS 075 307-001	B 969 071 237 102	2BE 003 185-031		
90-34014-6	2SD 002 582-011	296 2889 M1	9DR 060 567-001	B 969 071 238 401	2ZR 003 030-171		
90-34014-6	2SD 002 582-017	299 8822 M1	9ES 015 675-001	B 969 071 282 002	1X0 001 515-021		
90-34014-7	2SD 002 582-021	2999 797 M1	2XW 003 146-001	B 969 071 282 008	2SE 001 679-051		
90-34014-7	2SD 002 582-027	20G0 6K1 120	2BA 003 014-111	B 969 071 282 008	2SD 003 184-031		
90-34015-3	2KA 004 525-001	306 2196 M8	9EL 087 769-001	B 969 071 282 009	2SD 003 184-037		
90-34015-4	2JA 001 330-001	306 2228 M8	2BE 001 278-011	B 969 071 282 009	2SD 003 184-041		
90-34015-4	2JA 001 330-007	306 2229 M8	2BE 001 278-012	B 969 071 282 011	2SD 003 184-047		
90-34017-1	8JA 001 909-001	306 5113 M8	2SB 003 018-031	B 969 071 282 011	2AA 001 200-131		
90-34058-1	8HG 006 294-031	307 5726 M91	2SA 001 634-121	B 969 171 324 212	8RA 003 503-001		
90-34334-4	2BM 004 965-801	3081 528 M1	8RA 002 016-121	B 969 171 346 205	2SD 001 305-021		
90-34396-3	2RL 006 846-001	3082 018 M1	9EL 146 491-001	B 969 171 346 206	8HG 854 516-001		
90-34397-1	8HG 006 294-051	308 3483 M91	2AA 001 200-001	B 969 271 409 210	6ZE 001 759-071		
90-34526-5	2BA 002 324-011	308 6298 M91	2KA 003 389-061	B 969 271 409 210	2SD 002 776-231		
90-34526-5	2BA 002 324-011	308 6298 M91	2KA 003 389-062	B 969 271 409 211	2SD 002 776-237		
90-34530-7	9FF 126 444-001	308 6298 M91	2KA 003 389-068	B 969 271 409 211	2SD 002 776-241		
90-34602-8	2KA 006 896-001	309 3000 M91	2BE 001 259-061	B 969 271 456 001	2SD 002 776-247		
90-34602-8	2KA 006 896-007	3093 002 M1	8GM 02 094-241	B 969 271 456 004	1GA 005 060-041		
90-35055-9	2ZR 003 315-041	3101 698 M1	1G5 120 510-001	X 842 070 990 001	8RA 003 503-001		
90-37266-5	1LB 006 213-047	310 1699 M1	6ED 708 919-001	X 842 070 990 002	2SD 001 305-021		
90-37956-1	4AZ 003 787-021	3228 01M 1	8GM 002 092-121	X 842 070 990 002	2SE 001 685-201		
90-37970-2	8HG 003 799-001	32309340	8RA 003 680-007	X 842 070 990 013	2SD 001 685-218		
90-37973-6	2RL 006 846-011	32483940	1G4 003 470-031	X 842 070 990 017	2TJ 001 633-211		
90-39206-9	2NE 003 315-011	32484040	8GH 002 090-251	X 860 001 085 890	2SA 001 634-121		
90-39243-2	2KA 001 389-101	395 9358 13	8GH 002 090-253	X 860 001 085 891	2BA 001 277-011		
90-39604-5	2ZR 006 609-081	4003 757 M91	2JA 001 360-001	X 860 046 098 000	2BA 001 277-021		
90-39604-5	2ZR 006 609-087	4003 757 M91	2SA 001 259-751	X 860 046 235 000	2KA 001 389-101		
90-41501-9	2BA 008 221-001	4061 82M 1	2SA 001 259-757	X 860 395 935 814	2PF 001 648-171		
90-41501-9	2BA 008 221-007	4062 18M 1	8JA 001 914-011	X 860 395 935 815	2JA 003 232-011		
90417932	1PT 008 362-801	4162Z 811 240	8GP 002 067-121	X 860 400 050 250	2JA 001 335-011		
90-43445-7	1GL 008 090-211	4180 6K1 910	8HG 002 240-021	X 860 400 050 250	2SD 001 685-211		
90445602	8RA 004 412-001	4180 6K2 250	8RA 002 016-111	X 860 400 050 480	2SD 001 685-218		
90 49874 2	2BA 009 001-071	4189 57H 110	9EL 113 324-001	X 860 400 050 550	8HG 002 365-001		
90 49874 2	2BA 009 001-077	4201 273 M1	2RL 008 062-111	X 860 400 050 550	2JA 001 330-001		
90 49875 9	2SB 009 001-061	4210 0H1 730	8JA 001 909-001	X 860 400 050 550	2JA 001 330-007		
90 49875 9	2SB 009 001-067	42106H2780	8RA 002 014-101	X 860 533 935 209	2BA 001 248-001		
90 51448 0	2PF 003 563-177	4210 6H3 080	2XS 005 020-067	X 860 535 935 719	2BA 002 324-011		
90 51988 5	2SB 009 001-157	42106H3160	1GD 003 590-701	X 860 540 186 047	2BA 002 324-021		
90 51989 3	2BA 009 001-167	4210 6H7 100	8JA 001 909-001	X 860 541 936 701	8JA 001 909-001		
90 51990 1	2BA 009 001-001	4210 6H7 100	2KA 003 389-061	X 860 582 935 311	2KA 001 386-231		
90 51990 1	2BA 009 001-007	4210 6H7 100	2KA 003 389-062	X 860 582 935 869	9GT 074 132-001		
90 51991 9	2BA 009 001-107	42106H9110	2KA 003 389-068	X 860 975 270 301	2KA 001 610-001		
90 51992 7	2PF 003 563-187	4215 6H2 430	3AF 003 399-061	X 860 975 910 001	8RA 002 016-111		
90 53966 9	2BE 003 014-251	4219 57H 140	2JA 002 661-001	X 861 019 405 550	2PF 001 634-101		
90 53966 9	2BE 003 014-257	4220 512 M91	1GA 005 060-001	X 862 171 151 431	2JA 001 330-007		
90-71340-5	2SE 002 578-701	4230 6H2 140	1GA 005 060-001	X 880 000 920 623	2JA 001 330-007		
90-71340-5	2SE 002 578-707	4240 147 M91	2ZR 003 315-041	X 880 000 920 644	2BA 001 227-211		
90-73843-6	8HG 006 294-031	4240 149 M91	1GB 006 213-101	X 880 000 920 645	8RA 002 016-111		
90-74099-4	1GB 006 213-011	4241 079 M91	1GB 006 213-107	X 880 000 920 649	2AA 001 200-001		
90-74099-4	1GB 006 213-001	4241 079 M91	2BA 002 652-121	X 880 000 920 651	2BA 001 240-301		
90-74237-0	9BG 993 345-001	4241 080 M91	2BA 002 652-111	X 880 000 921 222	2SA 001 240-331		
90-74566-2	2BE 001 259-061	4241 080 M91	2BA 002 652-117	X 880 000 921 222	2AA 001 200-021		
90-75158-7	2KA 003 188-021	4241 657 M91	2BA 002 652-127	X 880 000 922 223	2AA 001 200-011		
90752957	2SE 003 184-011	4246 417 M91	8HG 006 294-051	X 880 000 922 244	2AA 001 200-012		
90752957	2SE 003 184-017	4246 418 M91	2RL 006 846-011	X 880 000 922 245	2AA 001 200-031		
90-75300 5	2ZR 003 014-091	4246 418 M94	2RL 006 846-011	X 880 000 922 258	2SD 001 685-211		
90-79421-5	2RL 007 551-011	42T09H0380	8HG 006 294-021	X 880 000 922 260	2SD 001 685-218		
90-79422-3	8HG 006 294-041	42U06 619 140	8HG 006 294-021	X 880 000 922 262	2SE 001 685-201		
90-79921-4	2RL 006 846-011	42U06 619 140	2XW 003 146-001	X 880 000 922 269	8RA 002 016-121		
90-79933-9	2JA 004 192-001	42W 0633 160	8HG 006 294-051	X 880 000 956 474			



Manufacturer's no. / Hella no.

Cross-Reference

Ikarus	Hella	Iveco	Hella	Iveco	Hella	Iveco	Hella
700.04-0093-168	2SA 005 603-021	1162 800KZ897646	2ZR 001 193-011	2984 107	2SE 001 686-142	418 22954EC5026-80	2KA 003 389-068
700.04-0093-168	2SA 005 603-027	1169 440EF897680	2AA 001 201-011	2984 108	2BA 002 324-011	4182 3094	1NA 005 750-001
700.04-0093-169	2ZR 005 603-061	1238 217	2KA 003 010-007	2984 4108KY8751-80	2BA 002 324-011	4182 3454	2ZR 001 193-011
700.04-0093-169	2ZR 005 603-067	1262 462EZ877680	2AA 001 204-031	2984 109	2BA 002 324-021	4191 4846	8RA 002 014-031
700.04-0093-170	2NE 005 603-071	1262 567EZ877680	2AA 001 204-001	2984 4109KY8751-80	2BA 002 324-021	4191 4846	8RA 002 014-032
700.04-0093-170	2NE 005 603-077	1275 886	9GT 067 751-001	2984 397	9DR 060 567-001	4191 4894	1GA 007 506-021
700.04-0093-195	8RB 004 713-001	1275 886EY4875180	9GT 067 751-001	2984 403	9EL 102 240-031	4193 3709	2ZR 003 030-171
700.04-0093-209	2DA 005 603-031	1275 982EY875180	9EL 092 435-011	2984 405	9EL 110 918-001	419 33709KZ6927-13	2ZR 003 030-171
700.04-0093-209	2DA 005 603-037	1276 008	9GD 024 183-001	2984 405EY8751-80	9EL 110 918-001	4195 2452	2XW 003 146-001
700.04-0093-210	2BA 005 603-011	1276 024	9KS 075 307-001	0320 5388	9GH 993 988-007	4199 1420	2KA 001 386-281
700.04-0093-210	2BA 005 603-017	1286 471	2SB 003 014-151	03351866KZ8976-47	8RA 002 016-121	4199 4651	1G9 001 523-021
700.04-0093-260	2BM 006 692-011	1715 77	2XW 003 146-001	3385 820M01A	2JA 001 357-002	4199 6531	2BA 001 416-011
700.04-0093-260	2BM 006 692-017	1715 78	2AB 004 532-001	0338 6485	2AA 001 200-011	4199 65316729-80	2BA 001 416-011
700.04-0093.261	2BM 006 692-021	1739 69	9DF 112 247-001	0338 6485	2AA 001 200-012	4199 6532	2BA 001 416-021
700.04-0093.261	2BM 006 692-027	1748 21	9HD 121 297-001	0338 8059	2KA 001 389-101	4199 6532EZ6272-80	2BA 001 416-021
700.04 0093-293	1GA 007 506-001	1750 48	9DE 133 697-015	0341 6454	2SD 001 686-101	4199 7529	9EL 856 416-011
700.04 0093-293	1GA 007 506-002	1750 4800	9DE 133 697-015	3416 605	8JA 001 909-011	4199 7529EZ6700-80	9EL 856 416-011
700.04 0093-293	1GA 007 506-007	1750 49	9ES 133 697-005	3416 605	8JA 001 914-011	4201 3058	2SE 003 167-031
70004-03204	2KA 001 610-001	1750 4900	9ES 133 572-005	0341 6605 EE5041-80	8JA 001 909-011	4201 3058	2SD 003 167-021
70004-03206	2KA 001 378-001	1759 65	9EL 101 899-001	0341 6680	2PF 001 648-171	4201 3059	2SD 003 167-011
70004-03208	2KA 005 049-011	1759 66	9EL 101 900-001	0341 6722	2SD 001 685-211	4201 3060	2SE 003 167-041
70004-03208	2KA 005 049-017	1819 37	2VP 003 567-121	0341 6722	2SD 001 685-218	420 24860EZ5027-80	8RA 003 326-011
70004-05022	1KB 003 177-061	1819 37	2VP 003 567-127	341 6727KZ5026-80	2SD 001 688-141	420 24860EZ5027-80	8RA 003 326-017
70004-05235	8RL 002 009-021	1978 95	9EL 132 403-001	3440 754	9ZR 100 140-001	4202 4986	2SE 001 685-201
70004-05265	8KW 701 235-033	230 6631KZ1001-49	2SD 001 306-061	345 1057KZ5736-78	2ZR 001 240-351	4202 4987	2SD 001 685-211
70004-05407	8JD 156 150-807	230 6632KZ1001-49	2SE 001 306-051	3464 801	8HG 002 365-001	4202 4987	2SD 001 685-218
70004-05408	8KA 152 134-007	233 2194E-1001-49	9EL 104 571-041	3466 213	2KA 001 386-301	4202 5923	2SE 002 578-701
700.04-055-001	2BM 008 355-001	233 2197E-1001-49	9EL 104 571-031	0347 4671	2KA 001 389-101	4202 5923	2SE 002 578-701
700.04-055-001	2BM 008 355-007	233 9143KZ1210-49	2BA 001 259-611	0347 4671EY0909-12	2KA 001 389-101	4204 5986EZ5018-65	8RA 002 014-051
70004-07208	1ND 005 700-061	233 9143KZ1210-49	2BA 001 259-618	0347 4671EY0919-12	2KA 001 389-101	4204 5986EZ5018-65	8RA 002 014-052
70004-07218	2AB 004 532-051	236 2524KZ1041-49	2SD 002 776-231	0347 6471	2KA 001 389-101	4204 6397	8RA 003 326-011
70004-07218	2AB 004 532-057	236 2524KZ1041-49	2SD 002 776-231	3476 687	2AA 001 200-001	4204 6397	8RA 003 326-017
70004-07224	2XS 005 020-001	0236 3999KZ	2BA 003 022-001	3476 688	2AA 001 200-011	4204 7226	2BA 003 236-321
70004-07224	2XS 005 020-002	0237 2740	2PF 001 259-631	3476 688	2AA 001 200-012	4204 7226	2SA 003 236-341
70004-07224	2XS 005 020-003	237 2740KZ1210-49	2PF 001 259-631	3476 689	2AA 001 200-021	4204 7227	2BA 003 236-331
70004-14081	8RA 002 014-081	237 2742KZ1210-49	2BE 001 259-061	3476 689	2AA 001 200-023	4204 7228	2BA 003 236-321
70004-200031	2KA 001 378-001	237 7137 KZ1001-49	2SD 002 776-241	3478 683	9FF 085 642-001	4204 7229	2ZR 003 236-311
70004-20011	2BM 006 692-011	237 7137 KZ1001-49	2SD 002 776-247	0348 9142	2JA 001 346-011	4204 8298	8RA 002 014-051
70004-20011	2BM 006 692-017	2377 139KZ1001-49	2SE 002 776-211	3505 853	2AA 001 200-031	4204 8298	8RA 002 014-052
70004-20021	2BM 006 692-021	2377 139KZ1001-49	2SE 002 776-217	3522 674	2AB 001 208-001	4206 8086	1G8 002 340-011
70004-20021	2BM 006 692-027	237 7448KZ1001-49	2BE 002 776-251	3540 288	1G3 996 001-331	4206 9984	9GH 126 647-011
70004-21007	2BA 008 221-001	237 7448KZ1001-49	2BE 002 776-257	3814 569	9GD 856 863-001	4207 3886	8RA 002 014-101
70004-21007	2BA 008 221-007	237 7450KZ1001-49	2BE 002 776-261	4105 4985	2PS 003 748-121	4208 0296	3AG 003 399-101
70004-54007	9GH 152 654-007	237 7450KZ1001-49	2BE 002 776-267	4105 4985	2PS 003 748-127	4208 0316	2ZR 004 542-001
70004-55001	2BM 008 355-001	238 1669EZ1210-49	9EL 109 208-011	4120 0525	2SE 001 685-201	420 80316ED7623-34	2ZR 004 542-001
70004-55001	2BM 008 355-007	238 1675EZ1210-49	9EL 088 538-001	4120 0526	2SD 001 685-211	4209 9026	2BA 002 324-021
70004-60307	2BA 005 603-001	238 9569KZ1001-49	2SE 002 776-211	4120 0526	2SD 001 685-218	4221 5556	2VP 003 567-111
70004-60307	2BA 005 603-007	238 9569KZ1001-49	2SE 002 776-217	4120 0761	1G3 005 760-021	4221 5557	2VP 003 567-121
70004-64010	2PS 963 639-011	238 9571KZ1001-49	2SD 002 776-241	4120 0761	8NS 007 560-021	4221 5557	2VP 003 567-127
70004-64010	2PS 963 639-017	238 9571KZ1001-49	2SD 002 776-247	4120 0762	2RL 008 063-111	4221 8387	2SE 002 578-701
70004-64011	2PS 962 964-012	2400 1590	2RL 007 900-561	4120 0763	8HG 006 294-021	4221 8387	2SE 002 578-707
70004-64011	2PS 962 964-018	2462 141	8JA 001 914-011	4157 2338	2BA 003 022-021	422 20069EY5759-80	2ZR 002 589-011
70004-64012	9GT 963 129-001	0248 0679	2BA 001 277-011	4157 6613	2DA 003 014-031	4222 5071	2PS 006 717-031
70004-64013	9GD 963 281-001	0248 0680	2BA 001 277-021	4157 6613	2DA 003 014-037	4222 5071	2PS 006 717-032
70004-67011	2SA 961 167-011	2480 751	2SE 001 699-071	4157 6613	2SW 003 014-131	4222 5071	2PS 006 717-037
70004-67021	2PF 961 167-021	0248 0751KZ5026-80	2SE 001 699-077	4160 184	2BA 003 236-541	4222 5177	2JA 004 531-011
70004-69001	2DA 964 169-001	2480 752	2SD 001 699-061	4162 2525	2ZR 003 014-091	4222 5226	2ZR 003 236-311
70004-69001	2DA 964 169-007	2481 978	2NE 001 423-011	4162 2525EE6927-13	2ZR 003 014-091	4222 5777	2XS 005 020-001
70004-69011	2BA 964 169-011	248 1978KZ5026-80	2NE 001 423-011	4162 2580	2JA 007 373-107	4222 5777	2XS 005 020-002
70004-69021	2BA 964 169-017	2481 980	2ZR 001 423-001	4162 3679	2KA 001 389-101	4222 5777	2XS 005 020-003
70004-69021	2NE 964 169-021	248 1980KZ5024-80	2ZR 001 423-001	4162 3679	2KA 003 389-061	4222 6126	1NE 002 537-201
70004-69021	2NE 964 169-027	0248 2092	1NE 006 300-051	4162 3679	2KA 003 389-062	4222 6181	2PF 006 679-001
70004-69031	2ZR 964 169-031	2506 751	2ZR 001 240-351	4162 3679	2KA 003 389-068	423 04484KZ5763-76	2BA 003 236-021
70004-69031	2ZR 964 169-037	250 6751KZ5024-80	2ZR 001 240-351	4162 3979	2JA 007 372-001	423 04484KZ5763-76	2BA 003 236-027
70004-69081	2SW 964 169-081	2506 753	2BA 001 240-301	4162 4870	6ZE 001 759-071	4230 4485	2SA 003 236-041
70004-69081	2SW 964 169-087	250 6753KZ5025-80	2BA 001 240-301	4162 4924	2NE 006 609-001	4230 4485	2SA 003 236-047
70004-69091	2SA 964 169-091	250 6755KZ5026-80	2SB 001 240-311	4162 4924	2NE 006 609-007	4230 4485	2SA 003 236-048
70004-69091	2SA 964 169-097	250 6757KZ5026-80	2DA 001 240-341	4162 4928	2ZR 006 609-081	4230 4485	2SA 003 236-041
70004-71737	2DA 959 071-737	0250 6759	2SA 001 240-331	4162 4928	2ZR 006 609-087	4230 4485KZ5763-76	2SA 003 236-047
70004-86047	1NL 007 186-047	2506 759KZ5027-80	2SA 001 240-331	4162 5266	1GB 006 213-111	4230 4485KZ5763-76	2SA 003 236-048
70004-91027	1KO 008 191-021	2525 487	6EG 001 567-041	4162 5266	1GB 006 213-117	423 04486KZ5763-76	2SA 003 236-031
70004-91027	1KO 008 191-027	2525 995	2KA 001 386-231	4162 8725	2SD 003 167-011	423 04486KZ5763-76	2DA 003 236-037
70004-93114	2DA 007 421-001	0253 4403	2KA 001 389-101	4162 8726	2SD 003 167-021	4230 4487	2NE 003 236-001
70004-93114	2DA 007 421-007	0253 4404	2KA 001 389-101	4162 8727	2ZR 003 236-051	4230 4487	2NE 003 236-008
70004-93115	8KA 146 751-007	0256 3885	2PF 001 648-171	4162 8727	2ZR 003 236-057	4230 4487	2NE 003 236-001
70004-93168	2SA 005 603-021	2593 626	2KA 001 386-291	4162 8728	2BA 003 236-021	423 04487KZ5763-76	2NE 003 236-008
70004-93168	2SA 005 603-027	0259 3628	2SD 001 693-011	4162 8728	2BA 003 236-027	4230 4488	2ZR 003 236-051
70004-93169	2ZR 005 603-061	259 3628KZ5762-76	2SD 001 693-011	4162 8729	2NE 003 236-001	423	

Manufacturer's no. / Hella no.

Cross-Reference



Iveco	Hella	Iveco	Hella	JOHN DEERE	Hella	JOHN DEERE	Hella
4253 3016	2JA 002 661-001	5040 19896	2XW 007 146-011	10 50 66	2NE 003 236-001	50 65 69	8JA 001 921-102
4255 6591	2JA 007 372-011	5041 27393	2SD 964 169-111	10 50 66	2NE 003 236-008	50 66 34	2AB 004 532-001
4282 3678	2PS 002 727-001	5041 27393	2SD 964 169-117	10 50 79	2KA 001 610-001	53 50 50	2SE 002 578-701
4282 3678EY8776-54	2PS 002 727-001	0514 5801701	8JA 001 909-011	10 51 27	8RA 003 326-001	53 50 50	2SE 002 578-707
4390	1S3 001 117-041	6125 8222	1N4 005 750-041	10 51 27	8RA 003 326-002	53 53 08	2SD 003 182-061
4390 KY8751-80	1S3 001 117-041	6126 1542	2XW 002 897-051	10 51 35	2XS 005 020-001	53 53 08	2SD 003 182-067
4461 731	8XH 002 975-017	680 966	9EL 087 769-001	10 51 35	2XS 005 020-002	53 53 09	2SD 003 182-051
0470 7925EY9999-99	2PF 961 167-021	6890 81	9HD 121 297-001	10 51 35	2XS 005 020-003	53 53 09	2SD 003 182-057
4833 768	2SA 001 259-751	6950 1645	9AH 157 659-007	10 52 06	8HG 002 365-001	55 02 4	3AG 003 399-081
4833 768	2SA 001 259-757	6950 1646	1N0 008 582-001	10 52 36	2SW 003 014-131	55 02 8	3AG 003 399-101
0483 3768EC7620-37	2SA 001 259-751	6950 1646	1N0 008 582-007	10 61 97	8RA 003 326-011	55 31 5	8HG 854 516-001
0483 3768EC7620-37	2SA 001 259-757	69501903	6NM 007 282-221	10 61 97	8RA 003 326-017	56 00 5	9EL 852 820-001
5000 2085	8GD 002 078-241	7017 0	2PS 004 361-001	10 61 98	8RA 003 326-041	56 01 1	9GD 856 863-001
5000 22085	8GD 002 078-241	7017 0	2PS 004 361-007	10 61 98	8RA 003 326-047	56 20 9	1G4 003 470-001
5000 821813	2KA 003 168-021	7017 0	2PS 006 717-051	10 66 69	2XS 004 237-291	56 21 0	1G5 003 241-021
5001021036	1K0 008 191-021	7017 0	2PS 006 717-057	10 66 70	2XS 004 237-301	56 40 6	2SA 001 638-021
5001021036	1K0 008 191-027	0007 0235	9GD 856 863-001	10 73 65	2SW 003 014-131	56 41 7	2BA 002 652-111
5001 021038	1NL 007 166-047	7101 621301	8JA 001 909-001	11 03 24	2JA 002 661-001	56 41 7	2BA 002 652-117
5001 021039	2PF 961 167-021	7696 92	2SE 003 167-041	11 03 38	2SK 003 567-331	56 41 8	2BA 002 652-121
5001 021041	2PS 962 964-012	7696 93	2SE 003 167-031	11 03 39	2SK 003 567-321	56 41 8	2BA 002 652-127
5001 021041	2PS 962 964-018	7816 5701	2VP 003 567-121	11 05 44	2XS 005 020-081	56 42 9	2BA 003 022-021
5001 021044	2BM 008 355-001	7816 5701	2VP 003 567-127	11 23 84	8JA 001 925-001	56 62 1	2JA 001 357-012
5001 021044	2BM 008 355-007	7984 876	6ED 708 919-001	11 91 47	2SL 003 567-311	56 63 7	2AB 004 532-001
5001021045	2BA 008 221-001	8119 043	2KA 004 525-001	12 21 70	2SA 003 057-021	56 63 8	2AB 004 532-051
5001021045	2BA 008 221-007	0816 8785	8JA 003 526-001	10 21 26	2BA 002 324-001	56 63 8	2AB 004 532-057
5001 021053	8RA 002 014-081	9121 3926	1LG 005 480-075	12 51 5	2ZR 004 542-001	56 64 4	2NE 002 589-001
5001 826876	1ND 005 700-061	9121 3929	1LG 005 480-031	01 31 72	9EL 854 912-001	56 66 5	2ZR 004 542-001
5001 842626	9XB 136 202-005	9121 3929	1LG 005 480-041	00 13 34	2SA 003 057-021	56 66 7	2ZR 002 589-011
5002 46293	2BE 003 014-251	9201 69	2TJ 001 633-211	00 13 35	2PF 003 057-041	56 95 2	9FF 085 081-001
5002 46293	2BE 003 014-257	9201 6900	2TJ 001 633-211	14 08 9023	2SD 001 680-281	57 05 0	6ZE 001 759-071
5002 50590	2XW 007 146-011	9223 09	1FE 006 300-081	14 09 4022	2SK 003 567-331	57 05 2	6ED 004 778-011
500251217	9XS 027 639-001	9319 1714	9EL 119 544-021	14 12 9023	2ZR 003 236-051	05 72 1352	2PF 003 014-071
5002 51298	1GA 996 142-221	9319 1715	9EL 119 544-001	14 12 9023	2ZR 003 236-057	05 72 1356	9EL 115 003-001
5002 51299	9XS 027 639-001	9319 1716	9EL 119 544-031	14 13 0022	2SD 001 699-511	05 72 2006	2BE 003 185-031
5002 51320	2RL 008 181-011	9319 1717	9EL 120 201-001	01 43 75	8JA 003 526-001	05 72 2007	9EL 119 397-001
5002 51321	2RL 008 181-111	9319 1718	9EL 119 544-111	14 58 3023	2SA 003 057-021	05 72 6806	2BA 002 014-011
5002 51343	2RL 008 183-011	9333 870	2PF 001 638-011	14 72 3022	2NE 003 236-001	05 72 7807	9EL 110 536-011
5002 53050	1HS 998 502-002	9384 985	1LG 005 480-031	14 72 3022	2NE 003 236-008	05 72 7078	8RA 002 015-031
5002 53051	8HG 998 519-002	9384 986	1LG 005 480-041	01 52 04	2AB 004 532-021	57 M6 274	8GM 002 092-121
5002 53078	2XD 009 475-001	9384 988	2BA 005 481-001	01 52 10	1G5 003 241-021	57 M6 394	8GP 002 067-121
5002 53079	2XD 009 475-001	9638 8230	2PS 002 727-001	15 93 4032	8RA 002 010-011	57 M6 494	8GP 002 067-121
5002 53134	9SX 863 114-001	9641 800	2JA 003 231-001	16 51 4023	2SD 001 685-211	57 M6 498	8GA 002 071-121
5002 53135	8HG 863 383-001	0965 1052	2PF 001 648-161	16 51 4023	2SD 001 685-218	57 M6 844	8GD 002 088-131
5002 53285	9MM 862 358-801	9944 6124	2SE 001 685-221	16 51 6022	2SD 001 699-061	57 M7 011	8GD 002 078-121
5002 53286	8KB 863 324-001	9944 6124	2SE 001 685-227	16 51 7023	2SD 003 167-011	57 M7 013	8GA 002 071-131
500254090	2RL 008 065-011	9944 6125	2SD 001 685-231	16 51 8023	2SE 001 685-201	57 M7 014	8GA 002 071-121
500254091	2RL 008 065-111	9944 6125	2SD 001 685-232	16 51 9022	2SE 001 699-071	57 M7 016	8GH 002 089-133
500254097	2RL 008 061-011	9944 6126	2XS 950 071-031	16 52 0022	2SE 003 167-031	57 M7 089	8GM 002 092-121
5002 54098	2RL 008 061-111	9946 3242	2VP 008 204-181	16 52 1023	2SD 003 167-021	57 M7 166	8GJ 002 525-131
500257038	2KA 005 049-011	9946 3243	2VP 008 204-181	01 70 51	2SB 001 673-002	57 M7 182	8JA 003 526-001
500257038	2KA 005 049-017	9946 3244	2VD 008 204-191	01 70 52	1TA 003 570-101	57 M7 504	8GM 002 091-131
5002 58415	1GA 998 532-011	C877 6801310	2SE 001 686-142	01 71 39	8RA 002 015-031	57 M7 615	8GM 002 092-121
5002 58416	1GA 996 142-071	C877 6801320	2SD 001 686-101	00 17 70	8RA 002 014-051	57 M9 328	8GH 008 358-121
5002 58460	1GA 007 506-011	D 1125-49-27 20	2BE 003 018-011	00 17 70	8RA 002 014-052	79 69 723	8HG 002 365-001
5002 58460	1GA 007 506-012	D 1155-49 22 10	2SB 003 018-031	00 17 80	8RA 003 326-011	79 92 285	8XS 002 500-011
5002 58466	2PF 959 590-401	E175 0490124	8RA 002 016-121	00 17 80	8RA 003 326-017	80 79 003	2JA 003 354-001
5002 58466	2PF 959 590-407			18 06 7023	2XS 005 020-021	80 80 055	8RA 003 326-051
5002 58584	1GA 996 142-091	J.C.B.	Hella	18 06 9023	2XS 005 020-001	80 80 082	9FF 078 830-001
5002 58584	1GA 996 142-221	700/23000	1GA 998 522-011	18 06 9023	2XS 005 020-002	80 80 255	8RA 003 326-041
5002 59150	2PF 964 295-021	700/31800	1GA 996 082-001	18 06 9023	2XS 005 020-003	80 80 255	8RA 003 326-047
5002 59150	2PF 964 295-027	700/32200	1GA 006 991-041	19 80 8019	6ZE 001 759-051	87 52 297	9GH 096 532-001
5002 59288	2PS 008 541-801	700/34600	1GB 996 080-001	19 81 2023	2XS 005 020-011	AH 13 4125	2BA 002 652-121
5002 59344	1GA 996 142-011	700/34700	1GA 006 991-041	19 81 2023	2XS 005 020-017	AH 13 4125	2BA 002 652-127
5002 59502	9EL 115 003-055	700/35200	1GA 998 522-011	19 82 6067	3AG 003 399-081	AH 13 4125	9BC 990 297-001
5002 66328	1G4 003 470-141	700/38800	1GA 007 506-001	21 29 4	2BA 003 022-001	AL 11 0365	2JA 001 357-002
5002 66328	1G4 003 470-147	700/38900	1GA 007 506-002	25 56 4108	9XS 027 639-001	AL 11 7065	1GA 998 525-001
5002 67109	9ES 861 711-001	700/38800	1GA 007 506-007	22 66 0068	9EL 122 772-001	AL 13 659	2BE 001 259-061
5002 67117	2XD 862 019-011	700/40400	1GB 996 080-011	24 22 6019	8JB 004 777-001	AL 14 203	9DR 090 206-001
5002 67119	9ES 862 011-001	700/42300	1GB 996 080-011	24 22 6019	8JB 004 777-002	AL 15 005	9DR 060 567-001
5002 67969	9EL 120 201-001	700/42500	1GA 006 875-001	24 23 0067	2JA 004 531-001	AL 15 2459	1GA 998 525-011
5002 67970	9EL 119 544-111	700/42600	1GA 006 875-001	24 95 4999	9GD 087 883-355	AL 154 988	2KA 998 523-117
5002 67971	9BG 121 740-001	700/42700	1GA 006 875-001	00 36 11	2BA 003 014-011	AL 158 141	2XT 959 510-467
5002 68796	2SA 003 236-041	700/42800	1GA 007 506-001	00 45 40	2ZR 003 030-171	AL 161 607	2KA 998 523-117
5002 68796	2SA 003 236-047	700/43900	1GA 007 506-002	46 07 0947	2SB 003 018-031	AL 16 2349	2TJ 001 633-211
5002 68796	2SA 003 236-048	700/43900	1GA 007 506-007	46 07 1425	9EL 089 114-001	AL 16 6982	2BA 008 221-001
5002 68798	2DA 003 236-031	700/50022	1GA 007 506-001	00 49 02	2JA 004 531-011	AL 16 6982	2BA 008 221-007
5002 68798	2DA 003 236-037	700/50022	1GA 007 506-002	50 50 83	9EL 052 476-001	AL 16 6982	2BA 008 221-107
5002 68800	2BA 003 236-021	700/50022	1GA 007 506-007	50 50 95	9EL 112 743-001	AL 16 6982	2BA 008 221-147
5002 68800	2BA 003 236-027	700/50029	1GA 007 506-001	50 50 96	9EL 112 741-001	AL167631	2AA 008 594-031
5002 70089	2NE 003 236-301	700/50029	1GA 007 506-391	50 51 05	2PF 001 650-001	AL 17 1450	8RA 002 014-081
5002 70089	2NE 003 236-307	700/50063	1GA 007 506-391	50 51 09	8RA 002 016-101	AL23015	2AA 003 257-021
5003 03366	8RA 003 326-031	700/50077	1GA 007 506-391	50 51 12	2PF 003 057-001	AL 24 042	6ED 708 919-001
5003 19555	2SK 008 208-061	700/50077	1GA 996 083-001	50 51 15	2KA 001 622-00		



Manufacturer's no. / Hella no.

Cross-Reference

JOHN DEERE	Hella	JOHN DEERE	Hella	Jungheinrich	Hella	Jungheinrich	Hella
AL 31 621	2SB 003 014-151	RE 20 0798	8GM 002 091-131	16025850	8GP 002 066-241	50150050	8GA 002 074-121
AL 32 067	8RA 123 251-005	RE 26 9637	1GB 996 186-061	16028430	2SA 003 057-021	50150570	2XW 003 146-001
AL 32 071	2SE 003 184-011	XA H1 34124	2BA 002 652-111	16028440	8GM 002 092-241	50151189	8GD 002 088-131
AL 33 161	2KA 003 389-061	XA H1 34124	2BA 002 652-117	16029020	1GA 005 060-041	50152223	1TA 003 570-001
AL 33 161	2KA 003 389-061	XA H1 34125	2BA 002 652-121	16036350	1GA 005 060-041	50152680	8RA 002 023-001
AL 33 161	2KA 003 389-062	XA H1 34125	2BA 002 652-127	16172560	1GA 007 506-021	50152682	2JA 001 330-001
AL 35 176	2SD 003 184-031	Z 21 973	2AA 001 200-011	18364	8GA 002 071-251	50152682	2JA 001 330-007
AL 35 176	2SD 003 184-037	Z 21 973	2AA 001 200-021	18720	8GA 002 073-241	50153283	1G4 003 470-031
AL 37 714	8JA 001 909-001	Z 21 974	2AA 001 200-023	18726	8GA 002 073-121	50155346	8RA 002 010-011
AL 55 738	8JA 003 526-001	Z 21 975	2AA 001 200-001	19265	2BA 003 014-011	50160849	9EL 112 858-011
AL 58 729	2BE 003 014-251	Z 27 83	9KS 075 307-001	23902	2BA 002 652-101	50195185	2KA 004 525-001
AL 58 729	2BE 003 014-257	Z 37 14	9EL 854 912-001	23902	2BA 002 652-107	50198056	8GJ 002 525-251
AL 58 739	2BE 003 014-251	Z 49 15	9EL 854 912-001	025416	1G4 003 470-031	502040141	2SD 003 184-031
AL 58 739	2BE 003 014-257	Z 49 15	9EL 120 201-001	002587	1G3 005 760-001	502040141	2SD 003 184-037
AL 59 724	2KA 001 389-101	Z 49 15	9GH 126 647-011	26903023	2BA 002 652-101	50204141	2SD 003 184-031
AL 60 127	2BE 003 182-091	Z 5 192	9GH 096 532-001	26903023	2BA 002 652-107	50204141	2SD 003 184-037
AL 60 128	2BE 003 182-101	Z 75 467	9EL 990 186-001	26903225	2KA 001 389-101	50204142	2SD 003 184-041
AL 64 593	2KA 003 738-057	Z 75 468	9EL 860 627-001	26906440	8GA 002 083-251	50204142	2SD 003 184-047
AL 67 206	2SD 002 776-241	Z 75 88	8GH 007 157-121	27145	2DA 003 014-031	50212531	2BE 003 014-251
AL 67 206	2SD 002 776-247	Z 10 006	1GA 005 060-001	27145	2DA 003 014-037	50212531	2BE 003 014-257
AL 67 207	2SE 002 776-211	Jokon	Hella	28300060	8GP 002 068-241	50229023	8GH 002 089-133
AL 67 207	2SE 002 776-217	10.1002.000	2SE 004 623-001	28300130	8GD 002 084-131	50234908	8GJ 002 525-131
AL 67 208	2SD 002 776-231	10.1002.100	2SE 004 623-007	28300160	8GM 002 092-121	50236485	9EL 856 010-001
AL 67 208	2SD 002 776-237	10.1004.002	2SD 001 685-211	28300711	8GA 002 074-121	50260000	9GH 993 984-001
AL 75 393	1GA 005 060-001	10.1004.102	2SE 001 685-201	28301140	2RL 008 061-111	50298227	2SD 001 679-001
AL Y4 3450A	1GD 003 590-701	10.1014.011	2SE 003 184-011	28301690	9FF 090 500-001	50308042	9EL 112 743-001
AT130 104	8GH 002 090-133	10.1014.011	2SE 003 184-017	28303350	8GM 002 091-121	50352227	2SD 007 506-001
AT 24 692	2AA 008 594-031	10.1014.021	2SE 003 184-011	28303540	2BA 003 014-011	50352227	1GA 007 506-002
AT 27 371	2AA 008 594-021	10.1023.001	2SD 004 460-011	28304140	8GA 002 083-131	50352227	1GA 007 506-007
AT 32 246	2SE 001 679-051	10.1023.001	2SD 004 460-011	28304390	8GA 002 073-241	50409964	8GA 002 073-241
AT 32 247	2SD 001 679-001	10.2008.001	2SD 004 460-001	28304760	8GP 002 067-241	50422871	2DA 996 012-041
AZ 10 3535	2AA 008 594-021	10.2008.001	2SD 004 460-001	28304810	2JA 004 531-011	50423347	2SD 997 131-051
AZ 10 4309	2BM 003 563-111	10.2009.001	2SK 004 460-041	28304900	2AB 004 532-001	50423369	2ZR 002 985-261
AZ 10 792	2BA 001 227-201	10.2010.001	2SK 004 460-031	28304910	8GA 002 074-241	50423370	8GD 002 078-241
AZ 13 377	2PF 001 634-101	10.2010.001	2SK 004 460-037	28304910	8GH 002 090-251	50436549	2JA 007 372-011
AZ 23 618	2BA 003 014-111	11.0001.000	2BE 003 185-031	28304940	8GH 002 090-253	50451992	8GD 002 078-221
AZ 28 085	8JA 001 914-011	12.0002.001	2TJ 001 633-211	28304950	8GA 002 071-271	50453770	8GD 002 088-131
AZ 30 044	2SA 001 259-751	13.1006.000	2BA 001 259-611	28304950	2SD 003 184-031	50468122	2SW 003 014-131
AZ 30 044	2SA 001 259-757	13.4001.101	2KA 001 389-101	28305120	2SD 003 184-037	50468123	8GM 002 092-241
AZ 31 113	1GD 003 590-701	13.4001.101	2KA 003 168-021	28305250	8GA 002 071-241	510026218	8GS 002 296-101
AZ 34 621	8JB 850 434-011	13.4002.100	2KA 001 386-231	28305560	2BA 003 022-021	51004920	4AZ 003 787-021
AZ 35 474	2SA 003 236-041	13.4002.110	2KA 001 386-281	28305710	2PF 003 389-037	5106218	8GS 002 296-101
AZ 35 474	2SA 003 236-047	13.4002.130	2KA 001 386-301	28305750	8GP 002 095-241	51016318	2SD 343 130-397
AZ 35 474	2SA 003 236-048	13.4006.100	2KA 003 389-061	28306140	9EL 854 912-001	51016328	2SD 343 130-227
AZ 39 131	2XS 005 020-001	13.4006.120	2KA 003 389-001	28306400	2ZR 003 014-091	51017428	1GA 996 361-421
AZ 39 131	2XS 005 020-002	13.4008.100	2KA 004 331-031	28306430	8GH 002 473-151	51017429	1GA 996 361-431
AZ 39 131	2XS 005 020-003	13.5001.000	2PF 001 634-101	28306510	8RA 002 014-081	51024815	9EL 862 141-001
AZ 41 570	1GB 006 213-107	13.5003.000	2PF 001 648-161	28306510	2DA 003 014-031	51026926	2RL 006 846-001
AZ 41 571	1GB 006 213-117	16.0005.002	2RL 006 846-001	28306630	2DA 003 014-037	51061360	1RG 996 176-021
AZ 42 982	2BE 003 347-001	16.0005.012	2RL 006 846-011	28306740	8GM 002 092-241	51067163	8GS 007 949-101
AZ 44 705	2RL 006 846-001	19.0003.000	9EL 118 633-001	28306750	8HG 003 799-001	51079581	2BA 002 652-111
AZ 46 922	9EL 859 020-001	19.0003.200	9EL 119 397-001	28306760	1TA 003 570-101	51079581	2BA 002 652-121
AZ 46 924	9GP 859 115-001	19.0007.000	9EL 129 519-001	421-440051419	2SA 003 057-021	51079584	2BA 002 652-127
AZ 50 274	2BA 002 324-001	19.2101.002	8HG 005 436-011	440050164	2BA 003 014-111	51079584	8GH 002 089-361
AZ 51 917	2SB 003 014-151	19.2102.012	8HG 006 294-011	440054642	8RA 002 014-031	51097232	2PT 965 039-171
AZ 55 251	4RA 003 530-001	19.2107.002	9EL 859 020-001	440054642	8RA 002 014-032	51111521	2PT 965 039-177
AZ 55 466	1GB 996 080-021	30.0003.000	8RA 002 014-031	440056314	2KA 001 389-101	51113392	4DM 009 492-001
AZ 55 467	1GA 007 506-001	30.0003.010	8RA 002 014-051	440072055	2SD 001 305-021	51114681	2ZR 003 014-091
AZ 55 467	1GA 007 506-002	30.0003.020	8RA 002 014-041	440073217	2ZR 003 014-091	51116444	2RL 008 060-111
AZ 55 467	1GA 007 506-007	30.0006.000	8RA 002 014-081	440075253	8GH 002 090-133	05112186	2SD 001 679-001
AZ 55 467	1GA 007 506-651	30.0006.010	8RA 002 014-101	440075509	8GM 002 091-241	51129353	8GH 007 157-241
AZ 55 633	2RL 007 552-001	30.0006.020	8RA 002 014-091	440075513	4AZ 003 787-021	51134940	1GA 007 506-001
AZ 55 633A	2RL 007 552-001	30.0007.020	8RA 002 016-101	44057072	2DA 003 014-031	51134940	1GA 007 506-002
AZ 56 237	1LA 993 975-117	31.0001.000	8RA 002 023-001	44057072	8GM 002 092-121	51134940	1GA 007 506-007
AZ 56 322	2RL 007 552-001	31.0001.010	8RA 002 023-021	449090012	8GP 002 067-121	5116723	1GA 007 506-007
AZ 56 492	1LB 007 145-047	31.0001.020	8RA 002 023-011	449090042	8GP 002 067-241	51169570	9GH 993 984-001
AZ 56 595	2JA 001 330-031	31.0004.000	8RA 003 326-031	449090067	8GP 002 083-251	51170180	8GP 003 594-121
AZ 57 444	8RA 003 326-031	31.0004.010	8RA 003 326-041	449090074	8GP 002 085-121	51170258	8GH 007 157-121
AZ 59 790	1LB 006 213-057	31.0004.020	8RA 003 326-051	449090076	8GA 002 092-121	51172458	8GA 006 841-121
AZ 59 791	1GA 007 506-061	31.0008.000	8RL 002 009-021	449090084	8GM 002 091-121	51172458	2NE 959 011-501
AZ 59 958	2BE 997 131-081	31.0008.010	8RL 002 009-011	449090087	8GA 002 073-121	51187837	2NE 959 011-507
AZ 61 045	1LA 990 185-011	32.0002.000	8RA 003 503-001	449090088	8GA 002 073-241	52021959	8GP 008 285-001
AZ 61 047	9MN 860 677-001	32.0004.000	8RA 002 020-001	4565385	8GH 002 089-251	52030617	2JA 006 447-041
AZ 61 159	2XS 950 071-031	61.0015.001	8JB 004 777-001	4565385	8GH 002 089-253	52030665	2AB 004 532-031
AZ Y1 0001	1VB 005 444-037	Jungheinrich	Hella	4991783	8RA 002 014-081	083.0029	8GP 002 067-241
AZ Y7 5217	2JA 003 115-001	12765	8GP 002 095-121	50011267	2SE 002 578-701	0830071	2KA 001 386-281
AZ Y7 53658	1GB 006 213-117	14038590	2ST 003 018-061	50011267	2SE 002 578-707	0830141	8GA 002 074-121
AZ Y7 5365A	1GB 006 213-101	14038790	4RA 933 791-061	50011268	2ZR 003 030-171	0830159	8GP 002 067-121
AZ Y7 5365A	1GB 006 213-107	1404469	8RL 002 009-021	50011360	8GA 002 071-251	083.0471	8GA 002 076-241
CE 14 020	9FF 078 830-001	14044690	8RL 002 009-021	50012742	8GA 002 074-241	0830494	2SD 003 184-031
DD 11 491	2KA 001 389-101	14048950	2BA 003 014-111	50015918	2SE 004 623-001	0830495	2SD 003 184-037
DD 12 056	2KA 001 386-281	14051130	8RA 002 014-031	50035528	2SB 003 014-151	0830496	2SD 003 184-041
FO 05 273	8GA 002 071-251	14051130	8RA 002 014-032	50035531	8GA 002 073-121	0830496	2SD 003 184-047
FO 11 328	8GA 008 901-241	14053840	1S5 003 178-431	50035540	8GP 002 095-121		
FO 24 690	2JA 003 236-357	14087530	8GM 002 091-14				

Manufacturer's no. / Hella no.

Cross-Reference



Karmann	Hella	Kässbohrer	Hella	Kässbohrer	Hella	Klöckner-Humboldt-Deutz	Hella
802460	2PS 962 964-031	7.521.421.000.0	2RL 007 337-001	8.689.032.000	8RA 002 020-002	237 7139KZ	2SE 002 776-217
802460	2PS 962 964-037	7.521.422.000.0	2RL 007 337-111	8.689.032.000	8RA 002 020-003	023 77448	2BE 002 776-251
802819	9GT 963 129-001	7.521.423.000.0	2RL 007 337-041	8.689.040.000	8RA 002 014-051	023 77448	2BE 002 776-251
803655	6EH 004 406-032	7.521.425.000.0	2RL 006 846-001	8.689.040.000	8RA 002 014-052	023 77448KZ	2BE 002 776-251
803864	2KA 001 378-127	7.521.427.000.0	2RL 007 550-011	8.689.057.000.0	8RA 002 014-081	237 7448KZ	2BE 002 776-251
804280	2DA 008 136-017	7.522.004.000	2SW 003 014-131	8.933.741.011	2BA 001 275-021	023 77450	2BE 002 776-257
804281	8KA 146 751-007	7.522.010.000.0	2BA 003 236-541	8.933.741.015.0	2BM 004 965-801	237 7450KZ	2BE 002 776-261
808088	8RA 004 412-001	7.525.123.000	2SD 003 184-041	8.933.741.100	2JA 001 335-011	023 77450K	2BE 002 776-261
808413	2ZR 003 236-051	7.525.123.000	2SD 003 184-047	8.933.741.104	2PS 006 717-031	237 7450KZ	2BE 002 776-261
808413	2ZR 003 236-057	7.526.009.000.0	2SE 006 040-011	8.933.741.104	2PS 006 717-032	023 81669	9EL 109 208-011
821 954	2AA 003 257-041	7.526.009.001.0	9GD 102 484-001	8.933.741.104	2PS 006 717-037	237 7450KZ	2BE 002 776-267
821 954	2AA 003 257-042	7.526.010.000.0	2SD 006 040-041	8.933.741.204	2SK 003 567-651	023 81675	9EL 109 208-011
822 051	2JA 003 232-011	7.526.010.000.000	2SD 006 040-041	8.933.741.204	2SK 003 567-661	238 1669EZ1210-49	9EL 088 538-001
824 301	2JA 001 364-001	7 526 111 000	2NE 002 589-001	98 354 006	2ZR 002 589-011	023 81678	9EL 088 538-001
824 306	8RA 003 326-001	7 526 111 004	9EL 112 763-001			023 81678	9GT 005 166-001
824 306	8RA 003 326-002	7.526.122.000	2SD 003 184-031			238 1669EZ1210-49	9GT 005 166-001
824 418	2KA 003 389-001	7.526.122.000.0	2SD 003 184-037			280 390070	1GA 996 161-121
824 418	2KA 003 389-061	7.526.122.000.0	2SD 003 184-031			2.8039.110.0/01	1GA 007 506-111
824 418	2KA 003 389-062	7.526.122.000.0	2SD 003 184-037			280 39160.3	1GA 007 506-121
824 418	2KA 003 389-068	7 526 122 004	9EL 118 700-001			280 392950	1GA 007 506-001
827 092	2PF 003 057-001	7.526.122.004.0	9EL 118 700-001			280 392950	1GA 007 506-002
828 500	2SA 003 236-041	7 526 123 000	2SD 003 184-041			280 392950	1GA 007 506-007
828 500	2SA 003 236-047	7 526 123 000	2SD 003 184-047			280 392960	1GA 007 506-001
828 500	2SA 003 236-048	7.526.123.000.0	2SD 003 184-041			280 392960	1GA 007 506-002
828 621	8RA 002 020-001	7.526.123.000.0	2SD 003 184-047			280 392960	1GA 007 506-007
828 621	8RA 002 020-002	7 526 123 004	9EL 118 701-001			280 392960	1GA 996 161-121
828 621	8RA 002 020-003	7.526.123.0040	9EL 118 701-001			2.8210.004.0	8GA 002 083-131
828 629	8HG 002 247-001	7.526.134.000	2SE 003 184-011			029 14462	2SB 001 301-021
		7.526.134.000	2SE 003 184-017			306 1399M8	2BE 003 018-011
		7.526.134.000.0	2SE 003 184-011			031 46605	8JA 001 909-011
		7.526.134.000.0	2SE 003 184-017			320 3633900	8HG 002 365-001
		7.526.134.004.0	9EL 118 697-001			034 16605	8JA 001 909-011
		7.526.319.000	2SK 003 567-331			341 6605EE5145-80	2DA 003 014-031
		7.526.319.004	9EL 122 772-001			415 3200021	2DA 003 014-037
		7.526.325.000	2XL 004 762-001			415 3200022	2BA 003 014-011
		7.526.325.000.0	2XL 004 762-001			043 08791	2JA 001 357-002
		7.526.325.004.0	9EL 136 833-001			043 16450	2SD 001 693-011
		7.526.325.012.0	2SE 004 623-001			431 6450KY1006-49	2SD 001 693-011
		7.526.325.012.0	2SE 004 623-007			043 22879	9FF 111 606-021
		7.526.325.204.0	9EL 129 519-001			432 2879EY1024-49	9FF 111 606-021
		7.526.326.000.0	2SW 964 169-081			043 24753	2KA 001 389-101
		7.526.327.000.0	2SW 964 169-087			043 24891	1G3 996 001-271
		7.526.327.000.0	2NE 964 169-021			043 36132	9GD 120 670-001
		7.526.328.000.0	2NE 964 169-027			433 6132EY1030-49	9GD 120 670-001
		7.526.328.000.0	2SD 964 169-111			043 37596	9FF 090 500-001
		7.526.329.000.0	2SD 964 169-117			433 7596EY1030-49	9FF 090 500-001
		7.526.329.000.0	2SA 964 169-091			043 40118	2JA 003 231-001
		7.526.330.000.0	2SA 965 039-081			434 01118EC1024-49	2JA 003 231-001
		7.526.330.000.0	2SA 965 039-087			043 49205/10	2SE 003 184-011
		7.526.332.000.0	2BE 343 130-777			043 49205/10	2SE 003 184-017
		7.526.333.000.0	2BE 343 130-787			043 49207/10	2SD 003 184-041
		7.526.334.000.0	2SD 343 130-797			043 49207/10	2SD 003 184-047
		7.526.335.000.0	2SD 343 130-807			043 65082	2BE 003 014-251
		7.526.336.000.0	2SA 001 259-751			436 5082KZ1212-49	2BE 003 014-251
		7.526.336.000.0	2SA 001 259-757			436 5082KZ1212-49	2BE 003 014-257
		7.526.336.004.0	9EL 135 266-001			043 65083	9EL 115 003-055
		7.534.101.000	2PF 001 648-171			436 5089EY1212-49	9EL 115 003-055
		7 534 116 000	2PF 001 650-001			043 70259	9EL 118 701-001
		7 534 118 000	2PS 002 727-001			437 0259EY1075-49	9EL 118 701-001
		7 534 118 000	2PS 004 361-001			043 70260	9EL 118 700-001
		7 534 118 000	2PS 004 361-007			437 0260EY1075-49	9EL 118 700-001
		7.534.128.000	2PF 001 259-631			043 84138	9GH 126 647-011
		7 534 134 000	2XS 005 020-001			438 4138EZ1101-49	2KA 003 389-061
		7 534 134 000	2XS 005 020-002			043 85089	2KA 003 389-062
		7.534.135.000	2XS 005 020-003			043 85089	2KA 003 389-068
		7 534 138 000	2SA 001 240-331			438 5089KZ	2KA 003 389-062
		7.534.140.000	2SA 001 634-121			438 5089KZ	2KA 003 389-068
		7.534.153.000	2PG 003 057-011			438 5089KZ1101-49	2KA 003 389-061
		7.534.153.000	2ZR 003 236-051			438 5089KZ1101-49	2KA 003 389-062
		7.534.160.000	2ZR 003 236-057			438 5089KZ1101-49	2KA 003 389-068
		7.534.160.000	2XS 005 020-017			438 5089KZ1101-49	2KA 003 389-068
		7.534.191.000	2XS 005 020-017			043 89584	2BE 002 776-251
		7.534.191.000	2PS 006 717-057			438 9584KZ1065-49	2BE 002 776-257
		7.534.204.000.0	2PS 964 295-051			438 9584KZ1065-49	2BE 002 776-261
		7.534.204.000.0	2PS 964 295-057			043 89586	2BE 002 776-267
		7.534.205.000.0	2PT 965 039-171			438 9586KZ1065-49	2BE 002 776-267
		7.534.205.000.0	2PT 965 039-177			438 9586KZ1065-49	2BE 002 776-267
		7.542.110.000	2DA 001 240-341			043 89588	2SE 002 776-211
		7.544.111.000	2KA 003 389-001			438 9588KZ1065-49	2SE 002 776-211
		7.544.120.000.0	2KA 004 331-061			438 9588KZ1065-49	2SE 002 776-211
		7.544.120.000.0	2KA 004 331-067			043 89588	2SE 002 776-211
		7.544.305.000	2KA 001 378-001			438 9588KZ1065-49	2SE 002 776-217
		7.544.306.000.0	2KA 998 523-001			438 9588KZ1065-49	2SE 002 776-217
		7.544.306.000.0	2KA 998 523-007			043 89594	2SD 002 776-241
		7.551.060.000.0	2JA 003 231-001			438 9594KZ1065-49	2SD 002 776-241
		7.551.063.000.0	2JA 006 487-261			438 9594KZ1065-49	2SD 002 776-241
		7.552.015.000	2JA 003 232-001			438 9594KZ1065-49	2SD 002 776-241
		7.552.015.000	2JA 003 232-011			043 90876	9EL 134 739-001
		7.552.028.000.0	2JA 996 038-001			043 90876EY1065-49	9EL 134 739-001
		7.552.036.000	2JA 006 447-251			043 90877	9EL 134 741-021
		7.552.038.000.0	2JA 001 357-002			043 90877EY1065-49	9EL 134 741-021
		7.571.300.000	1GB 996 080-011			043 90878	9EL 137 308-001
		7.581.174.000.0	8GA 006 841-241			438 9588KZ1065-49	9EL 137 308-001
		7.581.175.000.0	8GP 003 594-121			043 90879EY1065-49	9EL 137 308-001
		7.581.176.000.0	8GA 002 071-131			043 90879	9EL 134 742-021
		7.581.178.000.0	8GH 007 157-241			439 0879EY	9EL 134 742-021
		7.582.010.000.0	8GS 007 949-101			438 9588KZ1065-49	9EL 134 742-021
		7.582.011.000.0	8GD 002 078-121			043 91462	1GA 006 991-021
		7.582.012.000.0	8GH 008 358-241			043 91462	1GA 006 991-021
		7 711 119 000	3AF 003 399-071			044 03158	2KA 001 378-041
		7.711.119.000.0	3AF 003 399-077			044 03159	2SD 002 776-241
		7.711.120.000.0	3AF 003 399-061			044 03159	2SD 002 776-241
		8.689.018.000	8RA 002 016-121			044 03159	2SE 002 776-211
		8.689.025.000.0	8RA 002 010-011			044 03161	2SE 002 776-211
		8.689.032.000	8RA 002 020-001				9EL 137 308-001



Manufacturer's no. / Hella no.

Cross-Reference

Klößckner-Humboldt-Deutz	Hella	Klößckner-Humboldt-Deutz	Hella	Kramer	Hella	Krone	Hella
044 03162	9EL 137 307-001	CC6 262010	2PF 003 057-041	56091	2SK 003 567-321	200808100	9EL 859 020-101
044 11937.4	1GA 007 506-001	CC6 262011	2SA 003 057-021	56092	2SK 003 567-331	200810070	8HG 006 294-101
044 11937.4	1GA 007 506-002	CC6 269004	9EL 116 907-001	56093	2SL 003 567-311	200812300	2PC 964 295-121
044 11937.4	1GA 007 506-007	CC6 269005	9EL 117 330-001	56095	2TF 001 259-761	200812300	2PC 964 295-127
044 11937.4	1GA 007 506-081	CC6 269006	9EL 117 330-011	56096	2XS 005 020-001	200812340	2SB 009 362-041
044 13298	8RA 004 412-001	D04 413298	8RA 004 412-021	56096	2XS 005 020-002	200812350	2BA 009 001-001
044 13298	8RA 004 412-021	D11 25492720	2BE 003 018-011	56096	2XS 005 020-003	200812350	2BA 009 001-007
044 13298EY2005-49	8RA 004 412-021	D11 55492210	2SB 003 018-031	56097	2XS 005 020-011	200812350	2BA 009 001-001
044 13298X	8RA 004 412-001			56097	2XS 005 020-017	200812350	2BA 009 001-007
044 14773	2RL 006 846-001			56098	2XS 005 020-021	200812360	8GA 006 841-121
044 19284.4	9XD 990 284-001			56100	2XS 003 168-071	200912350	2BA 009 001-001
044 24195.4	1GA 007 506-001			56103	2XS 950 071-031	200912350	2BA 009 001-007
044 24195.4	1GA 007 506-002			56104	2XS 955 031-001	270000940	8RA 003 326-001
044 24195.4	1GA 007 506-007			56112	ZRR 003 236-051	270000940	8RA 003 326-002
044 24195.4	1GA 007 506-001			56112	ZRR 003 236-057	270058860	2BE 343 130-657
044 25599.4	1GA 007 506-001			56115	2PS 006 717-031	270058880	2BE 343 130-667
044 25599.4	1GA 007 506-002			56115	2PS 006 717-032	270058890	1GA 996 161-101
044 25599.4	1GA 007 506-007			56115	2PS 006 717-037	270065410	1GA 996 161-351
044 26316	2JA 006 487-347			56118	2PF 006 679-007	270069770	8RA 002 016-111
044 34891	1GB 006 213-111			56118	8GH 002 090-251	270076520	1GA 996 461-797
044 34891	1GB 006 213-117			56118	8GH 002 090-253	270078190	1GA 996 461-787
044 34893	1LB 006 213-057			56120	8JA 001 925-001	0301554/0	4RD 933 332-041
044 34950	1GA 007 506-061			56201	2SA 006 717-001	0301853/0	2SB 001 259-261
044 34950	1GA 007 506-111			56201	2SA 006 717-007	0301854/0	8GM 002 091-131
044 39648	9EL 118 697-001			56249	8KW 701 235-033	3018541	8GM 002 091-131
044 50666	1GA 998 522-011			56263	8RA 003 326-001	0302534/0	2SK 003 567-331
062 17169	2BA 002 324-011			56263	8RA 003 326-002	0302535/0	2SK 003 567-321
062 17170	2BA 002 324-021			56266	8RL 002 009-021	0302642/0	8HG 006 294-021
062 17171	2BA 003 014-011			56273	9BG 101 230-001	0302657/0	8KW 701 235-033
062 17172	2BA 001 227-201			56297	9EL 109 139-001	0302658/0	9GP 003 995-801
062 17180	9EL 110 918-001			56305	9EL 112 741-001	0302677/0	2SW 003 014-131
062 17182	9EL 110 536-001			56310	9EL 113 324-001	0302680/0	2TM 003 057-031
062 17218	2BE 003 347-001			56314	9EL 118 701-001	0302690/0	8JA 007 158-001
062 57809	2JA 001 330-001			56316	2BM 006 692-011	0302702/0	2KA 001 386-281
062 57809	2JA 001 330-007			56316	2BM 006 692-017	0302917/0	2SB 003 014-151
626 2009	2BA 003 022-021			56316	9EL 122 772-001	3018541	8JD 008 151-011
626 2011	2SA 003 057-021			56317	2BM 006 692-021	0303463/0	8JA 003 526-001
626 2012	1TA 003 570-101			56317	2BM 006 692-027	0303601/0	8GP 938 026-001
626 2032	2ZR 002 589-011			56319	9EL 950 315-001	0303858/0	8GP 938 026-001
626 3052	8JA 003 526-001			56320	9EL 950 315-031	0303864/0	8GP 003 594-121
626 9006	9EL 117 330-011			56338	2KA 001 386-231	3109.7008	9GD 157 876-007
626 9007	1TA 122 718-001			56354	9EL 101 353-001	4500.7017	2JA 010 838-017
062 77521	2PF 003 014-071			56361	2SD 001 685-231	4501.7063	2TM 008 645-957
062 77522	2SA 003 014-051			56362	2SD 001 685-232	500924579	2TM 008 645-067
065 15208	2PG 003 057-011			56366	2AA 001 200-031	500924580	8JA 002 963-031
065 15208	2SA 003 057-021			56369	ZRR 002 694-001	500944015	8JB 001 283-001
065 26511	ZRR 003 014-091			56369	8RA 002 020-001	500944067	ZRR 003 236-051
065 27091	2SB 003 014-151			56369	8RA 002 020-002	500944070	8GH 002 090-251
065 32698	9EL 119 544-111			56401	8RA 002 020-003	500944104	8GD 002 078-241
065 38035	2XS 005 020-011			56402	2KA 003 389-001	500944110	8RA 003 326-031
065 38035	2XS 005 020-017			56428	9EL 119 544-111	500944105	8RA 003 326-047
065 38036	2KA 001 386-231			56429	2AA 001 204-001	500944107	2SD 003 326-051
680 966	9EL 087 769-001			56430	2AA 001 204-011	505805106	8RA 003 326-051
710 1621301	8JA 001 909-001			56431	9EL 150 965-001	505806987	2RL 008 060-111
089-004120-2.031	1SO 001 430-011			56437	9EL 150 966-001	505810617	1GB 996 102-101
089-004126-2.031	9DR 090 206-001			56450	9ES 106 588-001	505811907	8HG 006 294-021
089-004140-1.110	2BA 003 014-111			56454	2TM 003 748-011	505811909	2PG 003 748-151
089-004147-1.002	2TM 003 057-031			56454	2PS 004 361-001	505812980	2PS 003 748-161
089-004148-1.010	2AA 001 200-011			56454	2PS 004 361-007	505814052	2XS 003 748-177
089-004148-1.010	2AA 001 200-012			56465	9GP 003 995-801	505814249	2PS 008 078-007
0.900.1162.7	8GS 009 028-021			56473	8HG 002 365-001	505815081	9EL 154 637-001
0.900.1267.7	9GP 859 115-001			56474	2KA 001 386-281	505816277	1ND 005 700-061
0.900.1267.8	9MM 858 114-001			56479	9EL 118 700-001	505816277	9GD 157 876-007
0.900.1267.9	9EL 859 020-001			56481	2TJ 003 168-151	505816704	8RA 003 326-017
0.900.1268.0	8GH 002 089-133			56482	8HG 006 294-021	505822220	2TM 008 645-067
0.900.1268.1	9DX 860 438-001			56482	1NE 002 537-301	505822220	2TM 008 645-957
091 200007-7826	1GA 005 060-001			56486	9EL 856 416-001	505822445	2TM 008 645-067
091-207002-1.935	9EL 110 542-001			56497	2VA 006 040-071	505824445	5DS 009 552-011
091 207002-1.936	9EL 110 540-001			56499	2VA 006 040-077	505870338	2TM 963 639-317
091 207002-4631	9EL 120 224-001			56508	9EL 136 819-031	506000000	9GT 146 757-007
000 9739002	9EL 043 137-001			56511	8HG 006 294-011	515025360	2JA 010 838-017
000 9739003	8XS 113 389-001			56513	8GP 003 594-121	515025952	1GM 996 136-101
000 9740211	2SW 003 014-131			56513	1GA 005 060-001	515032148	1GM 996 136-191
000 9740212	2SD 003 182-061			56514	1GA 006 876-001	5327089/0	2DA 343 106-011
000 9740212	2SD 003 182-067			56516	2JA 005 590-001	5327094/0	2SD 001 685-232
000 9740213	2SD 003 182-051			56518	9GD 858 086-001	5327094/0	2NE 003 236-001
000 9740213	2SD 003 182-057			56560	1GA 006 875-001	5327094/0	2NE 003 236-008
000 9740400	1SO 001 430-011			56569	2PF 001 259-631	5327095/0	2ZR 003 236-051
000 9740600	2SB 003 018-031			58141	9EL 136 825-011	5327095/0	2ZR 003 236-057
000 9741013	2BE 001 278-011			58141	2XS 955 260-001	5327096/0	2KA 998 523-007
000 9741022	2BA 002 652-111			58454	2XS 955 260-007	5327282/0	2SD 001 685-232
000 9741022	2BA 002 652-117			58458	1GA 006 876-001	5327283/0	2SD 001 685-232
000 9741023	2BA 002 652-121			58458	2PS 003 748-121	5327284/0	2KA 998 523-001
000 9741023	2BA 002 652-127			603 332 02 40	2PS 003 748-127	5327284/0	2KA 998 523-007
000 9741028	2BA 003 014-111			000 80080908	8HG 006 294-021	5327355/0	2SD 001 685-232
000 9741104	2TJ 001 633-211			9709229	9EL 136 833-011	5336608/0	2VB 004 887-011
000 9741500	2AA 001 200-021			000 992 43 04	1GD 996 018-541	5336610/0	2SD 001 685-231
000 9741500	2AA 001 200-023				9KS 075 307-001	5336610/0	2SD 001 685-232
000 9741700	2XW 003 146-001					5357550/0	2XS 008 078-007
000 9746015	9EL 087 769-001					5357551-0	2XS 008 078-007
000 9746024	9EL 052 476-001					550000582	2TM 008 645-087
000 9746031	9EL 088 525-001					550000582	2TM 008 645-937
000 9746034	9EL 110 540-001					550014672	9EL 113 324-001
000 9746035	9EL 115 003-011					550015113	8HG 160 409-002
000 9746036	9EL 118 614-011					5800123	2SE 001 685-221
000 9746038	9EL 110 536-011					5800123/0	2SE 001 685-227
000 9747905	9FF 090 500-001					5800123/0	2SE 001 685-221
000 9748101	9ES 019 205-001					5800809/0	2SE 001 685-227
000 9748201	9DR 090 206-001					5801411	9GP 003 995-801
000 9748202	9DR 090 206-001					5801411/0	2KA 001 378-001
000 9748303	9GD 023 639-001					5801434	2KA 001 378-001
000 9748305	9GD 024 183-001					5801434/0	2SL 003 567-311
000 9748315	9GD 120 670-001					5802071	2SL 003 567-311
000 9748403	9KS 075 139-001					5802071/0	2SD 001 685-211
000 9748405	9KS 075 307-001					5802071/0	2SD 001 685-211
000 9940112	8RA 002 015-021					5802072/0	2SD 001 685-218
AH7 651	2AB 001 208-001						2KA 001 386-281

Manufacturer's no. / Hella no.

Cross-Reference



Krone	Hella	Krone	Hella	Leart	Hella	Liebherr	Hella
5803616/0	2PS 004 361-001	0924766/0	8GH 002 473-151	37.519.000	2VD 008 204-171	1 028 886 0	5DV 008 856-007
5803616/0	2PS 004 361-007	9247670	8GH 008 357-001	37.526.000	2VP 008 204-101	1 029 199 6	1GA 996 161-131
5803625/0	2PF 001 259-631	0924788/0	8HG 006 294-031	37.526.028	9EL 152 884-001	1 029 335 5	1K0 008 191-041
5803642/0	2SE 001 685-201	0924788/0	8HG 006 294-131	37.529.000	2VD 008 204-111	1 029 335 5	1K0 008 191-047
5804155/0	1G4 003 470-031	0924789/0	8HG 006 294-041	37.534.000	2VP 008 204-081	1 029 721 4	1GA 996 161-581
5805106/1	2RL 008 060-111	9305004	2SD 001 699-061	37.537.000	2VD 008 204-091	1 029 727 9	8HG 005 436-011
5805461/0	2KA 003 389-001	9305220	8GM 002 092-121	37.570.000	2VD 008 204-141	1 030 071 4	1GA 007 506-651
5806987/0	1GA 005 060-001	0942729/0	8RA 003 326-011	37.571.000	2VD 008 204-151	1 030 136 4	8GA 006 841-121
5806987/0	1GB 006 213-111	0942729/0	8RA 003 326-017	37.590.000	2VP 008 205-031	1 030 311 5	2BA 344 169-027
5806987/0	1GB 006 213-117	944 005	2TJ 001 633-211	37.591.000	2VP 008 205-031	1 033 046 1	1GA 998 534-541
5806987/1	1GB 996 102-101	0944005/0	2TJ 001 633-211	37.592.000	2VD 008 205-041	1 033 079 0	9GD 102 484-001
5807524/0	2PF 001 259-677	0944006/0	2SA 001 634-121	37.593.000	2VD 008 205-051	1 033 080 7	2VP 006 400-397
5808491/0	2SK 005 883-011	0944008/0	2TF 001 259-761	37.600.028	9EL 152 884-001	1 033 080 8	2VP 006 400-407
5808492/0	2SK 005 883-021	0944009/0	2BA 001 259-611	37.600.028	2VD 008 205-021	1 033 150 4	8GS 009 028-021
5808673/0	2PS 006 717-031	0944009/0	2BA 001 259-618	37.603.000	2VD 008 205-011	1 033 571 9	2JA 007 372-051
5808673/0	2PS 006 717-032	0944011/0	2XS 005 020-021	37.798.000	2VP 008 789-021	1 035 161 4	8JA 004 667-001
5808673/0	2PS 006 717-037	0944012/0	2XS 950 071-031	37.799.000	2VP 008 789-051	1 035 633 7	1GA 007 506-091
5809357/0	8RA 003 326-001	0944013/0	2NE 003 236-001	37.801.000	2VD 008 789-011	1 041 154 8	8HG 003 799-001
5809357/0	8RA 003 326-002	0944013/0	2NE 003 236-008	37.802.000	2VP 008 789-041	1 042 447 1	8HG 006 294-131
5809598/0	1NE 006 300-051	0944014/0	2ZR 004 542-001	37.803.000	2VP 008 789-071	1 042 490 4	2ZR 003 315-041
5809608/0	2PG 003 057-011	0944015/0	2ZR 003 236-051	38.440.000	2SK 003 567-321	1 045 091 4	2ZR 005 700-191
5809949	2JA 001 330-001	0944015/0	2ZR 003 236-057	38.441.000	2SL 003 567-311	1 048 993 8	2SD 343 390-407
5809949	2JA 001 330-007	0944016/0	2SE 001 699-071	38.443.000	2SK 003 567-331	1 048 993 8	2SD 343 390-407
5810252/0	2PG 004 361-011	0944017/0	2SD 001 699-511			1 053 076 7	2NE 344 200-091
5810252/0	2PG 004 361-017	0944018/0	2SD 001 699-061	1293370	1LG 007 660-031	1 053 076 7	2NE 344 200-097
5810617/0	8HG 006 294-021	0944019/0	2SD 001 693-011	1293371	1LG 007 660-041	1 054 126 2	2ZR 344 200-051
5810631/0	2PS 962 964-012	0944039/0	9GT 005 166-001	1299751	1FG 006 800-191	1 054 126 2	2ZR 344 200-057
5810631/0	2PS 962 964-018	0944040/0	9GT 074 132-001	1301368	2BA 005 481-011	1 054 126 3	2SD 344 100-101
5810631/0	9GD 963 281-001	0944046/0	8HG 002 240-001	1318143	9ES 147 313-011	1 054 327 7	9EL 174 995-001
5811455/0	2SA 006 717-001	0944047/0	8GM 002 240-011	1318145	9ES 147 314-011	1 065 149 4	6ZN 160 705-011
5811455/0	2SA 006 717-007	0944062/0	8GM 002 092-241	1328860	9BG 147 497-002	1 065 180 4	6ED 004 778-011
5811907/0	2PG 003 748-151	0944065/0	8GP 002 068-241	1328861	9BG 147 498-002	1 065 183 6	8HG 990 368-001
5811908/0	2PS 003 748-121	0944067/0	8GH 002 090-251	1444658	8RA 003 326-011	1 065 183 6	8HG 990 368-007
5811908/0	2PS 003 748-127	0944067/0	8GH 002 090-253	1444658	8RA 003 326-017	1 065 200 6	1GA 998 532-011
5811909/0	2PS 003 748-161	0944068/0	8GH 002 090-133	1636919	5DV 008 856-001	1 066 496 5	1GM 996 136-191
5811909/0	2PS 003 748-167	0944069/0	8GA 002 071-121	1636919	5DV 008 856-007	1 066 496 5	1GM 996 136-192
5811910/0	2KA 003 389-211	0944074/0	8GA 002 071-241	1636919	9GD 856 863-001	1 066 527 6	2BA 009 001-511
5811910/0	2KA 003 389-217	0944090/0	9EL 109 208-011	1636919		1 066 527 6	8XU 009 362-101
5812980/0	2PS 003 748-177	0944095/0	9EL 122 689-021	1636919		1 066 527 6	8RA 009 001-031
5814052/0	2XS 008 078-001	0944095/0	9EL 122 772-051	1636919		1 066 527 6	8RA 009 001-037
5814052/0	2XS 008 078-007	0944096/0	9EL 147 747-001	1636919		1 066 527 6	2SB 009 362-011
5814082/0	1GA 006 876-001	0944096/0	9EL 147 747-007	1636919		1 066 527 6	3AF 003 399-061
5814098/0	2VP 007 907-031	0944100/0	9EL 950 315-001	1636919		1 066 527 6	2BA 001 416-021
5814098/0	2VP 007 907-037	0944101/0	9EL 950 315-031	1636919		1 066 527 6	2BA 009 001-107
5814098/0	2VP 007 907-041	0944104/0	8RA 003 326-031	1636919		1 066 527 6	9XD 161 119-017
5814098/0	2VP 007 907-047	0944105/0	8RA 003 326-041	1636919		1 066 527 6	1GA 996 188-001
5814249/0	9EL 154 637-001	0944105/0	8RA 003 326-047	1636919		1 066 527 6	9HD 155 239-001
5814415/0	2PG 008 434-001	0944106/0	8RA 003 326-051	1636919		1 066 527 6	9AH 254 228-012
5815081/0	1ND 005 700-061	0944107/0	8RA 002 014-401	1636919		1 066 527 6	9AH 254 228-017
5815436/0	1GA 007 506-001	0944107/0	8RA 002 014-402	1636919		1 066 527 6	9AH 165 968-001
5815436/0	1GA 007 506-002	0944108/0	8RA 002 016-101	1636919		1 066 527 6	9XS 124 218-027
5815436/0	1GA 007 506-007	0944110/0	8RA 002 016-121	1636919		1 066 527 6	9NS 152 922-007
5816277/0	9GD 157 876-007	0944114/0	8HG 002 240-021	1636919		1 066 527 6	8JD 156 151-807
5816704/0	8RA 003 326-011	0944115/0	8HG 002 240-031	1636919		1 066 527 6	2TA 344 169-077
5816704/0	8RA 003 326-017	0944131/0	8KW 701 235-033	1636919		1 066 527 6	2TA 344 169-077
6200749/0	8RA 002 014-091	0944159/0	9EL 113 324-001	1636919		1 066 527 6	2NE 344 169-067
6200891/0	9EL 131 420-011	0944178/0	2XS 955 031-001	1636919		1 066 527 6	2BN 344 169-097
6200892/0	9EL 131 420-001	0944705/0	2NE 001 423-011	1636919		1 066 527 6	2BN 344 169-107
6200894/0	9EL 119 544-001	0944977/0	2SD 001 685-231	1636919		1 066 527 6	2NE 344 169-117
0924502/0	2XS 005 020-011	0944977/0	2SD 001 685-232	1636919		1 066 527 6	2KA 003 389-211
0924502/0	2XS 005 020-017			1636919		1 066 527 6	2KA 003 389-217
0924522/0	2ZR 001 423-001			1636919		1 066 527 6	9EL 104 571-031
0924533/0	8RA 002 010-011			1636919		1 066 527 6	9EL 104 571-041
0924533/0	8RA 002 010-011			1636919		1 066 527 6	9EL 118 613-001
0924578/0	8HG 002 365-001			1636919		1 066 527 6	1TA 003 570-101
0924580/0	8JB 001 933-031			1636919		1 066 527 6	9EL 950 315-061
0924581/0	8JA 001 925-001			1636919		1 066 527 6	1GA 007 506-681
0924603/0	2SE 003 167-031			1636919		1 066 527 6	1JA 006 447-251
0924635/0	1GA 007 506-001			1636919		1 066 527 6	1GA 996 188-001
0924635/0	1GA 007 506-002			1636919		1 066 527 6	1XS 005 020-041
0924635/0	1GA 007 506-007			1636919		1 066 527 6	2XS 005 020-047
0924635/0	1GA 007 506-011			1636919		1 066 527 6	2XA 008 221-021
0924635/0	1GA 007 506-012			1636919		1 066 527 6	2XA 008 221-027
0924635/0	1GA 007 506-001			1636919		1 066 527 6	1GM 996 136-241
0924635/0	1GA 007 506-002			1636919		1 066 527 6	2TM 003 748-011
0924635/0	1GA 007 506-007			1636919		1 066 527 6	2PF 959 570-411
0924636/0	2BE 003 347-001			1636919		1 066 527 6	2PF 959 570-417
0924636/0	2BE 003 347-001			1636919		1 066 527 6	2PS 003 057-051
0924638/0	2RL 006 846-001			1636919		1 066 527 6	2PS 003 057-057
0924639/0	2KA 001 386-231			1636919		1 066 527 6	9XR 854 840-001
0924639/0	2KA 998 523-001			1636919		1 066 527 6	2AB 004 532-031
0924639/0	2KA 998 523-007			1636919		1 066 527 6	9EL 146 491-001
0924669/0	2KA 003 389-061			1636919		1 066 527 6	2DA 001 240-341
0924669/0	2KA 003 389-062			1636919		1 066 527 6	1GS 005 760-221
0924669/0	2KA 003 389-068			1636919		1 066 527 6	1GD 122 772-001
0924672/0	2SK 003 567-331			1636919		1 066 527 6	9EL 122 772-001
0924673/0	2SK 003 567-331			1636919		1 066 527 6	5 701 899 08
0924688/0	8GH 002 090-133			1636919		1 066 527 6	5 701 899 08
0924690/0	8GA 002 073-241			1636919		1 066 527 6	5 704 507 78
0924691/0	8GA 002 073-251			1636919		1 066 527 6	5 704 507 77
0924692/0	8GA 002 071-131			1636919		1 066 527 6	5 706 012 08
0924693/0	8GA 002 073-121			1636919		1 066 527 6	5 710 680 08
0924709/0	8GM 002 092-121			1636919		1 066 527 6	5 710 680 77
0924710/0	9BG 993 345-001			1636919		1 066 527 6	5 711 167 08
9247120	8GM 002 091-131		</				



Manufacturer's no. / Hella no.

Cross-Reference

Liebherr	Hella	Liebherr	Hella	Liebherr	Hella	Liebherr	Hella
6 000 117	8GM 002 091-131	6 070 131 01	8GA 002 073-241	6 071 122	2ZR 003 236-051	6 071 344 08	2BA 001 221-041
6 000 118	2SB 003 018-031	6 070 134 01	8GM 002 092-241	6 071 122	2ZR 003 236-057	607134608	2SK 003 567-321
6 000 167	8GM 002 091-251	6 070 140	8GP 002 068-121	6 071 122 08	2ZR 003 236-051	607134708	2SK 003 567-331
6 000 308	8GA 002 071-251	6 070 141	8GP 002 067-121	6 071 122 08	2ZR 003 236-057	6071349	2PF 001 647-031
6 000 312	1G8 002 340-011	6 070 142	8GA 002 071-121	6 071 123 08	2BA 002 324-011	6071349	2PF 001 647-037
6 000 316	8KW 701 235-033	6 070 146	8GD 002 088-131	6 071 123 14	2BA 002 324-011	6 071 349 08	2PF 001 647-031
6 000 322	2JA 003 231-001	6 070 154 01	8GA 002 074-241	6 071 124	2BA 002 324-021	6 071 349 08	2PF 001 647-037
6 000 332	2JA 003 231-001	6 070 164 01	8GH 002 090-133	6 071 124 08	2BA 002 324-021	6 071 349 77	2PF 001 647-031
6 000 731	2JA 001 330-031	6 070 165 01	8GH 002 090-251	6 071 124 14	2BA 002 324-021	6071351	2PF 001 647-037
6 000 758	2ZR 003 014-091	6 070 165 01	8GH 002 090-253	6 071 125 08	2BA 001 416-011	6071351	2XS 005 020-011
6 000 766	2XW 003 146-001	6 070 192 01	8GP 003 594-251	6 071 127	2BA 002 324-001	6071351	2XS 005 020-017
6 000 766	2XW 007 146-001	6 070 196 01	2JA 007 372-011	6 071 127 08	2BA 002 324-001	6 071 351 08	2XS 005 020-011
6 000 776	1G4 003 470-051	6 070 199 01	8GP 003 594-241	6 071 128 08	2JA 007 372-011	6 071 351 08	2XS 005 020-017
6 000 780	2XS 005 020-011	6 070 200 08	8GD 002 088-251	6 071 130	2SA 001 634-121	6071361	2JA 001 357-002
6 000 780	2XS 005 020-017	6 070 201	8GM 002 092-241	6 071 130 08	2SA 001 634-121	6 071 361 08	2JA 001 357-002
6 000 804	1GA 005 060-001	6 070 201 08	8GM 002 092-241	6 071 131 08	2SB 003 014-151	6071362	1G5 003 241-021
6 000 804	1GA 998 522-011	6 070 201 14	8GM 002 092-241	6 071 132 08	2ZR 001 423-001	6 071 362 08	1G5 003 241-021
6 000 864	8GJ 002 525-131	6 070 202 08	8GP 002 068-241	6 071 133 08	8RA 002 016-121	6 071 367 08	2SD 003 182-051
6 000 865	8GH 002 089-133	6 070 202 14	8GP 002 068-241	6 071 134	2TJ 001 633-211	6 071 367 08	2SD 003 182-057
6 000 866	8GD 002 078-121	6 070 203	8GP 002 067-241	6 071 134 08	2TJ 001 633-211	6 071 368 08	2SD 003 182-061
6 000 867	8GP 002 095-121	6 070 203 08	8GP 002 067-241	6 071 135 08	8RA 002 014-041	6 071 368 08	2SD 003 182-067
6 000 907	8RL 002 009-021	6 070 206 08	8GA 002 072-241	6 071 135 08	8RA 002 014-042	6 071 374	2XS 950 071-031
6 000 914	8GJ 002 525-281	6 070 211 08	8GH 002 090-251	6 071 136 08	2ZR 002 589-011	6 071 374 08	2XS 950 071-031
6 001 131	2XS 005 020-001	6 070 211 08	8GH 002 090-253	6 071 136 14	2ZR 002 589-011	6 071 374 77	2XS 950 071-031
6 001 131	2XS 005 020-002	6 070 211 14	8GH 002 090-251	6 071 137	2BE 002 582-031	6 071 381 01	2PS 006 717-031
6 001 131	2XS 005 020-003	6 070 211 14	8GH 002 090-253	6 071 137 08	2BE 002 582-031	6 071 381 01	2PS 006 717-032
6 001 131 08	2XS 005 020-001	6 070 213	8GA 002 073-121	6 071 141	2SB 001 240-311	6 071 381 01	2PS 006 717-037
6 001 131 08	2XS 005 020-002	6 070 214 08	8GA 002 071-241	6 071 142	1G8 002 340-001	6 071 383 01	2SB 003 014-151
6 001 131 08	2XS 005 020-003	6 070 216	8GP 002 066-241	6 071 142 08	1G4 003 470-051	6 071 384	8RA 004 412-011
6 001 150	2BE 003 182-091	6 070 216 08	8GP 002 066-241	6 071 143	2RL 006 846-011	6 071 384 01	2PG 006 717-021
6 001 151	2BE 003 182-101	6 070 216 14	8GP 002 066-241	6 071 143 08	2RL 006 846-011	6 071 384 01	2PG 006 717-027
6 001 152	2BM 001 318-001	6 070 217 08	8GA 002 073-241	6 071 144 01	2AA 001 200-031	6 071 387 01	2ZR 003 014-091
6 001 153	8JA 007 158-001	6 070 217 14	8GA 002 073-241	6 071 154 08	1G8 002 340-011	6 071 388 01	2SD 002 582-011
6 001 202	1G3 005 760-001	6 070 220	8GM 002 092-121	6 071 154 14	1G8 002 340-011	6 071 388 01	2SD 002 582-017
6 001 202	1G3 005 760-201	6 070 221 14	8GH 002 090-133	6 071 165 05	2PS 006 717-061	6 071 388 08	1G4 003 470-031
6 001 202	1G3 005 760-207	6 070 222 08	8GP 002 095-241	6 071 165 05	2PS 006 717-067	6 071 389 01	2SD 002 582-011
6 001 424	2BA 003 014-111	6 070 228 08	8GD 002 078-241	6 071 198 01	2RL 006 846-011	6 071 389 01	2SD 002 582-017
6 001 424	2BA 996 012-061	6 070 232 08	8GA 002 071-251	6 071 202	8RA 002 016-111	6 071 389 01	2SD 002 582-021
6 001 499	2BE 003 014-251	6 070 232 14	8GA 002 071-251	6 071 204	8RA 002 010-011	6 071 389 01	2SD 002 582-027
6 001 499	2BE 003 014-257	6 070 234	8GJ 002 525-251	6 071 213 08	2XS 003 168-081	6 071 389 08	2RL 006 846-011
6 001 539	2NE 001 423-011	6 070 234 08	8GJ 002 525-251	6 071 237	2BA 003 014-011	607139108	2XS 005 020-001
6 001 546	1GB 006 213-101	6 070 234 14	8GJ 002 525-251	6 071 237 08	2BA 003 014-011	607139108	2XS 005 020-002
6 001 546	1GB 006 213-107	6 070 237	8GH 002 089-251	6 071 238	2NE 003 236-001	607139108	2XS 005 020-003
6 001 670	2SB 003 014-151	6 070 237 08	8GH 002 089-253	6 071 238	2NE 003 236-008	607139208	1G3 005 760-011
6 001 722	8HG 006 294-051	6 070 237 08	8GH 002 089-251	6 071 238 08	2NE 003 236-001	607139301	2SK 003 567-331
6 001 920	8RA 002 014-081	6 070 237 08	8GH 002 089-253	6 071 238 08	2NE 003 236-008	607139401	2SK 003 567-321
6 001 963	8JB 004 777-001	6 070 237 14	8GH 002 089-251	6 071 239 08	1NE 006 300-011	607139408	2XS 005 020-121
6 001 963	8JB 004 777-002	6 070 237 14	8GH 002 089-253	6 071 243 08	2BA 001 227-201	607139601	2SD 006 040-031
6 002 161	8JA 001 909-001	6 070 240 14	8GH 002 089-133	6 071 251 01	2ST 003 014-141	607139601	2SD 006 040-037
6 002 519	2ZR 002 985-261	6 070 247 01	8GA 002 071-251	6 071 251 08	1FE 002 537-191	6 071 397 01	2SE 002 578-701
6 003 035	2SA 003 057-021	6 070 248 01	8GD 002 078-241	6 071 251 08	1FE 006 300-001	6 071 397 01	2SE 002 578-707
6 003 073	8JB 004 777-001	6 070 300 08	8GS 002 296-111	6 071 252 01	2XS 950 071-031	607139708	2DA 003 014-031
6 003 073	8JB 004 777-002	6 070 336 14	8GP 002 067-261	6 071 252 14	2KA 003 389-001	607139708	2DA 003 014-037
6 003 252	9EL 120 240-011	6 071 000	2BA 001 227-201	6 071 262 01	8RA 002 014-051	607139801	2SD 006 040-161
6 003 311	8JA 001 915-001	6 071 003	2BA 001 248-001	6 071 262 01	8RA 002 014-052	607139801	2SD 006 040-167
6 004 180	8JA 001 925-001	6 071 010 08	2AA 001 200-131	6 071 263 01	8RA 002 023-021	6 071 401 08	2VD 005 300-551
6 004 187	2BA 003 014-111	6 071 011 08	2AA 001 200-141	6 071 266 01	8RA 003 326-011	607140408	2PF 003 389-037
6 004 350	8RA 004 412-021	6 071 040	2XM 004 444-011	6 071 266 01	8RA 003 326-017	6 071 405 08	1LH 002 658-511
6 004 402	8GA 002 073-251	6 071 040 08	2XM 004 444-011	6 071 267 08	2SA 003 014-051	6 071 406 08	1LH 002 658-521
6 004 447	2BA 964 169-311	6 071 043	2PF 001 648-161	6 071 269 08	2PS 003 057-051	6 071 408 08	2VD 005 300-581
6 004 448	2ZR 964 169-031	6 071 043 08	2PF 001 648-161	6 071 269 08	2PS 003 057-057	607140908	2XS 003 168-071
6 004 448	2ZR 964 169-037	6 071 043 77	2PF 001 648-161	6 071 269 14	2PS 003 057-051	607141708	2SA 006 679-027
6 004 449	2SB 964 169-301	6 071 058 08	2SD 001 688-141	6 071 269 14	2PS 003 057-057	607141908	1G9 001 523-021
6 004 450	2SB 964 169-307	6 071 059	2BA 001 259-611	6 071 279 01	2XS 950 071-031	6 071 420 01	2SD 002 582-011
6 004 450	2BE 964 169-071	6 071 059	2BA 001 259-618	6 071 282 01	2KA 001 386-231	6 071 420 01	2SD 002 582-017
6 004 450	2BE 964 169-077	6 071 059 08	2BA 001 259-611	6 071 283 01	607142008	607142008	2ZR 003 014-091
6 004 451	2XS 950 071-031	6 071 059 08	2BA 001 259-618	6 071 292	2BM 002 652-031	6 071 421 01	2SD 002 582-021
6 004 453	2NE 964 169-021	6 071 060 8	2XW 003 146-001	6 071 292 08	2BM 002 652-031	6 071 421 01	2SD 002 582-027
6 004 453	2NE 964 169-027	6 071 062 08	2XW 003 146-001	6 071 293	2ZR 003 236-051	6 071 423 01	2PF 001 650-001
6 021 170 08	9XD 130 261-001	6 071 062 08	2XW 007 146-001	6 071 293	2ZR 003 236-057	6 071 425 08	1G3 005 760-021
6 022 040 08	8KW 701 235-033	6 071 065 01	2SD 001 685-211	6 071 295 08	2SA 003 236-041	6 071 427 08	2PS 006 717-031
6 023 345 08	9GT 963 129-001	6 071 065 01	2SD 001 685-218	6 071 295 08	2SA 003 236-047	6 071 427 08	2PS 006 717-032
6 027 09	1GA 998 522-011	6 071 066 01	2SE 001 685-201	6 071 295 08	2SA 003 236-048	6 071 427 08	2PS 006 717-037
6 027 385 01	9GT 963 129-001	6 071 068 08	2SE 003 167-031	6 071 296 08	2SA 003 236-041	6 071 439 08	1FE 006 300-001
6 050 029 08	8JA 001 925-001	6 071 069	8RA 003 503-001	6 071 296 08	2SA 003 236-047	6 071 441 08	2VD 007 323-031
6 050 034	8JA 001 909-011	6 071 069 01	8RA 002 010-011	6 071 296 08	2SA 003 236-048	6 071 442 08	2VP 007 323-021
6 050 034 08	8JA 001 909-011	6 071 069 08	2SD 003 167-021	6 071 297 08	2SA 001 259-751	6 071 443 08	8RA 002 016-111
6 050 049 08	8JA 002 263-031	6 071 070	2SD 003 167-011	6 071 297 08	2SA 001 259-757	6 071 444 08	2RL 006 846-011
6 050 056 08	8JA 001 930-001	6 071 070 08	2SD 003 167-011	6 071 298 08	2TM 003 057-031	6 071 445 08	1GA 006 876-001
6 050 056 14	8JA 001 930-001	6 071 076	2KA 003 168-021	6 071 300	2JA 001 330-001	6 071 451 08	2VD 007 323-041
6 050 059	8JA 001 909-011	6 071 076 08	2KA 003 168-021	6 071 300	2JA 001 330-007	6 071 457 08	2RL 006 846-111
6 050 059 08	8JA 001 909-011	6 071 078	2KA 003 389-061	6 071 300 08	2JA 001 330-001	6 071 458 08	1DL 005 600-097
6 050 059 14	8JA 001 909-001	6 071 078	2KA 003 389-062	6 071 300 08	2JA 001 330-007	6 071 459 08	1DL 005 600-107
6 050 083	8JA 001 925-001	6 071 078	2KA 003 389-068	6 071 305 08	1G8 002 340-001	6 071 460 01	8RA 002 016-101
6 050 083 14	8JA 001 925-001	6 071 078 0	2KA 003 389-061	6 0			

Manufacturer's no. / Hella no.

Cross-Reference



Liebherr	Hella	Liebherr	Hella	Liebherr	Hella	MAN	Hella
6 071 485 08	1KL 007 834-027	6200685	8GH 002 090-251	7 372 932	9EL 859 020-001	28 12510 3603 9	2ZR 003 236-057
6 071 486 08	1NL 007 834-017	6200685	8GH 002 090-253	7 403 320	2NE 996 012-021	28 125207 6066	2RL 008 060-011
6 071 487 08	1BL 007 834-007	6200697	8GA 002 073-121	7 406 908	9EL 854 912-001	28 12522 9085 9	9EL 147 747-001
6 071 488 08	2DA 003 236-031	6200821	1G8 002 340-011	7 408 151	8JA 001 921-102	28 12522 9085 9	9EL 147 747-007
6 071 488 08	2DA 003 236-037	6200860	2BA 001 277-021	7 412 253	1GA 007 506-011	28 12526 0604 71	2X5 005 020-011
6071489	2BA 003 014-111	6200861	2BA 001 277-011	7 412 253	1GA 007 506-012	28 12526 0604 71	2X5 005 020-011
6 071 491 08	1GA 998 522-011	6200862	2KA 001 389-101	7 412 253 03	1GA 007 506-011	28 12526 0605 61	2X5 950 071-031
6071493	8GA 002 083-251	6 200 907	8JA 003 526-001	7 412 253 03	1GA 007 506-012	28 22520 76036	2RL 008 060-111
6 071 493 14	8GA 002 083-251	6 200 915	8GA 002 073-241	7 615 832	8HG 002 240-021	28 22526 060201	2X5 955 031-001
6 071 494 08	2BM 006 692-011	6 200 918	2BA 002 652-101	7 617 452	9EL 856 416-001	33 25225 6001	2BM 008 355-001
6 071 494 08	2BM 006 692-017	6 200 918	2BA 002 652-101	7 618 722	8RA 002 014-031	33 25225 6001	2BM 008 355-001
607149414	8GS 002 296-111	6 200 919	2SD 002 582-011	7 618 722	8RA 002 014-032	33 25225 6002	2PS 003 057-051
6071495	8GH 002 473-151	6 200 919	2SD 002 582-011	7 622 572	8RA 003 326-031	33 25225 6002	2PS 003 057-057
6 071 495 08	2BM 006 692-021	6 200 920	2SD 002 582-021	7 622 573	8RA 003 326-041	33 25231.0001	9GT 137 236-007
6 071 495 08	2BM 006 692-027	6 200 920	2SD 002 582-027	7 622 573	8RA 003 326-047	36 25101.6000	1K0 008 191-041
6 071 496 08	2BM 008 355-001	6201058	8GP 002 095-241	7 623 693	2XW 007 146-001	36 25101.6000	1K0 008 191-047
6 071 496 08	2BM 008 355-007	6 201 140	8GJ 002 525-251	7 623 848	9EL 136 825-001	36 25101-6002	1BL 007 834-007
6 071 497 08	2TM 003 057-031	6 201 154	2JA 001 372-011	7 623 849	9EL 136 825-011	36 25101-6003	1K0 007 834-027
6 071 498 08	2BA 003 236-177	6201387	2BA 003 022-001	7 623 851	8HG 006 294-111	36 25102.6000	1N0 008 582-011
6 071 498 08	2BE 964 169-071	6201459	2SD 001 699-061	8 125 6	1GA 998 522-011	36 25102.6000	1N0 008 582-017
6 071 499 08	2BE 964 169-077	6 201 483	8GA 007 997-021	9 200 919	2SD 002 582-011	36 25102-6001	1NL 007 186-027
6 071 500 08	2XL 004 762-001	6 201 493	2SD 001 699-511	9 200 919	2SD 002 582-017	36 25102-6004	1NL 008 090-327
6 071 503 08	1GA 007 506-111	6 201 612	8GS 002 296-111	9 605 207	8RA 003 326-001	36 25103.6000	2ZR 008 221-051
6 071 505 08	1GA 006 991-021	6201940	2NE 003 315-011	9 605 207	8RA 003 326-002	36 25103.6000	2ZR 008 221-057
6 071 506 08	2VD 007 323-141	6 202 284	8JA 003 526-001	K02999990	8PA 007 732-003	36 25103-6003	2ZR 001 240-377
6 071 507 08	2VD 007 323-131	6 202 683	1GA 006 875-001	W 211 10	2XM 001 974-041	36 25109-0000	9HD 149 253-007
6 071 508 08	2VP 007 323-121	6 203 044	1GA 996 082-001	Wagnetti Marelli Hella			9XB 152 977-001
6 071 509 08	1GA 007 506-081	6 203 865	2JA 007 372-011	15.940.5810	6NM 007 282-661	36 25201-6010	2JA 004 531-011
6 071 511 08	1GA 007 506-121	6 204 592	3AF 003 399-061	36.470.6923	6NM 007 282-661	36 25201-6012	2JA 005 590-001
6 071 512 08	1GA 996 142-141	6 204 593	3AG 003 399-101	05.548.0009	1L8 003 060-691	36 25201-6013	2JA 003 231-001
6 071 513 08	1GA 996 142-151	6 204 631	8RA 003 734-101	05.554.0009	1L8 004 190-111	36 25202-6003	2AB 004 532-051
6 071 578 14	2SA 961 167-011	6 204 631 03	8RA 003 734-101	710 30 117 460 5	1LF 009 057-031	36 25202-6002	2AB 004 532-057
6 071 580 14	1GB 998 080-001	6 205 045	3AF 003 399-071	710 30 117 460 6	1LF 009 057-041	36 25209.0003	9XB 161 749-007
6 071 600 01	2SL 003 567-311	6 205 347	1GD 996 018-541	710305063003	1NO 009 594-011	36 25225 6000	2XA 008 221-021
6 071 605 01	2SA 006 717-001	6 301 918 01	8JA 003 526-001	710305063004	1NO 009 594-021	36 25225 6000	2XA 008 221-027
6 071 605 01	2SA 006 717-007	6505033	2BA 002 652-121	710 30 785 230 9	6NM 004 375-311	36 25225 6001	2NE 008 221-031
6 071 610 01	2XS 955 260-001	6505003	2BA 002 652-127	710 31 132 800 1	2BA 008 404-011	36 25225 6001	2NE 008 221-037
6 071 610 01	2XS 955 260-007	6 905 001	2SD 004 623-028	710 31 132 800 2	2BA 008 404-021	36 25225 6002	2DA 959 071-737
607200908	8HG 002 240-021	6 905 028	2XS 005 020-017	710 31 132 800 3	2BA 008 404-031	36 25225 6006	2DA 005 603-031
6 072 009 14	8HG 002 240-021	6 905 028	2XS 005 020-017	710 31 132 800 4	2BA 008 404-041	36 25225 6006	2DA 005 603-037
6072010	8HG 002 240-001	6 905 030	2PF 001 259-631	710 31 132 800 4	2BA 008 404-041	36 25225 6007	2SA 005 603-027
6 072 010 08	8HG 002 240-001	6 905 032	2BA 002 652-111	710 31 132 900 2	2BA 008 404-021	36 25225 6007	2SA 005 603-027
6 072 011	8HG 002 240-031	6 905 032	2BA 002 652-111	710 31 132 900 3	2BA 008 404-011	36 25225 6008	2SD 003 184-031
6 072 011 08	8HG 002 240-031	6 905 033	2BA 002 652-121	710 31 132 900 3	2BA 008 404-041	36 25225 6008	2SD 003 184-037
6 072 012 08	8HG 002 365-001	6 905 033	2BA 002 652-127	710 31 132 900 4	2BA 008 404-031	36 25225 6009	2SD 003 184-041
6 072 012 08	8HG 006 294-101	6 905 121	8GJ 002 525-281	710 31 133 000 1	2BA 008 404-021	36 25225 6009	2SD 003 184-047
6 072 012 14	8HG 002 365-001	6 905 206	8RA 003 326-011	710 31 133 000 2	2BA 008 404-011	36 25225 6015	2PS 009 128-017
6 072 017 08	9EL 854 912-001	6 905 206	8RA 003 326-017	710 31 133 000 5	2BA 008 404-041	36 25240.6000	2KA 005 049-011
6 072 022	9EL 074 484-011	6 905 207	8RA 003 326-001	711 30 523 090 1	2BA 008 404-031	36 25240.6000	2KA 005 049-017
6 072 023	9ES 015 675-001	6 905 207	8RA 003 326-002	711 30 523 090 6	9EL 135 007-001	36 25260.6000	2PF 008 221-011
607203508	9EL 092 435-011	6 905 284	2KA 998 523-001	711 30 523 091 6	9EL 141 606-011	36 25260.6000	2PF 008 221-017
6 072 038	9EL 110 736-001	6 905 284	2KA 998 523-007	711 30 523 091 7	9EL 141 605-011	36 25260.6002	2PF 003 563-151
607203814	9EL 110 736-001	6 905 284	8GA 002 073-121	711 30 523 291 1	2BA 004 257-021	36 25260.6004	2XS 008 479-051
6 072 039	9EL 110 737-001	6 905 325	8GA 002 071-131	711 30 523 291 2	2BA 004 257-011	36 25260.6004	2XS 008 479-057
607204208	9EL 110 910-001	6 905 351	2RL 006 846-001	711 30 523 292 1	9EL 150 988-001	36 25260.6005	2XS 008 479-041
6 072 055 14	9XS 027 639-001	6 905 359	2RL 006 846-011	711 30 523 292 2	9EL 150 987-001	36 25260.6006	2XS 008 479-047
607206008	9EL 110 918-001	6 905 359	2RL 006 846-011	711 30 523 292 4	9EL 150 868-001	36 25260.6006	2PF 959 590-401
6 072 060 14	9EL 110 918-001	6 905 508	2SA 997 027-001	711 31 510 691 9	9EL 150 867-001	36 25260.6009	2PF 959 590-407
607206408	9EL 112 744-001	6 905 621	2BE 003 014-257	712 35 100 112 0	9EL 158 254-021	36 25260.6010	2PF 003 563-187
6 072 076	8HG 002 365-001	6 905 621	8GD 002 078-241	712 35 110 112 0	9EL 158 254-021	36 25260.6012	2PF 006 679-007
6072078	9DR 060 567-001	6 905 653	1GB 996 080-021	712 35 110 112 0	2BA 007 249-021	36 25260-6013	2PF 965 039-151
6 072 101 08	9EL 108 435-001	6 905 676	1GA 006 991-041	712 36 480 112 9	2BA 007 249-011	36 25260-6013	2PS 964 295-001
6 072 104 08	9EL 112 858-011	6 905 738	1GB 996 080-011	712 36 481 112 9	2BA 006 749-081	36 25320.6000	2PS 964 295-007
6 072 105 08	9EL 147 747-001	6 905 738	2JA 006 447-041	712 36 490 112 9	2BA 006 749-061	36 25320.6000	2BA 008 221-007
6 072 105 08	9EL 147 747-007	6 905 828	2JA 006 447-041	712 36 491 112 9	2BA 006 749-071	36 25320.6001	2BA 008 221-041
6 072 107 01	8HG 002 240-021	6 905 839	2VP 006 040-397	712 37 021 112 9	2BA 006 749-051	36 25320.6001	2BA 008 221-047
6 072 111 08	9EL 852 061-001	6 905 854	2VP 006 040-407	712 37 031 112 9	1NA 009 026-021	36 25320.6002	2BM 008 355-001
6 072 120 08	9GD 087 883-355	6 905 900	8GH 007 157-241	7 123 775 011 29	1NA 009 026-011	36 25320.6002	2BM 008 355-007
607212108	9GD 102 484-001	6 908 028 08	2XS 005 020-011	7 123 775 011 29	9EL 151 875-021	36 25320.6004	2BE 004 119-021
607212608	9EL 115 003-035	6 908 028 08	2XS 005 020-017	7140 296311701	9EL 151 876-021	36 25320-6005	2BA 005 603-117
6 072 127 08	1GB 132 293-011	6 930 298 14	2NE 001 423-011	7140 29631801	9EL 131 651-031	36 25320.6006	2BM 008 355-011
6 072 135 01	8HG 006 294-011	6 931 489 14	2SD 001 685-231	7140 29781701	9EL 129 149-021	36 25323.0000	8XU 008 405-031
6 072 138 008	9EL 119 544-111	6 931 489 14	2SD 001 685-232	7140 29781801	9EL 129 149-021	36 25323.0000	8XU 008 405-037
6 072 138 08	9EL 119 544-111	693149014	2ZR 001 423-001	7140 29781801	9EL 129 150-021	36 25323.0001	8XU 008 405-001
6 072 164 08	9GH 096 532-001	693149214	8GA 006 841-241	714 09 819 017 7	1NO 270 204-051	36 25323.0001	8RA 008 405-007
6 072 166 08	8HG 002 240-011	6 931 650 14	9GH 993 984-001	714 09 819 017 8	1NO 270 204-061	36 25323.0001	8KA 152 134-007
6 072 212 08	9BG 120 581-001	693173514	2XM 004 444-011	7140 98190230	2BA 002 939-171	36 25402.6000	9DT 143 133-007
607221508	1GS 119 738-001	6 931 939					



Manufacturer's no. / Hella no.

Cross-Reference

MAN	Hella	MAN	Hella	MAN	Hella	MAN	Hella
81.25103.6033	1G4 003 470-031	81.25229.0124	9EL 108 651-001	82.25103.6025	2ZR 003 315-041	90.81615.9135	2SD 001 685-218
81.25103.6039	2ZR 003 236-051	81.25229.0158	9EL 116 607-005	82.25103.6047	1G3 005 760-221	90.81615.9136	2SE 001 685-201
81.25103.6039	2ZR 003 236-057	81.25229.0244	9EL 122 772-001	82.25103.6047	1G3 005 760-227	90.81615.9144	2SD 001 680-281
81.25103.6041	2ZR 004 542-001	81.25229.0561	9EL 950 315-001	82.25140-0038	8HG 153 152-001	90.81615.9149	2PF 001 648-171
81.25103.6042	1G4 004 480-001	81.25229.0561	9EL 950 315-061	82.25100.6001	6NM 007 231-037	90.81615.9168	2JA 001 346-011
81.25103.6051	1G3 005 760-031	81.25229.0562	9EL 950 315-031	82.25201-6001	2JA 003 354-051	90.81615.9176	2KA 001 386-291
81.25103.6052	1FD 005 700-051	81.25229.0602	9EL 132 404-001	82.25206.6001	2PF 001 648-171	90.81615.9192	2BA 001 227-201
81.25103.6060	1GA 007 506-081	81.25229.6033	9EL 122 689-021	82.25207.6036	2RL 008 060-111	90.81615.9196	2AB 001 208-001
81.25103.7003	2ZR 001 240-351	81.25229.0617	9EL 132 215-011	82.25207.6037	2RL 008 061-111	90.81615.9213	2AA 001 200-131
81.25108.0015	1G3 135 211-011	81.25229.0618	9EL 132 215-001	82.25225-6111	2KA 001 378-041	90.81615.9223	2AA 001 200-001
81.25108.0016	9DF 112 247-001	81.25229.0623	9EL 114 401-041	82.25260-6015	2PF 003 057-001	90.81615.9249	2BA 001 240-301
81.25108.0020	1GA 998 525-001	81.25229.0713	9EL 856 416-001	82.25260-6017	2PG 003 057-011	90.81615.9251	2BA 001 240-301
81.25110.0066	9ES 122 221-007	81.25229.0784	9EL 119 544-111	82.25260-6019	2XS 005 020-021	90.81615.9285	2JA 001 335-011
81.25110.6005	9EL 101 353-001	81.25229.0785	9EL 119 544-001	82.25260.6020	2XS 955 031-001	90.81615.9297	2NE 003 030-151
81.25113.0030	1G8 132 233-011	81.25229.0786	9EL 119 544-021	82.25260-6027	2SB 001 259-261	90.81615.9298	2SA 001 240-331
81.25113.6011	9DF 112 246-001	81.25229.0859	9EL 147 747-001	82.25260-6028	2BE 001 259-061	90.81615.9299	2BA 001 240-301
81.25113.6016	1NE 138 555-011	81.25229.0859	9EL 147 747-007	82.25260-6029	2SA 997 027-001	90.89110.5336	8RA 002 016-111
81.25114.0065	9AG 120 516-005	81.25229.0962	9EL 862 141-001	82.25260.6032	2PG 004 361-011	90.89110.5357	8RA 002 023-011
81.25115.0019	9AL 120 514-001	81.25229.6002	9EL 855 097-001	82.25260-6032	2PG 004 361-017	90.89110.5358	8RA 002 023-021
81.25115.0020	9AL 120 515-001	81.25229.6005	9EL 122 772-001	82.25100.0001	4AZ 003 787-021	E81.25103-6060	1GA 007 506-081
81.25120.0014	9GH 152 654-007	81.25229.6024	9EL 122 772-051	83.25101.6014	1KB 003 177-061	N1.01102-5087	2NE 005 603-071
81.25140.0097	9XD 130 261-001	81.25229.6033	9EL 122 689-021	83.25114.0002	9AG 120 516-005	N1.01102-5087	2NE 005 603-077
81.25201.6075	2JA 003 232-011	81.25229.6035	9EL 122 689-051	83.25115.0001	9AL 120 514-001	N1.011025089	2SK 003 567-661
81.25201.6086	2JA 003 231-011	81.25229.6036	9EL 122 689-021	83.25115.0002	9AL 120 515-001	N1.01102-5092	2SK 003 567-651
81.25201.6087	2JA 001 346-011	81.25229.6053	9EL 134 658-001	83.25205.6501	2JA 001 364-001	N1.01102-5159	9EL 116 771-031
81.25201.6132	2JA 001 357-002	81.25229.66128	9EL 122 772-051	83.25240.6001	2KA 001 378-041	N1.01102-5195	2BA 005 603-011
81.25201.6192	2JA 003 354-001	81.25231.0020	9GD 052 710-019	83.25260.6504	2PF 959 570-401	N1.01102-5195	2BA 005 603-017
81.25201.7006	2AB 001 208-001	81.25231.0030	9GD 120 670-001	83.25260.6504	2PF 959 570-407	N1.01102-5201	2BA 001 259-611
81.25203.6016	2ZR 006 609-081	81.25231.0041	9GD 087 883-355	83.25260-6507	2PS 963 639-011	N1.01102-5201	2BA 001 259-618
81.25203.6016	2ZR 006 609-087	81.25236.0047	9FF 126 444-001	83.25260-6507	2PS 963 639-017	N1.01102-5215	9EL 120 201-001
81.25203.7003	2KA 001 386-291	81.25236.0047	9FF 135 906-021	83.25260-6507	2PF 001 638-011	N1.01102-5244	2PS 962 964-012
81.25205-6008	2JB 996 012-121	81.25238.6009	9MN 858 616-011	84.25101-6012	2ZR 002 694-001	N1.01102-5244	2PS 962 964-018
81.25207.6003	8HG 002 365-001	81.25250.7003	2SA 001 240-331	84.25102.6002	2NE 002 589-001	N1.01102-5245	9GT 963 129-001
81.25207.6066	2RL 008 060-011	81.25260.6001	2PF 001 648-171	84.25102.6008	2NE 003 236-001	N1.01102-5246	9GD 963 281-001
81.25210.0014	2AA 001 200-011	81.25260.6014	2XS 005 020-001	84.25102.6008	2NE 003 236-008	N1.01102-5258	2SB 005 603-137
81.25210.0014	2AA 001 200-012	81.25260.6014	2XS 005 020-002	84.25102.6010	1FD 005 700-051	N1.01102-5268	2SD 003 184-041
81.25210.0015	2AA 001 200-021	81.25260.6014	2XS 005 020-003	84.25103.6006	2ZR 003 236-311	N1.01102-5268	2SD 003 184-041
81.25210.0015	2AA 001 200-023	81.25260.6015	2PF 001 647-031	84.25103.6008	1GD 003 590-701	N1.01102-5270	2SD 003 184-031
81.25210.0027	2AA 001 200-041	81.25260.6015	2PF 001 647-037	84.25202.0001	2AB 001 208-001	N1.01102-5270	2SD 003 184-037
81.25210.0026	2AA 001 200-141	81.25260.6020	2SA 001 638-021	84.25215.0005	8RA 002 023-011	N1.01102-5316	9HD 155 239-001
81252100029	2AA 001 200-151	81.25260.6023	2SA 001 647-041	84.25215.0006	8RA 002 020-001	N1.01102-5322	1NL 007 834-017
81.25210.0089	2AA 001 200-011	81.25260.6029	2TJ 001 633-211	84.25215.0006	8RA 002 020-002	N1.01102-5329	1NL 007 836-041
81.25210.0089	2AA 001 200-012	81.25260.6047	2XS 005 020-017	84.25215.0006	8RA 002 020-003	N1.01102-5337	2SE 997 111-011
81.25225.6042	2SD 001 693-011	81.25260.6047	2XS 005 020-017	84.25225.6015	2SB 001 240-311	N1.01102-5338	2SE 997 111-021
81.25225.6045	2SA 001 240-331	81.25260.6056	2XS 950 071-031	84.25225.6017	2DA 003 236-031	N1.01102-5344	2TM 003 748-011
81.25225.6046	2DA 001 240-341	81.25260.6058	2PF 001 259-331	84.25225.6017	2DA 003 236-037	N1.01102-5346	2ZR 005 603-061
81.25225.6047	2BA 001 240-301	81.25260.6062	2XS 005 020-041	84.25225.6018	2SA 003 236-041	N1.01102-5346	2ZR 005 603-067
81.25225.6049	2KA 001 386-241	81.25260.6062	2XS 005 020-047	84.25225.6018	2SA 003 236-047	N1.01102-5464	2PF 961 167-001
81.25225.6061	2SE 001 699-071	81.25260.7009	2PF 001 638-011	84.25225.6018	2SA 003 236-048	N1.01102-5491	2XK 005 020-001
81.25225.6062	2SD 001 699-061	81.25301.6044	3AF 003 399-071	84.25225.6028	2KA 003 236-321	N1.01102-5491	2XK 005 020-002
81.25225.6083	2BA 001 227-201	81.25301.6045	3AF 003 399-061	84.25225.6061	2BA 004 525-001	N1.01102-5491	2XS 005 020-002
81.25225.6092	2SD 001 680-281	81.2531.0030	9GD 120 670-001	84.25229-0078	9EL 119 544-031	N1.01102-5532	2SA 001 259-751
81.25225.6097	2SE 001 680-291	81.25320.6049	2BA 002 324-011	84.66804-6005	2XM 004 444-011	N1.01102-5532	2SA 001 259-757
81.25225.6100	2KA 001 389-101	81.25320.6050	2BA 002 324-021	85.20001-1848	2SK 003 567-321	N1.01102-5546	9EL 120 240-011
81.25225.6103	2SE 003 167-031	81.25320.6058	2BA 003 022-021	85.20001-1849	9GP 003 995-801	N1.01102-9125	8KW 101 235-033
81.25225.6107	2BM 002 847-011	81.25320.6068	2BA 007 840-001	85.20001-2512	2SD 003 167-521	N1.01107-7023	2XA 959 790-401
81.25225.6108	2BM 002 847-021	81.25320.6071	2BA 003 236-021	85.25103.6001	1GA 006 876-001	N1.01107-7023	2XA 959 790-407
81.25225.6109	2KA 001 622-001	81.25320.6071	2BA 003 236-027	85.25103-6012	1G3 996 001-331	N1.01400-0293	9EL 091 749-011
81.25225.6111	2KA 001 378-041	81.25320.6073	2BA 007 839-001	85.96001.0005	9GT 074 132-001	N1.01400-6813	2PF 002 860-031
81.25225.6119	2KA 001 389-101	81.25320.6076	2BA 003 014-011	88.25101.6007	1K0 008 191-021	N1.01401-1914	2PS 963 639-011
81.25225.6121	2KA 003 010-007	81.25321.0022	9EL 116 907-001	88.25101.6007	1K0 008 191-027	N1.01401-1914	2PS 963 639-017
81.25225.6141	2VP 003 567-111	81.25321.0028	9EL 990 186-001	88.25101-6008	1NL 008 090-031	N1.01401-4174	8UD 156 150-807
81.25225.6151	2SL 003 567-311	81.25326.7016	2BA 001 240-301	88.25101-6008	1NL 008 090-037		
81.25225.6162	2SA 003 557-021	81.25407.6139	8KA 950 073-001	88.25101-6008	1NL 008 090-117		
81.25225.6172	2SL 003 567-311	81.25432.0139	8JB 850 434-011	88.25120.0001	9GH 152 654-007		
81.25225.6182	2KA 003 389-081	81.25435.0007	8JA 001 909-011	88.25120.0002	9GH 158 051-007		
81.25225.6198	2VP 003 567-121	81.25435.0040	8JA 001 915-001	88.25201.6033	2JA 001 331-011		
81.25225.6198	2VP 003 567-127	81.25435-007	8JA 001 909-011	88.25201.6064	2PF 001 259-677		
81.25225.6233	2KA 001 386-301	81.25435.0084	8JA 001 909-001	88.25210-6014	2PF 001 259-677		
81.25225.6259	2SD 003 167-531	81.25435.0088	8JA 001 914-011	88.25215.0001	8RA 008 405-001		
81.25225.6260	2SD 003 167-541	81.25435.0888	8JA 003 526-001	88.25215.0001	8RA 008 405-007		
81.25225.6402	2SD 001 685-231	81.25505.0501	6ED 708 919-001	88.25222-0004	9EL 110 014-001		
81.25225.6402	2SD 001 685-232	81.25901.0008	8GP 002 067-241	88.25225 6004	2BA 001 416-011		
81.25225.6403	2SE 001 685-221	81.25901.0029	8GP 002 096-061	88.25225 6005	2BA 001 416-021		
81.25225.6403	2SE 001 685-227	81.25901.0041	8GA 002 074-241	88.25225 6008	2BA 001 221-041		
81.25225.6404	2TF 001 259-761	81.25901.0043	8GP 002 095-241	88.25225.6012	2BA 001 221-031		
81.25225.6409	9EM 128 229-001	81.25901.0109	8GS 007 001-121	88.25225.6015	2KA 001 622-001		
81.25225.6413	2NE 003 236-301	81.25901.7052	8GA 00				

Manufacturer's no. / Hella no.

Cross-Reference



Massey-Ferguson	Hella	Mercedes-Benz Hella	Mercedes-Benz Hella	Mercedes-Benz Hella
3 708 059 M91	2BE 003 182-091	A 000 544 35 05	8RA 002 014-051	A 000 920 93 56
3 713 130 M91A	1GA 006 991-041	A 000 544 37 34	8RA 002 014-052	A 000 820 94 56
3 713 132 M91A	1GB 906 080-001	A 000 544 37 90	2KA 003 168-021	A 000 820 95 56
3 713 135 M1	1GB 006 213-111	A 000 544 39 05	9ES 015 675-001	A 000 820 96 56
3 713 135 M1	1GB 006 213-117	A 000 544 39 05	8RA 002 014-051	A 000 821 01 25
3 713 341 M1	8GJ 002 525-131	A 000 544 39 11	8RA 002 014-052	A 000 821 10 61
3714 399 M92	1GA 006 876-001	A 000 544 39 11	2XS 007 841-011	A 000 822 04 07
3778 456 M92	1GA 006 991-041	A 000 544 39 11	2XS 007 841-017	A 000 822 04 90
3 786 64M 91	1GA 996 161-101	A 000 544 40 11	2XS 007 841-021	A 000 822 27 20
3786 664 M91	1GA 996 161-101	A 000 544 40 11	2XS 007 841-027	A 000 822 30 88
3786 666 M91	1GA 996 161-121	A 000 544 41 05	8RA 002 016-111	A 000 822 31 88
3786 668 M91	1GA 996 161-291	A 000 544 42 05	8RA 003 326-001	A 000 822 33 97
3 786 668 M91	1GA 996 161-121	A 000 544 42 05	8RA 003 326-002	A 000 822 34 97
3 786 68M 91	1GA 996 161-291	A 000 544 43 90	9EL 141 612-001	A 000 822 35 88
3 786 68M 91	1GA 996 161-121	A 000 544 44 03	2SB 001 673-002	A 000 822 43 10
3788 157 M91	1GA 006 876-001	A 000 544 44 05	8RA 004 412-021	A 000 822 49 10
3 901 645 M1	2AA 001 201-011	A 000 544 45 05	8RA 002 016-111	A 000 822 50 10
4 199 21 M1	2BA 001 248-001	A 000 544 48 11	2PS 963 639-011	A 000 822 50 10
4 271 29M 91	1GB 006 213-111	A 000 544 48 11	2PS 963 639-011	A 000 822 75 10
4 271 29M 91	1GB 006 213-117	A 000 544 48 11	2PS 963 639-111	A 000 822 76 10
4 272 29M 91	1GA 996 161-121	A 000 544 56 03	2SD 001 686-101	A 000 822 77 10
4272 781 M91	1GA 006 876-001	A 000 544 56 30	2BA 003 236-021	A 000 822 80 20
4272 783 M91	1GA 006 876-001	A 000 544 56 30	2BA 003 236-027	A 000 822 81 20
4 272 81M 91	1GA 006 876-001	A 000 544 59 30	2BA 002 939-251	A 000 822 86 10
4272 829 M91	1GA 996 161-121	A 000 544 65 03	2ST 001 673-011	A 000 822 98 10
4 272 83M 91	1GA 006 876-001	A 000 544 65 92	9DR 060 567-001	A 000 825 00 03
4275 161 M91	1GA 996 161-121	A 000 544 65 93	9FF 111 606-021	A 000 825 00 14
4275 162 M91	1GA 996 161-121	A 000 544 70 03	2SE 001 699-071	A 000 825 02 03
4 275 61M 91	1GA 996 161-121	A 000 544 76 03	2SD 001 686-101	A 000 825 05 01
4 275 62M 91	1GA 996 161-121	A 000 544 77 02	9BG 121 740-001	A 000 825 06 03
4 276 83M 91	1GA 996 161-291	A 000 544 77 03	2SD 001 699-061	A 000 825 06 03
4276 983 M91	1GA 996 161-291	A 000 544 77 80	9GD 102 484-001	A 000 825 07 01
4 287 182 M1	1KO 008 191-011	A 000 544 78 03	2SE 001 699-071	A 000 825 08 01
4 287 182 M1	1KO 008 191-017	A 000 544 78 06	1NL 008 090-117	A 000 825 10 10
4 291 08M 92	1GA 007 506-081	A 000 544 79 80	9GD 102 484-001	A 000 825 36 10
4 291 09M 91	1GA 007 506-081	A 000 544 85 80	9GD 087 893-355	A 000 825 54 10
4 294 62M 91	2XS 003 168-071	A 000 544 87 80	9GD 120 670-001	A 000 825 60 01
4 295 56M 91	1GA 006 991-031	A 000 544 93 03	2SE 002 582-071	A 000 826 00 26
4 296 404 M2	1LL 008 193-117	A 000 544 99 03	2SD 001 699-061	A 000 826 04 44
4392669	1GA 006 875-001	A 000 545 07 81	9SG 703 965-007	A 000 826 04 47
4 490 077 0	1GA 998 532-011	A 000 545 13 47	1GA 998 522-011	A 000 826 04 56
4 506 004 5	1GS 003 241-021	A 000 545 21 15	2AA 001 200-011	A 000 826 05 56
4 506 004 5	1GS 003 241-071	A 000 580 01 97	2XM 004 444-001	A 000 826 07 14
4 508 470 0	1GA 998 522-011	A 000 583 09 53	2XW 003 146-001	A 000 826 08 14
5 017 952 M1	2RL 007 337-001	A 000 583 29 53	2XW 002 897-041	A 000 826 10 97
6 857 84	9ES 015 675-001	A 000 585 11 03	8XH 002 975-017	A 000 826 10 40
0 960 916 M91A	2KA 001 389-101	A 000 626 18 40	8RA 003 326-031	A 000 826 11 44
9 690 18 M1	2PF 001 634-101	A 000 657 01 23	8HG 096 531-007	A 000 826 11 40
9 692 36 M1	2BE 001 278-011	A 000 820 00 50	2JA 003 354-001	A 000 826 11 80
D 450 513 00	8HG 002 365-001	A 000 820 00 52	2AB 001 208-001	A 000 826 12 24
Mazda	Hella	A 000 820 02 21	2BA 003 110-011	A 000 826 13 41
1737-02-7	2JA 003 231-001	A 000 820 03 21	2BA 003 110-021	A 000 826 14 40
Mekra	Hella	A 000 820 04 57	2DA 959 071-737	A 000 826 14 41
20.6865.600	2BA 001 227-201	A 000 820 05 21	9EL 120 652-001	A 000 826 14 41
20.6868.700	2SW 003 014-131	A 000 820 06 21	2BA 003 411-001	A 000 826 14 41
20.6868.710	9EL 115 003-011	A 000 820 08 64	2SA 001 240-331	A 000 826 16 40
20.6960.700	8RA 004 412-001	A 000 820 09 09	9BG 121 587-031	A 000 826 16 40
20.6960.800	8RA 004 412-021	A 000 820 09 09	9BG 121 587-037	A 000 826 17 41
Mercedes-Benz Hella	Hella	A 000 820 12 60	2KA 001 378-041	A 000 826 17 41
A 000 000 00 01 72	8GH 007 643-121	A 000 820 12 64	2SA 001 240-331	A 000 826 18 40
A 000 000 57 17	8JA 003 526-001	A 000 820 14 64	2SA 001 638-021	A 000 826 18 40
A 000 000 65 69	2DA 003 236-331	A 000 820 14 67	2ZR 001 193-011	A 000 826 19 40
A 000 000 65 85	2NE 003 236-301	A 000 820 16 21	2BA 003 110-011	A 000 826 19 40
A 000 000 65 85	2NE 003 236-307	A 000 820 17 21	2BA 003 110-021	A 000 826 19 40
A 000 000 65 86	2ZR 003 236-311	A 000 820 17 68	2BA 001 240-301	A 000 826 21 10
A 000 000 68 20	2PF 006 679-007	A 000 820 18 60	2KA 001 388-051	A 000 826 24 47
A 000 000 68 21	2XS 004 237-291	A 000 820 19 60	2KA 001 389-101	A 000 826 26 10
A 000 000 68 22	2XS 004 237-301	A 000 820 20 56	2NE 001 423-011	A 000 826 27 10
A 000 000 68 28	2PF 001 647-031	A 000 820 22 67	2ZR 001 240-351	A 000 826 27 40
A 000 000 68 28	2PF 001 647-037	A 000 820 24 56	2ZR 004 542-001	A 000 826 28 40
A 000 000 68 85	2NE 003 236-301	A 000 820 24 68	2SB 001 673-002	A 000 826 28 40
A 000 000 68 85	2NE 003 236-307	A 000 820 25 68	2DA 001 240-341	A 000 826 28 97
A 000 000 68 86	2ZR 003 236-311	A 000 820 27 21	2BA 003 975-031	A 000 826 29 47
A 000 544 00 34	2KA 001 386-231	A 000 820 28 21	2BA 003 975-041	A 000 826 30 10
A 000 544 00 75	9EL 134 301-011	A 000 820 34 21	2BA 003 411-001	A 000 826 30 47
A 000 544 01 29	2PF 003 057-001	A 000 820 37 21	2BA 004 119-001	A 000 826 30 47
A 000 544 01 34	2KA 001 386-241	A 000 820 41 64	2SB 001 423-097	A 000 826 31 10
A 000 544 04 86	8JA 001 909-011	A 000 820 52 21	2BM 004 312-051	A 000 826 34 81
A 000 544 05 47	1GB 002 340-001	A 000 820 52 61	1S5 003 178-431	A 000 826 34 82
A 000 544 06 12	9EL 146 838-001	A 000 820 53 21	2BM 004 312-061	A 000 826 35 10
A 000 544 09 47	1GA 005 060-001	A 000 820 55 01	2JA 001 364-001	A 000 826 36 47
A 000 544 09 47	1GD 003 590-701	A 000 820 59 56	2NE 001 423-011	A 000 826 42 10
A 000 544 11 04	2NE 003 236-001	A 000 820 60 56	1NE 002 537-301	A 000 826 42 47
A 000 544 11 04	2NE 003 236-008	A 000 820 61 21	2BM 002 652-051	A 000 826 43 10
A 000 544 13 04	2NE 002 589-407	A 000 820 62 21	2BA 003 975-031	A 000 826 43 47
A 000 544 13 47	1GA 998 522-011	A 000 820 63 01	2JA 003 115-001	A 000 826 43 47
A 000 544 16 18	1ND 122 390-001	A 000 820 63 21	2BA 003 975-041	A 000 826 44 10
A 000 544 17 04	2NE 006 609-001	A 000 820 63 56	2ZR 003 030-171	A 000 826 46 10
A 000 544 17 04	2NE 006 609-007	A 000 820 68 21	9EL 129 615-011	A 000 826 47 10
A 000 544 18 04	2NE 003 236-301	A 000 820 69 21	9EL 129 614-011	A 000 826 54 90
A 000 544 18 04	2NE 003 236-307	A 000 820 71 10	6ZE 001 759-051	A 000 826 63 90
A 000 544 20 34	2KA 003 010-007	A 000 820 72 56	2NE 003 030-151	A 000 826 65 99
A 000 544 24 07	2ZR 003 236-051	A 000 820 74 21	9EL 120 652-001	A 000 826 66 24
A 000 544 24 07	2ZR 003 236-057	A 000 820 79 21	2BM 002 652-071	A 000 826 73 82
A 000 544 26 18	1GB 132 233-011	A 000 820 80 21	2BM 002 652-081	A 000 826 87 81
A 000 544 27 93	9FF 900 500-001	A 000 820 81 21	9EL 129 615-011	A 000 826 95 80
A 000 544 28 34	2KA 001 386-281	A 000 820 82 21	9EL 129 614-011	A 000 826 95 81
A 000 544 29 05	8RL 002 009-021	A 000 820 87 01	2JA 001 330-001	A 000 826 96 99
A 000 544 30 05	8RA 002 014-031	A 000 820 87 01	2JA 001 330-007	A 000 826 99 80
A 000 544 30 05	8RA 002 014-032	A 000 820 87 56	2ZR 003 030-171	A 000 827 07 31
A 000 544 30 34	2KA 001 386-231	A 000 820 89 20	2BA 001 227-211	A 000 827 08 31
A 000 544 32 05	8RL 002 009-021	A 000 820 90 56	2KA 003 389-061	A 000 993 00 98
A 000 544 32 07	2BA 003 236-171	A 000 820 90 56	2KA 003 389-062	A 000 997 32 86
A 000 544 32 34	2KA 001 386-281	A 000 820 90 56	2KA 003 389-068	A 000 997 80 81
A 000 544 33 07	2ZR 003 236-311	A 000 820 93 56	2XS 005 020-001	A 000 997 80 81
A 000 544 33 07	9KS 075 307-001	A 000 820 93 56	2XS 005 020-002	A 000 997 95 91
				2XS 005 020-003
				2TJ 001 633-211
				2TJ 003 168-151
				2PF 001 638-067
				8JA 001 909-001
				5DV 009 000-001
				2AA 001 200-151
				9EL 854 912-001
				2BA 001 234-261
				9DX 859 560-001
				9DX 859 625-001
				9GD 856 562-001
				9GD 856 863-001
				9DX 859 626-001
				9EL 116 907-001
				9EL 101 899-001
				9EL 101 900-001
				9EL 052 476-001
				9EL 110 737-001
				9EL 110 736-001
				9EL 109 440-002



Manufacturer's no. / Hella no.

Cross-Reference

Mercedes-Benz Hella		Mercedes-Benz Hella		Mercedes-Benz Hella		Mercedes-Benz Hella	
A 001 822 49 20	2BM 002 847-021	A 004 545 32 26	8JB 001 943-001	A 230 820 05 56	1N0 008 582-007	A 943 820 19 61	1LH 009 513-061
A 001 822 50 20	2BM 002 847-021	A 004 820 00 42	9MN 858 616-001	A 301 826 01 96	9GD 128 553-007	A 943 820 20 61	1LH 009 513-071
A 001 822 51 20	2BM 002 847-011	A 004 820 01 42	9MN 858 616-011	A 301 826 01 96	9GD 128 553-007	A 943 820 21 61	1LH 009 513-081
A 001 822 65 10	9EL 856 418-001	A 005 545 21 14	6ED 708 919-001	A 302 820 02 68	2SD 001 305-021	A 943 826 02 59	9AB 165 229-031
A 001 822 66 10	9EL 856 417-001	A 007 997 13 92	9XR 854 840-001	A 340 453 80 01	2SB 001 673-002	A 943 826 03 59	9AB 165 230-031
A 001 822 66 20	2BA 001 227-211	A 009 997 87 81	9GT 146 757-007	A 350 009 00 04	9EL 856 010-001	A 957 540 04 40	8HG 153 152-001
A 001 822 67 20	2BA 003 197-011	A 012 545 64 28	8JA 001 915-001	A 350 090 00 03	2AA 001 204-001	A 957 820 00 01	2JA 006 447-041
A 001 822 68 20	2BA 003 197-021	A 100 820 00 01	2JA 001 331-011	A 350 090 00 04	2AA 001 204-011	A 957 820 02 61	1DL 007 872-077
A 001 822 72 20	2BA 002 652-111	A 123 820 00 62	2KA 003 102-011	A 350 090 10 10	2ST 003 018-061	A 957 820 03 61	1DL 007 872-087
A 001 822 72 20	2BA 002 652-117	A 123 820 01 62	2KA 003 102-011	A 350 090 10 18	2SD 001 679-001	A 973 820 05 21	2BA 247 016-031
A 001 822 73 20	2BA 002 652-121	A 124 820 01 64	2VP 004 686-111	A 350 090 19 01	2SB 001 259-261	A 973 820 06 21	2BA 247 016-041
A 001 822 73 20	2BA 002 652-127	A 124 820 01 66	9EL 129 763-001	A 350 693 90 19	8RA 002 010-011	100 820 00 01	2JA 001 331-011
A 001 822 78 10	9EL 856 415-001	A 124 820 02 56	2KA 004 983-011	A 350 923 90 15	9EL 088 150-001	123 820 00 62	2KA 003 102-011
A 001 822 79 10	9EL 856 416-001	A 124 820 02 64	2VP 004 686-121	A 350 923 90 20	9EL 088 525-001	123 820 01 62	2KA 003 102-011
A 001 822 80 20	2BA 003 014-011	A 124 820 04 64	2VP 004 686-141	A 373 820 07 56	2SA 961 167-011	124 820 01 64	2VP 004 686-111
A 001 822 81 20	2BA 003 014-111	A 124 820 04 66	9EL 129 762-001	A 373 820 17 64	2SA 003 236-041	124 820 01 66	9EL 129 763-001
A 001 826 02 80	9GD 113 431-005	A 124 820 05 57	1LJ 007 219-371	A 373 820 17 64	2SA 003 236-047	124 820 02 56	2KA 004 983-011
A 001 826 02 81	9DF 117 504-007	A 124 820 06 57	1LJ 007 219-381	A 373 820 17 64	2SA 003 236-048	124 820 02 64	2VP 004 686-121
A 001 826 04 81	9DE 118 423-001	A 124 820 07 66	9EL 129 763-001	A 373 820 18 64	2DA 003 236-031	124 820 04 64	2VP 004 686-141
A 001 826 05 81	9DE 118 424-001	A 124 820 07 66	9EL 129 763-021	A 373 820 18 64	2DA 003 236-037	124 820 04 66	2VP 004 686-141
A 001 826 44 90	9EL 110 928-001	A 124 820 10 66	9EL 129 762-001	A 381 820 31 61	1LH 002 658-451	124 820 05 57	1LJ 007 219-371
A 001 826 47 90	9EL 101 353-001	A 124 820 10 66	9EL 129 762-031	A 381 820 32 61	1LH 002 658-461	124 820 06 57	1LJ 007 219-381
A 001 826 74 78	9DE 129 975-021	A 124 820 13 64	2VP 004 686-111	A 381 820 33 61	1LH 002 658-511	124 820 07 66	9EL 129 763-001
A 001 826 75 78	9DE 129 974-021	A 124 820 14 64	2VP 004 686-121	A 381 820 34 61	1LH 002 658-521	124 820 07 66	9EL 129 763-021
A 001 826 77 90	9EL 108 435-001	A 124 820 16 64	2VP 004 686-141	A 381 820 41 61	1LH 002 658-451	124 820 10 66	9EL 129 762-001
A 001 826 82 78	9DE 129 975-021	A 124 820 17 21	2BA 004 693-031	A 381 820 42 61	1LH 002 658-461	124 820 10 66	9EL 129 762-031
A 001 826 83 78	9DE 129 974-021	A 124 820 18 21	2BA 004 693-041	A 400 453 86 08	2BA 001 227-201	124 820 13 64	2VP 004 686-111
A 002 542 48 20	3AF 003 399-071	A 124 820 33 66	9EL 129 763-021	A 400 809 00 00 07	8GH 007 157-121	124 820 14 64	2VP 004 686-121
A 002 544 00 94	8GH 007 157-121	A 124 820 36 66	9EL 129 763-031	A 405 544 01 01	1DL 007 872-017	124 820 16 64	2VP 004 686-141
A 002 544 02 03	2SE 003 167-031	A 124 820 37 66	9EL 129 763-021	A 405 544 02 01	1DL 007 872-027	124 820 17 21	2BA 004 693-031
A 002 544 06 90	9EL 131 420-001	A 124 820 40 66	9EL 129 762-031	A 414 820 00 64	2VP 008 406-031	124 820 18 21	2BA 004 693-041
A 002 544 07 03	2VB 004 887-011	A 124 820 59 66	9AH 144 863-021	A 414 820 01 64	2VP 008 406-041	124 820 33 66	9EL 129 763-021
A 002 544 07 03	2VB 004 887-011	A 124 820 60 66	9AH 144 864-021	A 463 800 01 52	8JB 001 933-031	124 820 36 66	9EL 129 762-031
A 002 544 07 10	2VB 004 887-011	A 124 820 61 64	2VP 004 686-151	A 500 076 70 01	2AA 001 200-011	124 820 37 66	9EL 129 763-021
A 002 544 07 90	9EL 131 420-011	A 124 820 64 64	2VP 004 686-181	A 500 076 70 01	2AA 001 200-012	124 820 40 66	9EL 129 762-031
A 002 544 08 03	2VP 004 887-021	A 124 820 65 64	2VP 004 686-151	A 500 090 90 10	2ST 003 018-061	124 820 59 66	9AH 144 863-021
A 002 544 08 03	2VP 004 887-021	A 124 820 68 64	2VP 004 686-181	A 500 090 90 18	2SD 001 679-001	124 820 60 66	9AH 144 864-021
A 002 544 08 10	2VP 004 887-021	A 124 826 00 43	9EL 129 615-011	A 500 090 90 19	2SB 001 259-261	124 820 61 64	2VP 004 686-151
A 002 544 09 03	2VA 004 887-031	A 124 826 01 43	9EL 129 614-011	A 500 923 90 15	9EL 088 150-001	124 820 64 64	2VP 004 686-181
A 002 544 12 90	9EL 134 296-041	A 124 826 04 43	9EL 129 615-011	A 500 923 90 20	9EL 088 525-001	124 820 65 64	2VP 004 686-151
A 002 544 13 03	2SD 001 680-271	A 124 826 05 43	9EL 129 614-011	A 608 926 00 56	9EL 126 294-001	124 820 68 64	2VP 004 686-181
A 002 544 14 03	2SD 001 680-281	A 124 826 09 43	9EL 129 615-021	A 612 820 00 56	2KA 005 049-011	124 826 00 43	9EL 129 615-011
A 002 544 15 03	2SE 001 680-291	A 126 820 10 01	2JA 004 252-031	A 612 820 01 20	2KA 005 049-017	124 826 01 43	9EL 129 614-011
A 002 544 16 03	2SE 001 680-301	A 140 000 18 33	2PF 961 167-021	A 612 820 01 20	2BM 008 355-001	124 826 04 43	9EL 129 615-011
A 002 544 16 90	9EL 134 296-051	A 140 000 18 34	8GM 002 092-241	A 612 820 02 20	2BM 008 355-007	124 826 05 43	9EL 129 614-011
A 002 544 19 90	9EL 122 772-051	A 140 000 32 62	2BM 006 692-011	A 613 826 02 41	2PS 962 964-012	124 826 09 43	9EL 129 615-021
A 002 544 20 90	9EL 122 772-001	A 140 000 32 62	2BM 006 692-017	A 613 826 02 41	2PS 962 964-018	012 545 64 28	8JA 001 915-001
A 002 544 21 90	9EL 134 301-001	A 140 000 32 63	2BM 006 692-021	A 613 826 02 41	2PS 962 964-031	126 820 10 01	2JA 004 252-031
A 002 544 26 03	2VD 005 300-551	A 140 000 32 63	2BM 006 692-027	A 613 826 02 41	2PS 962 964-037	140 000 18 33	2PF 961 167-021
A 002 544 31 03	2SL 003 567-311	A 140 000 34 20	1DL 007 872-077	A 639 820 01 64	2SK 964 596-011	140 000 18 34	8GM 002 092-241
A 002 544 31 94	8GH 007 643-121	A 140 000 34 21	1DL 007 872-077	A 639 820 02 64	2SK 964 596-021	140 000 32 62	2BM 006 692-011
A 002 544 32 94	8GS 007 001-121	A 140 000 60 00	2JA 006 447-041	A 639 820 03 61	1LG 246 041-031	140 000 32 62	2BM 006 692-021
A 002 544 40 03	2VD 005 300-551	A 140 000 60 02	8GA 002 073-241	A 639 820 04 61	1LG 246 041-041	140 000 32 63	2BM 006 692-027
A 002 544 42 03	2VD 005 300-551	A 140 000 60 03	8GA 002 071-251	A 639 820 21 61	1LG 009 627-031	140 000 32 63	2BM 006 692-027
A 002 544 47 90	9EL 152 891-001	A 163 820 47 61	1LL 223 151-031	A 639 820 21 61	1LG 009 627-041	140 000 34 21	1DL 007 872-087
A 002 544 54 03	2VP 008 204-101	A 163 820 48 61	1LL 223 151-041	A 666 820 03 56	2PF 003 563-151	140 000 34 21	1DL 007 872-077
A 002 544 55 03	2VD 008 204-111	A 164 820 77 61	1LL 263 064-031	A 667 546 01 37	9GT 141 941-001	140 000 60 00	2JA 006 447-041
A 002 544 57 03	2SD 003 167-531	A 164 820 78 61	1LL 263 064-041	A 671 820 04 56	2KA 006 896-001	140 000 60 02	8GA 002 073-241
A 002 544 58 03	2SD 003 167-541	A 170 820 01 56	1NB 007 555-031	A 671 820 04 56	2KA 006 896-007	140 000 60 03	8GA 002 071-251
A 002 544 62 90	9EL 136 833-011	A 170 820 02 56	1NB 007 555-041	A 673 820 00 21	2BA 002 652-101	001 540 13 03	2VD 007 500-091
A 002 544 63 90	9EL 136 825-011	A 171 820 01 64	2VP 008 427-091	A 673 820 00 21	2BA 002 652-107	001 540 16 70	2VD 007 500-201
A 002 544 91 03	2VP 008 204-081	A 171 820 02 64	2VP 008 427-101	A 699 544 03 03	2SK 003 567-331	001 540 17 70	2VD 007 500-111
A 002 544 97 03	2VP 008 204-081	A 19 6 263698 02	2NE 002 589-001	A 699 544 04 03	2SK 003 567-321	001 540 20 70	2VD 007 500-221
A 002 544 98 03	2VD 008 204-091	A 202 826 01 43	2ZR 002 589-011	A 700 485 00 04	2BA 002 324-001	001 540 22 70	2VD 007 500-221
A 002 820 34 56	2PS 006 717-071	A 202 826 02 43	9EL 150 987-001	A 700 485 80 01	9EL 110 910-001	001 540 25 70	2VD 007 500-111
A 002 820 37 56	1NE 006 300-201	A 202 826 02 43	9EL 150 988-001	A 711 185 01 30	2SD 001 686-101	001 540 26 70	2VD 007 500-201
A 002 820 39 56	1FE 006 300-191	A 202 826 05 43	9EL 150 987-001	A 711 185 56 50	9EL 852 061-001	001 540 29 70	2VD 007 500-091
A 002 820 47 56	2PF 006 679-007	A 202 826 06 43	9EL 150 988-001	A 716 185 50 50	2KA 001 610-001	001 540 57 70	2VD 007 500-411
A 002 820 57 56	2XS 003 168-071	A 202 826 07 43	9EL 150 867-001	A 716 285 02 30	2SK 003 567-331	001 540 58 70	2VP 007 500-421
A 002 820 69 25	5DD 008 319-501	A 202 826 08 43	9EL 150 868-001	A 716 285 02 40	2SK 003 567-321	001 540 62 70	2VD 007 500-411
A 002 820 69 26	5DD 008 319-501	A 202 826 09 43	9EL 150 867-001	A 717 193 55 20	3AG 003 399-101	001 540 63 70	2VP 007 500-421
A 002 820 90 56	2DA 007 421-001	A 202 826 10 43	9EL 150 868-001	A 755 601 20 02 0	2AB 004 532-051	001 542 14 27	2AA 003 257-031
A 002 820 90 56	2DA 007 421-007	A 203 820 05 64	2VP 008 031-051	A 755 601 20 02 0	2AB 004 532-057	001 544 04 03	2SE 001 699-071
A 002 826 03 90	9EV 113 436-005	A 203 820 06 64	2VP 008 031-061	A 758 185 00 30	2BA 002 652-101	001 544 05 03	2SD 001 699-511
A 002 826 04 90	9ES 113 919-001	A 203 820 11 56	1NA 007 976-111	A 758 185 00 30	2BA 002 652-107	001 544 06 03	2SA 001 634-121
A 002 826 05 90	9ES 113 918-001	A 203 820 11 64	2VP 008 048-051	A 84 2070 9900-31	2BA 002 324-001	001 544 08 03	2SE 001 680-291
A 002 826 10 90	9ES 113 919-001	A 203 820 12 56	1NA 007 976-121	A 86 0533 9352-09	2BA 001 248-001	001 544 09 03	2SD 001 680-281
A 002 826 11 90	9ES 113 918-001	A 203 820 12 64	2VP 008 048-061	A 86 0535 9351-03	9EL 110 918-001	001 544 10 03	2SE 001 686-142
A 002 826 14 90	9EL 107 443-061	A 203 820 17 56	1NA 007 976-231				

Manufacturer's no. / Hella no.

Cross-Reference



Mercedes-Benz Hella		Mercedes-Benz Hella		Mercedes-Benz Hella		Mercedes-Benz Hella	
001 544 82 03	2SD 003 167-011	203 820 12 64	2VP 008 048-061	003 542 44 20	3AG 003 399-081	000 544 70 03	2SE 001 699-071
001 544 83 03	2SE 003 167-041	203 820 17 56	1NA 007 976-231	003 542 45 20	3AG 003 399-101	000 544 76 03	2SD 001 686-101
001 544 83 90	9EL 147 747-001	203 820 18 56	1NA 007 976-241	003 542 47 20	3AF 003 399-061	000 544 77 02	9BG 121 740-001
001 544 83 90	9EL 147 747-007	209 820 01 64	2VP 008 326-051	003 542 48 20	3AF 003 399-071	000 544 77 03	2SD 001 689-061
001 544 85 90	9EL 112 763-001	209 820 02 64	2VP 008 326-061	003 542 78 20	3AG 003 399-081	000 544 77 80	9GD 102 484-001
001 544 91 44	8GA 006 841-121	209 820 07 56	1NO 009 295-031	003 544 56 03	2VD 008 204-091	000 544 78 03	2SE 001 699-071
001 544 91 94	8GA 006 841-121	209 820 07 56	1NO 009 295-037	003 544 57 03	2VP 008 204-081	000 544 78 06	1NL 008 090-117
001 544 92 90	9EL 119 544-111	209 820 08 56	1NO 009 295-041	373 820 07 56	2SA 961 167-011	000 544 79 80	9GD 102 484-001
001 544 94 90	9EL 119 544-111	209 820 08 56	1NO 009 295-047	373 820 17 64	2SA 003 236-041	000 544 85 80	9GD 087 883-355
001 545 04 26	8JB 001 933-031	210 820 05 66	9AH 144 231-041	373 820 17 64	2SA 003 236-047	000 544 87 03	9GD 120 670-001
001 545 58 11	6ZE 001 759-071	210 820 06 66	9AH 144 232-041	373 820 17 64	2SA 003 236-048	000 544 93 03	2SE 002 562-071
001 545 89 32	1KL 007 834-027	210 820 35 61	1L9 378 158-001	373 820 18 64	2DA 003 236-031	000 544 99 03	2SD 001 699-061
163 820 47 61	1LL 223 151-031	210 820 36 61	1L9 378 159-001	373 820 18 64	2DA 003 236-037	000 545 07 81	9SG 703 965-007
163 820 48 61	1LL 223 151-041	210 820 39 66	9AH 378 392-001	381 820 31 61	1LH 002 658-451	000 545 13 47	1GA 998 522-011
164 820 77 61	1LL 263 064-031	210 820 40 66	9AH 378 393-001	381 820 32 61	1LH 002 658-461	000 545 21 15	2AA 001 200-011
164 820 78 61	1LL 263 064-041	211 820 05 56	1NB 008 275-031	381 820 33 61	1LH 002 658-511	000 545 21 15	2AA 001 200-012
170 820 01 56	1NB 007 555-031	211 820 05 61	1LL 008 369-171	381 820 34 61	1LH 002 658-521	005 545 21 14	6ED 708 919-001
170 820 02 56	1NB 007 555-041	211 820 06 56	1NB 008 275-041	381 820 41 61	1LH 002 658-451	000 500 57 17	8JA 003 526-001
171 820 01 64	2VP 008 427-091	211 820 06 61	1LL 008 369-181	381 820 42 61	1LH 002 658-461	000 580 01 97	2XM 004 444-001
171 820 02 64	2VP 008 427-101	211 820 11 56	1NB 008 275-071	003 820 01 56	2DA 959 071-237	000 583 09 53	2XW 003 146-001
000 000 00 01 72	8GH 007 643-121	211 820 12 56	1NB 008 275-081	003 820 13 56	2XS 005 020-001	000 583 29 53	2XW 002 897-041
001 820 00 56	2TJ 001 633-211	211 820 31 61	1LL 009 260-091	003 820 13 56	2XS 005 020-002	000 585 11 03	8XH 002 975-017
001 820 04 56	2XS 004 237-301	211 820 32 61	1LL 009 260-101	003 820 14 56	2XS 005 020-003	608 926 00 56	9EL 126 294-001
001 820 05 01	2AB 004 532-051	211 870 55 85	5DC 009 060-011	003 820 14 56	2XS 005 020-077	612 820 00 56	2KA 005 049-011
001 820 05 01	2AB 004 532-057	211 870 80 26	5DC 009 060-011	003 820 16 26	5DD 008 319-501	612 820 00 56	2KA 005 049-017
001 820 10 58	2RL 007 337-011	211 870 88 26	5DC 009 060-011	003 820 26 56	1KO 008 191-021	612 820 01 20	2BM 008 355-001
001 820 11 01	2AB 004 532-001	211 870 90 26	5DC 009 060-011	003 820 26 56	1KO 008 191-027	612 820 01 20	2BM 008 355-007
001 820 11 56	2XS 004 237-291	215 820 05 56	1NA 007 976-071	003 820 27 56	1NO 008 582-011	613 826 02 41	2PS 962 964-012
001 820 14 56	2KA 001 378-041	215 820 06 56	1NA 007 976-081	003 820 27 56	1NO 008 582-017	613 826 02 41	2PS 962 964-018
001 820 25 21	2BA 003 236-541	221 820 04 56	2DA 007 592-101	003 826 03 90	9EL 127 855-001	613 826 02 41	2PS 962 964-031
001 820 34 35	9MM 859 358-801	230 820 05 56	1NO 008 582-001	003 826 04 90	9EL 127 856-001	613 826 02 41	2PS 962 964-037
001 820 37 21	2BE 003 014-251	230 820 05 56	1NO 008 582-007	400 453 86 08	2BA 001 227-201	000 626 18 40	8RA 003 326-031
001 820 37 21	2BE 003 014-257	0002481V002L044	8GP 003 594-121	400 809 00 00 07	8GH 007 157-121	639 820 01 64	2SK 964 596-011
001 820 38 21	2BA 002 652-101	002 542 48 20	3AF 003 399-071	405 544 01 01	1DL 007 872-017	639 820 02 64	2SK 964 596-021
001 820 38 21	2BA 002 652-107	002 544 00 94	8GH 007 157-121	405 544 02 01	1DL 007 872-027	639 820 03 61	1LG 246 041-031
001 820 39 21	2BM 006 692-011	002 544 02 03	2SE 003 167-031	414 820 00 64	2VP 008 406-031	639 820 04 61	1LG 246 041-041
001 820 39 21	2BM 006 692-017	002 544 06 90	9EL 131 420-001	414 820 01 61	2VP 008 406-041	639 820 20 61	1LG 009 627-031
001 820 40 21	2BM 006 692-021	002 544 07 03	010 2VB 004 887-011	463 800 01 52	8JB 001 943-001	639 820 21 61	1LG 009 627-041
001 820 40 21	2BM 006 692-027	002 544 07 03	010 2VB 004 887-011	463 800 01 52	8JB 001 933-031	000 000 65 69	2HD 003 236-331
001 820 43 56	2XS 004 237-311	002 544 07 03	010 2VP 004 887-021	504 820 00 42	9MN 858 616-001	000 657 01 23	8GA 096 531-007
001 820 44 56	2XS 004 237-321	002 544 07 90	010 2VP 004 887-021	504 820 01 42	9MN 858 616-011	000 000 65 85	2NE 003 236-301
001 820 54 01	2JA 003 354-051	002 544 08 03	010 2VA 004 887-031	500 076 70 01	2AA 001 200-011	000 000 65 85	2NE 003 236-307
001 820 54 61	1L8 004 148-017	002 544 08 03	010 2VA 004 887-031	500 076 70 01	2AA 001 200-012	000 000 65 86	2PF 003 236-311
001 820 59 56	1NE 002 537-301	002 544 08 03	010 2VA 004 887-031	500 090 90 10	2ST 003 018-061	666 820 03 56	2ZR 003 236-151
001 820 67 01	2JA 007 372-001	002 544 09 03	010 2VA 004 887-031	500 090 90 18	2SD 001 679-001	667 546 01 37	9GT 141 941-001
001 820 67 21	2BA 001 423-087	002 544 12 90	9EL 134 296-041	500 090 90 19	2SD 001 259-261	671 820 04 56	2KA 006 896-001
001 820 68 56	2SA 001 647-041	002 544 13 03	2SD 001 680-271	500 923 90 15	9EL 088 150-001	671 820 04 56	2KA 006 896-007
001 820 72 41	9XS 027 639-001	002 544 14 03	2SD 001 680-281	500 923 90 20	9EL 088 525-001	673 820 00 21	2BA 002 652-101
001 820 72 41	2JA 006 447-251	002 544 15 03	2SE 001 680-291	500 944 00 34	2KA 001 386-231	673 820 00 21	2BA 002 652-107
001 820 83 01	2PF 006 717-011	002 544 16 03	2SE 001 680-301	000 544 07 75	9EL 134 301-011	000 000 68 20	2PF 006 679-007
001 820 89 21	2BA 008 221-001	002 544 16 90	9EL 134 296-051	000 544 01 29	2PF 003 057-001	000 000 68 21	2XW 004 237-291
001 820 89 21	2BA 008 221-007	002 544 19 90	9EL 122 772-051	000 544 01 34	2KA 001 386-241	000 000 68 22	2XS 004 237-301
001 820 96 56	2PF 002 860-031	002 544 20 90	9EL 122 772-001	000 544 04 86	8JA 001 909-011	000 000 68 28	2PF 001 647-301
001 820 97 56	2SA 002 860-041	002 544 21 90	9EL 134 301-001	000 544 05 47	1G8 002 340-001	000 000 68 28	2PF 001 647-037
001 822 00 10	9EL 852 827-001	002 544 26 03	2VD 005 300-551	000 544 06 12	9EL 146 838-001	000 000 68 85	2NE 003 236-301
001 822 01 10	9EL 855 097-001	002 544 31 03	2SL 003 567-311	000 544 09 47	1GA 005 060-001	000 000 68 85	2NE 003 236-307
001 822 24 10	9EL 852 061-001	002 544 31 94	8GH 007 643-121	000 544 09 47	1GD 003 590-701	000 000 68 86	2ZR 003 236-311
001 822 25 20	2BA 001 240-301	002 544 32 94	8GS 007 001-121	000 544 11 04	2NE 003 236-001	699 544 03 03	2SK 003 567-331
001 822 26 20	2BA 001 234-251	002 544 40 03	2VD 005 300-581	000 544 11 04	2NE 003 236-008	699 544 04 03	2SK 003 567-321
001 822 27 20	2BA 001 234-261	002 544 42 03	2VD 005 300-551	000 544 13 04	2NE 002 589-047	700 485 00 40	2BA 002 324-001
001 822 28 20	2BA 001 240-301	002 544 47 90	9EL 152 891-001	000 544 13 47	1GA 998 522-011	700 485 80 01	1LG 110 910-001
001 822 34 20	2BA 002 324-011	002 544 54 03	2VP 008 204-101	000 544 16 18	1ND 122 390-001	711 185 01 10	2SD 001 686-101
001 822 35 20	2BA 002 324-021	002 544 55 03	2VD 008 204-111	000 544 17 04	2NE 006 609-001	711 185 50 50	9EL 852 061-001
001 822 40 20	2BA 001 234-251	002 544 57 03	2SD 003 167-531	000 544 17 04	2NE 006 609-007	716 185 50 50	2KA 001 610-501
001 822 41 20	2BA 001 234-261	002 544 58 03	2SD 003 167-541	000 544 18 04	2NE 003 236-301	716 285 02 30	2SK 003 567-331
001 822 48 20	2BM 002 847-011	002 544 62 90	9EL 136 833-011	000 544 18 04	2NE 003 236-307	716 285 02 40	2SK 003 567-321
001 822 49 20	2BM 002 847-021	002 544 63 90	9EL 136 825-011	000 544 20 37	2KA 003 010-007	717 193 55 20	3AG 003 399-101
001 822 50 20	2BM 002 847-021	002 544 91 03	2VP 007 500-521	000 544 24 04	2ZR 003 236-051	755 601 20 02 0	2AB 004 532-051
001 822 51 20	2BM 002 847-011	002 544 97 03	2VP 008 204-081	000 544 24 07	2ZR 003 236-057	755 601 20 02 0	2AB 004 532-057
001 822 65 10	9EL 856 418-001	002 544 98 03	2VD 008 204-091	000 544 26 18	1G8 132 233-011	758 185 00 30	2BA 002 652-101
001 822 66 10	9EL 856 417-001	002 820 34 56	2PS 006 717-071	000 544 27 93	9FF 090 500-001	758 185 00 30	2BA 002 652-107
001 822 66 20	2BA 001 227-211	002 820 37 56	1NE 006 300-201	000 544 28 34	2KA 001 386-281	007 997 13 92	9XR 854 840-001
001 822 67 20	2BA 003 197-011	002 820 39 56	1FE 006 300-191	000 544 29 05	8RL 002 009-021	000 820 00 50	2JA 003 354-001
001 822 68 20	2BA 003 197-021	002 820 47 56	2PF 006 679-007	000 544 30 05	8RA 002 014-031	000 820 00 52	2AB 001 208-001
001 822 72 20	2BA 002 652-111	002 820 57 56	2XS 003 168-071	000 544 30 05	8RA 002 014-032	000 820 02 21	2BA 003 110-011
001 822 72 20	2BA 002 652-117	002 820 69 25	5DD 008 319-501	000 544 30 34	2KA 001 386-231	000 820 03 21	2BA 003 110-021
001 822 73 20	2BA 002 652-121	002 820 69 26	5DD 008 319-501	000 544 32 05	8RL 002 009-021	000 820 04 57	2DA 959 071-737
001 822 73 20	2BA 002 652-127	002 820 90 56	2DA 007 421-001	000 544 32 07	2BA 003 236-177	000 820 05 21	9EL 120 652-001
001 822 78 10	9EL 856 415-001	002 820 90 56	2DA 007 421-007	000 544 32 34	2KA 001 386-281	000 820 06 21	2BA 003 411-001
001 822 79 10	9EL 856 416-001	002 826 03 90	9EV 113 436-005	000 544 33 07	2ZR 003 236-311		



Manufacturer's no. / Hella no.

Cross-Reference

Mercedes-Benz	Hella	Mercedes-Benz	Hella	Messmer	Hella	NATO	Hella
000 820 61 21	2BM 002 652-051	000 826 43 10	9ES 247 754-001	221 063	6EG 001 567-041	6220-12-168-9882	9ES 012 060-011
000 820 62 21	2BA 003 975-031	000 826 43 47	2BA 001 259-611	451 174	2AA 003 257-001	6220-12-171-1301	2JA 001 364-001
000 820 63 01	2JA 003 115-031	000 826 43 47	2BA 001 259-618	451 175	2AA 003 257-011	6220-12-172-9248	2KA 001 386-231
000 820 63 21	2BA 003 975-041	000 826 44 81	9DE 089 102-011	451 176	2AA 003 257-021	6220-12-172-9251	2ZR 001 193-011
000 820 63 56	2ZR 003 030-171	000 826 46 10	9ES 170 064-021	451 177	2AA 003 257-031	6220-12-173-2259	2KA 001 386-281
000 820 68 21	9EL 129 615-011	000 826 47 10	9ES 170 064-011	451 315	2AA 003 257-041	6220-12-174-0100	2PF 001 634-101
000 820 69 21	9EL 129 614-011	000 826 54 90	9ES 091 489-001	Mitsubishi	Hella	6220-12-174-2805	2KA 001 389-101
000 820 71 10	6ZE 001 759-051	000 826 63 90	9ES 084 374-001	DO-001-007	8JA 001 909-001	6220-12-176-0704	2JA 003 231-001
000 820 72 56	2NE 003 030-151	000 826 65 99	1FE 125 510-011	MB958902	8GM 002 091-131	6220-12-176-4379	2SD 001 685-231
000 820 74 21	9EL 120 652-001	000 826 66 24	9GH 156 191-001	MR910391	8GP 003 594-121	6220-12-176-4379	2SD 001 685-232
000 820 79 21	2BM 002 652-071	000 826 73 82	9FH 113 447-011	S119021	8GM 002 092-121	6220-12-176-2125	2BA 002 324-011
000 820 80 21	2BM 002 652-081	000 826 87 81	9DE 116 734-007	S345133	8GA 006 841-121	6220-12-178-3324	2BA 001 221-041
000 820 81 21	9EL 129 615-011	000 826 95 80	9GD 052 710-021	SMB958902	8GM 002 091-131	6220-12-178-3325	2BA 001 221-031
000 820 82 21	9EL 129 614-011	000 826 95 81	9DE 116 734-007	SMME31640S6	1KO 008 191-001	6220-12-178-3348	2BA 002 324-021
000 820 87 01	2JA 001 330-001	000 826 98 99	1L8 139 474-015	SMME31640S6	1KO 008 191-007	6220-12-178-3722	2BA 002 324-001
000 820 87 01	2JA 001 330-007	000 826 99 80	9GD 113 431-005	SMMME31640S7	2BA 009 001-201	6220-12-178-3921	9EL 116 607-005
000 820 87 56	2ZR 003 030-171	000 827 07 31	9GH 152 654-007	SMMME31640S9	1LL 008 193-117	6220-12-178-3922	9EL 110 014-001
000 820 89 20	2BA 001 227-211	000 827 08 31	9GH 158 051-007	SMR910391	8GP 003 594-121	6220-12-178-3922	9EL 110 013-001
000 820 90 56	2KA 003 389-061	84 2070 9900-31	2BA 002 324-001	SMZ313636	1G3 005 760-011	6220-12-178-4344	2JA 002 661-001
000 820 90 56	2KA 003 389-062	86 0533 9352-09	2BA 001 248-001	SMZ313637	1F3 009 094-011	6220-12-178-4672	2BM 002 847-021
000 820 90 56	2KA 003 389-068	86 0535 9351-03	9EL 110 918-001	Z0412314	2XW 003 146-001	6220-12-178-4673	9EL 115 830-001
000 820 93 56	2XS 005 020-001	86 0535 9357-19	2BA 002 324-011	Z0430103	8GS 007 949-101	6220-12-179-5082	9EL 116 771-031
000 820 93 56	2XS 005 020-002	86 0535 9357-20	2BA 002 324-021	Z0430122	8GP 002 066-121	6220-12-179-5622	2SE 001 699-071
000 820 94 56	2XS 005 020-003	86 1019 4054-90	2SD 001 679-001	Z1219011	2XS 005 020-017	6220-12-180-4221	8KA 002 309-811
000 820 94 56	2TJ 001 633-211	86 1041 0603-60	2SB 003 018-031	Z1219011	2XS 005 020-017	6220-12-180-9533	9EA 001 275-011
000 820 95 56	2TJ 003 168-151	88 0001 1067-32	9EL 110 910-001	Z1219068	2PS 006 717-061	6220-12-180-9539	9EL 109 139-001
000 820 96 56	2PF 001 638-067	901 820 01 21	2BA 007 016-031	Z1219161	2PS 006 717-067	6220-12-181-0915	2JA 001 357-012
000 821 01 25	8JA 001 909-001	901 820 02 21	2BA 007 016-041	Z1219161	2PS 003 748-161	6220-12-181-0915	2BM 002 847-011
000 821 10 61	5DV 009 000-001	901 820 02 56	2NE 003 315-011	Z1219241	2PS 003 748-167	6220-12-181-1890	9EV 113 436-005
000 822 04 07	2AA 001 200-151	901 820 02 56 X	2NE 003 315-011	Z1519800	8GP 003 594-241	6220-12-181-6666	2ZR 003 030-171
000 822 04 90	9EL 854 912-001	901 820 03 56	2ZR 003 315-041	Z1719041	4RA 003 530-001	6220-12-181-7671	2BA 003 014-011
000 822 27 20	2BA 001 234-261	901 820 03 61	1LH 006 900-031	Z1719051	1FE 006 300-041	6220-12-181-8961	9EL 101 900-001
000 822 30 88	9DX 859 560-001	901 820 04 61	1LH 006 900-041	Z1719089	1NE 006 300-051	6220-12-181-8962	9EL 101 899-001
000 822 31 88	9DX 859 625-001	901 820 12 61	1LH 008 010-031	Z1719090	8GH 002 089-133	6220-12-181-8963	2BA 001 275-021
000 822 33 97	9GD 856 562-001	901 820 13 61	1LH 008 010-041	Z1719121	8GH 002 090-133	6220-12-182-6686	2NE 001 423-011
000 822 34 97	9GD 856 683-001	901 820 28 61	1LH 246 047-031	Z1719121	8GP 003 594-121	6220-12-183-8555	2SD 001 699-061
000 822 35 88	9DX 859 626-001	901 820 29 61	1LH 246 047-041	Z1719191	1FE 002 537-191	6220-12-183-9749	9EL 088 150-001
000 822 43 10	9EL 116 907-001	901 820 30 61	1LH 246 047-071	Z1719201	1NE 002 537-201	6220-12-184-8508	9EL 852 820-001
000 822 49 10	9EL 101 899-001	901 820 31 61	1LH 246 047-081	Z1719309	8KA 002 309-811	6220-12-185-0513	9EL 113 065-001
000 822 50 10	9EL 101 900-001	906 820 03 61	1LH 247 012-031	Z1719621	1N8 007 560-021	6220-12-186-4524	2BA 001 277-011
000 822 74 10	9EL 052 476-001	906 820 04 61	1LH 247 012-041	Z1719631	1N8 007 560-031	6220-12-191-2085	2ZR 001 423-001
000 822 75 10	9EL 110 377-001	906 820 07 61	1LH 247 012-071	Z1719641	1F8 007 560-041	6220-12-191-3487	2SD 003 167-021
000 822 76 10	9EL 110 736-001	906 820 08 61	1LH 247 012-081	Z1719651	2ZR 006 609-081	6220-12-191-3488	2SE 003 167-031
000 822 77 10	9EL 109 440-002	9 19 6 263698 02	2NE 002 589-001	Z2219609	2ZR 006 609-087	6220-12-192-3516	2JA 003 232-011
000 822 80 20	2BA 001 275-011	9 19 6 263698 03	2ZR 002 589-011	Z2219609	2NE 006 609-081	6220-12-192-6271	2SD 002 582-011
000 822 81 20	2BA 001 275-021	939 723 10 93 01	2XS 950 071-031	Z2219660	2NE 006 609-007	6220-12-192-6272	2SD 002 582-017
000 822 86 10	9EL 110 918-001	940 820 03 21	2BA 247 015-031	Z2219660	2NE 006 609-007	6220-12-192-6272	2SD 002 582-021
000 822 88 10	9EL 115 830-001	940 820 04 21	2BA 247 015-041	NATO	Hella	6220-12-192-6272	2KA 001 386-291
000 825 00 03	2ZR 002 589-011	940 820 05 61	1LH 247 011-051	2510-12-192-0042	8HG 002 240-021	6220-12-192-7485	2JA 001 335-011
000 825 00 14	9XB 136 202-005	940 820 06 61	1LH 247 011-061	2590-12-195-8585	3AF 003 399-071	6220-12-193-8425	2KA 003 168-021
000 825 02 03	2KA 001 389-101	943 820 18 61	1LH 009 513-051	2590-12-195-8585	3AF 003 399-061	6220-12-194-3370	2BE 003 184-051
000 825 05 01	2JA 001 357-002	943 820 19 61	1LH 009 513-061	2590-12-196-0842	3AG 003 399-081	6220-12-195-1959	2BM 001 318-001
000 825 06 03	2PF 004 081-001	943 820 20 61	1LH 009 513-071	5325-12-153-1910	9GT 005 166-001	6220-12-196-0266	2SE 003 167-021
000 825 06 03	2PF 004 081-007	943 820 21 61	1LH 009 513-081	5325-12-191-1793	9GT 074 132-001	6220-12-196-2592	1X0 001 515-021
000 825 07 01	2JA 001 357-002	943 826 02 59	9AB 165 229-031	5330-12-127-3814	9GD 024 183-001	6220-12-196-2754	2PF 001 648-161
000 825 08 14	2JA 001 357-012	943 826 03 59	9AB 165 230-031	5330-12-168-9819	9GD 052 710-021	6220-12-197-0647	2NE 002 985-001
000 825 30 10	9EL 116 607-005	957 540 04 40	8HG 153 152-001	5330-12-179-0308	9GD 023 639-001	6220-12-197-1856	2SD 003 184-031
000 825 36 10	9EL 112 858-011	957 820 00 01	2JA 006 447-041	5330-12-181-2502	9GD 113 431-005	6220-12-197-1856	2SD 003 184-037
000 825 54 10	9EL 120 240-011	957 820 02 61	1DL 007 872-077	5330-12-181-2502	9GD 120 670-001	6220-12-197-3499	2SE 001 685-201
000 825 60 01	2PT 008 935-001	957 820 03 61	1DL 007 872-087	5330-12-181-4797	9GD 100 140-001	6220-12-197-5071	9EL 852 061-001
000 826 00 26	8JB 850 434-011	973 820 05 21	2BA 247 016-031	5330-12-183-1675	9GD 100 140-001	6220-12-197-6875	1G4 003 470-051
000 826 04 44	2SE 001 699-011	973 820 06 21	2BA 247 016-041	5330-12-302-4690	9GD 087 883-355	6220-12-198-3109	1G8 002 340-011
000 826 04 47	2PF 001 647-031	000 993 00 98	9XR 855 975-001	5340-12-181-4796	9GH 096 532-001	6220-12-198-8343	1G5 003 241-081
000 826 04 47	2PF 001 647-037	000 997 32 86	9GH 096 532-001	5340-12-185-0512	9GH 116 966-011	6220-12-199-2686	2SA 003 057-021
000 826 06 56	9EL 950 315-001	000 997 80 81	9GT 074 132-001	5355-12-179-4110	9SG 703 965-007	6220-12-300-3102	2KA 003 389-061
000 826 06 56	9EL 950 315-031	000 997 80 91	9GT 074 132-001	5360-12-151-8828	9KS 075 139-001	6220-12-300-3102	2KA 003 389-062
000 826 07 14	9XD 247 755-001	000 997 95 81	9GT 067 751-001	5930-12-178-7323	6ZE 001 759-051	6220-12-300-3102	2KA 003 389-068
000 826 08 14	9XD 247 756-001	000 998 57 05	9GT 137 236-007	5935-12-127-9479	8JA 001 915-001	6220-12-300-3198	9BG 119 721-001
000 826 09 97	9GD 100 140-001	009 997 87 81	9GT 146 757-007	5935-12-133-3200	8JA 001 925-001	6220-12-300-7833	9EL 108 435-001
000 826 10 40	8RA 003 660-007	HKV 300 000 00 02	1NL 007 186-061	5935-12-145-4256	9GH 096 532-001	6220-12-300-8045	9DE 116 734-007
000 826 10 44	2SD 001 693-011	HKV 300 000 00 02	1NL 007 186-067	5935-12-168-6918	8JA 001 914-011	6220-12-301-3642	9EL 110 737-001
000 826 11 40	8RA 002 014-041	HKV 300 000 00 03	2BA 002 939-251	5935-12-177-1842	8JA 001 930-001	6220-12-301-3643	2BA 001 234-251
000 826 11 40	8RA 002 014-042	HKW221820T004	2XD 008 997-001	5935-12-177-1844	8JB 001 943-001	6220-12-301-4206	9EL 110 736-001
000 826 11 80	9GD 024 183-001	HXB 373 820 17 64	2SA 003 236-041	5935-12-186-9559	8JA 001 909-011	6220-12-301-6923	9EL 119 874-001
000 826 12 24	9HD 121 297-001	HXB 373 820					

Manufacturer's no. / Hella no.

Cross-Reference



NATO	Hella	Neoplan	Hella	Neoplan	Hella	Neoplan	Hella
6240-12-129-6155	8GD 002 088-131	1102 534 2	2ZR 002 694-001	1108 047 1	8RA 008 405-001	1503.250.02	9GT 143 133-007
6240-12-129-6156	8GD 002 088-251	1102.534.3	2ZR 003 236-311	1108 047 1	8RA 008 405-007	1503.253.00	2SD 003 184-031
6240-12-129-6157	8GD 002 084-131	1102 534 4	2TM 003 748-011	1108 060 8	8WT 008 549-601	1503.253.00	2SD 003 184-031
6240-12-136-1126	8GA 002 074-241	1102.534.5	9EL 119 544-111	1108 061 0	8WT 008 549-701	1503.28	2SD 003 167-021
6240-12-137-2181	8GA 002 074-121	1102.534.6	2ZR 005 603-061	1108 067 9	2JB 996 012-121	1503.300.00	2ZR 002 694-001
6240-12-140-5265	8GA 002 072-121	1102.534.6	2ZR 005 603-067	1108 253 3	8KA 152 134-007	1503.301.00	2ZR 001 193-011
6240-12-147-2781	8GM 002 091-121	1102 534 7	2ZR 005 603-061	1111 389 8	2JA 001 346-011	1503.302.00	2ZR 003 236-311
6240-12-150-4410	8GA 002 073-241	1102 534 7	2ZR 005 603-067	1111 461 6	2PF 959 590-401	1503.303.00	2TM 003 748-011
6240-12-151-9661	8GH 002 089-251	1102.534.8	2KA 001 378-041	1111 461 6	2PF 959 590-407	1503.303.01	9EL 119 544-111
6240-12-159-7268	8GH 002 089-253	1102.534.9	2KA 005 049-011	1112 388 4	3AF 003 399-061	1503.307.00	2ZR 005 603-061
6240-12-165-3331	8GA 002 073-121	1102.534.9	2KA 005 049-011	1112 835 8	2PS 009 226-017	1503.307.00	2ZR 005 603-067
6240-12-165-6793	8GJ 002 525-251	1102.535.0	2KA 003 389-061	111 283 60	2BM 008 355-001	1503.35	9EL 107 443-061
6240-12-165-6793	8GH 002 090-251	1102.535.0	2KA 003 389-062	111 283 60	2BM 008 355-007	1503.380.00	2SA 001 647-041
6240-12-165-6793	8GH 002 090-253	1102.535.0	2KA 003 389-068	111 283 60	2BM 008 355-017	1503.400.00	2KA 001 378-041
6240-12-166-0983	8GH 002 090-133	1102 535 1	2KA 001 622-001	1113 245 2	2SA 009 001-137	1503.401.00	2KA 005 049-008
6240-12-171-6626	8GP 002 095-121	1102.535.6	2KA 005 049-011	1113 245 3	2BA 009 001-107	1503.402.00	2KA 003 389-061
6240-12-173-3418	8GP 002 095-241	1102.535.6	2KA 005 049-017	1114 574 3	2PF 003 563-187	1503.402.00	2KA 003 389-062
6240-12-173-4825	8GA 002 071-251	1102.542.1	2SK 003 567-321	1200 613 0	2PF 959 570-401	1503.402.00	2KA 003 389-068
6240-12-179-9642	8GJ 002 525-131	1102.544.2	8RA 003 326-041	1200 613 0	2PF 959 570-407	1503.403.00	2KA 001 622-001
6250-12-122-4544	9FF 078 830-001	1102.544.2	8RA 003 326-047	1400 681 3	2PF 002 860-031	1503.405.00	2KA 003 010-007
6250-12-179-0634	9FF 090 500-001	1102 544 6	8RA 003 326-001	1401 191 4	2PS 963 639-011	1503.407.00	2KA 003 168-021
6250-12-180-6310	9FF 085 642-001	1102 544 6	8RA 003 326-002	1401 191 4	2PS 963 639-017	1503.408.00	2KA 005 049-011
6250-12-185-3302	9FF 071 116-001	1102.544.7	8RL 002 009-011	1401 502 7	8JD 156 151-807	1503.408.00	2KA 005 049-017
6250-12-300-5036	9FH 113 447-011	1102.544.8	8RL 002 009-021	1502 204.00	2NE 005 603-071	1503.511.10	1F8 007 560-041
9390-12-169-3186	9GD 023 639-001	1102.545.4	8RB 004 713-001	1502 204.00	2NE 005 603-077	1503.513.00	1FD 003 590-411
9905-12-127-4384	8RA 002 010-011	1102.546.2	2SA 001 647-041	1502 205.00	2SK 003 567-661	1503.527.00	1GD 003 590-701
9905-12-129-1636	8RA 002 015-031	1102.546.4	2PF 961 167-021	1502 206.00	2SK 003 567-651	1503.541.20	2XS 005 020-041
9905-12-139-8150	8RA 002 016-121	1102.546.9	2PF 002 860-031	1502 207.00	9HB 126 601-001	1503.541.20	2XS 005 020-047
9905-12-162-7370	8RA 002 016-101	1102.547.0	9GD 128 553-007	1503.000.00	9GH 145 943-001	1503.700.00	8RA 003 326-011
9905-12-172-5334	8RA 002 016-111	1102.547.3	2SA 002 860-041	1503.003.01	2BA 002 939-171	1503.700.00	8RA 003 326-017
9905-12-175-7514	8RA 002 023-011	1102.547.5	1NL 007 186-027	1503.003.02	9EL 116 771-031	1503.700.10	8RA 003 326-041
9905-12-181-7721	8RA 002 015-001	1102.547.5	2JA 005 590-001	1503.004.00	2BM 002 847-011	1503.700.10	8RA 003 326-047
9905-12-188-3859	8RA 002 014-051	1102.548.8	2SA 001 638-021	1503.004.01	9EL 115 830-001	1503.700.50	8RA 003 326-021
9905-12-188-3859	8RA 002 014-052	1102.548.9	2PF 001 638-011	1503.005.00	2BM 002 847-021	1503.701.00	8RA 003 660-007
9905-12-191-1123	8RA 003 326-011	1102.549.1	2XS 005 020-001	1503.006.00	2BA 001 275-011	1503.702.00	8RL 002 009-021
9905-12-191-1123	8RA 003 326-017	1102.549.1	2XS 005 020-002	1503.006.01	9EL 101 899-001	1503.703.00	8RL 002 009-011
9905-12-300-2792	8RA 002 023-001	1102.549.1	2XS 005 020-003	1503.007.00	2BA 001 275-021	1503.704.00	8RL 002 009-021
9905-12-304-8722	8HG 002 240-011	1102.549.3	2XS 007 841-011	1503.009.00	2BA 001 221-031	1503.743.00	8RB 004 713-001
9905-12-306-9555	8HG 002 240-001	1102.549.3	2XS 007 841-017	1503.010.00	2BA 001 221-041	1503.746.00	2XS 955 031-001
		1102 549 4	2XS 007 841-021	1503.012.00	2BA 003 236-321	1503.801.00	2PF 001 647-031
		1102 549 9	2XS 007 841-027	1503.013.00	2BA 003 236-021	1503.801.00	2PF 001 647-037
		1102.550.0	8GA 002 074-241	1503.013.00	2BA 003 236-027	1503.802.00	2PF 961 167-021
		1102.553.0	4AZ 003 787-021	1503.013.02	9EL 119 544-021	1503.804.00	2SA 003 014-051
		1102.553.0	2JA 004 531-011	1503.015.00	2BA 003 236-177	1503.805.00	2PF 003 014-071
		1102.553.2	2JA 007 372-011	1503.016.00	2BA 003 734-061	1503.806.00	2PF 002 860-031
		1102.553.2	2SA 001 259-751	1503.043.00	2BA 005 603-011	1503.806.02	9GD 128 553-007
		1102.553.2	2SA 001 259-757	1503.043.00	2BA 005 603-017	1503.811.00	2JA 005 590-001
		1102.554.2	2JA 003 231-001	1503.052.00	2BA 001 259-611	1503.817.00	2PF 004 081-001
		1102.554.5	2JA 003 354-051	1503.052.00	2BA 001 259-618	1503.817.00	2PF 004 081-007
		1102 554 6	9EL 120 240-011	1503.065.00	2KA 003 389-001	1503.905.00	2SA 001 638-021
		1102.554.7	2JA 001 331-011	1503.079.00	2ZR 002 589-011	1503.906.00	2PF 001 638-011
		1102.556.6	2JA 001 364-001	1503.081.00	2ZR 003 236-051	1503.907.00	2XS 005 020-001
		1102.558.3	2AB 004 532-051	1503.081.00	2ZR 003 236-057	1503.907.00	2XS 005 020-002
		1102.558.3	2AB 004 532-057	1503.082.00	8RA 003 326-011	1503.907.00	2XS 005 020-003
		1102.558.5	9XB 136 202-005	1503.082.00	8RA 003 326-017	1503.907.01	9EL 132 215-001
		1102 572 7	8JA 003 526-001	1503.101.00	2DA 003 236-331	1503.907.10	2XS 007 841-011
		1102 710 7	8JA 003 526-001	1503.102.00	2DA 003 236-031	1503.907.10	2XS 007 841-017
		1102.776.1	9GT 143 133-007	1503.102.00	2DA 003 236-037	1503.907.20	2XS 007 841-021
		1102.871.0	8GP 003 594-241	1503.102.01	9EL 120 201-001	1503.907.20	2XS 007 841-027
		1102 871 2	8GA 002 071-251	1503.103.00	2ZR 003 236-051	1504.012.00	2JA 003 236-357
		1102 872 3	8GJ 002 525-251	1503.103.00	2ZR 003 236-057	1504.016.00	2JA 004 531-011
		1102 872 4	8GH 002 089-251	1503.105.00	9EL 110 014-001	1504.016.01	9EL 856 010-001
		1102 872 4	8GH 002 089-253	1503.108.00	2DA 005 603-031	1504.019.00	2SA 001 259-751
		1102 872 9	8GS 007 949-101	1503.108.00	2DA 005 603-037	1504.019.00	2SA 001 259-757
		1102 877 1	8GM 002 092-241	1503.114.00	9GD 100 140-001	1504.027.00	2JA 001 335-011
		1102 890 0	9EL 119 544-111	1503.141.00	2ZR 003 014-091	1504.032.00	2JA 003 231-001
		1102.912.5	8KW 701 235-033	1503.142.00	2BM 006 692-011	1504.033.00	9EL 020 661-001
		1105.237.9	2XW 007 146-001	1503.142.00	2BM 006 692-017	1504.037.10	2JA 120 240-011
		1105.238.6	2XW 007 146-001	1503.143.00	2BM 006 692-021	1504.039.00	2JA 001 331-011
		1105779.2	2SA 005 603-021	1503.143.00	2BM 006 692-027	1504.041.00	9EL 855 097-001
		1106 074 0	9GD 100 140-001	1503.145.00	2SA 006 679-027	1504.106.00	2JA 001 364-001
		1106.173.5	8JB 004 777-001	1503.148.00	2PS 962 964-012	1504.207.00	2AB 004 532-051
		1106.173.5	8JB 004 777-002	1503.148.00	2PS 962 964-018	1504.207.00	2AB 004 532-057
		1106 390 1	2BM 008 355-001	1503.148.10	9GT 963 129-001	1504.207.05	9XB 136 202-005
		1106 390 1	2BM 008 355-007	1503.148.20	9GD 963 281-001	1504.637.10	9EL 120 240-011
		1106.848.3	2NE 008 221-031	1503.160.00	2BA 003 734-061	1505.548.00	8JA 003 526-001
		1106.848.3	2NE 008 221-037	1503.203.00	2NE 003 236-001	1508.021.00	8JA 001 909-001
		1106.848.4	8RA 008 405-001	1503.203.00	2NE 003 236-008	1508.023.01	8JA 003 526-001
		1106.848.4	8RA 008 405-007	1503.203.02	9EL 119 544-001	1508.148.00	2PS 962 964-012
		1107.081.0	2XS 008 479-041	1503.205.02	9EL 119 544-001	1508.148.00	2PS 962 964-018
		1107.081.0	2XS 008 479-047	1503.207.00	2SD 001 693-011	1508.377.00	8JA 004 667-001
		1107.081.1	2XS 008 479-051	1503.208.00	2SD 003 184-041	1510.005.00	8GH 002 473-151
		1107.081.1	2XS 008 479-057	1503.208.00	2SD 003 184-047	1510.006.00	8GP 003 594-241
		1107.376.4	1K0 008 191-021	1503.209.00	2SD 003 184-031	1510.008.00	8GA 002 071-251
		1107.376.4	1K0 008 191-027	1503.209.00	2SD 003 184-037	1510.021.00	8GP 003 594-251
		1107.376.7	1N0 008 582-011	1503.211.00	2SA 003 236-341	1510.305.00	8GM 002 092-241
		1107.376.7	1				



Manufacturer's no. / Hella no.

Cross-Reference

Neoplan	Hella	New Holland	Hella	O & K	Hella	O & K	Hella
36.25201-6013	2JA 003 231-001	1-40-172-0161	1GA 996 083-011	0014689	2BA 001 227-211	0201586	9EL 088 525-001
36.25202-6003	2AB 004 532-051	1-40-179-0021	1GA 998 522-011	0014702	2AA 001 200-001	2142382	8RA 003 326-031
36.25202-6003	2AB 004 532-057	1-40-179-0031	1GA 998 522-011	0017209	8HG 006 294-011	0125034	8RA 002 015-021
36.25205-6000	2JB 996 012-121	1-40-572-0011	1GA 996 083-011	0014703	2AA 001 200-011	215139	3AC 003 399-101
36.25225-6000	2XA 008 221-021	1-40-572-0021	1GA 907 506-681	0014703	2AA 001 200-012	2168625	8RA 002 016-121
36.25225-6000	2XA 008 221-027	421030	1G3 005 760-001	0014703	2AA 001 200-131	2168728	8JB 004 777-001
36.25225-6001	2NE 008 221-031	421030	1G3 005 760-057	0014703	8RA 002 015-001	2168728	8JB 004 777-002
36.25225-6001	2NE 008 221-037	47056352	1GA 996 083-011	0014808	9ES 015 675-001	0217768	9DR 090 206-001
36.25225-6002	2DA 959 071-737	470563520	1GA 996 083-011	14812	2AA 001 200-021	0219034	2AA 001 200-151
36.25225-6006	2DA 005 603-031	47056353	1GA 996 083-011	14812	2AA 001 200-023	2213549	8GS 861 955-021
36.25225-6006	2DA 005 603-037	470563530	1GA 996 083-011	1484339	9EL 136 825-001	2292413	2PS 006 717-031
36.25225-6007	2SA 005 603-021	470563540	1GA 996 083-021	1484340	9EL 136 825-011	2292413	2PS 006 717-032
36.25225-6007	2SA 005 603-027	470563550	1GA 996 083-021	14894	2SA 001 634-121	2292413	2PS 006 717-037
36.25225-6008	2SD 003 184-031	470563560	1GA 996 083-011	0014911	2SA 001 389-101	2292414	8GP 003 594-251
36.25225-6008	2SD 003 184-037	470563570	1GA 996 083-011	1494060	8GH 002 089-133	244872	8GA 002 073-121
36.25225-6009	2SD 003 184-041	81813545	8RA 002 016-121	1494061	9EL 860 627-001	2465155	1GA 006 991-041
36.25225-6009	2SD 003 184-047	83959697	1L3 005 649-017	1494063	9MN 860 677-001	2482231	9GH 993 984-001
36.25225-6015	2PS 009 226-017	84059809	1GA 007 506-101	1494134	9EL 964 532-001	2490165	8RA 002 016-101
36.25240-6000	2KA 005 049-011	9813938	1GA 006 991-091	014965	8JA 001 925-001	0249135	2ZR 001 423-001
36.25240-6000	2KA 005 049-017	9819611	1GA 005 060-041	1520715	2SK 003 567-321	002614	2ST 003 018-061
36.25260-6000	2PF 008 221-011	9819611	1GA 998 522-011	1520716	2SK 003 567-331	0264485	8GA 002 071-251
36.25260-6000	2PF 008 221-017	9837139	1GB 006 213-101	1537245	8RA 003 326-041	0264745	2BE 003 185-031
36.25260-6004	2XS 008 479-051	9837139	1GB 006 213-107	1537245	8RA 003 326-047	2764283	2RL 008 161-111
36.25260-6004	2XS 008 479-057	9837140	1GA 006 991-061	1537807	2JA 003 354-001	2764317	8GS 007 949-101
36.25260-6005	2XS 008 479-041			1547165	2JA 001 357-002	2764366	8GS 007 949-101
36.25260-6005	2XS 008 479-047			1570318	8JA 001 909-001	2764793	2JA 007 373-071
36.25260-6006	2PF 959 590-401			1589704	1S0 001 430-011	2764945	1GA 996 142-011
36.25260-6006	2PF 959 590-407			0159615	8JB 001 933-031	2764945-301	1GA 996 142-011
36.25260-6009	2PF 003 563-187			1710080	8HG 002 365-001	2781686	2VP 006 040-111
36.25260-6010	2PF 006 679-007			1710088	8HG 002 365-001	2781686	2VP 006 040-111
36.25320-6001	2BA 008 221-041			1710097	2SB 003 018-031	2781687	2VP 006 040-121
36.25320-6001	2BA 008 221-047			1710130	2KA 001 386-291	2781687	2VP 006 040-127
36.25320-6004	2BE 004 119-021			1710145	2KA 001 389-101	0028919	8GA 002 071-241
36.25320-6005	2BA 005 603-117			1710154	2SD 001 693-011	2900359	8GM 002 092-121
36.25320-6006	2BM 008 355-017			1710167	2BA 002 324-011	0029224	1S3 001 117-041
36.25323-000	8XU 008 405-031			1710168	2BA 002 324-021	2928271	1GA 006 876-001
36.25323-000	8XU 008 405-037			1710176	2BA 002 324-001	2928273	2RL 007 552-001
36.25943-6007	5DV 008 856-001			1710177	2SD 001 686-101	2928304	8GD 002 078-121
36.25943-6007	5DV 008 856-007			1710178	2SD 001 699-061	2928305	8GD 002 078-241
36.96001-0001	9GH 145 943-001			1710201	2BA 003 022-001	2928339	2SD 964 169-111
81.25205-6008	2JB 996 012-121			1710202	2PS 002 727-001	2928339	2SD 964 169-117
81.25225-6107	2BM 002 847-011			1710205	2SE 001 699-071	2928340	2ZR 964 169-031
81.25225-6108	2BM 002 847-021			1710217	2BA 002 652-101	2928340	2ZR 964 169-037
81.25225-6459	2BM 006 692-011			1710217	2BA 002 652-107	2928380	2RL 007 552-011
81.25225-6459	2BM 006 692-017			1710218	2KA 003 389-001	2928475	8GA 002 071-131
81.25229-0244	9EL 122 772-001			1710218	2KA 003 389-061	2928659	8RA 002 014-031
81.25301-6045	3AF 003 399-061			1710218	2KA 003 389-062	2928659	8RA 002 014-032
81.25901-0016	8GA 002 073-241			1710218	2KA 003 389-068	2928660	8HG 003 799-001
81.25901-0102	8GA 006 841-241			1710220	2BA 002 652-111	2928660	2TM 003 057-031
81.42950-0028	8RL 002 009-021			1710220	2BA 002 652-117	2929205	2BA 996 012-061
81.42950-0043	8RA 003 660-007			1710221	2BA 002 652-121	2929206	9BC 993 345-001
81.42950-0065	8RA 003 326-001			1710221	2BA 002 652-127	2929215	3AF 003 399-071
81.42950-0065	8RA 003 326-002			1710243	2BA 003 734-061	2929704	2PF 996 012-051
82.25201-6001	2JA 003 354-051			1710248	2BE 003 014-251	2929764	8RA 002 014-051
82.25225-6031	2SK 003 567-331			1710248	2BE 003 014-257	2929764	8RA 002 014-052
83.25205-6501	2JA 001 364-001			1710265	2BE 003 182-091	2929867	2XS 005 020-081
83.25260-6504	2PF 959 570-401			1710266	2BE 003 182-101	2929902	8HG 006 294-051
83.25260-6504	2PF 959 570-407			1710312	2XS 950 071-031	2929939	9BG 990 042-061
84.25901-0021	8GA 002 074-241			1710313	2XS 005 020-001	2929941	2BA 996 012-147
88.25101-6007	1KO 008 191-021			1710313	2XS 005 020-002	2929941	8HG 006 294-091
88.25101-6007	1KO 008 191-027			1710313	2XS 005 020-003	2930153	2RL 008 062-101
88.25215-0001	8RA 008 405-001			1710318	2BA 003 014-111	2973835	2KA 001 389-101
88.25215-0001	8RA 008 405-007			1710319	2XS 955 031-001	2976502	8GA 002 073-241
88.25225-6012	2BA 001 221-031			1711003	8RA 002 016-111	2978085	2BA 002 652-101
88.25225-6023	2BA 003 236-541			1711052	8RA 003 326-011	2978085	2BA 002 652-107
88.25225-6026	2BA 008 221-001			1711052	8RA 003 326-017	2978643	2SD 002 776-231
88.25225-6026	2BA 008 221-007			1712038	8JA 001 909-011	2978643	2SD 002 776-237
N1.01102-5087	2NE 005 603-011			1712099	1G9 001 523-021	2978738	2SW 003 014-131
N1.01102-5087	2NE 005 603-077			1712118	2ZR 001 423-001	2981369	1GB 006 213-101
N1.01102-5089	2SK 003 567-661			1712132	1G5 003 241-021	2981369	1GB 006 213-107
N1.01102-5092	2SK 003 567-651			1712140	2ZR 003 014-091	2981369	2PF 001 634-101
N1.01102-5195	2BA 005 603-011			1712152	1G5 003 241-071	3004752	2BN 964 169-051
N1.01102-5195	2BA 005 603-017			1712154	1G8 002 340-001	3004752	2BN 964 169-057
N1.01102-5201	2BA 001 259-611			1712218	2KA 003 389-061	3004753	2TA 964 169-061
N1.01102-5201	2BA 001 259-618			1712218	2KA 003 389-062	3004753	2TA 964 169-067
N1.01102-5215	9EL 120 201-001			1712218	2KA 003 389-068	3005654	2BA 996 012-147
N1.01102-5244	2PS 962 964-012			1719025	2AA 001 200-011	0030229	8GP 002 067-241
N1.01102-5244	2PS 962 964-018			1719025	2AA 001 200-012	30230	8GM 002 092-241
N1.01102-5245	9GT 963 129-001			1719026	2AA 001 200-021	30234	2SD 001 679-001
N1.01102-5258	2SB 005 603-137			1719026	2AA 001 200-023	0033272	2BA 001 259-611
N1.01102-5270	2SD 003 184-031			1719027	2AA 001 200-031	0033272	2BA 001 259-618
N1.01102-5270	2SD 003 184-037			1719028	2AA 001 200-001	33766	8RA 002 016-111
N1.01102-5271	9EL 118 700-001			1725775	2KA 003 168-021	0339992	2BA 002 324-001
N1.01102-5322	1NL 007 834-017			1731213	6EH 004 406-032	0034464	2SB 001 259-261
N1.01102-5329	1NL 007 186-407			1732001	2PF 001 648-161	0034500	8GP 002 067-121
N1.01102-5344	2TM 003 748-011			1732001	2PF 001 638-011	0034774	2BA 001 248-001
N1.01102-5346	2ZR 005 603-061			1732024	2PF 003 014-071	34784	8GA 002 071-251
N1.01102-5346	2ZR 005 603-067			1737027	2JA 003 231-001	0035157	2AA 001 200-031
N1.01102-5441	8RA 003 326-011			1740048	1G4 003 470-051	0036652	2ZR 001 421-101
N1.01102-5441	8RA 003 326-017			1740450	9EL 110 918-001	3712131	1GM 996 136-191
N1.01102-5464	2PF 961 167-021			1794577	9EL 102 240-031	3712131	1GM 996 136-192
N1.01102-5491	2XS 005 020-001			1794629	9EL 110 910-001	37752	8GP 002 068-241
N1.01102-5491	2XS 005 020-002			1794675	1G5 119 738-001	0038280	9KS 075 139-001
N1.01102-5491	2XS 005 020-003			1794676	9GD 120 670-001	4158653	2JA 001 330-001
N1.01102-5493	2XS 007 841-011			1794677	6ED 708 919-001	4158653	2JA 001 330-007
N1.01102-5493	2XS 00						

Manufacturer's no. / Hella no.

Cross-Reference



O & K	Hella	O & K	Hella	Opel	Hella	Opel	Hella
4619240	2ZR 003 236-051	8464953	2AB 004 532-057	20 98 939	8GA 007 997-171	93177645	5DD 008 319-501
4619240	2ZR 003 236-057	8467037	1G5 120 510-001	20 98 946	8GS 007 949-101	93178633	1LG 270 370-331
0490772	8XS 113 389-001	8467158	9XR 854 840-001	223335666	2SD 002 582-021	93178634	1LG 270 370-341
0490775	2AA 001 200-131	8475319	1N4 002 608-021	223335666	2SD 002 582-027	93178771	9EL 160 468-011
0490776	2AA 001 200-141	8476344	2XS 955 031-001	24451030	1LG 270 370-331	93178772	9EL 160 467-011
049775	2AA 001 200-131	8482092	9EL 146 491-001	24451031	1LG 270 370-341	93183055	9EL 161 421-011
0505650	1G8 002 340-001	8482692	9EL 855 097-001	24 60 055	2SB 003 018-031	93183056	9EL 161 422-011
0511591	2BA 002 324-011	8485655	9EL 856 418-001	24 60 507	9EL 126 294-001	93190067	1LG 270 370-631
0511592	2BA 002 324-021	8488471	2RL 008 060-111	24 60 515	9EL 089 114-001	93190068	1LG 270 370-641
0524903	2BA 001 221-031	8488472	2RL 008 061-111	24610120	2SD 001 305-021	93190306	9EL 354 073-011
0524904	2BA 001 221-041	8519965	2SA 003 057-021	24610130	9EL 052 476-001	93190307	9EL 354 073-021
524951	2KA 003 389-061	8520062	2PF 003 057-041	24615070	8GD 002 084-131	99044500	8HG 006 294-031
524951	2KA 003 389-062	8520691	9EL 117 330-011	26 60 078	2SD 001 680-271	99049100	8GA 002 071-241
524951	2KA 003 389-068	0900585	8GS 002 296-111	26 60 079	2SD 001 680-281	99050000	8GP 002 095-121
0552314	2BA 002 652-121	0900251	2JA 001 330-001	26600800	9EL 107 368-001	99073100	8GH 002 089-133
0552314	2BA 002 652-127	0902051	2JA 001 330-007	26600810	9EL 111 647-001	99120710	8GA 002 071-251
0552315	2BA 002 652-111	0933387	2JA 004 531-011	28605050	8GH 002 090-133	E-X0531306AA	6ED 004 778-001
0552315	2BA 002 652-117	0933953	1G8 002 340-011	28 61030	2BA 003 022-021	J03040078	2DA 003 014-031
0559299	8GH 002 090-133	937501	2BA 001 423-087	28615040	8GA 002 083-131	J03040078	2DA 003 014-037
0576126	2PF 001 650-001	937501	2SB 001 423-097	29700301	2XS 005 020-021	J03040080	2PF 001 650-001
0576426	2SE 002 578-701	9944197	9GT 067 751-001	30 40 041	2RL 008 064-101	J03040091	2SA 003 014-051
0576426	2SE 002 578-707	0944198	1S5 003 178-431	30749100	8JA 004 667-001	PR0531060	2ZR 003 315-041
576427	2BA 002 652-101	0944924	8GJ 002 525-251	34 59 065	9FF 085 642-001	PR0531975	2KA 003 389-061
576427	2BA 002 652-107	0945429	2AA 001 200-041	3470100	8GA 002 083-251	PR0531975	2KA 003 389-062
0590880	2BA 003 014-111	0095025	8JA 001 909-011	34 78 011	2AA 001 200-001	PR0531975	2KA 003 389-068
0591342	2SB 003 014-151	970097	2PF 001 259-631	39 00 017	2BA 003 236-021	PR0532202	2SD 003 182-051
0591900	2ZR 001 193-011	0971531	1G5 003 241-021	39 00 017	2BA 003 236-027	PR0532202	2SD 003 182-051
0597009	2SD 002 776-231	0971532	2KA 003 389-061	4027100	8GA 002 072-121	PRA003110	8RA 002 016-121
0597009	2SD 002 776-237	0971532	2KA 003 389-062	40 27 500	8GA 002 083-131	PRF866678	2XW 003 146-001
0597064	2SD 002 776-241	0971532	2KA 003 389-068	40936	2RL 008 061-101	PRK000489	2KA 005 049-011
0597064	2SD 002 776-247	0987118	8HG 002 365-001	41101	2JA 007 373-001	PRK000489	2KA 005 049-017
597484	8GP 002 095-121	0987253	2XW 003 146-001	41 23 200	8GD 002 084-131	PRK000489	8RA 004 412-001
598034	2SA 003 014-051	BER511591	2BA 002 324-011	41 23 600	8GD 002 072-241	PRK000588	2XW 003 146-001
0598671	2SW 003 014-131	BER511592	2BA 002 324-021	41 50 200	9EL 052 476-001	PRK000607	2AA 003 257-041
0064616	8GD 002 088-251			41 59 800	2SD 001 305-021	PRK000607	2AA 003 257-042
6914613	9EL 964 536-001			42272	2XD 008 997-001	PRK000607	2BA 002 324-001
7000-448	1N4 005 750-001			43093	1GA 996 142-041	PRK000607	2SD 001 699-061
0718942	2SD 001 685-211			43175700	8GD 002 084-131	PRK000607	2SD 001 699-511
0718942	2SD 001 685-218			43175800	8GA 002 083-131	PRX002669	1TA 003 570-101
0726334	8RL 002 009-021			43191200	8GJ 002 525-131	PRX002669	1TA 003 570-001
0726357	1G8 132 233-011			43206500	8GA 002 083-251	V01049500	2SB 003 018-031
0726532	8GP 002 095-241			43206600	1TA 003 570-101	V03015300	1G5 003 241-081
7300981	9EL 856 416-001			43846	9XB 167 882-001	V04027900	2AA 001 200-031
0760569	2ZR 003 014-091			44001600	9EL 052 476-001	V04029400	2AA 001 200-011
0763043	9ES 106 588-001			44012200	2SD 001 305-021	V04029400	2AA 001 200-012
7723-462	1VB 005 444-037			44061	2JA 343 720-121	V04159800	1XD 001 305-021
7751280	8HG 006 294-021			44 594	9MM 863 164-051	V04221200	2SD 001 619-001
7803855	2AB 001 208-001			60-0288	2SY 003 014-121	V04226800	2SD 001 619-001
8000013	8GM 002 091-261			60 35 200	2SA 003 014-051	V06028800	2SW 003 014-131
8002612	9EL 092 435-011			60 56 400	2SE 004 623-001	V06035200	2SA 003 014-051
8003720	2BE 002 582-031			60 56 400	2SE 004 623-007	V07000200	2ZR 003 315-041
8003833	2KA 001 386-231			62 07 044	6NM 007 878-351	V07000200	8RA 002 010-011
8003954	2SD 001 686-101			62 23 151	9EL 143 579-021	V07000700	2KA 001 386-231
8005804	9EL 112 744-001			62 23 152	9EL 143 580-021	V08092200	1TA 003 570-101
8006504	9EL 102 240-031			62 35 086	5DD 008 319-501	V23660340	2SW 003 014-131
8011905	8RA 003 326-011			67 10 010	1NA 009 029-011	V24605130	1G5 003 241-021
8011905	8RA 003 326-017			67 10 011	1NA 009 033-011	V24610120	2SD 001 305-021
8011905	8RA 003 326-041			67 10 012	1NA 009 029-021	V26600200	8RA 002 015-021
8011905	8RA 003 326-047			67 10 014	1NA 009 033-021	V26600610	1X0 001 515-021
8063931	2BA 001 248-001			67 10 039	1NA 010 503-011	V26600780	2SD 001 680-271
8110264	8RA 002 014-832			67 10 040	1NA 010 503-021	V26600790	9EL 001 680-281
8110307	2SD 003 182-051			80 20 100	9EL 074 484-031	V26600810	9EL 111 647-001
8110307	2SD 003 182-057			80 41 600	8GA 002 074-121	V26600820	2BA 003 014-011
8110330	2SD 003 182-061			80 43 000	8GD 002 078-121	V27600050	2SD 001 685-211
8110330	2SD 003 182-067			89 83 807	2KA 001 622-001	V27600050	2SD 001 685-218
8110485	1GB 006 213-101			90009587	2AA 003 257-041	V276005030	2KA 001 386-281
8110485	1GB 006 213-107			90009587	2AA 003 257-042	V28605420	8GH 002 090-133
8110503	9EL 118 614-011			90016718	2NE 002 985-001	V28605450	8SK 003 567-321
81305004160	8PA 007 732-013			90017822	2KA 001 386-281	V28610250	2BA 001 227-201
81344000160	9EV 857 067-011			90019231	2JA 001 346-011	V28610300	2BA 003 022-021
8200961	2SD 002 582-021			90019235	3AG 003 399-081	V29615040	8RA 002 016-121
8200961	2SD 002 582-027			90019237	6ZE 001 759-051	V29700300	8RA 002 014-101
8200962	2SD 002 582-011			90033942	2JA 001 330-031	V29700301	2X5 005 020-021
8200962	2SD 002 582-017			90053687	9BH 116 966-011	V44012200	2SD 001 305-021
8200963	9EL 112 743-001			90141523	2BA 003 022-021	V44022500	2SE 002 578-701
8200964	9EL 112 741-001			90141524	2AA 003 257-031	V44022500	2SE 002 578-707
8203698	8GP 003 594-141			90188655	2BA 001 227-211	V44029700	2BA 001 227-201
0082756	2SA 001 240-331			90188724	6ED 004 778-001	V46019400	1X0 001 515-021
0082849	2SD 001 305-021			90271592	2BA 004 532-011	V46021300	2SW 003 014-131
8302874	4AZ 003 787-021			90271592	2AB 004 532-021	V46059200	2BA 003 014-011
8412648	2SB 003 018-031			90295524	2AB 004 532-001	V46061300	2BA 003 014-111
8412656	2SD 001 693-011			90349849	2JA 001 364-001	V46063500	2ZR 003 014-091
8412667	2SD 001 699-061			90369131	8HG 854 516-001	V47001800	8RA 002 015-031
8412672	2SD 001 699-511			90398690	8JA 003 526-001	V47001900	8RA 003 503-001
8412674	2BA 003 022-001			90457812	6NM 007 282-641	V99120130	2AA 001 200-001
8412675	2SE 001 699-071			90485075	9GD 856 863-001	V99120290	8HG 002 365-001
8412692	2BA 003 734-061			90487570	1LG 006 920-231	V99120380	2AA 001 200-011
8412695	2BE 003 014-251			90487572	1LG 006 920-241	V99120380	2AA 001 200-012
8412695	2BE 003 014-257			90487918	9GD 858 086-001		
8412748	1G5 003 241-071			90492832	6NM 007 282-641		
8413050	2PF 001 648-161			90544283	2JA 001 364-001		
8413122	2JA 003 231-001			90590665	6NM 007 878-351		
8413704	9EL 110 910-001			91 20 067	2XW 007 146-001		
8413715	6ED 708 919-001			91 59 282	2BA 002 324-011		
8413762	9EL 854 912-001			91 59 293	2BA 002 324-021		
84353139	2BE 997 006-101			91 59 294	8GA 002 073-121		
8436822	9GT 074 132-001			91 93 413	1LL 009 020-231		
8436830	9EL 115 003-055			91 93 414	1LL 009 020-241		
8464232	2SA 001 634						

Manufacturer's no. / Hella no.

Cross-Reference



Renault	Hella	Saab	Hella	SAW	Hella	SAW	Hella
77 01 064 004	1L7 271 510-371	04 19 888	2KA 003 389-068	20.196-031	2TM 006 717-047	25.012-041	2KA 001 386-291
77 01 065 915	1LL 009 447-111	04 27 753	2BA 001 275-011	20.196-041	2PG 006 717-021	25.012-051	2KA 001 386-281
77 01 065 916	1LL 009 447-121	04 27 754	2BA 001 275-021	21.001-021	2SE 001 699-071	25.012-061	2KA 001 386-241
77 01 363 204	2XW 007 146-001	43 219	2SE 001 688-151	21.001-031	2SD 001 699-061	25.012-071	2KA 001 386-231
77 01 363 210	2XW 002 897-051	43 220	2SE 001 688-161	21.001-071	2SD 001 699-511	25.012-081	2KA 003 389-061
77 01 366 010	2BE 003 184-061	04 33 408	2ZR 001 240-351	21.002-011	2SE 001 688-151	25.087-161	2KA 998 523-001
77 01 366 011	2BE 003 184-051	43 81 448	9FF 085 642-001	21.002-031	2SD 001 688-141	25.122-001	2KA 997 122-001
77 01 366 012	2SE 002 578-701	04 51 756	2SA 003 734-121	21.002-051	2SE 001 688-161	26.027-091	2KA 997 027-051
77 01 366 012	2SE 002 578-707	04 51 757	2DA 003 734-011	21.002-071	2SD 001 688-171	80.085-001	2HJ 992 240-001
77 01 366 014	2ZR 002 694-001	04 53 090	8XS 113 389-001	21.003-001	2SE 002 582-071	80.085-011	8HG 002 240-011
77 03 097 178	8GA 006 841-121	49 111	9ES 106 588-001	21.003-011	2SD 002 582-021	80.085-061	8HG 002 240-021
77 11 130 004	9EL 144 132-001	509 319	2SD 001 688-141	21.003-051	2SD 002 582-011	80.085-081	8HG 002 240-031
77 11 130 005	9EL 144 131-001	57 947	2BA 003 022-021	21.005-021	2SE 997 005-011	80.089-001	8RA 002 020-002
77 11 130 006	9BG 142 247-021	61 225	2PG 002 727-021	21.005-031	2SD 997 005-021	80.090-001	8RA 002 014-031
77 11 130 007	9BG 142 248-021	61 226	9EL 114 400-015	21.006-001	2SE 997 006-011	80.090-011	8RA 002 014-041
77 11 130 023	9EL 144 131-001	63 047	9GD 100 140-001	21.006-011	2SD 997 006-021	80.090-021	8RA 002 014-051
77 11 130 024	9EL 144 132-001	06 33 415	8JA 001 909-001	21.006-221	2SD 997 006-031	80.091-001	8RA 003 326-001
82 00 127 702	2SK 008 659-101	656 187	8RA 002 023-021	21.007-001	2SE 002 776-211	80.091-011	8RA 003 326-021
82 00 127 704	2SK 008 659-091	06 961	2SA 003 057-021	21.007-011	2SD 002 776-231	80.091-021	8RA 003 326-011
82 00 142 687	2VP 008 736-121	70 693	2PS 004 361-001	21.007-081	2SE 003 182-011	80.095-001	8RA 002 015-001
82 00 142 688	2VP 008 736-111	70 693	2PS 004 361-007	21.007-091	2SD 003 182-061	80.106-001	8RA 004 412-021
82 00 417 349	2VP 982 006-011	75 069	2SB 001 240-311	21.007-121	2SE 002 776-221	80.106-011	8RA 004 412-011
82 00 417 351	2VP 982 006-021	95 58 040	9ES 133 384-005	21.007-131	2SD 002 776-231	80.106-021	8RA 004 412-001
82 00 474 327	2SK 009 467-121	97 819	9EL 092 435-011	21.007-141	2SD 003 182-021	80.141-001	8RA 002 016-111
82 00 474 328	2SK 009 467-111			21.007-151	2SD 003 182-051	80.141-011	8RA 002 016-101
82 00 493 374	2SK 008 659-111			21.008-001	2SE 997 008-001	80.143-001	8RA 002 023-011
82 00 493 375	2SK 008 659-121			21.008-041	2SE 002 578-701	80.143-011	8RA 002 023-011
82 00 629 471	1L7 271 510-331			21.009-101	2SE 001 686-142	80.143-021	8RA 002 023-021
82 00 629 472	1L7 271 510-341			21.009-111	2SD 001 686-101	90.001-011	9EL 109 139-001
82 00 629 487	1L7 271 510-371			21.010-101	2SE 001 685-201	90.002-011	9EL 092 435-011
82 00 629 492	1L7 271 510-381			21.010-111	2SD 001 685-211	90.003-001	9EL 116 844-001
83 08 133 787	9EL 113 928-001			21.010-121	2SE 001 685-221	90.003-011	9EL 112 741-001
00 09 333 870	2PF 001 638-011			21.010-131	2SD 001 685-231	90.003-021	9EL 112 741-001
00 09 333 871	2SA 001 638-021			21.017-121	2XS 005 639-001	90.003-051	9EL 112 743-001
				21.026-011	2TF 001 259-761	90.003-061	9EL 997 310-001
Renault V.I.	Hella			21.026-091	2ST 001 259-321	90.005-001	9EL 997 313-001
50 00 243 871	9EL 109 139-001			21.026-131	2SB 001 259-261	90.007-001	9EL 134 739-001
50 00 786 223	8RA 002 014-051			21.028-061	2SW 003 014-131	90.007-011	9EL 137 308-001
50 00 786 223	8RA 002 014-052			21.028-071	2SB 003 014-151	90.007-081	9EL 118 613-001
50 00 786 922	8HG 002 365-001			21.037-001	2ST 001 673-011	90.007-091	9EL 118 614-011
50 00 882 775	2NE 002 589-001			21.037-021	2SB 001 673-002	90.007-101	9EL 118 614-011
50 01 825 345	2XW 002 897-051			21.038-041	2SB 001 301-021	90.007-111	9EL 137 307-001
50 01 842 626	9XB 136 202-005			21.044-001	2SE 001 679-051	90.007-121	9EL 134 740-001
50 01 847 584	2VD 008 204-251			21.044-011	2SD 001 679-001	90.008-061	9EL 997 332-001
50 01 847 585	2VP 008 204-241			21.086-021	2SE 003 167-031	90.008-101	9EL 146 941-001
50 01 860 545	8GP 008 285-001			21.086-031	2SD 003 167-021	90.010-051	9EL 113 324-001
50 01 865 642	1F8 006 800-191			21.086-041	2SE 003 167-041	90.012-021	9BG 101 230-011
50 01 865 643	1F8 006 800-221			21.088-001	2SD 003 167-011	90.012-031	9BG 101 230-001
50 10 043 471	2AB 004 532-051			21.088-051	2SE 997 088-001	90.014-021	9EL 110 013-001
50 10 043 471	2AB 004 532-057			21.111-001	2SD 003 184-031	90.014-031	9EL 110 014-001
50 10 057 423	2XW 003 146-001			21.111-001	2SE 997 111-011	90.015-001	9EL 116 907-001
50 10 168 934	8RA 003 326-041			21.111-011	2SE 997 111-021	90.015-011	9EL 116 907-001
50 10 168 934	8RA 003 326-047			21.113-061	2VA 997 113-001	90.017-001	9EL 117 330-001
50 10 623 627	1LR 246 046-541			21.131-001	2SD 997 131-051	90.017-021	9EL 117 330-011
50 10 623 628	1LR 246 046-531			21.147-001	2SK 003 567-331	90.017-081	9EL 117 334-001
54 30 064 863	2XS 950 071-031			21.147-001	2SK 003 567-651	90.017-091	9EL 117 334-021
58 10 117 240	1FE 008 773-051			21.147-011	2SK 003 567-321	90.019-041	9EL 108 435-001
93 33 872	8HG 006 294-011			21.147-011	2SK 003 567-661	90.026-001	9EL 135 266-001
AM39599001	2RL 007 550-011			21.147-021	2SL 003 567-311	90.026-021	9EL 109 208-011
				21.147-061	2VP 003 567-111	90.026-041	9EL 088 150-001
Rubbolite	Hella			21.147-071	2VP 003 567-121	90.026-091	9EL 088 538-001
360MCE/07/00	2VP 008 204-101			21.167-001	2SE 007 547-011	90.027-201	9EL 997 387-001
360MCE/07/08	2VP 008 204-121			21.167-001	2SE 007 547-017	90.027-211	9EL 997 388-001
360MCE/08/01	2VD 008 204-111			21.167-011	2SE 007 547-021	90.027-291	9EL 113 928-001
360MCE/08/09	2VD 008 204-131			21.167-011	2SE 007 547-027	90.028-111	9EL 110 540-001
360SCE/08/00	2VD 008 204-141			21.167-031	2SE 007 547-041	90.028-121	9EL 110 542-001
360SCE/08/01	2VD 008 204-151			21.167-051	2SL 007 547-061	90.028-141	9EL 110 536-011
360SPS/01/00	2VP 008 204-041			21.167-051	2SL 007 547-067	90.028-151	9EL 110 536-011
360SPS/02/00	2VD 008 204-051			21.176-001	2SL 005 883-031	90.028-171	9EL 115 003-011
360SPS/07/00	2VP 008 204-061			21.176-011	2SK 005 883-021	90.028-181	9EL 115 003-035
360SPS/07/20	2VP 008 204-081			21.176-021	2SK 005 883-011	90.028-201	9EL 115 003-055
360SPS/07/22	2VP 008 204-081			21.176-031	2SL 005 883-041	90.030-061	9EL 119 977-001
360SPS/08/01	2VD 008 204-071			21.176-031	2VP 007 323-011	90.040-011	9EL 126 294-011
360SPS/08/31	2VD 008 204-091			21.197-001	2VD 007 323-021	90.087-001	9BG 121 587-031
360SPS/08/37	2VD 008 204-091			21.197-021	2VD 007 323-031	90.111-001	9EL 118 700-001
461SCE/08/30	2VD 008 205-021			21.197-021	2VD 007 323-041	90.111-011	9EL 997 451-001
461SCE/08/31	2VD 008 205-011			21.197-101	2VP 007 323-111	90.111-021	9EL 997 452-001
6311 A	9EL 152 889-001			21.197-111	2VP 007 323-121	90.111-031	9EL 118 705-001
80857 A	9EL 152 891-001			21.197-121	2VD 007 323-131	90.111-031	9EL 118 705-001
80873 A	9EL 152 884-001			21.197-131	2VD 007 323-141	90.113-001	9EL 997 453-001
THQ/06/00	2SD 001 685-211			22.003-021	2BE 002 582-031	90.131-001	9EL 997 459-001
				22.006-181	2BE 997 006-101	90.131-081	9EL 997 469-001
Saab	Hella			22.007-101	2BE 003 182-091	90.147-001	9EL 122 772-001
10 663	2ZR 001 193-011			22.007-111	2BE 003 182-101	90.147-021	9EL 122 689-021
12 76 7670	5DV 009 000-001			22.026-001	2BE 001 259-061	90.167-001	9EL 147 096-001
12 79 0580	9GH 156 191-001			22.028-091	2BE 003 014-251	90.167-011	9EL 147 097-001
12 79 0587	5DD 008 319-501			22.111-001	2BE 003 184-051	90.176-001	9EL 135 548-001
14 129	2ZR 002 694-001			22.111-011	2BE 003 184-061	90.196-001	9EL 141 135-031
15 09 319	2SD 001 688-141			22.131-011	2BE 997 131-081	90.197-001	9EL 141 135-021
15 761	2XD 003 022-061			23.030-051	2NE 003 315-011	92.147-001	9EL 146 887-001
17 247	9GD 102 484-001			23.033-001	2NE 001 423-011	92.147-011	9BG 130 945-001
19 888	2KA 003 389-061			23.056-011	2NE 002 985-001	93.115-111	9BG 130 946-001
19 888	2KA 003 389-062			24.027-201	2ZR 002 694-001		



Manufacturer's no. / Hella no.

Cross-Reference

Scania	Hella	Scania	Hella	Scania	Hella	Schmitz Cargobull	Hella
1 371 976	2VD 008 205-011	20 223 837	2PS 004 361-007	410 663	2ZR 001 193-011	1094479	2TM 008 645-061
1 371 977	2VD 008 205-021	20 223 838	2PS 003 748-121	414 129	2ZR 002 694-001	1094479	2TM 008 645-067
1 371 978	2VD 008 205-011	20 223 838	2PS 003 748-127	415 320	2KA 001 610-001	1094480	2XA 959 790-401
1 371 979	2VD 008 205-021	20 223 839	9EL 122 772-001	415 761	2XD 003 022-061	1094480	2XA 959 790-407
1 371 980	2VD 008 205-011	20 223 840	2PS 006 717-031	419 888	2KA 003 389-061	1096708	2ZR 997 506-391
1 371 981	2VD 008 205-021	20 223 840	2PS 006 717-032	419 888	2KA 003 389-062	1100	2PF 003 014-071
1 379 384	2KA 003 389-001	20 223 840	2PS 006 717-037	419 888	2KA 003 389-068	1112421	2PG 008 645-967
1 379 384	2KA 003 389-061	20 223 841	9EL 141 135-031	427 751	8XS 113 389-001	1112423	2PS 008 645-187
1 379 384	2KA 003 389-062	20 223 842	9EL 114 401-001	427 753	2BA 001 275-011	1112424	2PS 008 645-497
1 379 384	2KA 003 389-068	20 223 848	8KW 701 235-033	427 754	2BA 001 275-021	1115	2BA 003 022-021
1 380 819	9EL 152 864-001	20 223 851	2XS 005 020-001	433 408	2ZR 001 240-351	1128	2ZR 003 236-051
138 5406	9DE 145 675-011	20 223 851	2XS 005 020-002	433 565	9EL 101 899-001	1128	2ZR 003 236-057
138 5407	9DE 145 676-011	20 223 851	2XS 005 020-003	433 566	9EL 101 900-001	1133932	5DS 009 552-001
1 385 410	9EL 145 103-011	20 223 852	2KA 001 386-231	440 354	8RA 003 734-101	1144	2SA 003 057-021
1 386 271	2VD 008 204-141	20 223 853	2XS 005 020-021	451 756	2SA 003 734-121	1149	8GM 002 091-251
1 386 272	2VD 008 204-151	20 223 854	9EL 109 139-001	451 757	2DA 003 734-011	1150	8JA 001 925-001
1 387 155	9EL 145 104-011	20 223 856	2SK 003 567-331	453 090	8XS 113 389-001	1156	2JA 001 364-001
1 387 877	2VD 008 205-011	20 223 857	1F8 148 131-011	467 493	8RL 002 009-011	116060	2JA 004 531-011
1 387 878	2VD 008 205-021	20 223 858	2RL 008 060-111	474 408	2BA 005 603-011	116062	2JA 004 531-001
1 414 366	2VD 008 205-011	20 223 859	9EL 146 491-001	474 408	2BA 005 603-017	116070	1GA 005 060-041
1 414 367	2VD 008 205-021	20 223 860	9EL 147 096-031	474 409	2DA 005 603-031	116072	1G8 002 340-001
1 414 368	2VD 008 205-011	20 223 861	2SE 007 547-021	474 409	2DA 005 603-037	116081	8GH 002 090-251
1 414 369	2VD 008 205-021	20 223 861	2SE 007 547-027	474 410	2SA 005 603-021	116081	8GH 002 090-253
1 436 867	2VD 008 205-011	20 223 862	2KA 003 389-001	474 410	2SA 005 603-027	1196	9EL 852 820-001
1 436 868	2VD 008 205-021	20 223 863	2PF 001 259-631	474 411	2ZR 005 603-061	1203	8GP 002 066-241
1 450 245	1NL 007 186-407	20 223 864	2PF 003 057-001	474 411	2ZR 005 603-067	1381	2XS 005 020-011
1 450 642	2XW 007 146-001	20 223 865	2SA 001 259-751	478 342	2PF 001 259-631	1381	2XS 005 020-017
1 455 634	2DA 959 071-737	20 223 865	2SA 001 259-757	0 478 343	2NE 005 603-071	1464	1G5 003 241-081
146 7007	8KA 155 372-001	20 223 869	8JA 008 151-041	0 478 343	2NE 005 603-077	147478	8HG 006 294-021
1 472 724	2PF 964 295-021	20 223 878	2SD 001 686-101	478 344	2KA 001 378-041	147490	9GD 859 037-001
1 472 724	2PF 964 295-027	20 223 879	2ZR 001 423-001	478 345	8RA 002 014-081	1501	8HG 005 436-011
1 479 891	2BA 008 221-041	20 223 880	9EL 862 141-001	478 346	2SA 001 259-751	16062	9GD 856 863-001
1 479 891	2BA 008 221-047	20 223 881	2DA 001 423-077	478 346	2SA 001 259-757	16070	2JA 004 531-001
1 483 010	1NL 008 090-031	20 223 882	1GA 996 083-011	478 349	2PG 962 964-051	16070	1GA 005 060-041
1 483 010	1NL 008 090-037	20 223 883	1GA 006 991-031	478 349	2PG 962 964-057	16071	1G5 003 241-081
1 509 319	2SD 001 688-141	20 223 884	1GA 007 506-011	478 349	2PS 962 964-012	16081	8GH 002 090-133
1 732 515	8KA 155 372-001	20 223 884	1GA 007 506-012	478 349	2PS 962 964-018	1619	2AB 004 532-051
0 173 546	8GP 002 067-241	20 223 885	2PF 959 590-411	484 769	2SA 962 964-091	1619	2AB 004 532-057
177 942	8JA 001 914-011	20 223 885	2PF 959 590-417	484 770	2PF 962 964-071	1748	2KA 001 389-101
182 777	9ES 084 374-001	20 223 886	1GA 007 506-081	484 771	2BA 001 221-031	1748	2KA 006 896-001
183 202	9DE 089 102-011	20 223 887	8GJ 002 525-131	484 772	2BA 001 221-041	1751	2KA 006 896-007
197 819	9EL 092 435-011	20 223 889	2XA 959 790-411	487 70	2PF 962 964-071	1751	2KA 998 523-001
20 011 000	2XW 003 146-001	20 223 891	2BA 008 260-001	488 421	9GT 963 129-001	182991	8RA 003 326-011
20 011 000	2XW 007 146-001	20 223 891	2BA 008 260-007	490 896	9GD 963 281-001	182991	8RA 003 326-017
20 011 005	2XW 002 897-051	20 223 893	2BA 002 324-001	492 205	2KA 001 378-041	183100	9EL 132 215-001
20 044 850	2ZR 003 236-051	20 223 896	2KA 003 389-211	561 225	2PG 002 727-021	188003	2BM 006 692-017
20 044 850	2ZR 003 236-057	20 223 896	2KA 003 389-217	561 226	9EL 114 400-015	188003	2BM 006 692-021
20 044 855	2NE 003 236-001	20 223 898	2PS 963 639-207	583 086	2JA 004 531-011	188003	2BM 006 692-027
20 044 855	2NE 003 236-008	20 223 899	2TM 963 639-317	618 261	2VD 008 204-151	188007	2BM 006 692-011
20 044 864	2PS 006 717-031	20 223 906	9FT 861 790-011	618 860	2ZR 001 240-351	188007	2BM 006 692-017
20 044 864	2PS 006 717-032	20 223 907	2RL 007 900-211	619 241	2KA 001 386-241	188033	2XS 005 020-067
20 044 864	2PS 006 717-037	20 223 908	9EL 950 315-031	619 241	2KA 001 386-281	199023	8MM 859 358-801
2 005 228	2PF 959 570-411	20 223 909	2VP 008 789-051	619 241	2KA 001 386-291	199440	6ZE 001 759-071
2 005 228	2PF 959 570-417	20 223 911	2PG 962 964-041	629 515	2SA 001 240-331	1-FZELEK0069	2XS 005 020-011
2 022 3030	2TJ 001 633-211	20 223 913	2PS 003 748-161	633 415	8JA 001 909-001	1-FZELEK0069	2XS 005 020-017
20 223 032	9EL 950 315-061	20 223 913	2PS 003 748-167	639 096	9EL 113 928-001	1-FZELEK0071	2XS 955 031-001
20 223 034	8GD 002 078-241	20 223 914	2XS 955 031-001	639 267	9EL 108 651-001	1-FZELEK0072	2XS 950 071-031
20 223 037	2PF 003 389-037	20 223 918	2RL 008 061-111	656 187	8RA 002 023-021	1-FZELEK0073	2JA 003 231-001
20 223 038	2XS 008 078-001	20 223 920	1F8 007 560-311	663 046	2SA 001 638-021	1-FZELEK0081	2SL 003 567-311
20 223 038	2XS 008 078-007	20 223 923	2BA 007 135-001	675 069	2SB 001 240-311	1-FZELEK0083	2KA 001 386-281
20 223 450	2ZR 005 860-151	20 223 925	2BA 007 135-011	692 470	2JA 001 330-001	1-FZELEK0086	8RA 002 020-001
20 223 500	2ZR 997 506-391	20 223 926	2PS 340 001-011	692 470	2JA 001 330-007	1-FZELEK0086	8RA 002 020-002
20 223 550	2ZR 005 700-191	20 223 929	9XX 340 220-011	715 725	9FF 042 509-001	1-FZELEK0086	8RA 002 020-003
20 223 576	2VD 008 789-011	20 223 933	2SL 003 567-311			1-FZELEK0087	8RA 003 326-041
20 223 577	2VP 008 789-021	20223934	2JA 007 372-041			1-FZELEK0087	8RA 003 326-047
20 223 579	2PS 008 645-001	20 223 943	2SK 007 567-651			1-FZELEK0100	8GA 002 071-251
20 223 579	2PS 008 645-007	20 223 944	8KA 950 073-001			1-FZELEK0100	8GM 002 092-241
20 223 587	2BE 002 582-031	20 223 950	1F8 006 800-221			1-FZELEK0120	2PF 003 389-037
20223590	2PF 959 590-407	20 223 951	1F8 006 800-321			1-FZELEK0124	8GM 002 091-241
20223590	2PF 959 590-407	20 223 951	2SK 003 567-661			1-FZELEK0133	8GP 002 068-241
20 223 594	1GM 996 136-101	20 223 970	2RL 008 181-111			1-FZELEK0167	8GH 002 090-251
20 223 603	2PG 003 748-151	20 223 971	2SD 003 167-021			1-FZELEK0167	1G3 005 760-001
20 223 604	2VD 008 204-071	20 223 974	2RL 007 900-611			1-FZELEK0200	8GH 002 090-253
20 223 610	2SA 006 717-001	2 022 398 0	9XD 857 445-801			1-FZELEK0211	1G3 005 760-001
20 223 610	2SA 006 717-007	2 022 398 2	1FE 006 300-001			1-FZELEK0211	2NE 001 423-011
20 223 791	2NE 001 423-011	20 223 985	9EL 134 296-041			1-FZELEK0366	1GB 006 213-101
20 223 792	2XS 007 841-021	20 223 991	8GS 007 949-101			1-FZELEK0366	1GB 006 213-107
20 223 792	2XS 007 841-027	20 223 992	1K0 008 191-041			1-FZELEK0423	2XS 005 020-067
20 223 793	2BM 008 355-001	20 223 992	1K0 008 191-047			1-FZELEK0432	1F8 002 748-161
20 223 793	2BM 008 355-007	20 223 993	8GH 007 157-241			1-FZELEK0481	2PS 003 748-167
20 223 797	2SK 003 567-321	217 247	9GD 102 484-001			1-FZELEK0481	1FD 005 700-051
20 223 798	9EL 150 966-001	218 412	2AB 001 208-001			1-FZELEK0496	1GD 003 590-701
20 223 799	1F8 007 560-321	225 552	2ZR 001 423-001			1-FZELEK0498	2SD 003 167-021
20 223 801	9GH 152 654-007	233 203	2PS 002 727-001			1-FZELEK0501	8GA 002 073-241
20 223 807	8JD 008 151-011	241 227	2SE 001 685-221			1-INBEMA0009	8HG 002 365-001
20 223 810	2XS 008 479-051	241 227	2SE 001 685-227			2011	8GP 002 066-121
20 223 810	2XS 008 479-057	243 219	2SE 001 688-151			2309	2AA 001 204-011
20 223 812	9XR 855 975-001	243 220	2SE 001 688-161			2407	8JA 001 526-001
20 223 814	2RL 007 337-031	245 593	9EL 113 324-001				

Manufacturer's no. / Hella no.

Cross-Reference



Schmitz Cargobull	Hella	Schmitz Cargobull	Hella	Schmitz Cargobull	Hella	Schmitz Cargobull	Hella
060001	1GD 003 590-701	061309	8GM 002 091-141	063748	2XS 955 031-001	S060827	2KA 003 389-068
060050	2JA 004 531-001	061312	8GM 002 091-251	063834	8GA 002 071-121	8R06070	8RA 004 412-001
060050	2JA 004 531-011	061317	8GD 002 088-131	063854	2PF 959 590-411	S061361	8GA 002 071-241
060050	2JA 007 372-011	061320	8GH 002 090-133	063854	2PF 959 590-417	S061806	8RA 004 412-011
060056	2SD 001 693-011	061321	8GH 002 090-251	063889	2PF 959 590-437		
060071	2RL 008 060-111	061321	8GH 002 090-253	063947	2PF 959 590-401		
060075	2SK 003 567-651	061323	8GP 002 068-241	063947	2PF 959 590-407		
060133	8JB 001 933-031	061325	8GP 002 066-121	063973	2VA 997 113-001		
060182	2XS 005 020-011	061326	8GP 002 068-121	064043	2DA 959 071-737		
060182	2XS 005 020-017	061329	8GP 002 095-121	64143	1G3 996 001-131		
060453	8HG 002 240-021	061330	8GP 002 095-241	064180	2VD 007 323-031	1M 594 010 701 C	1M 594 511 101 C
060503	2SE 003 167-031	061341	8GA 002 071-121	064541	9EL 146 838-001	1M 594 511 201 C	1P0 945 112 A
060515	2SE 001 685-201	061343	8GA 002 071-131	060646	2BA 003 022-021	1P0 945 112 A	1P0 945 112 A
060515	2SE 001 685-221	061348	8GA 002 072-121	064726	2NE 003 315-011	1P0 945 112 A	1P0 945 112 A
060515	2SE 001 685-227	061359	8GP 002 066-241	064815	2PG 340 000-121	5P0 941 700 A	5P0 941 703
060516	2SD 001 685-211	061360	8GA 002 072-241	064816	2PS 340 000-051	5P0 941 704	5P0 941 704
060516	2SD 001 685-218	061360	8GP 002 068-241	065081	2TM 963 639-317	5P8 945 107 A	5P8 945 107 C
060516	2SD 001 685-231	061361	8GA 002 071-241	065121	1G4 997 033-011	5P8 945 107 C	5P8 945 108 A
060516	2SD 001 685-232	061361	8GA 002 071-261	65813	8GH 002 089-251	5P8 945 108 A	5P8 945 108 C
060520	2SD 001 699-061	061366	8GM 002 091-241	65813	8GH 002 089-253	5P8 945 111	5P8 945 111 A
060521	2SE 001 699-071	061368	8GA 002 073-241	066404	2NE 001 423-011	5P8 945 112	5P8 945 112 A
060522	9EL 107 368-001	061368	8GA 002 073-251	066414	2ZR 001 423-001	6H0 941 699	6H0 941 699
060523	9EL 111 647-001	061374	8GA 002 083-251	066416	2ZR 004 542-001	6H0 941 700	6H0 941 701 A
060524	9EL 109 139-001	061375	8GD 002 088-251	066417	2ZR 003 236-051	6H0 941 701 A	6H0 941 701 A
060526	9EL 147 747-001	061376	8GA 002 071-271	066417	2ZR 003 236-057	6H0 941 702 A	6H0 941 702 A
060528	9EL 102 240-031	061378	8GA 002 071-251	066602	2TJ 001 633-211	6K6 945 107	6K6 945 107 B
060531	9ES 106 588-001	061381	8GJ 002 525-251	066603	2PF 001 648-161	6K6 945 107 C	6K6 945 108 B
060532	9EL 119 544-111	061382	8GH 002 090-251	066608	2PF 001 259-761	6K6 945 108 C	6K6 945 111 G
060538	9EL 122 772-001	614299	1GA 007 506-081	066611	2PF 001 259-631	6K6 945 111 G	6K6 945 112 A
060550	2SD 004 431-011	061458	2SD 001 688-141	066612	2SA 001 259-751	6L0 941 703	6L0 941 703
060552	2SD 003 167-011	061470	9EL 113 324-001	066616	2SA 001 259-757	6L5 945 111	6L5 945 111
060553	2SD 003 167-021	061471	8GA 002 071-251	066622	2XS 950 071-031	6N0 941 699	6N0 941 699 A
060558	2NE 003 236-001	061591	2XW 002 897-041	066627	2TM 003 748-011	6N0 941 699 A	6N0 941 699 A
060558	2NE 003 236-008	061591	2XW 002 897-051	066634	2PG 003 057-011	6N0 941 700 A	6N0 941 700 A
060561	2SK 003 567-321	061601	2PF 003 389-037	066713	2KA 001 386-231	7M0 945 095 F	7M0 945 096 F
060562	2SK 003 567-331	061611	2PF 003 014-071	000674	2KA 001 386-281	7M3 945 095 F	7M3 945 095 F
06 05 63	2SD 001 699-511	061625	2XS 005 020-017	00674541	8RA 002 016-111	7M3 945 096 G	7M3 945 096 G
060565	2SD 003 167-011	061625	2XS 005 020-017	006887	9EL 146 838-001	7M3 945 096 J	7M3 945 096 J
060566	2SD 003 167-021	061639	2VD 005 300-551	7190	9EL 092 435-011		
060576	2SD 001 688-141	061651	8GP 003 594-251	7226	8RA 002 010-011		
060576	2SE 001 688-161	061662	2SK 005 883-021	7385	2AB 004 532-001		
060577	2SD 001 688-171	061663	2SK 005 883-011	740021	9MK 860 255-001		
060578	2SE 001 688-151	061694	2VP 003 567-111	740022	2SD 001 685-232		
060578	2SL 003 567-311	061695	2VP 003 567-121	740022	2NE 001 423-011		
060594	2SD 001 680-271	061695	2VP 003 567-127	740305	2XS 950 071-031		
060595	2SD 001 680-281	061717	2PS 004 361-001	740599	2KA 003 389-061		
060704	8RA 002 020-001	061717	2PS 004 361-007	740599	2KA 003 389-062		
060704	8RA 002 020-002	061723	2KA 001 386-281	740599	2KA 003 389-068		
060704	8RA 002 020-003	061724	2PG 004 361-011	740724	9ZR 001 423-001		
060704	8RA 002 020-051	061724	2PG 004 361-017	75 06 05	2ZR 074 132-001		
060707	8RA 002 016-101	061727	2SE 003 167-031	7711	2AA 001 204-001		
060708	8RA 002 014-051	061803	8HG 002 240-031	8-0313852	8HG 006 294-021		
060708	8RA 002 014-052	061805	8HG 002 240-001	8482092	9EL 146 491-001		
060709	8RA 003 326-001	061806	8RA 004 412-011	887237	2PS 008 645-001		
060709	8RA 003 326-002	061807	8RA 003 326-041	887237	2PS 008 645-007		
060710	8RA 002 014-041	061807	8RA 003 326-047	980400	2SE 002 582-071		
060710	8RA 002 014-042	061817	2PS 006 717-061	980400	2TJ 001 633-211		
060712	8RA 003 326-041	061817	2PS 006 717-067	980400	8GH 002 857-241		
060712	8RA 003 326-047	061853	2NE 002 589-001	980400	9EL 109 139-001		
060718	2PS 002 727-001	061866	8GM 002 091-241	980400	9EL 114 401-031		
060729	8HG 002 240-001	618834	2PS 340 001-011	980400	9EL 134 659-001		
060729	8HG 002 240-011	062091	2PS 003 748-161	980400	9EL 134 660-001		
060731	8RA 002 014-051	062091	2PS 003 748-167	980400X	9EL 114 401-031		
060731	8RA 002 014-052	062117	2VP 007 323-011	980776	1GA 005 060-041		
060767	2SE 003 167-041	062118	2VP 007 323-021	980776	1NL 005 566-051		
060827	2KA 003 389-061	062164	2VP 007 323-011	980776	1NL 005 566-061		
060827	2KA 003 389-062	062165	2VP 007 323-021	980777	9XD 130 261-001		
060827	2KA 003 389-068	062191	1NE 002 537-201	980777	8GP 002 095-241		
060870	8RA 004 412-001	062244	2PS 962 964-012	980902	2SE 004 623-001		
060896	2XS 005 020-077	062244	2PS 962 964-018	980904	2SE 004 623-007		
060932	9GP 003 995-801	062276	2VD 007 500-111	980904	2NE 003 315-011		
060935	2BA 003 014-111	062286	2VB 004 887-011	980910	2ZR 003 315-041		
060939	8GP 002 067-241	062287	2VP 004 887-021	980924	2JA 003 354-001		
060940	2XS 005 020-021	062374	2SK 003 567-331	980950	2JA 001 330-001		
060941	9GT 005 166-001	062374	2SK 003 567-651	980950	2JA 001 330-007		
060946	1NE 002 537-301	062375	2SK 003 567-661	980967	8JA 001 915-001		
060947	8HG 002 365-001	062462	2SD 004 431-011	BS11194240001	1ND 005 700-061		
060960	2XL 004 762-001	062579	2BA 007 135-001	BS11852480001	2SE 002 578-701		
060973	2SD 003 184-031	062672	2AA 003 257-041	BS11852480001	2SE 002 578-707		
060973	2SD 003 184-037	062672	2AA 003 257-042	BS11982330001	1GA 006 991-031		
060974	2SD 003 184-047	062761	2VP 007 907-031	EL0005-0020	8HG 006 294-051		
060974	2SD 003 184-047	062761	2VP 007 907-037	EL0005-0045	8JS 711 687-821		
060976	2PF 006 717-011	062762	2VP 007 907-041	EL0006-0026	8HG 006 294-021		
060977	2PS 006 717-031	062762	2VP 007 907-047	EL0013-0001	8GA 002 073-121		
060977	2PS 006 717-037	062990	8HG 006 294-051	EL0013-0002	8GA 002 071-131		
060978	2SA 006 717-001	063001	2JA 001 335-011	EL0013-0003	8GA 002 071-121		
060978	2SA 006 717-007	063002	2JA 003 232-001	EL0013-0004	8GM 002 092-121		
060982	2PG 006 717-021	063020	2PS 340 000-011	ELO007-0001	2PS 340 000-011		
060982	2PG 006 717-027	063029	9EL 950 315-031	ELO007-0046	9EL 146 838-001		
060983	2PG 006 717-021	063030	9EL 950 315-061	ELO007-0057	1G3 005 760-211		
060983	2PG 006 717-027	063033	2PS 340 001-001	ELO007-0057	9XD 130 261-001		
060984	2BM 006 692-011	063083	2PS 340 001-011	ELO007-0062	9XD 130 261-001		
060984	2BM 006 692-017	063102	8JB 001 933-031	ELO007-0063	2PF 959 590-401		
061137	8KW 701 235-033	063104	9EL 101 353-001	ELO007-0102	2PF 959 590-407		
061160	8GD 002 078-241	063106	9EL 150 966-001	ELO007-0102	9EL 950 315-061		
061182	2BM 006 692-021	063107	9EL 150 965-001	ELO007-0103	9EL 950 315-031		
061182	2BM 006 692-027	063113	1GD 005 700-501	ELO013-0005	8GP 002 068-241		
061224	8HG 006 294-051	063118	1GD 005 700-501	ELO013-0006	8GP 002 078-241		
612791	1GA 005 060-001	063602	2XS 008 078-001	HWZ300-0047	8PE 008 932-001		
612792	9XD 130 261-001	063602	2XS 008 078-007	R 060 198	2PS 340 001-011		
061297	8GP 002 067-241	063633	8GA 002 073-121	S060561	2SK 003 567-321		
061301	8GP 002 067-241	063635	8GA 002 071-131	S060562	2SK 003 567-331		
061307	8GM 002 092-121	063636	8GM 002 092-121	S060827	2KA 003 389-061		
061308	8GM 002 091-131	063637	8GM 002 091-131	S060827	2KA 003 389-062		



Manufacturer's no. / Hella no.

Cross-Reference

Sisu	Hella	Skoda	Hella	Steinbock	Hella	Steyr	Hella
187-201-2597	2TM 004 361-021	098 788 189 A	9EL 246 201-011	520 30665	8GP 002 067-241	5.899.91.000.06.0	2ZR 003 014-091
187-201-2611	2PF 008 221-011	098 788 189 B	9EL 246 201-011	524 112	2ZR 002 985-261	5.899.91.000.18.0	2ZR 003 236-051
187-201-2627	2BA 008 805-051	098 788 190 A	9EL 246 202-011	525 535	2VP 006 040-111	5.899.91.000.18.0	2ZR 003 236-057
187-201-2627	2BA 008 805-057	098 788 213 A	9EL 246 151-021	525 536	2VP 006 040-117	5.899.91.004.03.0	2BE 002 582-021
187-201-2637	2PG 964 295-111	098 788 214 A	9EL 246 152-021	525 536	2VP 006 040-121	5.899.91.004.08.0	2BA 003 236-021
187-201-2637	2PG 964 295-117	098 788 219	2DA 007 428-001	525 681	2VP 006 040-127	5.899.91.004.08.0	2BA 003 236-027
187-201-2657	2BA 008 221-001	098 788 219	2DA 007 428-007	525 681	2VP 006 040-351	5.899.91.004.08.0	2KA 001 378-001
187-201-2657	2BA 008 221-007			525 682	2VP 006 040-357	5.899.91.004.08.0	2KA 001 622-001
187-205-0217	2BA 003 022-057			525 682	2VP 006 040-301	5.899.91.010.02.0	2SD 002 582-011
187-206-0072	2RL 008 061-111			079 39863	2VP 006 040-307	5.899.91.010.02.0	2SD 002 582-017
187-206-0156	2BA 003 022-021			850 06026	1GA 005 060-001	5.899.91.010.03.0	2SD 002 582-027
187-206-0221	2RL 008 181-111			087 24450	8RL 002 009-021	5.899.91.010.04.0	2SA 003 014-051
187-207-0011	2XW 003 146-001			088 82927	1GA 132 459-011	5.899.91.010.08.0	2SA 003 236-041
187-251-0910	9EL 110 014-001			089 28332	9EL 856 010-001	5.899.91.010.08.0	2SA 003 236-047
187-251-0911	9EL 110 013-001			987 4533	2SD 003 182-051	5.899.91.010.09.0	2DA 003 236-037
187-251-1210	9EL 115 003-055			987 4533	2SD 003 182-057	5.899.91.010.10.0	2NE 003 236-001
187-251-1300	9EL 108 435-001			988 3755	2VP 003 567-111	5.899.91.010.10.0	2NE 003 236-008
187-251-1510	9EL 115 830-001					5.899.91.012.13.0	8RL 002 009-011
187-251-1900	9EL 856 418-001					5.899.91.012.14.0	8RA 003 660-007
187-251-2250	9EL 862 141-001					5.900.05.800.58.0	2AA 001 200-141
187-281-0310	9GD 856 863-001					5.900.05.800.86.0	2AA 001 200-131
187-301-0187	2SD 001 685-231					5.900.05.800.87.0	2AA 001 200-151
187-301-0187	2SD 001 685-232					5.900.05.800.91.0	2AA 001 200-041
187-301-0277	2SE 001 685-221					5.920.00.125.71.0	9GH 096 532-001
187-301-0277	2SE 001 685-227					000 657 01 23	8HG 096 531-007
187-301-0287	2SD 001 685-231					6.805.80.119	6ED 004 778-011
187-301-0287	2SD 001 685-232					692.00.72.0701	9EL 854 912-001
187-301-0537	2KA 003 389-211					692.00.72.0740	9EL 856 418-001
187-301-0537	2KA 003 389-217					69200770123	9GT 074 132-001
187-301-0917	2PF 001 647-031					6.920.08.100.03	2SL 003 567-311
187-301-0917	2PF 001 647-033					69200810004	2SK 003 567-321
187-301-1151	2VP 007 323-121					69200810005	9GP 003 995-801
187-305-0357	2SA 961 167-011					692.00.81.0701	9EL 122 772-001
187-351-0600	9EL 113 324-001					7.004.85.004.0	2BA 002 324-001
187-351-1110	9EL 122 689-021					700.4.85.800.1	9EL 110 910-001
187-401-0117	2JA 001 330-001					7.11.85.013.0	2SD 001 686-101
187-401-0117	2JA 001 330-007					711.1.85.565.0	9EL 852 061-001
187-401-0851	2JA 007 372-011					7.121.93.507.0	2BA 003 014-011
187-408-0017	2AB 001 208-001					7.121.93.529.0	2KA 004 525-001
187-408-0021	2AB 004 532-051					7.141.85.225.9	2JA 004 531-011
187-408-0021	2AB 004 532-057					7.161.85.505.0	2KA 001 610-001
187-408-0031	2JA 004 192-001					7162850230	2SK 003 567-331
187-801-1661	2AA 001 200-151					716 285 02 40	2SK 003 567-321
187-801-1671	2AA 001 200-041					7162855110	9EL 122 772-001
187-908-0011	9XB 152 977-001					7.171.93.552.0	3AG 003 399-101
						7.211.85.539.1	8HG 096 531-007
						7.534.18.300.00	2XS 005 020-001
						7.534.18.300.00	2XS 005 020-002
						7.534.18.300.00	2XS 005 020-003
						7.581.85.001	1GA 007 506-011
						7.581.85.003	1GA 007 506-012
						7.581.85.003.0	2BA 002 652-101
						7.587.85.003.0	2BA 002 652-107
						7.587.85.003.0	2BA 002 652-107
						777 935 703	2PF 001 634-101
						8.227.20.007	8JA 001 914-011
						791.00.72.0036	8HG 002 365-001
						7.910.08.100.13.0	2NE 003 236-001
						7.910.08.100.13.0	2NE 003 236-008
						7.910.08.100.14	2ZR 003 236-051
						7.910.08.100.146	2ZR 003 236-057
						791.00.81.0703	2SD 003 167-521
						791.00.81.0703	9GD 087 883-355
						791.00.81.0704	9EL 119 544-111
						8.042.21.200.01.0	9EL 119 544-111
						8.125.10.260.84.1	8RA 002 010-011
						8.125.10.260.88	1NE 006 300-231
						81.25160.601.5	1NE 006 300-051
						81.25160.601.5	2PF 001 647-031
						81.25160.601.5	2PF 001 647-037
						8.125.22.561.82	2KA 003 389-081
						8.125.26.060.15	2PF 001 647-031
						8.125.26.060.62	2PF 001 647-037
						8.125.26.060.62	2XS 005 020-017
						8.125.26.060.62	2XS 005 020-041
						8.125.43.508.88	2XS 005 020-047
						8.166.80.460.12	8JA 003 526-001
						8.166.80.460.17	2XW 003 146-001
						8.525.10.360.01	2XW 002 897-051
						8.542.95.010.02	1GA 006 876-001
						0.861.11.01	8HG 002 240-031
						0.861.11.01	2BA 001 259-611
						93.72.0011	2BA 001 259-618
						990.00.72.0706	2ZR 002 985-081
						9.910.05.820.56	9DF 112 246-001
						000 997 32 86	8JA 003 526-001
						AD43-13776-BA	9GH 096 532-001
						SFT 7161855050	2KT 009 098-007
						X 842 070 990 013	2XA 001 610-001
						X 842 070 990 017	2TJ 001 633-211
						X 842 070 990 031	2SA 001 634-121
						X 860 533 935 209	2BA 002 324-001
						X 860 535 935 103	2BA 001 248-001
						X 860 535 935 719	9EL 110 918-001
						X 860 535 935 720	2BA 002 324-011
						X 860 582 935 311	2BA 002 324-021
						X 860 975 910 001	9GT 074 132-001
						X 861 019 040 701	2PF 001 634-101
						X 861 019 405 490	9EL 126 294-001
						X 861 041 060 350	2SD 001 679-001
						X 861 041 060 360	2ST 003 018-061
						X 880 000 920 645	2SB 003 018-031
							2BA 001 240-301

Manufacturer's no. / Hella no.

Cross-Reference



Steयर	Hella	Still	Hella	Still	Hella	Trifa	Hella
X 880 000 920 649	2SA 001 240-331	513989	8GA 002 073-241	7919564958	8GP 002 067-241	01607-87	8GH 007 157-951
X 880 000 922 260	2SB 001 259-631	516597	9FF 090 500-001	7919564970	8GM 002 091-251	1617	8GH 007 157-241
X 880 000 922 262	2PF 001 259-631	518289	8GA 002 071-251	7919564982	8GM 002 092-241	01617-51	8GH 007 157-931
X 880 001 106 732	9EL 110 910-001	518293	8GA 002 073-121	7919564985	8GA 006 841-121	1621	8GH 005 636-121
Still	Hella	518819	8HG 002 240-001	7919651010	2AB 004 532-011	1623	8GH 005 635-121
1000640	9EL 856 010-001	519565	2SY 003 014-121	8004902	2JA 007 372-011	1639	8GH 002 473-151
1001303	9EL 146 491-001	519566	2BA 003 014-011	8007454	8GA 002 073-241	01640	8GH 002 473-191
1001304	9EL 119 397-001	519699	8GH 002 089-133	8011488	8GA 002 072-241	1641	8GH 002 473-132
1001332	9EL 856 418-001	519845	2SA 003 014-051	8013147	9EL 088 150-001	1642	8GH 007 643-121
1019001	8GJ 002 525-251	520208	2SW 003 014-131	8013148	8GH 002 090-251	1644	8GH 008 417-012
011437	8GA 002 071-241	520288	2ZR 003 014-091	8013148	8GH 002 090-253	1645	8GH 002 857-121
012236	2BA 002 324-001	520580	2DA 003 014-031	8013159	2BA 001 259-611	1646	8GH 002 857-241
1273631915	9EL 136 819-031	520580	2DA 003 014-037	8013159	2BA 001 259-618	01655-50	8GH 002 089-921
1273631916	9EL 136 825-011	521604	8GA 002 071-241	8013165	2AA 001 200-011	1656	8GH 002 089-251
12782501124	2BA 003 022-001	521726	2JA 001 330-001	8013165	2AA 001 200-012	1659	8GH 002 090-251
013147	9EL 088 150-001	521726	2JA 001 330-007	8013175	8GP 002 095-241	1702	8GA 007 997-011
013150	8GM 002 091-251	521945	2ZR 003 030-171	8013184	8GM 002 091-241	1702	8GP 002 095-121
013159	2BA 001 259-611	521996	8GP 002 095-241	8014375	8JA 003 526-001	1703	8GP 938 026-001
013159	2BA 001 259-618	522086	8GH 002 089-251	8017052	1TA 003 570-101	1704	8GP 002 095-241
013161	8GA 002 074-241	522086	8GH 002 089-253	8401307	8GP 002 067-241	01705	8GA 007 997-181
013165	2AA 001 200-011	522579	2BE 003 185-031	8402128	2BA 001 277-011	1712	8GP 003 594-141
013165	2AA 001 200-012	522722	8GH 002 090-133	8406140	2AB 004 532-011	1724	8GP 003 594-241
013170	8GP 002 068-241	522980	1GD 003 590-701	916232	2BA 001 277-011	01725	8GA 008 901-241
013172	9EL 854 912-001	522981	8GH 002 090-251	916650	1GA 003 470-001	1732	8GP 003 594-121
013175	8GP 002 095-241	522981	8GH 002 090-253	923025	2JA 007 372-011	1734	8GP 003 594-251
013177	8GA 002 083-251	523034	8RA 002 023-021	924394	2BA 001 259-611	1781	8GA 008 892-002
013184	8GM 002 091-241	523541	2BE 003 014-251	924394	2BA 001 259-618	1791	8GD 008 893-002
013196	2AA 001 200-141	523541	2BE 003 014-257	924396	2AA 001 200-011	02002	8GS 007 949-101
001334	2SA 003 057-021	523626	4AZ 003 787-021	924396	2AA 001 200-012	02002-11-19-5001	8GS 007 949-101
001335	2PF 003 057-041	523778	2BA 003 014-111	924399	8GP 002 068-241	02004	8GS 007 001-121
139424	9EL 126 294-001	523895	8GP 002 067-241	924757	8JA 003 526-001	02004-11-19-5001	8GS 007 001-121
014375	8JA 003 526-001	523926	2ST 003 014-141	951923	2AB 004 532-011	02008	8GH 008 356-121
014376	8KW 701 235-033	523940	2BA 002 652-111	954445	8GP 002 067-241	02009	8GH 008 357-001
015204	2AB 004 532-021	523940	2BA 002 652-117	0009740247	2SD 343 130-137	02011	8GH 008 358-121
015206	2AB 001 208-001	523941	2BA 002 652-121	0009740248	2SD 343 130-147	02013-001	8GJ 008 837-121
015210	1G5 003 241-021	523941	2BA 002 652-127	0009740249	2SD 343 390-417	202	8GM 002 094-121
015214	1G3 005 760-001	523942	2XS 950 071-031	0009740300	1H5 998 502-002	02027	8GH 008 991-021
158039	8JA 001 921-102	523946	2SB 003 014-151	000 974 04 12	1GA 005 060-001	02028	8GH 008 991-031
0159639	2VA 006 040-071	524112	2ZR 002 985-261	000 974 04 12	1GA 998 522-011	204	8GM 002 092-121
0159639	2VA 006 040-077	524976	1TA 003 570-101	000 974 04 26	1G3 005 760-011	21122	8GP 002 067-261
0159641	2VP 006 040-121	525016	1GA 005 060-001	0009740435	1L3 002 850-068	21304	8GA 002 071-261
0159644	2VP 006 040-127	525016	1GA 998 522-011	000 974 04 49	1GA 007 506-001	21305	8GA 002 071-271
0159675	1L3 002 850-068	525302-	2SE 002 578-701	000 974 04 49	1GA 007 506-002	21381	8GA 002 073-251
0159678	9AG 084 320-005	525302-	2SE 002 578-707	000 974 04 49	1GA 007 506-007	21661	8GJ 002 525-301
0159678	2BA 008 221-001	525535	2VP 006 040-111	0009740602	2VA 006 040-071	21662	8GJ 002 525-281
161606	8GA 006 841-241	525535	2VP 006 040-117	0009740602	2VA 006 040-077	221	8GM 002 091-131
0163728	9EL 136 819-031	525536	2VP 006 040-121	0009740603	2VP 006 040-121	2706	8GA 007 997-011
163731	9FF 111 606-021	525536	2VP 006 040-127	0009740603	2VP 006 040-127	2714	8GA 007 997-021
170031	8GH 007 157-241	525681	2VP 006 040-351	000 974 10 00	2BA 002 652-101	02715	8GH 007 997-121
0170333	9EL 136 825-011	525681	2VP 006 040-357	000 974 10 00	2BA 002 652-107	02716	8GA 007 997-131
017051	2SB 001 673-002	525682	2VP 006 040-301	0009747505	8HG 990 003-001	02718	8GA 007 997-171
017052	1TA 003 570-101	525682	2VP 006 040-307	0009740114	8HG 006 294-041	2719	8GA 007 997-041
017139	8RA 002 015-031	526077	2SE 004 623-001	999025	8RA 002 014-081	2720	8GA 007 997-061
0174907	1GA 007 506-001	526078	2SE 004 623-007	999038	1GD 708 919-001	2721	8GA 007 997-001
0174907	1GA 007 506-002	526078	2ZR 003 315-041	999038	1GA 007 506-061	02722	8GA 007 997-141
0174907	1GA 007 506-007	526282	1TA 003 570-001	999039	9EL 110 918-001	02723	8GA 007 997-151
001770	8RA 002 014-051	526363	1G3 005 760-001	999039	1GA 007 506-011	2725	8GA 007 997-071
001770	8RA 002 014-052	526363	2SD 003 184-031	999039	1GA 007 506-012	2726	8GA 007 997-081
001771	8RA 002 014-041	526363	2SD 003 184-037	999040	2BA 002 652-101	02728	8GA 007 997-161
001771	8RA 002 014-042	526366	2SD 003 184-041	999042	2BA 002 652-107	2730	8GA 007 997-051
001780	8RA 003 326-011	526366	2SD 003 184-047	999042	8XS 113 389-001	2732	8GA 007 997-091
001780	8RA 003 326-017	526366	2ZR 006 609-081	999129	9EL 118 701-001	02733	8GA 007 997-211
002804	4AZ 003 787-021	526668	2ZR 006 609-087	999159	1GM 996 136-111	02734	8GA 007 997-221
0029741000	2BE 001 259-061	526668	8RA 002 014-081	300 588	8GA 007 997-231	02735	8GA 007 997-231
0029741001	2BA 008 221-001	526668	2SD 002 582-011	300 589	8GA 007 997-241	02736	8GA 007 997-241
0029741001	2BA 008 221-007	526669	2SD 002 582-017	394 267	8GA 007 997-251	02737	8GA 007 997-251
003193	2PF 001 259-631	526669	2SD 002 582-021	394 268	8GA 007 997-261	02740	8GA 007 997-261
003611	2BA 003 014-011	526786	8RA 004 412-021	397 472	8GA 007 997-272	2749	8GA 007 997-272
400518	2SD 001 693-011	526868	2SK 003 567-321	19883	8GA 007 997-191	02750	8GA 007 997-191
400519	9EL 950 315-031	526869	2SK 003 567-331	19883	8GA 002 071-121	02751	8GA 007 997-201
401307	8GP 002 067-241	527169	1G3 005 760-201	300242	8GA 002 071-131	304	8GA 002 071-121
401454	2AB 004 532-051	527169	1G3 005 760-207	TD400-19883-0000P	8GD 002 078-121	306	8GA 002 071-131
401454	2AB 004 532-057	527367	8RA 003 326-931	TD400-19883-0000P	8GD 002 078-241	3381	8GD 002 078-241
402128	2BA 001 277-011	527446	2JA 003 354-001	TD400-80242-0000P	8GD 004 772-121	3391	8GD 004 772-121
406107	1G4 003 470-001	527885	1GA 007 506-001		8GA 002 072-121	371	8GA 002 072-121
406140	2AB 004 532-011	527885	1GA 007 506-002		8GA 002 073-121	381	8GA 002 073-121
407288	1G3 005 760-001	527885	1GA 007 506-007		8GA 002 074-121	391	8GA 002 074-121
040865	2BA 001 227-201	527975	9GH 993 984-001		8GA 008 899-061	00401	8GA 008 899-061
040873	2BE 003 018-011	529489	2SE 998 530-061		8GA 008 899-121	00410	8GA 008 899-121
040881	2KA 001 386-281	529489	2SE 998 530-067		8GH 007 157-201	41607	8GH 007 157-201
040882	2BA 001 259-611	529762	2NE 003 315-011		8GH 007 643-171	41642	8GH 007 643-171
040882	2BA 001 259-618	0530214	8GA 002 074-241		8GJ 002 525-481	41661	8GJ 002 525-481
040904	8GM 002 091-131	531429	8XS 113 389-001		8GA 002 083-131	421	8GA 002 083-131
040905	8GM 002 091-251	532456	8GD 002 078-121		8GP 002 068-121	500	8GP 002 068-121
040906	8GP 002 067-121	532472	8GH 007 157-121		8GP 002 067-061	501	8GP 002 067-061
041258	2SB 001 673-002	534115	2SE 003 184-101		8GM 002 094-241	503	8GM 002 094-241
004275	8GM 002 092-241	534454	2SD 343 130-157		8GM 002 092-241	51607	8GM 002 092-241
428041	2SB 003 014-151	534455	2SD 343 130-167		8GP 002 067-121	51650	8GP 002 067-121
4478410	2JA 004 192-001	005519	2XS 950 071-031		8GM 002 091-251	51660	8GM 002 091-251
004540	2ZR 003 030-171	634743	1GA 007 506-431		8GM 002 091-141		



Manufacturer's no. / Hella no.

Cross-Reference

Trifa	Hella	Ulo	Hella	Valeo	Hella	Visteon	Hella
00091	8GA 007 997-901	376 11 70	2SE 002 514-171	068730	1N4 005 750-001	20-200-01046	1LL 010 203-041
91661	8GJ 002 525-341	376 32 25	9EL 129 519-001	068731	1N4 002 608-021	20-200-01048	1LL 010 201-041
00092	8GA 007 997-911	376 32 70	2SE 004 623-001	068739	1F4 002 608-001	20-200-01050	1LL 010 201-081
00093	8GA 007 997-921	376 32 70	2SE 004 623-001	085294	9EL 150 987-001	20-200-01053	1LL 010 201-121
Tungsgam	Hella	3765-01	9EL 115 830-001	085295	9EL 150 988-001	20-200-01054	1LL 010 201-161
1057	8GA 002 073-121	3766-01	8RA 002 016-111	085296	9EL 150 867-001	20-200-01056	1LL 010 201-201
1059	8GA 002 072-121	3766-02	8RA 002 016-101	085297	9EL 150 868-001	20-200-01058	1LL 010 201-241
1060	8GA 002 073-241	3766-05	8RA 002 016-121	085387	2BA 002 939-171	20-200-01064	1LF 354 025-121
1060HD	8GA 002 073-251	377 21 25	9EL 122 772-001	085388	9EL 116 771-031	20-200-01066	1ZL 010 541-081
1077	8GD 002 078-121	377 21 51	2SK 003 567-321	085390	9EL 141 701-001	20-200-01068	1LL 010 541-121
1078	8GD 002 078-241	378 21 25	9EL 122 689-021	085391	9EL 141 702-001	20-200-01070	1LF 010 541-041
1113	8GA 002 074-121	3819-02	9EL 122 689-021	085392	9EL 144 425-001	20-201-01002	1LL 010 199-041
1117	8GA 002 072-241	3821-02	9EL 122 772-001	085393	9EL 144 426-001	20-201-01004	1LG 354 023-031
1120	8GA 002 074-241	3825-05	2SK 003 567-321	085394	8XU 144 427-001	20-201-01006	1LG 354 023-071
1122	8GD 004 772-121	3825-06	2SL 003 567-311	085395	8XU 144 428-001	20-201-01014	1LF 010 197-031
1130	8GA 002 083-251	3825-08	2SK 003 567-331	085396	9EL 144 425-011	20-201-01016	1LJ 010 202-051
1215	8GA 002 083-131	388 02 29	9EL 146 372-001	085397	9EL 144 426-011	20-201-01018	1LL 010 202-071
1526	8GD 002 084-131	388 12 29	9EL 146 371-001	085398	8XU 144 429-001	20-201-01020	1LL 010 202-111
1735	8GD 002 084-251	3908-01	2XW 002 897-041	085399	8XU 144 430-001	20-201-01021	1LE 010 198-091
1931	8GD 002 088-131	3908-02	085404	085404	9EL 142 459-011	20-201-01023	1LE 010 198-051
1937	8GD 002 088-251	393 15 72	2SD 002 582-021	085405	9EL 142 460-011	20-201-01026	1LE 010 198-151
2619	8GA 002 071-121	393 16 72	2SD 002 582-011	085502	9HB 006 948-031	20-201-01030	1LG 354 024-071
2627	8GA 002 071-241	396 01 02	9EL 950 315-031	085503	9HB 006 948-041	20-201-01032	1LG 354 024-051
2627HD	8GA 002 071-121	396 30 50	2TJ 001 633-211	085522	9BG 142 247-021	20-201-01035	1LG 354 024-131
2641	8GA 002 071-131	399 00 50	2BA 001 259-611	085523	9BG 142 248-021	20-201-01037	1LG 010 196-031
2643	8GA 002 071-251	4092-01	8RA 003 503-001	085733	9EL 158 254-011	20-201-01042	1LL 354 027-051
2643HD	8GA 002 071-241	4651-04	8RA 003 326-001	085734	9EL 158 254-021	20-201-01044	1LL 354 027-091
2659	8GP 002 067-061	4651-05	8RA 003 326-021	085769	8KA 146 152-001	20-201-01046	1LL 010 203-031
2660	8GP 002 068-121	4651-06	8RA 003 326-011	085972	9EL 144 131-001	20-201-01048	1LL 010 201-031
2661	8GP 002 067-241	4651-07	8RA 003 326-031	085973	9EL 144 132-001	20-201-01050	1LL 010 201-071
2662	8GP 002 067-121	4651-08	8RA 003 326-051	085974	9EL 151 875-021	20-201-01053	1LL 010 201-111
2663	8GP 002 068-241	4651-09	8RA 003 326-041	085975	9EL 151 876-021	20-201-01054	1LL 010 201-151
2692	8GP 002 066-241	4886-01	8RL 002 009-021	086754	9BG 142 248-021	20-201-01056	1LL 010 201-191
2696	8GP 002 066-121	4886-03	8RL 002 009-011	086755	9BG 142 247-021	20-201-01058	1LL 010 201-231
2765	8GP 002 096-061	5030-01	8RA 002 014-081	086866	9EL 144 425-011	20-201-01064	1LF 354 025-111
50320	8GH 002 089-251	5105-01	8RA 002 023-001	086867	9EL 144 425-001	20-201-01066	1ZL 010 541-071
50350	8GH 002 090-251	5105-02	8RA 002 023-011	086868	9EL 144 426-011	20-201-01068	1LL 010 541-111
50410	8GH 002 857-121	5105-03	8RA 002 023-021	086869	9EL 144 426-001	20-201-01070	1LF 010 541-031
50420	8GH 002 857-241	511 25 71	8RA 004 412-021	086979	1LE 007 350-111	20-202-01002	1NA 010 205-011
5300	8GP 002 095-121	520 00 70	8RL 002 009-021	086980	1LE 007 350-121	20-202-01003	1NO 354 017-021
5301	8GP 002 095-241	520 02 70	8RL 002 009-011	087299	6NM 007 878-041	20-202-01004	1NO 354 016-021
5304	8GP 003 594-141	521 00 70	8RA 003 326-001	89092643	5DV 009 000-001	20-202-01005	1NO 354 013-021
5305	8GP 003 594-241	521 01 70	8RA 003 326-021	Vauxhall	Hella	20-202-01006	1NO 354 018-021
5307	8GP 003 594-121	521 02 70	8RA 003 326-011	1 222 355	9EL 354 073-011	20-202-01007	1NA 010 205-021
7546	8GM 002 092-121	521 60 71	8RA 003 326-031	1 222 356	9EL 354 073-021	20-203-01003	1NO 354 017-011
7552	8GM 002 092-241	521 61 71	8RA 003 326-051	24451030	1LG 270 370-331	20-203-01004	1NO 354 016-011
7576	8GM 002 091-131	521 62 71	8RA 003 326-041	90487570	2NE 002 985-001	20-203-01005	1NO 354 013-011
7580	8GM 002 091-251	528 00 71	8RA 003 503-001	90487572	1LG 006 920-231	20-203-01006	1NO 354 018-011
7593	8GM 002 091-121	537 00 70	8RA 002 020-001	90487572	1LG 006 920-241	20-204-01001	9EL 354 059-011
7595	8GM 002 091-241	5521-02	8HG 002 240-001	9120067	2XW 007 146-001	20-204-01002	9EL 354 072-011
Ulo	Hella	5521-04	8HG 002 240-011	9193413	1LL 009 020-231	20-204-01003	9EL 354 075-011
148 00 71	8RA 002 016-111	5521-06	8HG 002 240-021	9193414	1LL 009 020-241	20-204-01004	9EL 354 060-011
148 01 71	8RA 002 016-101	5521-08	8HG 002 240-031	93175325	1LG 007 640-631	20-204-01006	2BA 010 232-011
148 50 71	8RA 002 016-121	5694-01	9EL 129 763-001	93175325	1LG 007 640-641	20-205-01001	9EL 354 059-021
2620 03	9EL 146 373-001	5694-02	9EL 129 762-001	93175725	1LG 007 640-631	20-205-01002	9EL 354 072-021
2798 05	9EL 146 372-001	5695-01	9EL 129 763-021	93175725	1LG 007 640-641	20-205-01003	9EL 354 075-021
2798 06	9EL 146 371-001	5695-04	9EL 129 762-031	93177645	5DD 008 319-501	20-205-01004	9EL 354 060-021
2898-01	8RA 002 014-031	5720-06	2VP 004 686-121	93178633	1LG 270 370-331	20-205-01006	2BA 010 232-021
2898-03	8RA 002 014-041	5721-09	2VP 004 686-151	93178634	1LG 270 370-341	20-206-01001	9EL 354 056-001
2898-04	8RA 002 014-051	5721-12	2VD 007 500-111	93190306	9EL 354 073-011	20-206-01003	9EL 354 058-001
308 02 29	9EL 146 373-001	5724 12	2VD 007 500-221	93190307	9EL 354 073-021	20-207-01001	1NO 009 617-011
3135-01	2SD 001 693-011	5724 13	2VD 007 500-411	Signal	Hella	20-210-01001	9EL 354 061-021
3135-13	2SD 001 699-511	5724-14	2VP 007 500-421	167700	2VP 008 204-041	20-210-01002	9EL 354 057-021
3135-17	2SE 001 699-071	5725 01	2VD 005 300-551	167700	2VD 008 204-051	20-210-01004	9EL 171 556-031
3233-02	2SE 002 514-171	5865-01	2SE 003 167-031	168010	2VP 008 204-161	20-210-01005	2VP 354 034-011
3247-01	2SD 002 582-011	605 44 70	8RA 002 023-001	168020	2VD 008 204-171	20-210-01007	9EL 354 078-011
3248-01	2SD 002 582-021	605 45 70	8RA 002 023-011	168090	2VP 008 204-061	20-210-01009	9EL 171 976-011
3265 01	9EL 950 315-001	605 46 70	8RA 002 023-021	168100	2VD 008 204-061	20-210-01011	9EL 354 074-011
3265 01	9EL 950 315-061	673 50 50	1G4 004 480-001	168270	2VD 008 204-071	20-210-01013	9EL 171 977-011
3266 01	9EL 950 315-031	673 60 50	1G4 004 480-011	168340	2VP 008 204-201	20-210-01014	9EL 171 558-011
3268-01	2XS 955 232-001	758 50 70	2BA 002 652-121	168350	2VP 008 204-211	20-210-01015	9EL 354 071-011
328 01 70	2BM 003 647-021	758 55 70	2BA 002 652-111	168360	2VD 008 204-151	20-210-01016	2VP 354 037-011
331 45 71	2SD 001 680-281	758 60 70	2BA 002 652-101	169021	2VD 008 204-141	20-210-01017	2SD 354 040-021
332 02 25	9EL 116 771-031	759 01 70	2KA 003 389-061	169031	2VD 008 204-231	20-210-01019	9EL 354 076-021
332 03 71	2BA 002 939-171	759 05 70	2KA 003 389-061	169160	2VP 008 204-221	20-210-01020	2VP 354 070-021
336 01 25	9EL 115 830-001	762 44 50	2XW 002 897-051	169170	2VP 008 204-251	20-210-01021	2VP 354 043-021
336 01 70	2BM 002 847-021	906 20 81	8HG 002 240-001	20660617	2SD 002 582-011	20-210-01022	2VP 354 042-021
336 11 70	2BM 002 847-011	906 25 81	8HG 002 240-011	500370	2SD 001 685-211	20-210-01023	9EL 354 066-021
3413-01	8RA 004 412-021	906 30 81	8HG 002 240-011	500370	2SD 001 685-231	20-210-01024	9EL 354 065-021
3453-02	2BM 003 647-021	906 40 81	8HG 002 240-031	620046	8RA 002 014-051	20-210-01026	9EL 354 067-021
3464-01	8RA 002 020-001	Valeo	Hella	620056	8RA 002 014-031	20-210-01027	9EL 354 050-021
351 55 71	2SE 001 680-291	169160	2VD 008 204-251	620066	8RA 002 014-041	20-210-01028	2SK 354 032-021
352 00 51	2SD 001 686-101	169170	2VP 008 204-241	620086	2VP 003 567-121	20-210-01029	9EL 171 558-061
352 10 51	2NE 001 423-011	32005	8GH 002 090-133	672230	2VD 003 567-377	20-210-01030	2VP 354 030-041
352 40 51	2SD 001 685-231	32011	8GH 008 357-001	680121	2SE 001 699-071	20-210-01031	9EL 354 070-021
352 55 51	2ZR 001 423-001	32013	8GH 005 635-				

Manufacturer's no. / Hella no.

Cross-Reference



Visteon	Hella	Volkswagen	Hella	Volkswagen	Hella	Volkswagen	Hella
20-211-01005	2VP 354 034-021	1H6 941 018 AK	1LJ 007 235-261	358 941 018	1LH 005 454-321	600 945 241 B	9EL 122 772-001
20-211-01007	9EL 354 078-021	1H6 945 111	9EL 139 137-061	3A0 941 017 B	1LH 006 840-271	600 945 341	2AA 003 389-041
20-211-01009	9EL 171 976-021	1H6 945 111 A	9EL 139 137-051	3A0 941 018 B	1LH 006 840-281	612 170 620 1	2PF 001 200-011
20-211-01011	9EL 354 074-021	1H6 945 111 B	9EL 139 137-081	3A0 941 067	9HB 006 948-031	612 170 620 1	2AA 001 200-012
20-211-01013	9EL 171 977-021	1H6 945 111 C	9EL 139 137-071	3A0 941 068	9HB 006 948-041	690 945 105	8RA 002 014-051
20-211-01014	9EL 171 558-021	1H6 945 112	9EL 139 138-051	3A0 941 777	8XU 006 946-031	690 945 105	8RA 002 014-052
20-211-01015	9EL 354 071-021	1H6 945 112 A	9EL 139 138-061	3A0 941 778	8XU 006 946-041	690 945 105	1NO 270 204-051
20-211-01016	2VP 354 037-021	1H6 945 112 B	9EL 139 138-071	3A0 941 779	8XU 006 945-031	690 945 105	1NO 270 204-051
20-211-01017	2SD 354 040-011	1H6 945 112 C	9EL 139 138-081	3A0 941 780	8XU 006 945-041	690 941 699 B	1NO 271 247-051
20-211-01019	9EL 354 076-011	1H9 945 111	9EL 142 825-021	3A0 949 117	9EL 147 073-001	690 941 700	1NO 270 204-061
20-211-01020	2VP 354 030-011	1H9 945 111 A	9EL 142 825-031	3A0 953 155 A	9EL 142 459-011	690 941 700 A	1NO 270 204-061
20-211-01021	2VP 354 043-011	1H9 945 112	9EL 142 826-021	3A0 953 156 A	9EL 142 460-011	690 941 700 B	1NO 271 247-061
20-211-01022	2VP 354 042-011	1H9 945 112 A	9EL 142 826-031	3A0 998 139	1NA 006 790-811	690 941 699	1NA 962 530-011
20-211-01023	9EL 354 066-011	1J0 941 295 B	6NM 007 878-041	3A5 945 112	9EL 141 890-031	690 941 699 A	1NA 962 490-011
20-211-01024	9EL 354 065-011	1J0 941 295 C	6NM 007 878-041	3B0 941 015 AL	1LL 008 350-031	690 941 699 E	1NA 963 981-031
20-211-01026	9EL 354 067-011	1J0 955 964 F	9GS 146 999-727	3B0 941 015 AP	1LL 008 350-031	690 941 700	1NA 962 530-021
20-211-01027	9EL 354 050-011	1J5 945 111 M	9EL 963 669-081	3B0 941 016 AL	1LL 008 350-041	690 941 700 A	1NA 962 490-021
20-211-01028	2SK 354 032-011	1J5 945 112 M	9EL 963 670-081	3B0 941 016 AP	1LL 008 350-041	690 941 700 E	1NA 963 981-041
20-211-01029	9EL 171 558-051	1J6 945 095 Q	9EL 151 875-021	3B0 941 017 AH	1LL 008 350-031	690 945 111 A	9EL 962 541-041
20-211-01030	2VP 354 030-031	1J6 945 096 R	9EL 151 876-021	3B0 941 017 AL	1LL 008 350-031	690 945 112 A	9EL 962 542-051
20-211-01031	9EL 354 070-011	1J6 945 111 Q	9EL 151 875-021	3B0 941 017 L	1LF 007 620-071	690 953 041 N	9EL 964 005-021
20-211-01032	9EL 354 054-011	1J6 945 112 Q	9EL 151 876-021	3B0 941 018 AH	1LL 008 350-041	690 953 042 N	9EL 964 006-021
20-211-01033	9EL 354 055-011	1K0 941 699 A	1NO 270 595-011	3B0 941 018 AL	1LL 008 350-041	690 953 049	9EL 962 839-031
20-211-01034	9EL 171 968-011	1K0 941 699 C	1NO 271 284-031	3B0 941 018 L	1LF 007 620-081	690 953 050	9EL 962 839-021
20-211-01035	9EL 171 558-031	1K0 941 700 A	1NO 270 595-021	3B0 941 018 N	1LF 007 520-081	690 953 050 A	9EL 962 840-031
20-211-01036	2VP 354 038-011	1K0 941 700 C	1NO 271 284-041	3B0 941 295	6NM 007 282-631	690 953 050 A	9EL 962 840-021
20-211-01037	2VP 354 039-011	1K6 941 005 AA	1LG 247 007-231	3B0 941 295	9EL 151 829-011	690 941 699 E	1NA 963 981-031
20-211-01039	9EL 171 974-011	1K6 941 005 E	1LG 247 007-031	3B0 953 049 C	9EL 151 830-011	690 941 699 E	1LF 963 709-081
20-211-01040	9EL 171 975-011	1K6 941 005 Q	1LG 247 007-191	3B0 953 050 C	9EL 151 830-011	690 941 699 E	1LF 963 709-081
20-211-01041	9EL 354 079-011	1K6 941 006 AA	1LG 247 007-241	3B7 941 699	1NL 009 034-011	690 941 699 E	1NO 270 255-051
20-211-01042	9EL 354 077-011	1K6 941 006 E	1LG 247 007-041	3B7 941 699 A	1NL 009 034-011	690 941 699 E	1NO 270 255-061
20-211-01043	2NR 010 229-011	1K6 945 095 AA	1LG 247 007-201	3B7 941 700	1NL 009 034-021	690 941 699 E	1LE 247 019-191
20-211-01044	2SD 010 230-011	1K6 945 095 AA	2SD 354 040-011	3B7 941 700 A	1NL 009 034-021	690 941 699 E	1LE 247 019-201
20-211-01045	2SK 354 035-011	1K6 945 095 N	2SD 354 040-011	3C0 941 006 K	1LL 247 014-031	690 941 699 E	1LE 247 019-031
20-211-01046	9EL 354 080-011	1K6 945 095 P	2SD 354 040-021	3C0 941 006 K	1LL 247 014-041	690 941 699 E	1LE 247 019-041
20-211-01049	9EL 354 073-011	1K6 945 096 AA	2SD 354 040-021	3C0 941 699 B	1NO 271 296-031	701 925 071	8JB 004 777-001
20-211-01051	9EL 176 577-011	1K6 945 096 N	2SD 354 040-021	3C0 941 700 B	1NO 271 296-041	701 925 071	8JB 004 777-002
20-211-01052	9EL 176 576-011	1K6 945 096 P	2SD 354 040-021	3C0 953 041	2BA 010 118-011	701 941 699 J	1NB 008 122-011
20-211-01053	9EL 176 574-011	1T0 941 699	1NO 270 596-051	3C0 953 041 C	2BA 010 118-011	701 941 700 J	1NB 008 122-021
20-211-01054	9EL 176 575-011	1T0 941 699 C	1NO 271 289-031	3C0 953 041 F	2BA 010 118-031	701 945 095 01C	9EL 146 371-001
20-211-01056	9EL 354 081-011	1T0 941 699 D	1NO 271 295-031	3C0 953 041 H	2BA 010 118-031	701 945 096 01C	9EL 146 371-001
20-230-01001	2ZR 354 063-011	1T0 941 700	1NO 270 596-061	3C0 953 042	2BA 010 118-021	701 945 112	9EL 146 372-001
20-230-01002	2ZR 354 052-011	1T0 941 700 C	1NO 271 289-041	3C0 953 042 C	2BA 010 118-021	701 945 112	9EL 146 372-001
20-230-01003	2ZR 354 069-011	1T0 941 700 D	1NO 271 295-041	3C0 953 042 E	2BA 010 118-041	701 945 729	9EL 146 373-001
20-240-01003	2NE 354 053-011	1T0 945 095 C	2VP 008 759-051	3C0 953 042 F	2BA 010 118-021	701 947 125	9EL 856 010-001
20-240-01004	2NE 354 068-021	1T0 945 095 J	2SK 009 477-051	3C0 953 042 H	2BA 010 118-021	701 953 049	9EL 136 401-011
20-241-01001	2NE 354 062-021	1T0 945 095 N	2SK 009 477-051	411 941 047	9AG 084 320-005	701 953 050	9EL 136 402-011
20-241-01002	2NE 354 051-021	1T0 945 096 C	2VP 008 759-061	411 941 699	9FF 085 642-001	702 941 017	1LJ 006 051-191
20-241-01003	2NE 354 053-021	1T0 945 096 J	2SK 009 477-061	431 941 159 B	9HD 121 297-001	702 941 018	1LJ 006 051-201
20-252-01002	2XX 354 033-021	1T0 945 096 N	2SK 009 477-061	438 941 663	1LB 003 177-511	702 941 018	6ZE 001 759-071
20-253-01002	2XX 354 033-011	200 953 157	9EL 088 538-001	443 945 217	9EL 126 339-021	702 941 018	6ZE 001 759-051
308 8401 7	2RL 008 064-101	211 945 245 AD	9EL 113 065-001	443 945 218	9EL 126 340-021	702 941 018	1NO 270 481-061
Volkswagen	Hella	211 951 217 B	3AF 003 399-041	445 945 217	9EL 129 149-021	702 941 018	2SK 008 579-091
110 542 001	2PF 003 014-071	211 951 217 B	3AF 003 399-051	445 945 218	9EL 129 150-021	702 941 018	2SK 008 579-111
111 941 605 A	9GH 116 966-011	211 951 217 C	3AF 003 399-051	445 945 218	2AA 001 200-141	702 941 018	2SK 008 579-101
111 945 701	2NE 002 985-001	211 953 061 B	9SG 703 965-007	445 945 217	6ED 004 778-001	702 941 018	2SK 008 579-121
111 947 111 E	2JA 002 532-011	251 945 111 D	2BA 001 127-201	445 945 218	9ES 145 599-001	702 941 018	2SK 008 579-131
112 941 039 M	1L8 003 060-561	251 945 111 H	9EL 122 149-011	445 945 218	9ES 137 170-015	702 941 018	2RL 008 065-001
114 941 753 H	1L8 003 060-691	251 945 112 H	9EL 122 150-011	445 945 218	9ES 145 600-001	702 941 018	2RL 008 065-101
147 943 021	2KA 001 389-101	251 945 112 H	9EL 122 150-011	445 945 218	6NM 007 282-211	702 941 018	2RL 008 065-107
161 949 101	2BM 003 647-021	271 941 091 G	9EL 852 820-001	445 945 217	1NL 006 150-071	702 941 018	9EL 862 171-001
161 953 081	9EL 123 323-011	281 941 091	9EL 855 097-001	445 945 218	1NL 006 150-081	702 941 018	9EL 862 172-001
161 953 082	9EL 123 324-011	281 945 105	8RA 002 014-031	445 945 218	9EL 145 997-021	702 941 018	9GD 862 734-001
171 943 021 B	2KA 002 445-111	281 945 105	8RA 002 014-032	445 945 217	9EL 145 998-021	702 941 018	1NO 271 247-051
171 953 055	2BA 002 939-171	281 945 729	9EL 146 373-001	445 945 217	2BM 003 647-021	702 941 018	1NO 271 247-061
171 953 055 D	2BA 002 939-171	281 947 103	2JA 003 354-001	445 945 218	9EL 139 383-031	702 941 018	2SK 008 579-111
171 953 141	9EL 116 771-031	281 953 357	9EL 116 907-001	445 945 218	9EL 145 833-021	702 941 018	2SK 008 579-111
181 941 425	9GH 096 532-001	283 943 111	9BG 101 230-001	445 945 218	9EL 139 384-031	702 941 018	2SK 008 579-111
181 945 701 A	2NE 003 030-151	283 943 111 A	9BG 121 587-031	445 945 218	9EL 145 834-021	702 941 018	2SK 008 579-091
181 947 303	2AB 001 208-001	283 943 111 A	9BG 121 587-037	445 945 217	9EL 138 567-031	702 941 018	2SK 008 579-091
183 941 101	9XR 854 840-001	283 945 069	2PF 001 648-161	445 945 217 B	9EL 138 567-061	702 941 018	2SK 008 579-091
183 945 095 A	2SD 002 582-011	283 945 095 C	2VP 003 567-111	445 945 218	9EL 138 568-031	702 941 018	2SK 008 579-101
183 945 095 A	2SD 002 582-017	283 945 096 C	2VP 003 567-121	445 945 218 B	9EL 138 568-061	702 941 018	2SK 008 579-101
183 945 096	2SD 002 582-021	283 945 096 C	2VP 003 567-127	4A9 945 217	9EL 140 063-021	702 941 018	2SK 008 579-101
183 945 096	2SD 002 582-027	283 945 341	2SA 001 259-751	4A9 945 218	9EL 140 064-021	702 941 018	2SK 008 579-121
183 945 227 A	9EL 112 743-001	283 945 341	2SA 001 259-757	4B0 941 029 L	1LL 007 821-291	702 941 018	2SK 008 579-121
183 945 228	9EL 112 741-001	283 945 341 A	2PF 003 389-041	4B0 941 030 L	1LL 007 821-301	702 941 018	2SK 008 579-111
191 941 699 D							



Manufacturer's no. / Hella no.

Cross-Reference

Volkswagen	Hella	Volkswagen	Hella	Volkswagen	Hella	Volvo	Hella
823 941 653	1K3 114 155-001	KDWHLO9157	2PS 962 964-037	KSP 953 353 A	2BA 964 169-507	1 438 796 7	2VA 343 640-207
823 947 105 B	2JA 002 931-031	KDWHLO9161	9EL 855 097-001	N0177173	8GP 002 067-241	1 443 210 0	8JB 004 777-001
867 941 701 B	1NL 006 280-061	KDWHLO9172	1GA 996 142-041	N0177175	8GP 002 067-241	1 443 210 0	8JB 004 777-002
867 941 702	1NL 006 280-061	KDWHLO9200	8HG 116 741-801	N 017 738 2	8GD 002 078-121	1 452 913 7	8HG 006 294-031
867 943 021	2KA 002 445-171	KDWHLO9201	2XS 950 071-031	N 102 564 01	8GA 006 841-121	1 452 126 1	3AF 003 399-061
893 941 091	9EL 852 061-001	KDWHLO9202	2XS 003 168-131	N 10320101	8GH 007 157-121	1 453 255 1	3AF 003 399-071
893 945 217	9EL 131 651-031	KDWHLO9204	1G8 002 340-011	N10 445 701	8GS 007 949-101	1 455 469 4	8HG 990 368-001
893 945 218	9EL 131 652-031	KDWHLO9205	8XT 002 120-001	N 105 296 01	8GH 008 357-001	1 455 469 4	8HG 990 368-007
893 945 225 A	9EL 131 613-031	KDWHLO9206	2JA 004 192-001	N 185 002	8RA 002 015-021	1 500 714	9EL 110 013-001
893 945 225 B	9EM 131 613-021	KDWHLO9209	2BA 001 227-201	N47 82 00 525	2ZR 001 193-011	1500714 VSE	9EL 110 013-001
893 945 226 A	9EL 131 614-031	KDWHLO9210	8GM 002 091-121	N77 82 00 518	2BM 001 313-001	1 500 715	9EL 110 014-001
893 945 226 B	9EM 131 614-021	KDWHLO9214	8GH 002 857-121	N77 82 00 518	2BM 001 313-002	1500715 VSE	9EL 110 014-001
893 953 049	9EL 135 007-001	KDWHLO9216	2BA 003 236-021	N 903 605 01	8GP 938 026-001	1 500 754	9EL 092 435-011
893 953 050	9EL 135 008-001	KDWHLO9216	2BA 003 236-027	Z 010 549 TE	2AB 004 532-021	1 500 755	9GD 102 484-001
895 941 699	1NL 005 150-051	KDWHLO9217	8JA 001 915-001	Z052010	9EL 007 720-851	1 501 357	2JA 001 360-001
895 941 700	1NL 005 150-061	KDWHLO9223	2AA 001 200-131	Z052551007	2PS 008 138-821	1 507 094	2BA 002 324-011
8A0 945 217	9EL 140 347-021	KDWHLO9224	2AA 001 200-151	Z052551018	2PS 008 138-801	1 507 095	2BA 002 324-021
8A0 945 217 B	9EL 140 347-021	KDWHLO9225	2AA 003 257-041	Z052551041	2PS 008 138-811	1 507 127 2	2PF 008 405-051
8A0 945 217 C	9EL 140 347-021	KDWHLO9225	2AA 003 257-042	Z052799	1NL 008 383-821	1 507 127 2	2PF 008 405-057
8A0 945 218	9EL 140 348-021	KDWHLO9230	2AA 001 204-001	Z052802 007	9EL 008 980-801	1 507 127 7	2BA 008 221-001
8A0 945 218 B	9EL 140 348-021	KDWHLO9233	8JA 001 921-102	Z052802 041	9EL 008 980-811	1 507 127 7	2BA 008 221-007
8A0 945 218 C	9EL 140 348-021	KDWHLO9236	8GM 002 092-121	Z 401 559 WE	8PA 007 732-013	1 507 128 0	9XB 161 749-007
8A0 953 049 A	9EL 141 605-011	KDWHLO9246	6ED 004 778-001	Z 401 560 WE	8PA 007 732-003	1 507 128 9	1K0 008 191-001
8A0 953 050 A	9EL 141 606-011	KDWHLO9252	2BA 001 275-011			1 507 128 9	1K0 008 191-007
8D0 953 049	9EL 158 254-011	KDWHLO9253	8GM 002 094-121			1 509 316	2SE 001 688-151
8D0 953 049 A	9EL 158 254-011	KDWHLO9262	2SE 002 844-011			1 509 319	2SD 001 688-161
8D0 953 050	9EL 158 254-021	KDWHLO9263	9GD 856 863-001			1 512 294 2	2SE 001 688-161
8D0 953 050 A	9EL 158 254-021	KDWHLO9263	9XR 855 975-001			1 512 294 2	1K0 247 043-021
8E0 941 699 B	1NO 009 594-011	KDWHLO9310	8GH 002 089-133			1 512 294 2	1K0 247 043-027
8E0 941 699 C	1NO 010 380-011	KDWHLO9320	9EL 856 010-001			1 517 025	9EL 110 918-001
8E0 941 700 B	1NO 009 594-021	KDWHLO9327	2JA 004 531-001			1 520 119 7	2ZR 996 012-111
8E0 941 700 C	1NO 010 380-021	KDWHLO9329	2AB 004 532-021			1 565 598	8JA 001 915-001
8E5 945 093	2SA 965 038-031	KDWHLO9412	2XM 004 444-001			1 566 887	2ZR 001 423-001
8E5 945 093 A	2SA 965 038-031	KDWHLO9426	2SA 003 014-051			1 566 888	9ES 106 588-001
8E5 945 094	2SA 965 038-041	KDWHLO9427	2BA 003 014-011			1 576 963	2NE 001 423-011
8E5 945 094 A	2SA 965 038-041	KDWHLO9430	1G4 003 470-031			1 577 794	2KA 001 366-281
8E5 945 217	9EL 153 923-021	KDWHLO9447	1TA 003 570-101			1 578 652	9KH 096 532-001
8E5 945 218	9EL 153 924-021	KDWHLO9458	2XS 005 020-001			1 587 794	2KA 001 386-281
8L0 941 003 AH	1LL 008 306-151	KDWHLO9458	2XS 005 020-002			1 594 161	1LG 004 679-051
8L0 941 004 AH	1LL 008 306-161	KDWHLO9458	8HG 006 294-031			1 620 476	2SL 005 883-031
8L0 953 049	9EL 963 112-011	KDWHLO9460	2XW 002 897-051			1 620 477	2SK 005 883-021
8L0 953 050	1LJ 009 648-031	KDWHLO9461	8JA 004 412-041			1 620 478	2SL 005 883-041
8P0 941 003 AK	1LJ 009 648-031	KDWHLO9475	8GP 002 095-241			1 620 480	9EL 135 548-001
8P0 941 003 BC	1LJ 009 648-041	KDWHLO9487	2RL 007 337-121			1 629 837	8GA 002 083-251
8P0 941 004 AK	1LJ 009 648-041	KDWHLO9488	1G3 005 760-041			1 682 025	8GP 002 067-261
8P0 941 004 BC	1NO 247 003-011	KDWHLO9489	8MK 004 806-001			182 032	8GD 002 084-251
8P0 941 700 A	1NO 247 003-021	KDWHLO9493	2AB 004 532-011			20002203560	2KA 001 386-281
A 37 - 2903	2SB 003 018-031	KDWHLO9496	8GJ 002 525-941			20002174120	2RL 008 060-111
A 37 - 3119	9EL 115 003-035	KDWHLO9500	8GA 002 071-251			20002174760	1S5 003 178-431
A 37 - 3140	1GA 007 506-011	KDWHLO9503	9XD 857 445-801			20002193480	9EL 118 633-001
A 37 - 3140	1GA 007 506-012	KDWHLO9507	2NE 006 609-001			20002230900	9EL 115 003-011
A 37 - 3223	2BA 003 014-011	KDWHLO9507	2NE 006 609-007			20002804478	2JA 006 447-251
ASE 401 559 00	8PA 007 732-013	KDWHLO9508	2NE 006 609-017			20002804478	2VP 006 040-111
ASE 401 560 00	8PA 007 732-003	KDWHLO9508	2NE 006 609-017			20002804478	2VP 006 040-117
ASE 401 563 00	9XS 861 736-001	KDWHLO9510	2RL 007 337-101			20002804479	2VP 006 040-121
KDW 9H 10666	2AA 001 204-011	KDWHLO9511	2XW 007 146-001			20002804780	2VP 006 040-127
KDWHLO9129	2AA 001 200-041	KDWHLO9514	9MK 860 255-001			20002813699	4RA 003 530-051
KDWHLO9230	2AA 001 204-001	KDWHLO9517	9GD 859 037-001			20002903490	9EL 137 307-001
KDWHLO9493	2AB 004 532-011	KDWHLO9521	2SD 001 688-171			20002903491	9EL 137 308-001
KDWHLO9527	1G4 003 470-141	KDWHLO9522	2SD 001 688-141			20002903856	9EL 136 825-001
KDWHLO9527	1G4 003 470-147	KDWHLO9524	8GA 002 071-131			20002903858	9EL 136 825-011
KDWHLO9209	2BA 001 277-011	KDWHLO9526	2AA 003 257-031			20002907237	9EL 990 186-001
KDWHLO9007	9EL 854 912-001	KDWHLO9527	1G4 003 470-141			20003402650	8GJ 002 525-251
KDWHLO9012	8GP 002 068-121	KDWHLO9527	1G4 003 470-147			20004373253	6ZE 001 759-071
KDWHLO9027	8HG 002 365-001	KDWHLO9529	2JA 004 531-011			20004374284	2SD 002 776-231
KDWHLO9028	2BA 001 277-021	KDWHLO9534	9MM 859 358-801			20004374274	2SD 002 776-237
KDWHLO9029	2BA 001 277-011	KDWHLO9535	9DX 859 626-001			020004374275	2SD 002 776-241
KDWHLO9031	9EL 852 061-001	KDWHLO9536	2RL 007 337-021			020004374275	2SD 002 776-247
KDWHLO9033	2BA 003 022-021	KDWHLO9537	9EL 852 820-001			20004374278	2BA 001 277-021
KDWHLO9044	8GP 002 068-241	KDWHLO9540	2VP 006 040-111			20004374281	2SA 001 259-751
KDWHLO9045	6ZE 001 759-071	KDWHLO9540	2VP 006 040-121			20004374281	2SA 001 259-757
KDWHLO9046	6ZE 001 759-051	KDWHLO9541	2VP 006 040-121			20004374284	8GH 002 089-131
KDWHLO9050	6ED 004 778-011	KDWHLO9541	2VP 006 040-127			020004374290	2ZR 996 012-111
KDWHLO9053	2RL 007 900-001	KDWHLO9552	2RL 006 846-101			20004374292	2DA 996 012-041
KDWHLO9054	9XD 861 995-801	KDWHLO9555	2AA 003 257-001			20004374312	2X5 005 020-001
KDWHLO9057	2RL 007 900-201	KDWHLO9557	9GD 856 466-001			20004374312	2X5 005 020-002
KDWHLO9061	3AG 003 399-081	KDWHLO9590	8GA 002 073-241			20004374312	2X5 005 020-003
KDWHLO9064	2AB 001 208-001	KDWHLO9591	8GH 002 089-251			20004374369	8HG 006 294-021
KDWHLO9066	2AA 001 204-011	KDWHLO9591	8GH 002 089-253			20005174002	8RA 002 014-051
KDWHLO9068	2JA 001 364-001	KDWHLO9611	8GH 002 073-132			20005174002	8RA 002 014-052
KDWHLO9071	1G5 003 241-021	KDWHLO9639	2VA 006 040-291			20005174007	8JA 001 909-011
KDWHLO9073	2JA 003 231-001	KDWHLO9639	2VA 006 040-297			20005230616	8GP 002 095-241
KDWHLO9074	2AB 004 532-001	KDWHLO9640	2VP 006 040-301			20005230620	8GH 002 089-251
KDWHLO9078	8GA 002 074-121	KDWHLO9640	2VP 006 040-307			20005230620	8GH 002 089-253
KDWHLO9083	8GM 002 091-131	KDWHLO9651	3AF 003 399-041			20005239651	1G4 003 470-051
KDWHLO9086	2BA 003 022-001	KDWHLO9652	3AF 003 399-051			20007050633	8GP 002 067-241
KDWHLO9087	2JA 003 354-001	KDWHLO9654	2RL 007 337-011			2 023 560	8GA 002 071-251
KDWHLO9098	9AR 120 266-001	KDWHLO9659	2JA 001 357-002			20 379 338	2KA 001 386-281
KDWHLO9099	8GA 002 083-131	KDWHLO9667	8JA 001 925-001			20 453 682	9XB 136 202-005
KDWHLO9100	8JA 003 526-001	KDWHLO9668	2RL 007 900-551			20 453 766	1FB 007 892-011
KDWHLO9102	2AA 001 201-011	KDWHLO9674	2BA 002 324-011			2 048 861 4	1NB 007 892-001
KDWHLO9111	8RL 002 009-011	KDWHLO9675	2BA 002 324-021			2 050 343 5	2AB 004 532-031
KDWHLO9115	2RL 008 061-001	KDWHLO9677	2JA 005 590-157			2 050 343 6	2BM 002 847-011
KDWHLO9116	8HG 854 516-001	KDWHLO9681	2JA 001 331-011			2 050 485 8	2BM 002 847-021
KDWHLO9129	2AA 001 200-041	KDWHLO9683	2RL 008 364-021			2 052 079	1NA 008 284-001
KDWHLO9131	8JB 004 777-001	KDWHLO9690	9MM 862 358-801			2 052 079 4	8JB 001 943-001
KDWHLO9132	8JB 004 777-002	KSP 941 675	9GH 152 654-007			2 052 551 0	8JB 001 943-001
KDWHLO9132	1GA 007 506-012	KSP 941 781 A	1K0 008 191-001			2 054 372 5	8WT 008 549-701
KDWHLO9133	8KB 990 299-001	KSP 945 225	1K0 008 191-007			2 054 372 5	8JD 156 151-807
KDWHLO9134	8GH 002 090-133	KSP 945 226	2SD 964 169-411			2 055 172 0	8JD 156 151-807
KDWHLO9136	2SD 001 679-001	KSP 945 227 A	2SD 964 169-401			2 055 172 0	2BA 008 221-041
KDWHLO9139	2DA 003 014-031	KSP 945 227 A	2SB 964 169-531			2 055 689 0	2BA 008 221-047
KDWHLO9151	2DA 003 014-037	KSP 947 101	2SB 964 169-531			2 055 689 0	2DA 959 071-237
KDWHLO9156	2XW 003 146-001	KSP 953 351	2PF 003 563-151			2 055 716 7	2SA 008 805-001
KDWHLO9157	9GD 862 08						

Manufacturer's no. / Hella no.

Cross-Reference



Volvo	Hella	Volvo	Hella	Volvo	Hella	Volvo	Hella
2 055 717 2	2NE 008 221-031	337 377	2SE 001 686-142	5 403 000 1	2SA 005 200-331	7 036 512 1	2ZR 005 603-061
2 055 717 2	2NE 008 221-037	337 378	2SD 001 686-101	544 218	2SB 001 259-261	7 036 512 2	2ZR 005 603-067
2 055 717 5	2DA 008 805-011	3 402 018	2KA 005 049-008	547 337	8RA 002 014-051	7 036 512 3	2DA 003 734-011
2 055 717 5	2DA 008 805-017	3 402 626	2JA 003 354-001	547 337	8RA 002 014-052	70 504 326	8GH 002 090-133
2 055 717 7	2BA 008 805-051	34 026 282	8GA 002 071-131	558 925	8GM 002 092-241	7 050 630 2	8GD 002 084-251
2 055 717 7	2BA 008 805-057	3 402 650	8GJ 002 525-251	6 211 443	9EL 113 324-001	7 050 631	8GP 002 067-241
2 057 384 9	9GT 137 236-007	3 430 003	8GD 004 772-121	6 212 166	9EL 854 912-001	7 050 635	8GP 002 066-241
2 072 821 0	2XW 003 146-001	345 133	8GA 006 841-121	6 229 297	2BE 001 278-021	7 050 637	8GH 002 090-251
2 073 216 8	8JA 003 526-001	348 750	2SE 001 685-221	6 229 299	2BE 001 278-011	7 050 637	8GH 002 090-253
2 073 358 6	2PG 963 639-401	348 750	2SE 001 685-227	6 233 508	2JA 001 360-001	7 050 638	8GA 002 071-251
2 073 752 4	2JA 003 231-001	355 700	2ZR 001 423-001	6 234 659	9EL 087 769-001	7 050 637	8GA 002 073-241
2 076 848 9	2XS 005 020-011	356 720	2KA 001 389-101	6 235 604	2BA 002 652-101	7 057 450 2	8GD 002 084-131
2 076 848 9	2XS 005 020-017	362 540	2BA 001 221-031	6 235 604	2BA 002 652-107	7 057 470 7	8GM 002 092-121
2 084 700 2	8JB 004 777-001	362 541	2BA 001 221-041	6 612 583	2KA 001 389-101	7 349 573	9EL 126 294-001
2 084 700 2	8JB 004 777-002	363 716	2SE 001 685-201	6 622 109	2JA 001 346-011	7 352 959	2PF 001 648-161
2 087 712 9	9GD 159 740-007	3 930 861	2AA 001 200-001	6 627 514	8RA 002 020-001	7 353 869	2BE 001 259-061
2 088 426 7	1NO 008 582-011	3 930 862	2AA 001 200-131	6 627 514	8RA 002 020-002	7 356 266	9EL 052 476-001
2 088 426 7	1NO 008 582-017	3 930 863	2AA 001 200-001	6 627 514	8RA 002 020-003	784 423	2BA 001 227-211
2 089 175 2	2SB 008 405-091	3 930 863	2AA 001 200-011	6 644 374	9EL 112 744-001	784 593	8JA 001 909-001
2 090 489 5	2PF 959 590-401	3 930 863	2AA 001 200-012	6 644 375	9EL 112 743-001	8 001 010 34	2SA 961 167-011
2 090 489 5	2PF 959 590-407	3 950 305	1DL 005 600-097	6 644 376	9EL 112 741-001	8001331900003	9GH 152 654-007
2 091 489 0	2PS 963 639-011	3 950 306	1DL 005 600-107	6 778 311	2SL 005 883-031	8001331900008	2SA 005 603-021
2 091 489 0	2PS 963 639-017	398 1455	2VD 008 205-051	6 778 312	2SK 005 883-021	8001331900008	2SA 005 603-027
2 097 021 0	2JA 003 354-001	398 1456	2VP 008 205-031	6 778 313	2SK 005 883-011	8001331900007	2DA 005 603-031
2 107 111 6	9XB 152 977-001	398 1458	2VD 008 205-041	6 778 314	2SL 005 883-041	8001331900007	2DA 005 603-037
2 116 600 9	2XA 959 790-401	398 1459	2VP 008 205-031	6 778 319	9EL 135 548-001	8003331900003	2BA 005 603-117
2 116 600 9	2XA 959 790-407	3 981 593	1LG 006 898-091	6 817 027	9EL 142 723-011	8003331900005	8KA 152 134-007
2 128 602 7	2JA 343 720-121	4 038 323	2AA 001 200-031	6 817 028	9EL 142 724-011	8 004 000 08	2JA 001 330-031
2 129 903 5	8JD 156 151-807	4 372 937	8RA 002 014-041	7 030 293	9GT 134 655-007	8 140 055	1FE 006 300-251
2 129 903 6	8JA 746 184-022	4 372 937	8RA 002 014-042	7 030 294	9GT 143 133-007	8 144 285	1LG 006 898-051
2 138 622 3	8KA 157 425-007	4 373 253	6ZE 001 759-071	7 030 312	1BL 007 834-047	8 144 693	1FE 006 300-251
2 139 121 7	9GH 158 051-007	4 374 231	2KA 003 389-061	7 030 313	1KL 007 834-067	8 156 751	2XW 002 897-051
2 146 447 3	1K0 247 043-021	4 374 231	2KA 003 389-062	7 030 531 5	2PF 006 679-007	8202331900001	8WS 008 549-501
2 146 447 3	1K0 247 043-027	4 374 231	2KA 003 389-068	7 030 531 6	2SA 006 679-027	8 226 603 6	1NO 008 582-011
2 146 470	2SW 003 014-131	4 374 248	2BA 002 324-011	7 030 531 8	2BE 004 119-021	8 226 603 6	1NO 008 582-017
2 174 120	2RL 008 060-111	4 374 249	2BA 002 324-021	7 030 532 0	1NL 007 186-047	8 229 257 7	6NM 008 299-501
2 174 760	1S5 003 178-431	4 374 261	1GD 003 590-701	7 030 532 2	2BA 003 236-021	85 104 436	2RL 008 060-111
2 183 430 0	8GP 002 095-121	4 374 274	2SD 002 776-231	7 030 532 2	2BA 003 236-027	85 104 437	2RL 008 061-111
2 193 480	9EL 118 633-001	4 374 274	2SD 002 776-237	7 030 532 4	2DA 003 236-031	85 104 765	9EL 862 141-001
2 230 900	9EL 115 003-011	4 374 275	2SD 002 776-241	7 030 532 4	2DA 003 236-037	8 510 479 6	2PF 003 563-151
2 263 770	2JA 001 330-001	4 374 275	2SD 002 776-247	7 030 532 6	2KA 005 049-011	8 510 479 9	2PS 962 964-012
2 263 770	2JA 001 330-007	4 37 4278	2BA 001 277-021	7 030 532 6	2KA 005 049-017	8 510 479 9	2PS 962 964-018
2 281 010	9GH 096 532-001	4 374 280	2PF 001 259-631	7 030 533 0	2BM 006 692-011	8 511 107 1	9EL 860 627-001
2 284 699	9EL 110 918-001	437 428 1	2SA 001 259-751	7 030 533 0	2BM 006 692-017	864 417	8HG 002 240-021
2 289 665	9EL 146 491-001	437 428 1	2SA 001 259-757	7 030 533 1	2BM 006 692-021	9 126 960	9EL 138 601-041
240 413	8RA 002 014-051	4 374 284	8GH 002 089-133	7 030 533 1	2BM 006 692-027	9 126 961	9EL 138 602-041
240 413	8RA 002 014-052	4 374 290	2ZR 996 012-111	7 030 534 5	2PS 963 639-011	9 151 629	9EL 341 325-311
2 800 822	2SD 002 776-231	4 374 292	2DA 996 012-041	7 030 534 5	2PS 963 639-017	9 151 630	9EL 341 325-321
2 800 822	2SD 002 776-237	4 374 312	2XS 005 020-001	7 032 441 3	2NE 003 030-151	9 151 633	9EL 341 326-311
2 800 823	2SD 002 776-241	4 374 312	2XS 005 020-002	7 032 441 5	8RA 003 326-031	9 151 636	9EL 341 326-321
2 800 823	2SD 002 776-247	4 374 312	2XS 005 020-003	7 032 441 7	2DA 959 071-737	9 187 922	9EL 149 957-121
2 801 241	2JA 006 447-251	43 743 170	8RA 002 023-001	7 032 442 1	2BM 008 355-001	9 187 925	9EL 149 958-121
2 801 243	1GA 006 876-001	4 374 366	2SE 002 578-701	7 032 442 1	2BM 008 355-007	9 483 182	9EL 147 723-071
28 012 453	2RL 006 846-001	4 374 366	2SE 002 578-707	7 032 442 3	2BA 008 221-001	9 483 183	9EL 147 724-071
2 804 477	2JA 006 487-261	4 374 369	8HG 006 294-021	7 032 442 3	2BA 008 221-007	9 54 851	8HG 002 240-031
2 804 478	2VP 006 040-111	460 059	2KA 001 389-101	7 032 442 9	1K0 008 191-021	958 902	8GM 002 091-131
2 804 478	2VP 006 040-117	4 726 212	2SB 001 301-021	7 032 442 9	1K0 008 191-027	965 830	8GP 002 067-121
2 804 479	2VP 006 040-121	4 780 959	8RA 002 023-021	7 032 442 9	2BA 003 236-541	966 327	8GA 007 997-071
2 804 479	2VP 006 040-127	4 780 964	2PS 002 727-001	7 032 443 1	2PF 961 167-021	966 327	8GP 002 095-241
2 804 482	1GA 007 506-011	4 780 974	8RA 002 014-051	7 032 443 1	8JB 004 777-001	981 465	8GH 007 157-121
2 804 482	1GA 007 506-012	4 780 974	8RA 002 014-052	7 032 443 1	8JB 004 777-002	VOE1147756	2KA 003 389-061
2 811 040	9GH 993 988-007	4 785 120	2BE 002 582-031	7 032 443 2	2PS 006 717-051	VOE1147756	2KA 003 389-062
2 813 699	4RA 003 530-051	4 785 121	2SD 002 582-011	7 032 443 2	2PS 006 717-057	VOE1147756	2KA 003 389-068
2 813 715	8HG 006 294-011	4 785 121	2SD 002 582-017	7 032 443 2	8RA 002 014-031	VOE11370511	8GH 002 089-251
288 139	2JA 004 531-011	4 785 122	2SD 002 582-021	7 032 443 2	8RA 002 014-032	VOE11370511	8GH 002 089-253
288 262	2TM 006 717-047	4 785 122	2SD 002 582-027	7 032 443 2	1NL 007 834-057	VOE11713095	9EL 860 627-011
290 349 0	9EL 137 307-001	4 785 537	2PF 001 648-161	7 032 443 2	2SB 005 603-137	VOE11998512	9EL 859 020-001
2 903 491 9	9EL 137 308-001	4 803 218	2SD 001 685-231	7 032 442 9	9HD 155 239-001	VOE143 794 69	8RA 003 660-007
2 903 856	9EL 136 825-001	4 803 218	2SD 001 685-232	7 034 770 0	9GH 145 943-001	VOE14385291	2VA 343 640-117
2 903 858	9EL 136 825-011	4 803 622	2BA 002 652-111	7 034 770 1	1K0 008 191-041	VOE14385292	2VP 343 640-081
2 906 779	8GH 007 157-241	4 803 622	2BA 002 652-117	7 034 770 1	1K0 008 191-047	VOE14385292	2VP 343 640-087
2 907 237	9EL 900 186-001	4 803 623	2BA 002 652-121	7 034 592 4	2XS 005 020-001	VOE14387965	2VP 343 640-091
030005050011	8GH 002 089-133	4 803 623	2BA 002 652-127	7 034 592 4	2XS 005 020-002	VOE14387965	2VP 343 640-097
030005050032	8GA 002 073-121	4 831 317	2JA 001 330-001	7 034 592 4	2XS 005 020-003	VOE14387967	2VA 343 640-207
030005050038	8GJ 002 525-131	4 831 317	2JA 001 330-007	7 034 770 0	2NE 005 603-071	VOE3570654	2BA 003 014-011
30005080042	8JA 003 526-001	4 864 417	8HG 002 240-021	7 034 770 0	2NE 005 603-077	VOE4785122	2SD 002 582-021
30005170031	2ZR 002 694-001	4 864 457	8RA 003 326-011	7 034 770 1	2DA 005 603-031	VOE4785122	2SD 002 582-027
30005170050	2VP 006 040-121	4 864 457	8RA 003 326-017	7 034 770 1	2DA 005 603-037		
30005170050	2VP 006 040-127	4 941 836	2KA 003 168-021	7 034 770 2	2BA 005 603-117		
30005170052	8RA 002 014-031	5 050 003 1	8GA 002 071-131	7 034 770 3	2SA 005 603-021		
30005170052	8RA 002 014-032	5 050 003 1	8GH 002 089-133	7 034 770 3	2SA 005 603-027		
30005170061	2SD 003 182-061	5 050 032	8GA 002 073-121	7 034 770 4	2ZR 008 221-051		
3000517							



Manufacturer's no. / Hella no.

Cross-Reference

Volvo Trucks	Hella	Volvo Trucks	Hella	ZKW	Hella
1 455 469 4	8HG 990 368-001	7 032 442 1	2BM 008 355-001	564.01.000.03	1NA 009 026-021
1 455 469 4	8HG 990 368-007	7 032 442 1	2BM 008 355-007	575.01.000.00	1NA 009 031-011
1 459 256 5	2SB 009 001-157	7 032 442 3	2BA 008 221-001	575.01.000.01	1NA 009 031-021
1 459 256 6	2BA 009 001-107	7 032 442 3	2BA 008 221-007	597.01.000.00	1NL 009 034-011
1 459 256 7	2ZR 009 001-117	7 032 442 7	1KO 008 191-021	597.01.000.01	1NL 009 034-021
1 500 714	9EL 110 013-001	7 032 442 7	1KO 008 191-027		
1 500 715	9EL 110 014-001	7 032 443 1	2PF 961 167-021		
1 500 754	9EL 092 435-011	7 032 469 5	8JB 004 777-001		
1 507 127 2	2PF 008 405-051	7 032 469 5	8JB 004 777-002		
1 507 127 2	2PF 008 405-057	7 033 103 5	2SB 005 603-137		
1 507 128 0	9XB 161 749-007	7 034 374 6	9HD 155 239-001		
1 507 128 9	1KO 008 191-001	7 034 374 7	9GH 145 943-001		
1 507 128 9	1KO 008 191-007	7 034 569 0	2AB 004 532-051		
1 509 032 5	2XT 959 510-467	7 034 569 0	2AB 004 532-057		
1 509 294 5	9EL 343 142-001	7 034 592 4	2XS 005 020-001		
1 509 304 1	9EL 343 143-001	7 034 592 4	2XS 005 020-002		
1 509 318	2SD 001 688-171	7 034 592 4	2XS 005 020-003		
1 512 294 2	1KO 247 043-021	7 034 770 3	2SA 005 603-021		
1 512 294 2	1KO 247 043-027	7 034 770 3	2SA 005 603-027		
1 518 711 5	2BM 002 652-051	7 034 771 7	2PS 963 639-011		
1 566 887	2ZR 001 423-001	7 034 771 7	2PS 963 639-017		
1 576 963	2NE 001 423-011	7 034 868 3	8HG 116 741-901		
1 578 652	9GH 096 532-001	7 035 395 9	9GD 341 063-007		
1 587 794	2KA 001 386-281	7 036 637 6	8RA 003 326-011		
1 600 969 3	8RA 004 412-001	7 036 637 6	8RA 003 326-017		
1 699 837	8GA 002 083-251	7 036 862 6	2ZR 002 985-261		
182 032	8GD 002 084-251	7 037 154 7	2DA 959 071-737		
2 036 269 5	6NM 008 299-501	7 037 481 3	2SB 008 805-021		
2 037 933 8	9XB 136 202-005	7 037 481 3	2SB 008 805-027		
2 045 376 6	1NB 007 892-001	7 349 573	9EL 126 294-001		
2 048 738 5	1F8 006 800-191	784 423	2BA 001 227-211		
2 050 485 8	1NA 008 284-001	784 593	8JA 001 909-001		
2 052 079 4	8JB 001 943-001	8001331900022	2ZR 008 805-041		
2 055 172 7	2DA 959 071-237	8001331900022	2ZR 008 805-047		
2 055 716 7	2ZR 008 805-041	8001331900025	9GH 158 051-007		
2 055 716 7	2ZR 008 805-047	8003001900004	8GA 002 074-241		
2 055 717 2	2NE 008 221-031	8 156 751	2XW 002 897-051		
2 055 717 2	2NE 008 221-037	8 207 666 8	1F3 161 825-011		
2 055 717 7	2BA 008 805-051	8216271900001	2ZR 003 030-171		
2 055 717 7	2BA 008 805-057	8 510 443 6	2RL 008 060-111		
2 072 821 0	2XW 003 146-001	8 510 443 7	2RL 008 061-111		
2 076 848 6	2XS 005 020-001	8 510 476 5	9EL 862 141-001		
2 076 848 6	2XS 005 020-002	967711	8GP 002 067-261		
2 076 848 6	2XS 005 020-003	VOE14592565	2SB 009 001-157		
2 076 848 9	2XS 005 020-011	VOE14592566	2BA 009 001-107		
2 076 848 9	2XS 005 020-017	VOE14592567	2ZR 009 001-117		
2 087 712 9	9GD 159 740-007	VOE15071272	2PF 008 405-051		
2 088 426 7	1NO 008 582-011	VOE15071272	2PF 008 405-057		
2 088 426 7	1NO 008 582-017	VOE4785120	2BE 002 582-031		
2 097 021 0	2JA 003 354-001	VOE70324423	2BA 008 221-001		
2 105 935 1	2XT 959 510-427	VOE70324423	2BA 008 221-007		
2 117 194 1	2PF 009 514-011	ZM 2903490	9EL 137 307-001		
2 161 654 4	9GH 158 051-007				
2 801 243	1GA 006 876-001	Wegu	Hella		
2 804 482	1GA 007 506-011	420 013	8RA 002 020-001		
2 804 482	1GA 007 506-012	420 106	8RA 002 016-121		
2 806 466	2VP 006 040-111	420 108	8RA 002 016-111		
2 806 466	2VP 006 040-117	420 116	8RA 002 016-101		
290 349 0	9EL 137 307-001	420 401	8HG 002 240-001		
2 907 377	1GA 007 506-001	420 402	8HG 002 240-011		
2 907 377	1GA 007 506-002	420 403	8HG 002 240-021		
2 907 377	1GA 007 506-007	420 405	8HG 002 240-031		
363 716	2SE 001 685-201	Yale / Nacco	Hella		
4 780 974	8RA 002 014-051	1356335	1GA 006 876-001		
4 780 974	8RA 002 014-052	1356350	1GA 006 991-031		
4 785 120	2BE 002 582-031	Yorka	Hella		
4 785 121	2SD 002 582-011	0 12 900 0048	2BA 004 257-011		
4 785 121	2SD 002 582-017	0 12 901 0047	2BA 004 257-021		
4 785 537	2PF 001 648-161	1 62 133 0065	9EL 131 651-031		
4 803 218	2SD 001 685-231	1 62 134 0064	9EL 131 652-031		
4 803 218	2SD 001 685-232	1 62 135 0063	9EM 131 613-021		
4 864 417	8HG 002 240-021	1 62 136 0062	9EL 131 614-031		
4 864 457	8RA 003 326-011	ZKW	Hella		
4 864 457	8RA 003 326-017	316.52.000.00	2SD 001 686-101		
5 170 031	2ZR 002 694-001	425.01.000.00	2BA 002 939-171		
6 211 443	9EL 113 324-001	425.02.000.00	9EL 141 701-001		
6 212 166	9EL 854 912-001	425.02.000.01	9EL 141 702-001		
6 235 604	2BA 002 652-101	425.03.000.02	9EL 144 425-001		
6 235 604	2BA 002 652-107	425.03.000.03	9EL 144 426-001		
6 612 583	2KA 001 389-101	425.13.000.00	9EL 144 425-011		
662 109	2JA 001 346-011	425.13.000.01	9EL 144 426-011		
6 627 514	8RA 002 020-001	441.03.000.00	2XW 007 146-001		
6 627 514	8RA 002 020-002	456.01.000.00	2SE 002 776-211		
6 627 514	8RA 002 020-003	469.01.000.00	2SL 003 567-311		
6 644 374	9EL 112 744-001	469.01.200.00	9EL 122 772-001		
6 644 375	9EL 112 743-001	469.01.200.01	9EL 122 689-021		
6 644 376	9EL 112 741-001	469.02.000.00	2SK 003 567-321		
6 774 450	8RA 003 326-041	469.02.000.00	2SK 003 567-331		
6 774 450	8RA 003 326-047	470.03.000.00	2BA 003 411-001		
7 030 529 3	9GT 134 655-007	470.12.000.01	2BA 007 840-001		
7 030 529 4	9GT 143 133-007	470.15.000.00	2BA 007 839-001		
7 030 531 3	1KL 007 834-067	484.20.000.00	2BM 006 692-011		
7 030 531 8	2BE 004 119-021	484.21.000.00	2BM 006 692-021		
7 030 532 0	1NL 007 186-047	491.01.200.01	1NB 123 581-001		
7 030 532 08	8RA 002 020-001	491.01.201.01	1NB 123 582-001		
7 030 532 08	8RA 002 020-002	493.03.000.00	2BA 003 975-031		
7 030 532 08	8RA 002 020-003	493.04.000.00	2BA 003 975-041		
7 030 532 6	2KA 005 049-011	498.02.000.00	2SA 001 647-041		
7 030 532 6	2KA 005 049-017	515.81.000.02	1NA 009 029-011		
7 030 532 8	8RA 002 020-001	515.81.000.03	1NA 009 029-021		
7 030 532 8	8RA 002 020-002	515.91.000.02	1NA 009 033-011		
7 030 532 8	8RA 002 020-003	515.91.000.03	1NA 009 033-021		
7 030 534 5	2PS 963 639-001	518.01.000.02	1NB 006 270-051		
7 030 534 5	2PS 963 639-007	518.01.000.03	1NB 006 270-061		
7 030 534 5	2PS 963 639-011	532.01.000.01	1BL 007 834-007		
7 030 534 5	2PS 963 639-017	564.01.000.02	1NA 009 026-011		
7 030 534 5	2PS 963 639-177				
7 032 441 7	2DA 959 071-737				

Type Approval Numbers



E1 0130	8WS 008 549-001	E1 1071	2VP 008 272-221	e1 1169	2XD 008 135-811	E1 1240	2RL 008 061-011
E1 0130	8WS 008 549-501	E1 1071	2VP 008 272-811	e1 1169	2XD 008 135-821	E1 1240	2RL 008 062-001
E1 0130	8WT 008 549-101	E1 1071	2VP 008 272-821	e1 1169	2XD 008 135-831	E1 1240	2RL 008 062-011
E1 0130	8WT 008 549-201	E1 1071	2VP 008 272-861	e1 1169	2XD 861 423-011	E1 1240	2RL 008 063-001
E1 0130	8WT 008 549-601	E1 1071	9EL 153 567-101	e1 1169	2XD 861 423-021	E1 1240	2RL 008 063-011
E1 0130	8WT 008 549-701	E1 1077	1LL 008 306-151	e1 1169	2XD 862 019-011	E1 1240	9EL 862 140-001
E1 016	2BA 007 135-001	E1 1077	1LL 008 306-161	e1 1169	2XD 862 111-011	E1 1240	9EL 862 140-021
E1 016	2BA 007 135-011	E1 1078	1LL 008 306-151	E1 11761	2PF 001 650-001	E1 1241	2RL 008 060-101
E1 016	2BA 007 135-021	E1 1078	1LL 008 306-161	E1 11761	9EL 084 110-001	E1 1241	2RL 008 060-111
E1 016	9EL 146 073-001	E1 1078	1LL 008 306-161	E1 11779	2PF 001 638-011	E1 1241	2RL 008 061-101
E1 017	2BA 006 749-051	E1 10881	1LB 247 012-031	E1 11779	2PF 001 638-067	E1 1241	2RL 008 061-111
E1 017	2BA 006 749-061	E1 10881	1LB 247 012-041	E1 11786	2PF 001 634-101	E1 1241	2RL 008 062-101
E1 017	2BA 006 749-071	E1 1091	2VP 008 048-051	E1 11786	2TJ 001 633-211	E1 1241	2RL 008 062-111
E1 017	2BA 006 749-081	E1 1091	2VP 008 048-061	E1 11786	9EL 132 403-001	E1 1241	2RL 008 063-101
E1 01805	9EL 964 005-021	E1 1098	1LF 009 057-031	E1 11786	9EL 132 404-001	E1 1241	2RL 008 063-111
E1 01805	9EL 964 006-021	E1 1099	1LF 009 057-041	E1 11786	9EL 132 404-001	E1 1241	2RL 008 063-111
E1 019	9EL 142 459-011	E1 11	1NA 006 790-071	E1 11793	2PF 003 014-071	E1 1241	2RL 008 064-001
E1 019	9EL 142 460-011	E1 11	1NA 006 790-081	E1 11793	2PF 003 014-301	E1 1241	2RL 008 064-101
E1 021364	9EL 008 759-811	E1 11	1NA 006 790-811	E1 11793	9EL 110 542-001	E1 1241	9EL 862 141-001
E1 0249	8RA 007 051-031	E1 1100	1LF 009 057-031	E1 11794	2PF 001 648-161	E1 1242	2RL 008 065-001
E1 0249	8RA 007 051-041	E1 1101	1LF 009 057-041	E1 11794	2PF 001 648-171	E1 1242	2RL 008 065-011
E1 100	2BA 962 625-821	E1 111	1LG 007 150-111	E1 11794	9EL 108 435-001	E1 1242	9EL 862 171-001
E1 100	9EL 962 839-021	E1 1110	9EL 153 923-021	E1 1182	1LL 008 052-591	E1 1243	2RL 008 065-101
E1 100	9EL 962 840-021	E1 1110	9EL 153 924-021	E1 1182	1LL 008 052-601	E1 1243	2RL 008 065-107
E1 101	9EL 962 839-031	E1 1120	1F0 008 390-001	E1 1182	1LL 008 053-591	E1 1243	2RL 008 065-111
E1 101	9EL 962 840-031	E1 1120	1F0 008 390-301	E1 1182	1LL 008 053-601	E1 1243	9EL 862 172-001
E1 1012	9EL 151 875-021	E1 1120	1F0 008 390-317	E1 1182	5DV 007 760-651	E1 126	2BA 007 042-031
E1 1012	9EL 151 876-021	E1 1120	1F0 008 390-801	E1 1182	8KB 157 198-801	E1 126	2BA 007 042-041
E1 1014	2VP 008 031-051	E1 1120	1F0 008 390-821	E1 1196	2VP 008 863-801	E1 1266	1N0 246 039-011
E1 1014	2VP 008 031-061	E1 1120	1F0 160 197-001	E1 1196	8RA 008 405-001	E1 1266	1N0 246 039-021
E1 102	2BE 003 184-051	E1 113	9ES 144 433-031	E1 1196	8RA 008 405-007	E1 12809	2KA 003 010-007
E1 102	2BE 003 184-061	E1 1133	1LJ 247 046-051	E1 1197	2SA 008 405-011	E1 12815	2KA 001 389-101
E1 102	9EL 118 703-001	E1 1133	1LJ 247 046-071	E1 1197	2SA 008 405-017	E1 12820	2KA 001 386-231
E1 102	9EL 118 705-001	E1 1134	1LJ 247 046-061	E1 1197	2SA 008 405-021	E1 12820	2KA 001 386-241
E1 1032	2PT 008 362-801	E1 1134	1LJ 247 046-081	E1 1197	2SA 008 405-027	E1 12820	2KA 001 386-281
E1 1048	2SA 008 221-127	E1 114	1LG 007 150-121	E1 1201	2XS 008 479-001	E1 12820	2KA 001 386-291
E1 1048	2VP 008 863-801	E1 114	9ES 144 434-031	E1 1201	2XS 008 479-007	E1 12820	2KA 001 386-301
E1 1048	2XA 008 221-021	E1 1142	2VP 008 468-051	E1 1201	2XS 008 479-011	E1 12820	2KA 001 386-497
E1 1048	2XA 008 221-027	E1 1142	2VP 008 468-061	E1 1201	2XS 008 479-017	E1 1284	1LL 008 420-331
E1 1049	2DA 008 221-167	E1 1152	2VP 008 326-051	E1 1201	2XS 008 479-041	E1 1284	1LL 008 420-341
E1 1049	2VP 008 863-801	E1 1152	2VP 008 326-061	E1 1201	2XS 008 479-047	E1 1284	1LL 158 085-011
E1 1049	2XA 008 221-021	E1 11549	2SB 001 240-311	E1 1201	2XS 008 479-051	E1 1284	1LL 158 086-011
E1 1049	2XA 008 221-021	E1 11549	9EM 128 230-001	E1 1201	2XS 008 479-057	E1 1285	1LL 008 420-331
E1 1049	2XA 008 221-027	E1 11550	2SA 001 240-331	E1 1201	2XS 008 479-061	E1 1285	1LL 008 420-341
E1 105	9EL 147 073-801	E1 11551	2DA 001 240-341	E1 1201	2XS 008 479-071	E1 1285	1LL 158 085-011
E1 1050	2NE 008 221-031	E1 11551	9EM 128 229-001	E1 1201	2XS 008 479-081	E1 1285	1LL 158 086-011
E1 1050	2NE 008 221-037	E1 11553	2TJ 001 633-211	E1 1201	2XS 008 479-087	E1 1289	2RL 008 364-021
E1 1050	2NE 008 221-137	E1 11553	9EL 132 403-001	E1 1201	2XS 008 479-091	E1 1290	2RL 008 366-021
E1 1050	2VP 008 863-801	E1 11553	9EL 132 404-001	E1 1201	2XS 008 479-097	E1 1290	2RL 008 366-031
E1 1051	2BA 008 221-041	E1 11554	2TJ 001 633-211	E1 1201	2XS 008 479-107	E1 12949	2KA 001 610-001
E1 1051	2BA 008 221-047	E1 11554	9EL 132 403-001	E1 1201	2XS 008 479-117	E1 12958	2KA 001 378-001
E1 1051	2BA 008 221-147	E1 11583	2TM 003 057-031	E1 1202	1LL 008 350-031	E1 12958	2KA 001 378-041
E1 1051	2VP 008 863-801	E1 11584	2SA 003 057-021	E1 1202	1LL 008 350-041	E1 12958	2KA 001 378-127
E1 1052	2VP 008 863-801	E1 11584	9EL 117 330-011	E1 1203	1LL 008 350-031	E1 12969	2KA 001 622-001
E1 1052	2ZR 008 221-051	E1 11591	2SA 003 236-041	E1 1203	1LL 008 350-041	E1 12969	9EL 108 651-001
E1 1052	2ZR 008 221-057	E1 11591	2SA 003 236-047	E1 1209	1NA 008 283-001	E1 12988	2KA 002 445-111
E1 1052	2ZR 008 221-157	E1 11591	2SA 003 236-048	E1 1209	1NA 008 283-801	E1 130	2SD 003 184-031
E1 1059	2BM 008 355-001	E1 11591	2SA 003 236-341	E1 1210	1FA 008 283-011	E1 130	2SD 003 184-037
E1 1059	2BM 008 355-007	E1 11591	2SA 003 236-341	E1 1210	1FA 008 283-031	E1 130	2SD 003 184-041
E1 1060	9EL 964 501-011	E1 11592	9EL 120 201-001	E1 1210	1FA 008 283-811	E1 130	2SD 003 184-047
E1 1060	9EL 964 502-011	E1 11596	2PF 003 389-041	E1 1210	1FA 008 283-861	E1 130	2SE 003 184-011
E1 1061	9EL 964 541-021	E1 11596	2SD 003 409-201	E1 1211	1NA 008 284-001	E1 130	2SE 003 184-017
E1 1061	9EL 964 542-021	E1 11596	2SD 003 409-207	E1 1211	1NA 008 284-801	E1 130	2SE 003 184-101
E1 1062	9EL 964 483-011	E1 11596	2SE 003 409-191	E1 1212	1FA 008 284-011	E1 130	8RA 123 251-005
E1 1062	9EL 964 484-011	E1 11596	2SE 003 409-197	E1 1212	1FA 008 284-031	E1 130	9EL 118 697-001
E1 1063	9EL 964 479-011	E1 11596	9EL 121 260-051	E1 1212	1FA 008 284-811	E1 130	9EL 118 700-001
E1 1063	9EL 964 480-011	E1 11596	9EL 121 260-061	E1 1212	1FA 008 284-861	E1 130	9EL 118 701-001
E1 1070	2SK 008 272-801	E1 11599	2TJ 003 168-151	E1 1215	1NA 007 976-111	E1 130	9EL 121 431-001
E1 1070	2SK 008 272-831	E1 116	2SD 002 582-011	E1 1215	1NA 007 976-121	e1 1309	2RL 007 900-121
E1 1070	2VP 008 272-211	E1 116	2SD 002 582-017	E1 122	1FA 007 133-021	e1 1309	2RL 007 900-171
E1 1070	2VP 008 272-221	E1 116	2SD 002 582-021	E1 122	1NA 007 133-001	e1 1309	2RL 007 900-191
E1 1070	2VP 008 272-231	E1 116	2SE 002 582-071	E1 1223	2PS 008 541-801	e1 1309	2RL 007 900-221
E1 1070	2VP 008 272-241	E1 116	9EL 112 741-001	E1 1224	2DA 007 858-037	e1 1309	2RL 007 900-241
E1 1070	2VP 008 272-811	E1 116	9EL 112 743-001	E1 123	1NL 007 906-031	e1 1309	2RL 007 900-291
E1 1070	2VP 008 272-821	E1 116	9EL 116 844-001	E1 123	1NL 007 906-041	e1 1309	2RL 007 900-501
E1 1070	2VP 008 272-861	e1 1169	2XD 007 854-801	E1 1236	2VP 008 406-031	e1 1309	2RL 007 900-511
E1 1070	9EL 153 567-101	e1 1169	2XD 007 854-811	E1 1236	2VP 008 406-041	e1 1309	2RL 007 900-521
E1 1071	2SK 008 272-801	e1 1169	2XD 007 854-821	E1 1240	2RL 008 060-001	e1 1309	2RL 007 900-551
E1 1071	2SK 008 272-831	e1 1169	2XD 007 854-831	E1 1240	2RL 008 060-011	e1 1309	2RL 007 900-561
E1 1071	2VP 008 272-211	e1 1169	2XD 008 135-801	E1 1240	2RL 008 061-001	e1 1309	2RL 007 900-631



Type Approval Numbers

e1 1309	2RL 007 900-681	E1 1396	2PS 008 645-001	E1 1480	2SK 964 596-021	E1 17150	1LH 005 454-321
e1 1309	2RL 863 132-001	E1 1396	2PS 008 645-007	E1 1482	2RL 863 132-001	E1 1716	9EL 149 957-121
E1 1313	1LL 008 369-171	E1 1396	2PS 008 645-011	E1 1490	1LF 008 673-091	E1 1716	9EL 149 958-121
E1 1313	1LL 008 369-181	E1 1396	2PS 008 645-187	E1 1490	1LL 160 695-001	E1 17176	1LJ 006 051-191
E1 1313	1LL 008 369-271	E1 1396	2PS 008 645-497	E1 1491	1LF 008 673-101	E1 17177	1LJ 006 051-201
E1 1313	1LL 008 369-281	E1 1396	2PS 008 645-601	E1 1491	1LL 160 696-001	E1 17184	9ES 137 170-015
E1 1313	1LL 009 260-091	E1 1396	2PS 008 645-607	E1 1492	1LF 008 673-091	E1 1719	2RL 863 106-001
E1 1313	1LL 009 260-101	E1 1396	2PS 008 645-611	E1 1493	1LF 008 673-101	E1 1719	2RL 863 106-011
E1 1313	1LS 008 369-491	E1 1396	2PS 008 645-617	E1 1494	1LL 163 081-001	E1 1719	2RL 863 132-011
E1 1313	1LS 008 369-501	E1 1396	2PS 008 645-621	E1 1494	1LL 163 082-001	E1 1719	2RL 863 132-021
E1 1314	1LL 008 369-171	E1 1396	2PS 008 645-627	E1 1495	1LL 163 081-001	E1 1719	2RL 863 132-031
E1 1314	1LL 008 369-181	E1 1397	2PS 008 645-021	E1 1495	1LL 163 082-001	E1 17191	1LJ 007 235-251
E1 1314	1LL 008 369-271	E1 1397	2PS 008 645-257	E1 1502	1LB 996 157-201	E1 17192	1LJ 007 235-261
E1 1314	1LL 008 369-281	E1 1398	2PG 008 645-167	E1 151	2BM 003 647-021	E1 17193	9ES 140 721-015
E1 1314	1LL 009 260-091	E1 1398	2PG 008 645-561	E1 151	2BM 003 647-067	E1 17194	9ES 140 722-015
E1 1314	1LL 009 260-101	E1 1398	2PG 008 645-567	E1 151	2BM 003 647-801	E1 17199	9ES 145 599-001
E1 1314	1LL 009 260-571	E1 1398	2PG 008 645-631	E1 151	9EL 907 325-001	E1 17199	9ES 145 600-001
E1 1314	1LL 009 260-581	E1 1398	2PG 008 645-641	E1 151	9EL 907 326-001	E1 1721	2RL 863 106-001
E1 1314	1LS 008 369-491	E1 1398	2PG 008 645-917	E1 151	9EL 962 585-041	E1 1721	2RL 863 106-011
E1 1314	1LS 008 369-501	E1 1398	2PG 008 645-961	E1 151	9EL 962 586-041	E1 1722	2PT 008 935-001
E1 1325	1NB 008 275-031	E1 1398	2PG 008 645-967	E1 1516	1LG 246 041-031	E1 1722	2PT 008 935-011
E1 1325	1NB 008 275-041	E1 1398	2PG 008 645-971	E1 1517	1LG 246 041-041	E1 1722	2PT 008 935-017
E1 1325	1NB 008 275-071	E1 1398	2PG 008 645-977	E1 1518	1LG 246 041-031	E1 1722	2PT 008 935-801
E1 1325	1NB 008 275-081	E1 1398	2TM 008 645-061	E1 1519	1LG 246 041-041	E1 1722	2PT 008 935-811
E1 1327	1LR 246 046-531	E1 1398	2TM 008 645-067	E1 1524	1LH 246 047-031	E1 1722	2PT 009 305-801
E1 1327	1LR 246 046-541	E1 1398	2TM 008 645-071	E1 1524	1LH 246 047-071	E1 1722	2PT 009 305-811
E1 1328	1LR 246 046-531	E1 1398	2TM 008 645-077	E1 1525	1LH 246 047-041	E1 1722	2PT 009 305-821
E1 1328	1LR 246 046-541	E1 1398	2TM 008 645-081	E1 1525	1LH 246 047-081	E1 1740	1FE 008 773-011
E1 1342	1NO 008 582-001	E1 1398	2TM 008 645-087	E1 153	9EL 962 585-051	e1 1740	2RL 008 060-001
E1 1342	1NO 008 582-007	E1 1398	2TM 008 645-091	E1 153	9EL 962 586-051	e1 1740	2RL 008 060-011
E1 1342	1NO 008 582-011	E1 1398	2TM 008 645-651	E1 1559	1NO 247 003-011	e1 1740	2RL 008 060-101
E1 1342	1NO 008 582-017	E1 1398	2TM 008 645-661	E1 1559	1NO 247 003-021	e1 1740	2RL 008 060-111
E1 13463	8RA 002 010-011	E1 1398	2TM 008 645-941	E1 1563	1LL 008 875-811	e1 1740	2RL 008 061-001
E1 1353	9EL 964 949-001	E1 1398	2TM 008 645-947	E1 1564	1LL 008 875-811	e1 1740	2RL 008 061-011
E1 1353	9EL 964 950-001	E1 1398	2TM 008 645-951	E1 1571	2VP 008 427-091	e1 1740	2RL 008 061-101
E1 1356	1LL 008 320-251	E1 1398	2TM 008 645-957	E1 1571	2VP 008 427-101	e1 1740	2RL 008 061-111
E1 1356	1LL 008 320-261	E1 1399	2RL 008 181-001	E1 1589	1LE 270 600-191	e1 1740	2RL 008 062-001
E1 1356	1LL 008 320-331	E1 1399	2RL 008 181-011	E1 1590	1LE 270 600-201	e1 1740	2RL 008 062-011
E1 1356	1LL 008 320-341	E1 1399	2RL 008 181-101	E1 1591	1LE 270 600-191	e1 1740	2RL 008 062-101
E1 1357	1LL 008 320-251	E1 1399	2RL 008 181-111	E1 1592	1LE 270 600-201	e1 1740	2RL 008 062-111
E1 1357	1LL 008 320-261	E1 1399	2RL 008 182-001	E1 1655	1FE 008 773-001	e1 1740	2RL 008 063-001
E1 1357	1LL 008 320-331	E1 1399	2RL 008 182-011	E1 1655	1FE 008 773-041	e1 1740	2RL 008 063-011
E1 1357	1LL 008 320-341	E1 1399	2RL 008 182-101	E1 1655	1FE 008 773-061	e1 1740	2RL 008 063-101
E1 1364	2VP 008 759-051	E1 1399	2RL 008 182-111	E1 1655	1FE 161 641-011	e1 1740	2RL 008 063-111
E1 1364	2VP 008 759-061	E1 1399	2RL 008 183-001	E1 1655	1FE 161 641-021	e1 1740	2RL 008 065-001
E1 1395	2PG 008 645-167	E1 1399	2RL 008 183-011	E1 1655	1FE 161 642-011	e1 1740	2RL 008 065-011
E1 1395	2PG 008 645-561	E1 1399	2RL 008 183-101	E1 1655	1FE 161 644-011	e1 1740	2RL 008 065-101
E1 1395	2PG 008 645-567	E1 1399	2RL 008 183-111	E1 1663	1LL 009 476-031	e1 1740	2RL 008 065-107
E1 1395	2PG 008 645-631	E1 1399	9EL 862 140-031	E1 1663	1LL 009 476-041	e1 1740	2RL 008 065-111
E1 1395	2PG 008 645-641	E1 1419	2RL 008 965-001	E1 1668	2VA 964 957-011	E1 1741	1FE 008 773-021
E1 1395	2PG 008 645-917	E1 1419	2RL 008 965-011	E1 1668	2VA 964 957-021	E1 1741	1FE 008 773-051
E1 1395	2PG 008 645-961	E1 1419	2RL 008 965-021	E1 1678	1LL 008 934-011	E1 1741	1FE 161 576-011
E1 1395	2PG 008 645-967	E1 1419	2RL 008 966-001	E1 1678	1LL 008 934-031	E1 1748	1LG 247 007-031
E1 1395	2PG 008 645-971	E1 1419	2RL 008 966-021	E1 1689	1NE 008 773-031	E1 1748	1LG 247 007-041
E1 1395	2PG 008 645-977	E1 1419	2RL 008 967-001	E1 1696	2PF 008 405-051	E1 1748	1LG 247 007-191
E1 1395	2PS 008 645-001	E1 1419	2RL 008 967-011	E1 1696	2PF 008 405-057	E1 1748	1LG 247 007-201
E1 1395	2PS 008 645-007	E1 1419	2RL 008 967-021	E1 1696	2PF 008 405-061	E1 1748	1LG 247 007-231
E1 1395	2PS 008 645-011	E1 1419	2RL 008 990-001	E1 1696	2PF 008 405-067	E1 1748	1LG 247 007-241
E1 1395	2PS 008 645-187	E1 1419	2RL 008 990-011	E1 1696	2PF 008 405-127	E1 1753	1F8 006 800-401
E1 1395	2PS 008 645-497	E1 1419	2RL 008 990-021	E1 17001	9ES 120 725-001	E1 1753	1F8 007 560-201
E1 1395	2PS 008 645-601	E1 1423	2BM 008 771-001	E1 17002	9ES 120 726-001	E1 1753	1F8 007 560-211
E1 1395	2PS 008 645-607	E1 1423	2BM 008 771-007	E1 17009	1LE 003 427-041	E1 1754	1LL 008 881-431
E1 1395	2PS 008 645-611	E1 14464	1K3 114 155-001	E1 17016	1LG 003 434-187	E1 1754	1LL 008 881-441
E1 1395	2PS 008 645-617	E1 14464	1K3 126 046-001	E1 17016	1LG 003 434-237	E1 1755	1LE 008 880-031
E1 1395	2PS 008 645-621	E1 14464	1K3 126 680-001	E1 17016	9ES 122 221-007	E1 1755	1LE 008 880-041
E1 1395	2PS 008 645-627	E1 14464/1	1K3 126 046-001	E1 17031	1L3 002 850-068	E1 1755	1LL 008 881-431
E1 1395	2TM 008 645-061	E1 14464/1	1K3 126 680-001	E1 17031	1L3 005 649-017	E1 1755	1LL 008 881-441
E1 1395	2TM 008 645-067	E1 14520	1FE 002 537-191	E1 17088	1LG 004 679-051	E1 1765	2XD 009 051-001
E1 1395	2TM 008 645-071	E1 14520	9DF 112 247-001	E1 17116	1LA 004 109-217	E1 1765	2XD 009 051-011
E1 1395	2TM 008 645-077	E1 14521	1F4 002 608-001	E1 17116	1LA 004 109-227	E1 1765	2XD 009 051-021
E1 1395	2TM 008 645-081	E1 14540	1LH 002 658-451	E1 17119	1LE 003 427-041	E1 1765	2XD 009 051-031
E1 1395	2TM 008 645-087	E1 14540	1LH 002 658-511	E1 17133	9ES 133 383-005	E1 1765	2XD 009 052-001
E1 1395	2TM 008 645-091	E1 14540	9ES 113 919-001	E1 17134	9ES 133 384-005	E1 1765	2XD 009 052-011
E1 1395	2TM 008 645-651	E1 14540	9ES 118 403-001	E1 17135	1LG 005 480-031	E1 1765	2XD 009 053-001
E1 1395	2TM 008 645-661	E1 14541	1LH 002 658-461	E1 17135	1LG 005 480-075	E1 1765	2XD 009 054-001
E1 1395	2TM 008 645-941	E1 14541	1LH 002 658-521	E1 17135	9ES 133 571-005	E1 1770	1LG 270 370-331
E1 1395	2TM 008 645-947	E1 14541	9ES 113 918-001	E1 17136	1LG 005 480-041	E1 1770	1LG 270 370-341
E1 1395	2TM 008 645-951	E1 14541	9ES 118 402-001	E1 17136	9ES 133 572-005	E1 1770	1LG 270 370-631
E1 1395	2TM 008 645-957	E1 1480	2SK 964 596-011	E1 17149	1LH 005 454-311	E1 1770	1LG 270 370-641

Type Approval Numbers



E1 1771	1LG 270 370-331	e1 18411	2NE 003 236-307	E1 1928	1F8 009 797-321	E1 21353	8RA 002 014-032
E1 1771	1LG 270 370-341	e1 18411	2NE 004 432-011	E1 1928	1F8 009 797-331	E1 21353	8RA 002 014-041
E1 1771	1LG 270 370-631	e1 18411	2SA 004 431-071	E1 1928	1F8 009 797-341	E1 21353	8RA 002 014-048
E1 1771	1LG 270 370-641	e1 18411	9EL 119 544-001	E1 1928	1F8 009 797-351	E1 21353	8RA 002 014-051
e1 1774	2RL 008 364-021	E1 18421	2NE 003 734-091	E1 1928	1F8 009 797-421	E1 21353	8RA 002 014-052
e1 1775	2RL 008 366-021	E1 18430	9EL 131 613-031	E1 1928	1F8 009 797-431	E1 21353	8RA 002 014-831
e1 1775	2RL 008 366-031	E1 18430	9EL 131 614-031	E1 1949	2VP 982 006-011	E1 21353	8RA 002 014-832
E1 1776	9EL 160 467-011	E1 18430	9EM 131 613-021	E1 1949	2VP 982 006-021	E1 21353	8RA 002 014-842
E1 1776	9EL 160 468-011	E1 18430	9EM 131 614-021	E1 1951	1NO 009 295-011	E1 21353	8RA 002 014-851
E1 1787	2BA 247 015-031	E1 18432	2NR 005 190-071	E1 1951	1NO 009 295-021	E1 21353	8RA 002 014-852
E1 1787	2BA 247 015-041	E1 18437	2NR 005 554-111	E1 1951	1NO 009 295-031	E1 21399	2RL 863 123-001
E1 1788	2BA 247 016-031	E1 18437	2NR 005 554-121	E1 1951	1NO 009 295-037	E1 21399	2RL 863 123-011
E1 1788	2BA 247 016-041	E1 18441	9EL 146 373-001	E1 1951	1NO 009 295-041	E1 21399	8RA 003 326-001
E1 1789	2SA 965 038-031	E1 18444	9EL 138 463-031	E1 1951	1NO 009 295-047	E1 21399	8RA 003 326-002
E1 1789	2SA 965 038-041	E1 18444	9EL 138 464-031	E1 1951	1NO 009 295-057	E1 21399	8RA 003 326-011
E1 1789	2VP 965 037-051	E1 1848	2BM 008 355-017	E1 1951	1NO 009 295-067	E1 21399	8RA 003 326-017
E1 1789	2VP 965 037-061	E1 1869	2NE 964 962-041	E1 1951	1NO 009 295-801	E1 21399	8RA 003 326-021
E1 1814	1LS 008 821-331	E1 1869	2ZR 964 962-031	E1 1951	1NO 009 436-801	E1 2140	2RL 008 965-031
E1 1814	1LS 008 821-341	E1 1877	1LL 247 010-311	E1 196	2SD 001 699-061	E1 2140	2RL 008 965-041
E1 18206	1NL 005 230-111	E1 1877	1LL 247 010-321	E1 196	2SD 001 699-511	E1 2140	2RL 008 966-031
E1 18206	1NL 005 230-121	E1 1877	1LL 247 010-331	E1 196	2SE 001 699-071	E1 2140	2RL 008 967-031
E1 18208	1NL 005 150-051	E1 1877	1LL 247 010-341	E1 196	9EL 109 139-001	E1 2140	2RL 008 967-041
E1 18208	1NL 005 150-061	E1 1877	1LL 247 010-391	E1 1975	1LE 247 019-191	E1 2140	2RL 008 990-001
E1 18209	1NB 005 394-051	E1 1877	1LL 247 010-401	E1 1975	1LE 247 019-201	E1 2140	2RL 008 990-011
E1 18209	1NB 005 394-061	E1 1878	1LL 247 010-311	E1 198	2DA 007 421-001	E1 21406	2DA 003 734-011
E1 18210	1NL 005 566-051	E1 1878	1LL 247 010-321	E1 198	2DA 007 421-007	E1 21406	9EL 123 632-001
E1 18210	1NL 005 566-061	E1 1878	1LL 247 010-331	E1 1981	2XD 007 854-801	E1 2141	2XD 009 052-021
E1 18213	1N4 005 750-001	E1 1878	1LL 247 010-341	E1 1981	2XD 007 854-811	E1 2141	2XD 009 052-031
E1 18213	1N4 005 750-041	E1 1878	1LL 247 010-391	E1 1981	2XD 007 854-821	E1 2141	2XD 009 053-021
E1 18213	1N4 005 750-801	E1 1878	1LL 247 010-401	E1 1981	2XD 007 854-831	E1 21434	2DA 001 423-077
E1 18213	1N4 135 224-011	E1 1885	9EL 161 421-011	E1 1981	2XD 861 423-011	E1 21441	2XS 004 237-311
E1 18216	1ND 003 590-401	E1 1885	9EL 161 422-011	E1 1981	2XD 861 423-021	E1 21441	2XS 004 237-321
E1 18216	1ND 005 700-001	e1 1889	2RL 008 181-001	E1 1982	2XD 008 135-801	E1 215	1NE 007 517-051
E1 18216	1ND 005 700-021	e1 1889	2RL 008 181-011	E1 1982	2XD 008 135-811	E1 215	1NE 007 517-061
E1 18216	1ND 005 700-061	e1 1889	2RL 008 181-101	E1 1982	2XD 008 135-821	E1 21624	2PF 001 259-631
E1 18216	1ND 005 700-841	e1 1889	2RL 008 181-111	E1 1982	2XD 008 135-831	E1 21624	2PF 001 259-677
E1 18216	1ND 136 933-011	e1 1889	2RL 008 182-001	E1 1982	2XD 862 019-011	E1 21624	2PF 001 259-687
E1 18221	1NL 005 230-111	e1 1889	2RL 008 182-011	E1 1982	2XD 862 111-011	E1 21624	9EL 109 208-011
E1 18221	1NL 005 230-121	e1 1889	2RL 008 182-101	E1 199	2DA 007 421-017	E1 21626	2PF 003 057-001
E1 18226	1NL 006 315-051	e1 1889	2RL 008 182-111	E1 199	2DA 007 421-027	E1 21626	2PF 003 057-002
E1 18226	1NL 006 315-061	e1 1889	2RL 008 183-001	E1 20	1NL 007 186-027	E1 21626	2PF 003 057-041
E1 18227	1NB 005 860-021	e1 1889	2RL 008 183-011	E1 20	1NL 007 186-047	E1 21626	9EL 117 330-001
E1 18227	1NB 005 860-131	e1 1889	2RL 008 183-101	E1 20	1NL 007 186-061	E1 21629	2PG 003 057-011
E1 18227	1NB 005 860-801	e1 1889	2RL 008 183-111	E1 20	1NL 007 186-067	E1 21629	2PG 003 057-067
E1 18227	1NB 137 001-021	E1 1892	2SB 008 405-091	E1 2042	1PE 965 410-111	E1 21629	9EL 117 334-001
E1 18231	1NE 006 300-011	E1 1892	2SB 008 405-101	E1 2042	1PE 965 410-121	E1 21639	2PF 003 389-037
E1 18231	1NE 006 300-051	E1 1901	1F1 009 094-041	E1 2045	2SK 009 467-111	E1 21647	2PF 003 734-031
E1 18231	1NE 006 300-101	E1 1901	1F1 009 094-051	E1 2045	2SK 009 467-121	E1 21656	2PF 004 081-001
E1 18231	1NE 006 300-201	E1 1901	1F1 161 825-021	E1 2077	1LL 009 260-091	E1 21656	2PF 004 081-007
E1 18231	1NE 006 300-231	E1 1901	1F3 009 094-021	E1 2077	1LL 009 260-101	E1 21656	2PF 004 081-017
E1 18231	1NE 138 555-011	E1 1901	1F3 009 094-031	E1 2077	1LL 009 260-571	E1 21656	2PF 004 081-107
E1 18232	1NL 006 250-051	E1 1901	1F3 009 094-171	E1 2077	1LL 009 260-581	E1 21656	2PF 004 081-117
E1 18232	1NL 006 250-061	E1 1901	1F3 010 119-011	E1 2077	1ZT 009 260-671	E1 21668	2XS 004 237-291
E1 18234	1NL 006 280-051	E1 1901	1F3 010 119-021	E1 2077	1ZT 009 260-681	E1 21668	2XS 004 237-301
E1 18234	1NL 006 280-061	E1 1901	1F3 161 825-011	E1 2087	1F3 009 094-142	E1 21670	2XS 003 738-037
E1 18235	1NL 006 150-071	E1 1901	1F3 161 825-081	E1 2087	1F3 009 094-311	E1 21682	2PG 003 748-151
E1 18235	1NL 006 150-081	E1 1901	1N3 009 094-001	E1 2087	1F3 161 825-071	E1 21682	9EL 148 274-001
E1 18236	1NB 006 270-051	E1 1901	1N3 009 094-011	E1 2088	2NR 982 008-111	E1 21688	2PF 002 860-031
E1 18236	1NB 006 270-061	E1 1901	1N3 161 825-001	E1 2088	2NR 982 008-121	E1 21688	9EL 116 380-035
E1 18238	1NL 007 220-031	E1 1902	1F1 009 094-091	E1 2090	2VP 009 500-811	E1 21690	1VB 005 444-037
E1 18238	1NL 007 220-041	E1 1902	1F1 161 825-041	E1 2100	1LR 247 017-071	E1 21691	2PF 006 679-007
E1 18239	1NL 006 580-051	E1 1902	1F3 009 094-061	E1 2101	1LR 247 017-081	E1 21693	2PF 001 647-031
E1 18239	1NL 006 580-061	E1 1902	1F3 009 094-071	E1 2105	1LJ 009 250-771	E1 21693	2PF 001 647-037
E1 18242	1NL 005 150-111	E1 1902	1F3 010 119-001	E1 2105	1LJ 009 250-781	e1 2181	2RL 006 846-001
E1 18242	1NL 005 150-121	E1 1902	1F3 161 825-031	E1 2113	2XD 008 997-101	e1 2181	2RL 006 846-011
E1 18245	1F8 161 326-011	E1 1927	9EL 982 000-051	E1 2113	2XD 009 048-101	e1 2181	2RL 006 846-101
E1 18245	1N8 006 800-001	E1 1927	9EL 982 000-061	E1 2113	2XD 009 475-001	e1 2181	2RL 006 846-111
E1 18245	1N8 007 560-021	E1 1927	9EL 982 001-111	E1 2113	2XD 009 475-011	e1 2181	2RL 007 337-001
E1 18245	1N8 007 560-031	E1 1927	9EL 982 001-121	E1 2113	2XD 009 475-021	e1 2181	2RL 007 337-011
E1 18245	1N8 142 350-011	E1 1928	1F8 006 800-301	E1 2113	2XD 009 475-031	e1 2181	2RL 007 337-021
E1 18245	1N8 148 103-011	E1 1928	1F8 006 800-311	E1 2120	2SK 009 466-131	e1 2181	2RL 007 337-031
E1 1836	1LB 247 011-051	E1 1928	1F8 006 800-321	E1 2120	2SK 009 466-141	e1 2181	2RL 007 337-041
E1 1837	1LB 247 011-061	E1 1928	1F8 007 560-301	E1 213	2SD 002 514-161	e1 2181	2RL 007 337-101
E1 1838	1LB 247 011-051	E1 1928	1F8 007 560-311	E1 213	2SE 002 514-171	e1 2181	2RL 007 337-111
E1 1839	1LB 247 011-061	E1 1928	1F8 007 560-321	E1 213	9EL 119 614-031	e1 2181	2RL 007 337-121
E1 18406	2NE 003 030-151	E1 1928	1F8 009 797-021	E1 21340	8RL 002 009-001	e1 2182	2RL 007 550-001
e1 18411	2NE 003 236-001	E1 1928	1F8 009 797-031	E1 21340	8RL 002 009-011	e1 2182	2RL 007 550-011
e1 18411	2NE 003 236-008	E1 1928	1F8 009 797-101	E1 21340	8RL 002 009-021	e1 2182	2RL 007 550-021
e1 18411	2NE 003 236-301	E1 1928	1F8 009 797-111	E1 21353	8RA 002 014-031	e1 2182	2RL 007 551-001



Type Approval Numbers

e1 2182	2RL 007 551-011	E1 2307	1LL 009 449-041	E1 2528	1ZS 247 047-351	E1 27025	1LF 006 826-261
e1 2182	2RL 007 551-021	E1 2307	1LL 164 909-001	E1 2528	1ZS 247 047-361	E1 27026	1LH 006 840-271
e1 2182	2RL 007 552-001	E1 2307	1LL 164 910-001	E1 2529	1FA 010 047-001	E1 27027	1LH 006 840-281
e1 2182	2RL 007 552-011	E1 2307	1ZS 169 009-131	E1 2529	1FA 010 047-011	E1 27054	1LF 006 826-251
e1 2182	2RL 007 552-021	E1 2307	1ZS 169 009-141	E1 2529	1FA 010 047-801	E1 27055	1LF 006 826-261
e1 2182	2RL 007 553-001	E1 2318	9EL 113 065-001	E1 2529	1NA 010 047-101	E1 27111	1ZT 009 647-351
e1 2182	2RL 007 553-011	E1 2334	2SK 010 083-801	E1 2529	1NA 010 047-111	E1 27111	1ZT 009 647-361
e1 2182	2RL 007 553-021	E1 2344	2PT 009 496-007	E1 2529	1NA 010 047-811	E1 2714	1LE 247 051-031
E1 2185	2ZR 005 700-191	E1 2344	2PT 009 496-801	E1 2544	2XS 340 000-101	E1 2714	1LE 247 051-041
E1 2186	2ZR 005 860-151	E1 237	2VA 005 553-131	E1 2554	1F8 007 560-621	E1 2715	1LE 247 051-031
E1 2198	1KL 009 486-001	E1 237	2VA 005 553-141	E1 2554	1F8 007 560-631	E1 2715	1F8 007 560-631
E1 2243	2RL 863 123-001	E1 2372	2PT 009 599-011	E1 2572	1LJ 009 925-031	E1 2718	1ZT 009 647-351
E1 2243	2RL 863 123-011	E1 2372	2PT 009 599-021	E1 2572	1LJ 009 925-041	E1 2718	1ZT 009 647-361
E1 2254	1F8 009 797-121	E1 2372	2PT 009 599-031	E1 2573	1LJ 009 925-031	E1 2720	1LR 010 117-111
E1 2254	1F8 009 797-131	E1 2372	2PT 009 599-041	E1 2573	1LJ 009 925-041	E1 2720	1LR 010 117-121
E1 2255	1F8 007 560-721	E1 2372	2PT 009 599-801	E1 2578	2PT 010 043-011	E1 2721	1LR 010 117-111
E1 2255	1F8 007 560-731	E1 2372	2PT 010 177-801	E1 2578	2PT 010 043-021	E1 2721	1LR 010 117-121
E1 2255	1F8 165 949-011	E1 2372	2PT 010 177-811	E1 2578	2PT 010 043-031	E1 273	2SD 002 776-231
E1 227	1L9 007 095-111	E1 2397	1K0 247 043-001	E1 2578	2PT 010 043-041	E1 273	2SD 002 776-237
E1 227	1L9 007 095-121	E1 2397	1K0 247 043-007	E1 2578	2PT 010 043-801	E1 273	2SD 002 776-241
E1 227	1L9 378 158-001	E1 2397	1K0 247 043-011	E1 2578	2PT 010 047-201	E1 273	2SD 002 776-247
E1 227	1L9 378 159-001	E1 2397	1K0 247 043-017	E1 2578	2PT 010 047-211	E1 273	2SE 002 776-211
E1 22764	2BA 001 275-011	E1 2397	1K0 247 043-021	E1 2578	2PT 010 047-821	E1 273	2SE 002 776-217
E1 22764	2BA 001 275-021	E1 2397	1K0 247 043-027	E1 2586	2BE 010 102-001	E1 273	2SE 002 776-221
E1 22764	9EL 101 899-001	E1 2397	1K0 247 043-031	E1 2586	2BE 010 102-011	E1 273	9EL 134 739-001
E1 22764	9EL 101 900-001	E1 2397	1K0 247 043-037	E1 2586	2BE 010 102-101	E1 273	9EL 134 740-001
E1 22786	2BA 001 240-301	E1 2397	1K0 247 043-117	E1 2596	1LL 010 800-031	E1 273	9EL 137 307-001
E1 22786	9EM 128 229-011	E1 2397	1K0 247 043-127	E1 2596	1LL 010 800-041	E1 273	9EL 137 308-001
E1 22796	2BA 001 277-011	E1 2397	1K0 247 043-137	E1 2596	1ZT 010 800-211	E1 2738	2XD 010 311-001
E1 22796	2BA 001 277-021	E1 2397	1K0 247 043-147	E1 2596	1ZT 010 800-221	E1 2738	2XD 010 311-011
E1 22803	2KA 003 102-011	E1 2397	1K0 247 043-157	E1 2597	1LL 010 800-031	E1 2738	2XD 010 311-021
E1 22808	2KA 003 168-021	E1 2397	1K0 247 043-167	E1 2597	1LL 010 800-041	E1 277	1L9 378 176-001
E1 22810	2KA 002 445-111	E1 2397	1ML 247 042-187	E1 2597	1ZT 010 800-211	E1 277	1L9 378 177-001
E1 22810	2KA 002 445-171	E1 2397	1ML 247 042-207	E1 2597	1ZT 010 800-221	E1 2796	2XD 010 312-801
E1 22819	2KA 003 389-001	E1 2398	1K0 247 043-117	E1 2598	1LG 009 767-031	E1 2796	2XD 010 312-811
E1 22819	2KA 003 389-011	E1 2398	1K0 247 043-127	E1 2598	1LG 009 767-041	E1 280	2PS 003 057-051
E1 22819	2KA 003 389-061	E1 2398	1K0 247 043-137	E1 2599	1LG 009 767-031	E1 280	2PS 003 057-052
E1 22819	2KA 003 389-062	E1 2398	1K0 247 043-147	E1 2599	1LG 009 767-041	E1 280	2PS 003 057-057
E1 22819	2KA 003 389-068	E1 2398	1K0 247 043-157	E1 2609	2KA 010 278-011	E1 280	2VD 007 500-111
E1 22819	2KA 003 389-081	E1 2398	1K0 247 043-167	E1 2609	2KA 010 278-021	E1 280	2VD 007 500-201
E1 22819	2KA 003 389-211	E1 2398	1ML 247 042-187	E1 2609	2KA 010 278-111	E1 280	2VD 007 500-221
E1 22819	2KA 003 389-217	E1 2398	1ML 247 042-207	E1 2609	2KA 010 278-121	E1 280	2VD 007 500-411
E1 22824	2KA 003 485-021	E1 240	2DA 003 236-031	E1 2609	2KA 010 278-311	E1 280	2VP 007 500-421
E1 22831	2SE 003 184-011	E1 240	2DA 003 236-037	E1 2609	2KA 010 278-321	E1 280	9EL 117 334-021
E1 22831	2SE 003 184-017	E1 240	2DA 003 236-331	E1 2609	2KA 010 278-327	E1 280	9EL 134 296-041
E1 22831	2SE 003 184-101	E1 240	2DB 004 431-061	E1 2609	2KA 010 278-411	E1 280	9EL 134 296-051
E1 22848	2KA 004 331-061	E1 240	9EL 119 544-031	E1 2609	2KA 010 278-421	E1 280	9EL 134 301-001
E1 22848	2KA 004 331-067	E1 241	2DA 005 200-321	E1 2610	1ZT 009 647-351	E1 280	9EL 134 301-011
E1 22851	2KA 004 434-031	E1 2417	1LH 009 513-051	E1 2610	1ZT 009 647-361	E1 2812	1LG 009 627-031
E1 22859	9EL 119 544-021	E1 2417	1LH 009 513-061	E1 2620	1ZT 010 800-211	E1 2812	1LG 009 627-041
E1 22859	9EL 119 544-101	E1 2417	1LH 009 513-071	E1 2620	1ZT 010 800-221	E1 2813	1LG 009 627-031
E1 22861	2KA 004 525-001	E1 2417	1LH 009 513-081	E1 2622	1LJ 009 630-331	E1 2813	1LG 009 627-041
E1 22870	2KA 004 983-011	E1 2418	1LH 009 513-051	E1 2622	1LJ 009 630-341	E1 2820	1LG 010 011-331
E1 22871	2KA 005 049-008	E1 2418	1LH 009 513-061	E1 2623	1LJ 009 630-331	E1 2820	1LG 010 011-341
E1 22871	2KA 005 049-011	E1 2418	1LH 009 513-071	E1 2623	1LJ 009 630-341	E1 2820	1LG 010 011-391
E1 22871	2KA 005 049-017	E1 2418	1LH 009 513-081	E1 2623	1ZT 009 631-311	E1 2820	1LG 010 011-401
E1 22890	2KA 004 331-031	E1 242	2DA 003 014-031	E1 2623	1ZT 009 631-321	E1 2820	1ZT 010 012-411
E1 22890	2KA 004 331-107	E1 242	2DA 003 014-037	E1 264	2SD 003 167-011	E1 2820	1ZT 010 012-421
E1 229	1L9 007 095-111	E1 243	2SD 004 431-011	E1 264	2SD 003 167-021	E1 2821	1LG 010 011-331
E1 229	1L9 378 158-001	E1 243	9EL 119 544-021	E1 264	2SD 003 167-531	E1 2821	1LG 010 011-341
E1 229	1L9 378 159-001	E1 2439	2PF 340 000-111	E1 264	2SD 003 167-541	E1 2821	1LG 010 011-391
E1 229	1L9 378 176-001	E1 2439	2PG 340 000-121	E1 264	2SE 003 167-031	E1 2821	1LG 010 011-401
E1 229	1L9 378 177-001	E1 24460	1LB 006 277-137	E1 264	2SE 003 167-041	E1 285	9EL 146 293-031
E1 22902	2KA 001 388-051	E1 24460	1VB 005 444-037	E1 264	9EL 147 747-001	E1 285	9EL 146 294-031
E1 22910	2KA 006 896-001	E1 24461	1LB 006 277-137	E1 264	9EL 147 747-007	E1 2886	1LL 010 131-031
E1 22910	2KA 006 896-007	E1 24461	1VB 005 444-037	E1 2671	1LL 009 933-431	E1 2886	1LL 010 131-041
E1 22916	2KA 003 738-057	E1 24504	1KB 003 177-061	E1 2671	1LL 009 933-441	E1 2887	1LL 010 131-031
e1 2293	2RL 863 132-001	E1 24504	1KB 003 177-597	E1 2672	1LL 009 933-431	E1 2887	1LL 010 131-041
E1 230	1L9 007 095-121	E1 24504	1VB 005 444-037	E1 2672	1LL 009 933-441	E1 2887	1LL 010 131-531
E1 230	1L9 378 158-001	E1 24565	1F6 003 939-031	E1 2680	1FO 010 293-001	E1 2887	1LL 010 131-541
E1 230	1L9 378 159-001	E1 24586	1FE 125 510-011	E1 2681	1NO 010 294-001	E1 2887	1ZS 010 131-631
E1 2300	2PF 009 514-001	E1 249	8RA 007 051-031	E1 2681	1NO 010 294-011	E1 2887	1ZS 010 131-641
E1 2300	2PF 009 514-011	E1 249	8RA 007 051-041	E1 27001	1LJ 006 360-671	E1 2905	1LL 010 335-071
E1 2306	1LL 009 449-031	E1 2502	1LJ 009 696-731	E1 27001	1LL 009 213-031	E1 2905	1LL 010 335-081
E1 2306	1LL 164 909-001	E1 2502	1LJ 009 696-741	E1 27002	1LJ 006 360-681	E1 2906	1LL 010 335-071
E1 2306	1LL 164 910-001	E1 2514	1LJ 009 648-031	E1 27002	1LL 009 213-041	E1 2906	1LL 010 335-081
E1 2306	1ZS 169 009-131	E1 2515	1LJ 009 648-031	E1 27007	1LD 962 060-131	E1 291	2PS 003 748-121
E1 2306	1ZS 169 009-141	E1 2527	1ZS 247 047-351	E1 27008	1LD 962 060-141	E1 291	2PS 003 748-127
E1 2307	1LL 009 449-031	E1 2527	1ZS 247 047-361	E1 27024	1LF 006 826-251	E1 291	2PS 003 748-161

Type Approval Numbers



E1 291	2PS 003 748-167	E1 31290	8RA 002 016-111	E1 31445	2SE 003 182-011	E1 32779	2BM 001 313-821
E1 291	2PS 003 748-177	E1 31291	8RA 002 015-001	E1 31445	2SE 003 182-017	E1 32781	2BA 003 411-001
E1 291	9EL 147 910-001	E1 31291	8RA 002 015-021	E1 31445	2SE 003 182-021	E1 32785	2BA 002 652-051
E1 2918	1LD 010 417-351	E1 31291	8RA 002 015-031	E1 31445	2SE 003 182-027	E1 32785	2BM 002 652-071
E1 2918	1LD 010 417-361	E1 31298	8RA 003 734-101	E1 31445	9EL 118 613-001	E1 32785	2BM 002 652-081
E1 2918	1LL 010 417-391	E1 31315	2PG 003 057-011	E1 31445	9EL 118 614-011	E1 32798	9EL 122 377-011
E1 2918	1LL 010 417-401	E1 31315	2PG 003 057-067	E1 31446	2PF 961 167-021	e1 3312	2RL 863 132-011
E1 2918	1ZL 010 417-431	E1 31315	2PS 003 057-051	E1 31446	9EL 137 241-001	E1 332	2DA 007 592-101
E1 2918	1ZL 010 417-441	E1 31315	2PS 003 057-052	E1 31450	2PF 001 638-067	E1 340	2SB 005 603-137
E1 2919	1LD 010 417-351	E1 31315	2PS 003 057-057	E1 31450	2SA 001 638-021	E1 343	2DA 007 541-001
E1 2919	1LD 010 417-361	E1 31315	2TM 003 057-031	E1 31450	9EL 107 443-061	E1 34447	1K2 006 147-031
E1 2920	1LL 010 417-391	E1 31315	9EL 117 334-001	E1 31451	2SA 002 860-041	E1 34447	1K2 006 147-041
E1 2920	1LL 010 417-401	E1 31315	9EL 117 334-021	E1 31451	9EL 116 380-045	E1 34447	1K2 006 147-051
E1 2920	1ZL 010 417-431	E1 31407	2XS 005 020-001	E1 31452	2SW 003 014-131	E1 34517	1FE 005 478-011
E1 2920	1ZL 010 417-441	E1 31407	2XS 005 020-002	E1 31452	2SY 003 014-121	E1 34517	1FE 005 478-021
E1 2921	1LL 010 417-391	E1 31407	2XS 005 020-003	E1 31452	9EL 115 003-001	E1 34553	1F7 004 700-431
E1 2921	1LL 010 417-401	E1 31407	2XS 005 020-011	E1 31452	9EL 115 003-011	E1 34572	1DL 005 930-371
E1 2921	1ZL 010 417-431	E1 31407	2XS 005 020-017	E1 31453	2SB 003 014-151	E1 34572	1DL 005 930-381
E1 2921	1ZL 010 417-441	E1 31407	2XS 005 020-021	E1 31453	2ST 003 014-141	E1 34572	1K3 132 253-011
E1 2923	1LL 010 551-041	E1 31407	2XS 005 020-041	E1 31453	9EL 115 003-021	E1 34572	1K3 132 266-011
e1 2954	2RL 008 965-001	E1 31407	2XS 005 020-047	E1 31453	9EL 115 003-035	E1 34572	1K3 134 855-011
e1 2954	2RL 008 965-011	E1 31407	2XS 005 020-057	E1 31468	2SA 961 167-011	E1 34572	1K3 134 856-011
e1 2954	2RL 008 965-021	E1 31407	2XS 005 020-067	E1 31470	2SA 006 679-027	E1 348	1F7 004 700-431
e1 2954	2RL 008 965-031	E1 31407	2XS 005 020-077	E1 31482	2SD 001 680-271	e1 3486	2RL 007 017-041
e1 2954	2RL 008 965-041	E1 31407	2XS 005 020-081	E1 31482	2SD 001 680-281	e1 3486	2RL 007 017-051
e1 2954	2RL 008 966-001	E1 31407	2XS 005 020-091	E1 31482	2SD 001 680-391	e1 3486	2RL 007 017-061
e1 2954	2RL 008 966-021	E1 31407	2XS 005 020-111	E1 31482	2SD 001 680-401	e1 3486	2RL 007 017-071
e1 2954	2RL 008 966-031	E1 31407	2XS 005 020-121	E1 31482	2SE 001 680-291	e1 3486	2RL 863 123-001
e1 2954	2RL 008 967-001	E1 31407	2XS 005 020-137	E1 31482	2SE 001 680-301	e1 3486	2RL 863 123-011
e1 2954	2RL 008 967-011	E1 31407	2XS 005 020-147	E1 31482	9EL 107 368-001	e1 3486	2XD 009 051-001
e1 2954	2RL 008 967-021	E1 31407	9EL 132 215-001	E1 31482	9EL 111 647-001	e1 3486	2XD 009 051-011
e1 2954	2RL 008 967-031	E1 31407	9EL 132 215-011	E1 31483	9EL 006 220-921	e1 3486	2XD 009 051-021
e1 2954	2RL 008 967-041	E1 31410	2PG 003 748-151	E1 32611	2BA 001 221-031	e1 3486	2XD 009 051-031
e1 2954	2RL 008 990-001	E1 31410	2PS 003 748-121	E1 32611	2BA 001 221-041	e1 3486	2XD 009 052-001
e1 2954	2RL 008 990-011	E1 31410	2PS 003 748-127	E1 32611	9EL 110 013-001	e1 3486	2XD 009 052-011
e1 2954	2RL 008 990-021	E1 31410	2PS 003 748-161	E1 32611	9EL 110 014-001	e1 3486	2XD 009 052-021
E1 297	1LL 007 250-011	E1 31410	2PS 003 748-167	E1 32617	2BA 001 416-011	e1 3486	2XD 009 052-031
E1 297	1LL 007 250-021	E1 31410	2PS 003 748-177	E1 32617	2BA 001 416-021	e1 3486	2XD 009 053-001
E1 297	9ES 152 179-001	E1 31410	2TM 003 748-011	E1 32617	9EL 110 736-001	e1 3486	2XD 009 053-021
E1 297	9ES 152 179-801	E1 31410	9EL 147 910-001	E1 32617	9EL 110 737-001	e1 3486	2XD 009 054-001
E1 298	1LL 007 250-011	E1 31410	9EL 148 274-001	E1 32619	2BA 003 014-011	E1 352	1S0 001 430-011
E1 298	1LL 007 250-021	E1 31416	2SA 001 634-121	E1 32619	9EL 110 536-001	E1 353	9EL 963 261-011
E1 298	9ES 152 179-801	E1 31416	2TJ 001 633-211	E1 32621	2BA 002 324-011	E1 353	9EL 963 262-011
E1 298	9ES 152 180-001	E1 31416	9EL 132 403-001	E1 32621	2BA 002 324-021	e1 35517	2XD 010 311-001
E1 2989	2RL 010 743-001	E1 31416	9EL 132 404-001	E1 32621	9EL 110 918-001	e1 35517	2XD 010 311-011
E1 2989	2RL 010 743-011	E1 31417	2TJ 003 168-151	E1 32621	9EL 110 918-011	e1 35517	2XD 010 311-021
E1 2989	2RL 010 743-021	E1 31418	2SA 003 014-051	E1 32623	2BA 002 324-001	E1 356	1LG 007 660-031
E1 2989	2RL 010 743-031	E1 31418	9EL 110 540-001	E1 32623	9EL 110 910-001	E1 356	1LG 007 660-111
E1 2989	2RL 010 743-041	E1 31422	2DA 005 603-031	E1 32633	2BA 001 234-251	E1 356	9ES 147 313-011
E1 2989	2RL 010 743-051	E1 31422	2DA 005 603-037	E1 32633	2BA 001 234-261	E1 356	9ES 147 315-015
E1 2989	2RL 010 743-071	E1 31422	2DA 005 603-237	E1 32633	9EL 109 440-002	E1 357	1LG 007 660-041
E1 2989	2RL 010 743-081	E1 31423	2SA 005 603-021	E1 32639	2BM 001 318-001	E1 357	1LG 007 660-121
E1 2989	2RL 010 743-091	E1 31423	2SA 005 603-027	E1 32661	2BA 003 014-111	E1 357	9ES 147 314-011
E1 2989	2RL 010 743-101	E1 31423	2SA 005 603-227	E1 32661	9EL 110 536-011	E1 357	9ES 147 316-015
E1 2989	2RL 010 743-111	E1 31432	2VD 005 300-551	E1 32692	2BM 002 847-011	e1 35947	2RL 010 743-001
E1 2989	2RL 010 743-121	E1 31432	2VD 005 300-581	E1 32692	2BM 002 847-021	e1 35947	2RL 010 743-011
E1 2989	2RL 010 743-131	E1 31432	2VD 007 500-091	E1 32692	9EL 115 830-001	e1 35947	2RL 010 743-021
E1 2992	1LL 010 551-031	E1 31432	2VD 007 500-111	E1 32710	2BA 002 939-171	e1 35947	2RL 010 743-031
E1 2992	1LL 010 551-041	E1 31432	2VD 007 500-201	E1 32710	9EL 116 771-031	e1 35947	2RL 010 743-041
E1 2993	1LL 010 551-031	E1 31432	2VD 007 500-221	E1 32719	2BA 003 022-001	e1 35947	2RL 010 743-051
E1 29K	8GH 008 358-241	E1 31432	2VD 007 500-411	E1 32719	2BA 003 022-021	e1 35947	2RL 010 743-061
E1 2LR	8GP 002 067-241	E1 31432	2VP 007 500-421	E1 32719	2BA 003 022-057	e1 35947	2RL 010 743-071
E1 30	1LJ 007 219-371	E1 31432	9EL 134 296-041	E1 32719	2XD 003 022-061	e1 35947	2RL 010 743-081
E1 303	1F8 006 800-331	E1 31432	9EL 134 296-051	E1 32719	9EL 116 907-001	e1 35947	2RL 010 743-091
E1 303	1F8 006 800-341	E1 31432	9EL 134 301-001	E1 32744	2BA 003 110-011	e1 35947	2RL 010 743-101
E1 303	1F8 006 800-351	E1 31432	9EL 134 301-011	E1 32744	2BA 003 110-021	e1 35947	2RL 010 743-111
E1 303	1F8 006 800-361	E1 31433	2SA 003 734-121	E1 32744	9EL 120 651-001	e1 35947	2RL 010 743-121
E1 303	1F8 007 560-011	E1 31433	9EL 135 060-001	E1 32744	9EL 120 652-001	e1 35947	2RL 010 743-131
E1 303	1F8 007 560-341	E1 31436	2SD 001 693-011	E1 32757	2BA 003 197-011	e1 3686	2XD 008 997-001
E1 303	1F8 148 009-011	E1 31438	2SA 001 259-751	E1 32757	2BA 003 197-021	e1 3686	2XD 008 997-101
E1 303	1F8 148 131-011	E1 31438	2SA 001 259-757	E1 32764	2BA 003 236-021	e1 3686	2XD 009 048-001
E1 303	1F8 165 940-011	E1 31438	9EL 135 266-001	E1 32764	2BA 003 236-027	e1 3686	2XD 009 048-101
E1 303	1F8 165 941-011	E1 31443	2SA 004 431-071	E1 32764	2BA 003 236-177	e1 3686	2XD 009 475-001
E1 303	1F8 165 942-011	E1 31443	2SA 005 200-331	E1 32764	2BA 003 236-321	e1 3686	2XD 009 475-011
E1 303	1F8 165 943-011	E1 31443	9EL 119 544-001	E1 32764	2DB 004 431-061	e1 3686	2XD 009 475-021
E1 303	1F8 165 947-011	E1 31445	2SD 003 182-051	E1 32764	2SD 004 431-011	e1 3686	2XD 009 475-031
E1 31	1LJ 007 219-381	E1 31445	2SD 003 182-057	E1 32764	9EL 119 544-021	e1 3829	2RL 863 106-001
E1 31242	8RA 003 660-007	E1 31445	2SD 003 182-061	E1 32779	2BM 001 313-001	e1 3829	2RL 863 106-011
E1 31290	8RA 002 016-101	E1 31445	2SD 003 182-067	E1 32779	2BM 001 313-002	e1 3829	2RL 863 123-001



Type Approval Numbers

e1 3829	2RL 863 123-011	E1 42796	9EL 144 444-001	E1 44484	1F8 007 560-051	E1 53209	2BE 003 014-251
e1 3829	2RL 863 132-021	E1 43207	2SD 001 688-141	E1 44484	1F8 007 560-131	E1 53209	2BE 003 014-257
e1 3829	2RL 863 132-031	E1 43207	2SD 001 688-171	E1 44484	1F8 007 560-331	E1 53210	2ST 003 014-141
E1 390	9EL 963 111-011	E1 43207	2SE 001 688-151	E1 44484	1F8 007 560-401	E1 53210	9EL 115 003-021
E1 390	9EL 963 112-011	E1 43207	2SE 001 688-161	E1 44484	1F8 007 560-411	E1 53211	2SW 003 014-131
E1 391	9EL 962 585-051	E1 43207	9EL 092 435-011	E1 44484	1F8 007 560-421	E1 53211	2SY 003 014-121
E1 391	9EL 962 586-051	E1 43222	9EL 107 368-001	E1 44484	1F8 007 560-451	E1 53211	9EL 115 003-001
E1 392	9EL 907 325-001	E1 43222	9EL 111 647-001	E1 44484	1F8 147 077-011	E1 53211	9EL 115 003-011
E1 392	9EL 907 326-001	E1 43260	9EL 102 240-031	E1 44484	1F8 157 042-011	E1 53221	2SD 002 844-021
E1 4	1LG 006 898-051	E1 43261	2SD 001 686-101	E1 44484	1F8 158 926-011	E1 53221	2SD 002 844-031
E1 4	1LG 006 898-091	E1 43261	2SE 001 686-142	E1 44484	1F8 162 870-011	E1 53221	2SD 002 844-061
E1 40	9EL 143 579-021	E1 43261	9EL 102 240-031	E1 44484	1F8 162 871-011	E1 53221	2SD 002 844-067
E1 40	9EL 143 580-021	E1 43322	2SD 001 680-271	E1 44484	1F8 162 872-011	E1 53221	2SD 002 844-131
E1 4043	2SK 010 133-801	E1 43322	2SD 001 680-281	E1 44484	1F8 162 873-011	E1 53221	2SE 002 844-011
E1 405	2BA 004 119-017	E1 43322	2SD 001 680-391	E1 44484	1F8 162 874-011	E1 53221	2SE 002 844-051
E1 41	1NA 007 039-011	E1 43322	2SD 001 680-401	E1 44484	1F8 165 946-011	E1 53221	9EL 115 662-001
E1 41	1NA 007 039-021	E1 43322	2SE 001 680-291	E1 46	1LH 006 900-031	E1 53221	9EL 115 662-011
E1 42612	9EL 123 323-011	E1 43322	2SE 001 680-301	E1 46	9ES 143 775-011	E1 53221	9EL 115 662-021
E1 42612	9EL 123 324-011	E1 43331	2SD 002 514-161	E1 47	1LH 006 900-041	E1 53234	2SD 001 693-011
E1 42621	2BM 004 563-111	E1 43331	2SE 002 514-171	E1 47	9ES 143 776-011	E1 53248	2VP 003 069-021
E1 42623	2BA 003 734-001	E1 43331	9EL 119 614-031	E1 475	9EL 007 727-801	E1 53250	2SD 003 167-521
E1 42627	2BM 003 933-031	E1 43332	2SD 001 699-061	E1 475	9EL 007 727-811	E1 53250	9EL 118 445-001
E1 42627	2BM 003 933-041	E1 43332	2SD 001 699-511	E1 475	9EL 148 141-021	E1 53253	2SD 003 184-031
E1 42641	2BA 003 734-061	E1 43332	2SE 001 699-071	E1 475	9EL 148 142-021	E1 53253	2SD 003 184-037
E1 42650	2BA 003 975-031	E1 43332	9EL 109 139-001	E1 477	9EL 142 723-011	E1 53253	2SD 003 184-041
E1 42650	2BA 003 975-041	E1 43346	9EL 113 065-001	E1 477	9EL 142 724-011	E1 53253	2SD 003 184-047
E1 42657	2BA 001 423-087	E1 43370	2SE 002 578-701	E1 477	9EL 147 723-071	E1 53253	2SE 003 184-011
E1 42665	2BA 004 257-011	E1 43370	2SE 002 578-707	E1 477	9EL 147 724-071	E1 53253	2SE 003 184-017
E1 42665	2BA 004 257-021	E1 43370	9EL 146 491-001	E1 486	2BA 007 775-051	E1 53253	2SE 003 184-101
E1 42665	9EL 127 688-001	E1 43388	2BE 002 582-031	E1 486	2BA 007 775-061	E1 53253	8RA 123 251-005
E1 42669	2BM 004 312-051	E1 43388	9EL 112 744-001	E1 487	9EL 147 845-021	E1 53253	9EL 118 697-001
E1 42669	2BM 004 312-061	E1 439	2PS 340 000-001	E1 487	9EL 147 846-021	E1 53253	9EL 118 700-001
E1 42669	9EL 127 855-001	E1 439	2PS 340 000-011	E1 488	1FA 007 133-021	E1 53253	9EL 118 701-001
E1 42669	9EL 127 856-001	E1 439	2PS 340 000-021	E1 488	1NA 007 133-001	E1 53253	9EL 121 431-001
E1 42680	2BA 004 119-001	E1 439	2PS 340 000-041	E1 492	1DL 005 600-097	E1 53254	2BE 003 184-051
E1 42691	9EL 129 161-011	E1 439	2PS 340 000-051	E1 492	1DL 005 600-107	E1 53254	2BE 003 184-061
E1 42691	9EL 129 162-011	E1 439	2PS 340 000-171	E1 508	2PS 007 972-011	E1 53254	9EL 118 703-001
E1 42706	9EL 129 614-011	E1 440	1NL 007 594-031	E1 508	2PS 007 972-017	E1 53254	9EL 118 705-001
E1 42706	9EL 129 615-011	E1 440	1NL 007 594-041	E1 513	9EL 151 829-011	E1 53256	2SW 003 185-041
E1 42706	9FT 129 176-001	E1 44404	1F4 005 750-301	E1 513	9EL 151 830-011	E1 53256	2SW 003 185-047
E1 42710	2BM 004 965-801	E1 44404	1F4 005 750-811	E1 515	1L3 002 850-068	E1 53256	9EL 118 633-001
E1 42712	2BE 003 014-251	E1 44404	1F4 135 230-011	E1 515	2SK 008 579-091	E1 53257	2SD 003 182-051
E1 42712	2BE 003 014-257	E1 44405	1F4 005 750-071	E1 515	2SK 008 579-101	E1 53257	2SD 003 182-057
E1 42712	9EL 115 003-055	E1 44405	1F4 005 750-871	E1 515	2SK 008 579-111	E1 53257	2SD 003 182-061
E1 42743	2BA 005 407-001	E1 44408	1FE 005 478-011	E1 515	2SK 008 579-121	E1 53257	2SD 003 182-067
E1 42745	2BA 005 481-001	E1 44408	1FE 005 478-021	E1 515	2SK 008 579-131	E1 53257	2SE 003 182-011
E1 42745	2BA 005 481-011	E1 44410	1FD 003 590-411	E1 515	2SK 008 579-141	E1 53257	2SE 003 182-017
E1 42748	2BA 005 603-001	E1 44410	1FD 005 700-051	E1 515	2SK 008 579-151	E1 53257	2SE 003 182-021
E1 42748	2BA 005 603-007	E1 44410	1FD 005 700-301	E1 515	2SK 008 579-161	E1 53257	2SE 003 182-027
E1 42749	2BA 005 603-011	E1 44410	1FD 005 700-851	E1 52253	8RA 123 251-005	E1 53257	9EL 118 613-001
E1 42749	2BA 005 603-017	E1 44410	1FD 135 198-011	E1 52604	9EL 139 383-031	E1 53257	9EL 118 614-011
E1 42749	2BA 005 603-217	E1 44439	1LB 006 213-047	E1 52604	9EL 139 384-031	E1 53259	2BE 003 185-031
E1 42750	9EL 135 007-001	E1 44439	1LB 006 213-057	E1 52609	2BA 004 693-031	E1 53259	9EL 119 397-001
E1 42750	9EL 135 008-001	E1 44439	1LB 007 145-047	E1 52609	2BA 004 693-041	E1 53270	2BE 003 182-091
E1 42756	9EL 133 713-011	E1 44442	1FB 005 860-031	E1 52609	2BA 004 693-801	E1 53270	2BE 003 182-101
E1 42756	9EL 133 714-011	E1 44442	1FB 005 860-061	E1 52609	9EL 129 614-021	E1 53270	9EL 118 614-021
E1 42763	2BA 002 652-101	E1 44442	1FB 005 860-831	E1 52609	9EL 129 615-021	E1 53274	2BE 003 347-001
E1 42763	2BA 002 652-107	E1 44442	1FB 137 006-021	E1 52610	2BA 005 296-031	E1 53274	9EL 120 224-001
E1 42763	9EL 134 658-001	E1 44444	1FE 006 300-001	E1 52610	2BA 005 296-041	E1 53275	9EL 119 097-021
E1 42764	2BA 002 652-111	E1 44444	1FE 006 300-041	E1 52611	2BA 004 257-031	E1 53275	9EL 119 098-021
E1 42764	2BA 002 652-117	E1 44444	1FE 006 300-251	E1 52611	2BA 004 257-041	E1 53276	9EL 119 874-001
E1 42764	2BA 002 652-121	E1 44444	1FE 006 300-261	E1 52617	2BA 006 386-071	E1 53288	2SD 003 409-181
E1 42764	2BA 002 652-127	E1 44444	1FE 138 520-011	E1 52617	2BA 006 386-081	E1 53288	2SD 003 409-201
E1 42764	9EL 134 659-001	E1 44444	1FE 158 877-011	E1 52618	2BA 007 177-011	E1 53288	2SD 003 409-207
E1 42764	9EL 134 660-001	E1 44445	1FE 006 300-081	E1 52618	2BA 007 177-021	E1 53288	2SD 003 409-317
E1 42766	2BA 007 275-011	E1 44445	1FE 006 300-191	E1 52618	2BA 007 177-801	E1 53288	2SD 003 409-327
E1 42766	2BA 007 275-021	E1 44468	1LJ 006 360-671	E1 52621	2BM 006 692-011	E1 53288	2SE 003 409-171
E1 42767	9EL 133 719-011	E1 44468	1LL 009 213-031	E1 52621	2BM 006 692-017	E1 53288	2SE 003 409-191
E1 42767	9EL 133 720-011	E1 44469	1LJ 006 360-681	E1 52621	2BM 006 692-021	E1 53288	2SE 003 409-197
E1 42770	2BA 005 200-311	E1 44469	1LL 009 213-041	E1 52621	2BM 006 692-027	E1 53288	9EL 121 260-051
E1 42781	2BM 002 652-031	E1 44478	9ES 145 599-001	E1 52627	9EL 141 605-011	E1 53288	9EL 121 260-061
E1 42787	9EL 136 401-011	E1 44478	9ES 145 600-001	E1 52627	9EL 141 606-011	E1 53300	9EL 122 149-011
E1 42787	9EL 136 402-011	E1 44484	1F8 006 800-191	E1 52636	9EL 147 073-001	E1 53300	9EL 122 150-011
E1 42788	2BA 002 939-171	E1 44484	1F8 006 800-221	E1 52637	9EL 150 987-001	E1 53312	2BE 003 649-011
E1 42788	2BA 002 939-251	E1 44484	1F8 006 800-331	E1 52637	9EL 150 988-001	E1 53312	2BE 003 649-021
E1 42788	9EL 116 771-031	E1 44484	1F8 006 800-341	E1 52638	9EL 150 867-001	E1 53312	9EL 123 209-005
E1 42795	9EL 962 025-031	E1 44484	1F8 006 800-351	E1 52638	9EL 150 868-001	E1 53312	9EL 123 210-005
E1 42795	9EL 962 026-031	E1 44484	1F8 006 800-361	E1 53	1LG 006 920-231	E1 53335	2SD 001 680-271
E1 42796	9EL 144 443-001	E1 44484	1F8 007 560-041	E1 53	1LG 006 920-241	E1 53335	2SD 001 680-281

Type Approval Numbers



E1 53335	2SD 001 680-391	E1 63215	2VA 005 553-121	E1 63296	9EL 142 825-031	E1 7128	9ES 118 403-001
E1 53335	2SD 001 680-401	E1 63215	2VA 005 553-131	E1 63296	9EL 142 826-021	E1 7129	1LH 002 658-521
E1 53335	2SE 001 680-291	E1 63215	2VA 005 553-141	E1 63296	9EL 142 826-031	E1 713	9ES 118 402-001
E1 53335	2SE 001 680-301	E1 63217	2VD 005 300-551	E1 63298	9EL 142 825-021	E1 714	1LJ 007 833-121
E1 53335	9EL 107 368-001	E1 63217	2VD 005 300-581	E1 63298	9EL 142 825-031	E1 714	1LJ 007 833-111
E1 53335	9EL 111 647-001	E1 63217	2VD 007 500-091	E1 63298	9EL 142 826-021	E1 7144	1L8 003 060-691
E1 53342	9EL 125 910-041	E1 63217	2VD 007 500-111	E1 63298	9EL 142 826-031	E1 7144	1L8 004 148-017
E1 53344	9EL 126 339-021	E1 63217	2VD 007 500-201	E1 633	1LG 007 861-451	E1 7144	1L8 004 190-111
E1 53344	9EL 126 340-021	E1 63217	2VD 007 500-221	E1 63301	9EL 141 889-041	E1 7144	1L8 139 474-015
E1 53345	2SE 002 582-071	E1 63217	2VD 007 500-411	E1 63301	9EL 141 890-041	E1 715	1LJ 007 833-121
E1 53345	9EL 112 741-001	E1 63217	2VP 007 500-421	E1 634	1LG 007 861-461	E1 7165	9ES 120 723-001
E1 53345	9EL 112 743-001	E1 63217	9EL 134 296-041	E1 645	1N4 007 893-001	E1 7197	1LB 003 177-081
E1 53345	9EL 116 844-001	E1 63217	9EL 134 296-051	E1 645	1N4 007 893-821	E1 7197	1LB 003 177-511
E1 53367	9EL 129 149-021	E1 63217	9EL 134 301-001	E1 645	1N4 149 531-011	E1 7197	1LB 006 277-137
E1 53367	9EL 129 150-021	E1 63217	9EL 134 301-011	E1 646	1FA 007 893-021	E1 7197	1VB 005 444-037
E1 53378	2VP 004 686-111	E1 63225	2BE 002 776-251	E1 646	1FA 007 893-081	E1 7402	1VB 005 444-037
E1 53378	2VP 004 686-121	E1 63225	2BE 002 776-257	E1 646	1FA 007 893-141	E1 7407	1DL 005 930-371
E1 53378	2VP 004 686-141	E1 63225	2BE 002 776-261	E1 646	1FA 007 893-191	E1 7407	1DL 005 930-381
E1 53378	2VP 004 686-151	E1 63225	2BE 002 776-267	E1 646	1FA 007 893-811	E1 7411	1DL 005 600-097
E1 53378	2VP 004 686-181	E1 63225	9EL 134 741-021	E1 646	1FA 007 893-841	E1 7411	1DL 005 600-107
E1 53378	9EL 129 762-001	E1 63225	9EL 134 742-021	E1 646	1FA 007 893-871	E1 7411	1DL 007 872-017
E1 53378	9EL 129 762-031	E1 63230	2SD 002 776-231	E1 646	1FA 149 537-011	E1 7411	1DL 007 872-027
E1 53378	9EL 129 763-001	E1 63230	2SD 002 776-237	E1 646	1FA 157 022-011	E1 7411	1DL 007 872-037
E1 53378	9EL 129 763-021	E1 63230	2SD 002 776-241	E1 646	1FA 160 300-011	E1 7411	1DL 007 872-047
E1 53384	2VA 004 887-031	E1 63230	2SD 002 776-247	E1 647	1FA 007 893-201	E1 7411	1DL 007 872-077
E1 53384	2VB 004 887-011	E1 63230	2SE 002 776-211	E1 647	1FA 007 893-241	E1 7411	1DL 007 872-087
E1 53384	2VP 004 887-021	E1 63230	2SE 002 776-217	E1 647	1FA 007 893-911	E1 7515	2DA 959 380-111
E1 53384	9EL 131 420-001	E1 63230	2SE 002 776-221	E1 647	1FA 007 893-921	E1 7515	2DA 959 380-511
E1 53384	9EL 131 420-011	E1 63230	9EL 134 739-001	E1 647	1FA 160 302-011	E1 76	1NA 962 490-011
E1 53399	9EL 131 651-031	E1 63230	9EL 134 740-001	E1 647	1FA 162 883-011	E1 76	1NA 962 490-021
E1 53399	9EL 131 652-031	E1 63230	9EL 137 307-001	E1 648	1NB 007 892-001	E1 77	1NA 962 530-011
E1 536	2BE 004 119-021	E1 63230	9EL 137 308-001	E1 648	1NB 007 892-041	E1 77	1NA 962 530-021
E1 548	1NL 007 834-017	E1 63243	2VP 004 686-151	E1 648	1NB 007 892-821	E1 774	2RL 863 132-001
E1 548	1NL 007 834-057	E1 63243	2VP 004 686-181	E1 649	1FB 007 892-011	E1 799	2DA 008 136-007
E1 549	1KL 007 834-027	E1 63243	9EL 129 762-031	E1 649	1FB 007 892-071	E1 799	2DA 008 136-017
E1 549	1KL 007 834-067	E1 63243	9EL 129 763-021	E1 649	1FB 007 892-131	E1 799	2DA 008 136-027
E1 549	1KL 007 834-097	E1 63250	9EL 146 371-001	E1 649	1FB 007 892-811	E1 799	2DA 008 136-031
E1 55	1LG 006 920-231	E1 63250	9EL 146 372-001	E1 649	1FB 007 892-841	E1 80	1LJ 007 143-051
E1 550	1BL 007 834-001	E1 63251	9EL 962 025-011	E1 649	1FB 149 519-011	E1 80	9ES 145 251-005
E1 550	1BL 007 834-037	E1 63251	9EL 962 025-031	E1 649	1FB 162 881-011	E1 801	9EL 146 838-001
E1 550	1BL 007 834-047	E1 63251	9EL 962 026-031	E1 65	2DA 005 739-111	E1 805	9EL 964 005-021
E1 550	1BL 007 834-132	E1 63251	9EL 962 027-011	E1 65	2DA 005 739-117	E1 805	9EL 964 006-021
E1 556	1F8 007 560-561	E1 63251	9EL 962 028-011	E1 650	1NA 007 891-041	E1 808	2VP 008 101-031
E1 556	1F8 007 560-571	E1 63253	2BA 003 236-541	E1 650	1NA 007 891-821	E1 808	2VP 008 101-041
E1 556	1F8 149 644-011	E1 63256	9EL 138 567-031	E1 651	1FA 007 891-061	E1 81	1LJ 007 143-061
E1 56	1LG 006 920-241	E1 63256	9EL 138 567-061	E1 651	1FA 007 891-811	E1 81	9ES 145 252-005
E1 567	2VP 007 240-091	E1 63256	9EL 138 568-031	E1 651	1FA 007 891-841	E1 817	2RL 007 900-001
E1 567	2VP 007 240-101	E1 63256	9EL 138 568-061	E1 651	1FA 149 504-011	E1 817	2RL 007 900-151
E1 584	2PF 003 563-151	E1 63256	9EL 140 063-021	E1 6517	2RL 007 900-121	E1 817	2RL 007 900-171
E1 584	2PF 003 563-177	E1 63256	9EL 140 064-021	E1 6517	2RL 007 900-221	E1 817	2RL 007 900-191
E1 584	2PF 003 563-187	E1 63257	9EL 137 819-031	E1 6517	2RL 007 900-241	E1 817	2RL 007 900-201
E1 586	2BA 005 603-117	E1 63257	9EM 137 820-021	E1 6517	2RL 007 900-631	E1 817	2RL 007 900-211
E1 590	1LL 007 821-291	E1 63264	9EL 139 137-051	E1 672	1LL 007 950-251	E1 817	2RL 007 900-251
E1 590	1LL 007 821-301	E1 63264	9EL 139 137-061	E1 672	1LL 007 950-261	E1 817	2RL 007 900-291
E1 591	1LL 007 821-291	E1 63264	9EL 139 138-051	E1 672	1LL 009 020-231	E1 817	2RL 007 900-501
E1 591	1LL 007 821-301	E1 63264	9EL 139 138-061	E1 672	1LL 009 020-241	E1 817	2RL 007 900-511
E1 597	2KA 007 929-001	E1 63266	9EL 138 567-061	E1 673	1LL 007 950-251	E1 817	2RL 007 900-521
E1 597	2KA 007 929-007	E1 63266	9EL 138 568-061	E1 673	1LL 007 950-261	E1 817	2RL 007 900-551
E1 601	1LL 007 950-251	E1 63269	9EL 140 347-021	E1 673	1LL 009 020-231	E1 817	2RL 007 900-561
E1 601	1LL 007 950-261	E1 63269	9EL 140 348-021	E1 673	1LL 009 020-241	E1 817	2RL 007 900-601
E1 602	1LL 007 950-251	E1 63278	9EL 006 220-921	E1 681	2SB 001 423-097	E1 817	2RL 007 900-611
E1 602	1LL 007 950-261	E1 63278	9EL 139 137-071	E1 683	9EL 963 701-011	E1 817	2RL 007 900-681
E1 615	1LG 007 640-331	E1 63278	9EL 139 137-081	E1 683	9EL 963 702-011	E1 817	2RL 863 132-001
E1 615	1LG 007 640-631	E1 63278	9EL 139 138-071	E1 684	9EL 964 599-001	E1 8336	1ND 122 390-001
E1 616	1LG 007 640-341	E1 63278	9EL 139 138-081	E1 685	9EL 964 599-001	E1 8345	1NB 003 367-137
E1 616	1LG 007 640-641	E1 63290	2VP 004 686-151	E1 7004	9ES 084 374-001	E1 8358	1NB 123 581-001
E1 617	1LG 007 640-331	E1 63290	2VP 004 686-181	E1 7016	1LG 003 434-187	E1 8359	1NB 123 582-001
E1 617	1LG 007 640-631	E1 63290	9EL 129 762-031	E1 7016	9ES 122 221-007	E1 8371	1NB 004 691-147
E1 618	1LG 007 640-341	E1 63290	9EL 129 763-021	E1 7035	9ES 091 489-001	E1 838	1NA 963 965-051
E1 618	1LG 007 640-641	E1 63294	9EL 141 889-031	E1 704	2BA 007 924-071	E1 838	1NA 963 965-061
E1 62	9ES 145 599-001	E1 63294	9EL 141 889-041	E1 704	2BA 007 924-081	E1 839	1NA 007 976-071
E1 62	9ES 145 600-001	E1 63294	9EL 141 890-031	E1 706	1M3 114 178-001	E1 839	1NA 007 976-081
E1 630	9EL 148 179-021	E1 63294	9EL 141 890-041	E1 7097	1L8 003 060-561	E1 839	1NA 007 976-231
E1 630	9EL 148 179-031	E1 63295	9EL 006 220-851	E1 7108	1LH 002 658-451	E1 839	1NA 007 976-241
E1 630	9EL 148 180-021	E1 63295	9EL 006 220-921	E1 7108	9ES 113 919-001	E1 8438	2NE 005 603-071
E1 630	9EL 148 180-031	E1 63295	9EL 006 220-931	E1 7109	1LH 002 658-461	E1 8438	2NE 005 603-077
E1 631	1LG 007 861-451	E1 63295	9EL 139 137-091	E1 7109	9ES 113 918-001	E1 8444	2NE 002 589-001
E1 632	1LG 007 861-461	E1 63295	9EL 139 138-091	E1 712	1LJ 007 833-111	E1 8444	2NE 002 589-047
E1 63215	2VA 005 553-111	E1 63296	9EL 142 825-021	E1 7128	1LH 002 658-511	E1 8444	9EL 112 763-001



Type Approval Numbers

E1 845	1LF 963 709-071	E1 901	1NA 963 981-031	E12 4033	2KA 997 011-021	E12 7111	9EL 998 001-031
E1 845	1LF 963 709-081	E1 901	1NA 963 981-041	E12 4035	2SE 997 088-001	E12 7111	9EL 998 001-041
E1 8465	2NE 002 985-001	E1 915	9EL 964 023-011	E12 4038	2SE 997 111-011	E12 7113	2BE 997 131-081
E1 8465	9EL 117 094-001	E1 915	9EL 964 024-011	E12 4038	2SE 997 111-021	E12 7113	2BE 997 131-207
E1 8466	2NE 002 985-001	E1 917	1K0 008 191-001	E12 4038	9EL 997 451-001	E12 7113	9EL 997 459-001
E1 8466	9EL 117 094-001	E1 917	1K0 008 191-007	E12 4038	9EL 997 452-001	E12 7114	2BE 997 131-207
E1 847	1LF 963 709-071	E1 917	1K0 008 191-011	E12 4043	2KA 997 122-001	E12 7114	2SD 997 131-051
E1 848	1LF 963 709-081	E1 917	1K0 008 191-017	E12 4054	2SD 996 030-021	E12 7114	9EL 997 469-001
E1 8486	2NE 003 315-011	E1 917	1K0 008 191-021	E12 4054	2SE 996 030-011	E12 7133	2SD 996 030-021
E1 8486	9EL 119 977-001	E1 917	1K0 008 191-027	E12 4054	9EL 990 142-001	E12 7133	2SE 996 030-011
E1 8496	2NE 001 423-011	E1 917	1K0 008 191-041	E12 6007	2SD 997 005-021	E12 7133	9EL 990 142-001
E1 8496	9EL 101 353-001	E1 917	1K0 008 191-047	E12 6007	2SE 997 005-011	E12 7136	2SD 001 685-307
E1 86	2PS 006 717-031	E1 917	1K0 008 191-212	E12 6007	9EL 997 313-001	E12 7136	9EL 151 494-001
E1 86	2PS 006 717-032	E1 917	1K0 008 191-227	E12 6040	2SD 997 006-021	E12 7146	2SD 001 685-211
E1 86	2PS 006 717-037	E1 917	1K0 008 192-001	E12 6040	2SD 997 006-031	E12 7146	2SD 001 685-218
E1 86	2PS 006 717-051	E1 917	1K0 008 192-007	E12 6040	2SE 997 006-011	E12 7146	2SD 001 685-231
E1 86	2PS 006 717-057	E1 917	1K0 008 192-011	E12 6040	9EL 997 315-001	E12 7146	2SD 001 685-232
E1 86	2PS 006 717-061	E1 917	1K0 008 192-017	E12 6041	2BA 996 012-061	E12 7146	2SD 001 685-277
E1 86	2PS 006 717-067	E1 917	1K0 008 192-027	E12 6041	2BA 996 012-071	E12 7146	2SD 001 685-317
E1 86	2PS 006 717-071	E1 917	1K0 158 059-061	E12 6041	2BA 996 012-147	E12 7146	2SE 001 685-201
E1 86	9EL 141 135-031	E1 917	1K0 158 059-071	E12 6041	9EL 990 034-041	E12 7146	2SE 001 685-221
E1 8703	2ZR 003 014-091	E1 917	1LL 008 193-117	E12 6044	2BA 997 027-031	E12 7146	2SE 001 685-227
E1 8704	2ZR 001 423-001	E1 917	1LL 008 193-127	E12 6046	2SD 998 531-057	E12 7146	9EL 113 324-001
E1 8704	9ES 106 588-001	E1 917	1LL 008 194-017	E12 6046	2SD 998 531-067	E12 7154	2DA 996 012-041
E1 8708	2ZR 002 694-001	E1 917	1LL 008 194-051	E12 6060	2BA 996 027-001	E12 7176	2SD 001 685-307
E1 8708	2ZR 002 694-002	E1 917	1LL 158 060-031	E12 6060	9EL 990 068-001	E12 7176	9EL 151 494-001
E1 8708	9EL 113 928-001	E1 925	1LH 008 010-031	E12 6069	2BA 007 840-001	E12989	2RL 010 743-061
E1 8709	2ZR 001 193-011	E1 926	1LH 008 010-041	E12 6070	2BE 996 029-021	E13 0515	2XS 008 078-001
E1 8712	2ZR 002 985-081	E1 93	1LF 962 489-151	E12 6072	2SE 997 111-011	E13 0515	2XS 008 078-007
E1 8712	2ZR 002 985-261	E1 93	1LF 962 489-171	E12 6072	2SE 997 111-021	E13 0515	2XS 008 078-011
E1 8725	2ZR 002 589-011	E1 94	1LF 962 489-161	E12 6072	9EL 997 451-001	E13 12458	1LL 010 146-031
E1 8725	9EL 112 858-011	E1 94	1LF 962 489-181	E12 6072	9EL 997 452-001	E13 12458	1LL 010 146-041
E1 8726	2ZR 003 030-171	E1 962	9EL 152 051-011	E12 6077	2VA 997 113-001	E13 12459	1LL 010 146-031
E1 8726	9EL 122 268-001	E1 962	9EL 152 052-011	E12 6077	9EL 997 453-001	E13 12459	1LL 010 146-041
E1 8728	2JA 001 357-002	E1 97	9EL 962 541-041	E12 6081	2VA 998 531-031	E13 1299	2BM 006 759-001
E1 8728	2ZR 003 236-051	E1 97	9EL 962 542-051	E12 6081	9EL 997 310-001	E13 141	1NB 007 555-031
E1 8728	2ZR 003 236-057	E1 989	2BA 008 260-001	E12 6081	9EL 998 001-031	E13 141	1NB 007 555-041
E1 8728	2ZR 003 236-311	E1 989	2BA 008 260-007	E12 6081	9EL 998 001-041	E13 193	2BA 008 404-011
E1 8728	2ZR 004 432-001	E1 989	2BA 008 260-017	E12 6085	2BE 997 131-081	E13 194	2BA 008 404-021
E1 8728	9EL 119 544-111	E1 999	1F5 008 273-041	E12 6085	2BE 997 131-207	E13 2J6	8GH 007 643-121
E1 8731	2ZR 003 734-041	E1 999	1F5 154 875-011	E12 6085	9EL 997 459-001	E13 305	1ND 007 646-011
E1 8731	9EL 123 635-001	E12 112018	1LL 354 687-031	E12 6085	2BE 997 131-207	E13 305	1ND 007 646-021
E1 8732	2ZR 003 315-041	E12 112018	1LL 354 687-041	E12 6089	2SD 997 131-051	E13 3534	9EL 246 201-011
e1 8740	2ZR 996 012-111	E12 112018	1ZS 354 688-031	E12 6089	9EL 997 469-001	E13 3534	9EL 246 202-011
E1 8743	2ZR 004 542-001	E12 112018	1ZS 354 688-041	E12 6100	9EL 146 021-001	E13 3535	8RA 002 014-081
E1 8750	2ZR 001 421-101	E12 16066	2SE 997 088-001	E12 6101	2BA 007 839-001	E13 3535	8RA 002 014-091
E1 8760	9EL 131 613-031	E12 19094	1NA 009 026-011	E12 7010	2SD 997 005-021	E13 3535	8RA 002 014-101
E1 8760	9EL 131 614-031	E12 19094	1NA 009 026-021	E12 7010	2SE 997 005-011	E13 3561	2BA 007 016-031
E1 8760	9EM 131 613-021	E12 19096	1NA 009 029-011	E12 7010	9EL 997 313-001	E13 3561	2BA 007 016-041
E1 8760	9EM 131 614-021	E12 19096	1NA 009 029-021	E12 7039	2PF 997 022-011	E13 4719	9EL 962 542-071
E1 8761	2NR 005 190-071	E12 19098	1NA 009 033-011	E12 7039	2PF 997 023-011	E13 550	9EL 156 099-801
E1 8769	2NR 005 554-111	E12 19098	1NA 009 033-021	E12 7039	2SA 997 022-001	E13 9219	1LE 007 350-111
E1 8769	2NR 005 554-121	E12 19105	1NA 009 031-011	E12 7039	2SA 997 023-001	E13 9220	1LE 007 350-121
E1 877	1NL 008 090-031	E12 19105	1NA 009 031-021	E12 7048	2PF 997 027-011	E13 9222	1LL 007 510-071
E1 877	1NL 008 090-037	E12 19111	1NL 009 034-011	E12 7048	2SA 997 027-001	E13 9222	1LL 007 510-081
E1 877	1NL 008 090-117	E12 19111	1NL 009 034-021	E12 7048	9EL 997 387-001	E13 9385	2SD 006 040-031
E1 877	1NL 008 090-301	E12 20005	1L3 996 002-411	E12 7048	9EL 997 388-001	E13 9385	2SD 006 040-037
E1 877	1NL 008 090-317	E12 20005	1L3 996 026-041	E12 7049	2PF 996 112-031	E13 9385	2SD 006 040-041
E1 877	1NL 008 090-821	E12 23003	2JB 996 012-121	E12 7058	2SD 997 006-021	E13 9385	2SD 006 040-131
E1 877	1NL 008 383-821	E12 23003	2ZR 996 012-101	E12 7058	2SD 997 006-031	E13 9385	2SD 006 040-137
E1 877	1NL 008 383-911	E12 23003	2ZR 996 012-111	E12 7058	2SE 997 006-011	E13 9385	2SD 006 040-141
E1 8770	2ZR 005 603-061	E12 23003	9EL 990 122-001	E12 7058	9EL 997 315-001	E13 9385	2SD 006 040-147
E1 8770	2ZR 005 603-067	E12 23005	2ZR 997 506-391	E12 7061	2DA 997 027-021	E13 9385	2SD 006 040-161
E1 8772	2ZR 005 200-301	E12 27092	2SE 997 088-001	E12 7064	2SD 998 531-057	E13 9385	2SD 006 040-167
E1 8772	9EL 135 717-001	E12 3021	2VA 997 113-001	E12 7064	2SD 998 531-067	E13 9385	2SD 006 040-331
E1 878	2BA 008 221-001	E12 3021	9EL 997 453-001	E12 7075	2SA 996 012-091	E13 9385	2SD 006 040-337
E1 878	2BA 008 221-007	E12 3024	2VA 998 531-031	E12 7075	9EL 990 034-051	E13 9385	2SE 006 040-011
E1 878	2BA 008 221-107	E12 3024	9EL 997 310-001	E12 7093	2PF 996 012-051	E13 9385	2VA 006 040-071
E1 8787	9EL 138 463-031	E12 3024	9EL 998 001-031	E12 7095	2BE 996 029-021	E13 9385	2VA 006 040-077
E1 8787	9EL 138 464-031	E12 3024	9EL 998 001-041	E12 7098	2SE 997 111-011	E13 9385	2VA 006 040-291
E1 879	2PF 008 221-011	E12 38007	2NE 996 012-021	E12 7098	2SE 997 111-021	E13 9385	2VA 006 040-297
E1 879	2PF 008 221-017	E12 4003	2SE 997 005-011	E12 7098	9EL 997 451-001	E13 9385	2VA 006 040-457
E1 879	2PF 008 221-177	E12 4003	9EL 997 313-001	E12 7098	9EL 997 452-001	E13 9385	2VB 006 040-051
E1 8796	9EL 141 907-071	E12 4004	2KA 997 011-001	E12 7103	2VA 997 113-001	E13 9385	2VP 006 040-111
E1 8796	9EL 141 908-071	E12 4004	2KA 997 011-011	E12 7103	9EL 997 453-001	E13 9385	2VP 006 040-117
E1 880	1FE 002 537-481	E12 4023	9EL 997 315-001	E12 7106	2XS 005 639-001	E13 9385	2VP 006 040-121
E1 880	1FE 152 896-011	E12 4031	2KA 998 523-001	E12 7106	2XS 005 639-002	E13 9385	2VP 006 040-127
E1 898	9EL 964 055-011	E12 4031	2KA 998 523-007	E12 7111	2VA 998 531-031	E13 9385	2VP 006 040-301
E1 898	9EL 964 056-011	E12 4031	2KA 998 523-117	E12 7111	9EL 997 310-001	E13 9385	2VP 006 040-307

Type Approval Numbers



E13 9385	2VP 006 040-351	E17 0202	2PS 964 295-347	E17 378	2PS 006 717-032	E17 812	2XS 964 295-031
E13 9385	2VP 006 040-357	E17 0202	2PS 964 295-357	E17 378	2PS 006 717-037	E17 812	2XS 964 295-037
E13 9385	2VP 006 040-397	E17 02379	8RA 002 023-001	E17 378	2PS 006 717-051	E17 814	2SB 964 169-301
E13 9385	2VP 006 040-407	E17 02379	8RA 002 023-011	E17 378	2PS 006 717-057	E17 814	2SB 964 169-307
E13 9385	2VP 006 040-437	E17 02379	8RA 002 023-021	E17 378	2PS 006 717-061	E17 817	2PF 964 295-257
E13 9385	2VP 006 040-447	E17 0301	2PG 964 295-111	E17 378	2PS 006 717-067	E17 8902	2SD 006 459-021
E13 9385	2VP 006 040-467	E17 0301	2PG 964 295-117	E17 378	2PS 006 717-071	E17 8902	2SD 006 459-027
E13 9385	2VP 006 040-477	E17 0301	2PG 964 295-121	E17 378	2TM 006 717-047	E17 8902	2SD 006 459-031
E13 9385	2VP 006 040-487	E17 0301	2PG 964 295-127	E17 378	9EL 141 135-021	E17 8902	2SK 006 459-041
E13 9385	9EL 136 819-011	E17 0302	2TM 964 295-091	E17 378	9EL 141 135-031	E17 8904	2SD 006 459-021
E13 9385	9EL 136 819-031	E17 0302	2TM 964 295-097	E17 3806	2NE 006 609-001	E17 8904	2SD 006 459-027
E13 9385	9EL 136 819-041	E17 0302	2TM 964 295-101	E17 3806	2NE 006 609-007	E17 8904	2SD 006 459-031
E13 9385	9EL 136 825-001	E17 0302	2TM 964 295-107	E17 3806	2NE 006 609-011	E17 8904	2SK 006 459-041
E13 9385	9EL 136 825-011	E17 0303	2VA 343 640-067	E17 3806	2NE 006 609-017	E17 8906	2SD 006 459-021
E13 9385	9EL 136 833-001	E17 0303	2VA 343 640-071	E17 3806	2NE 006 609-187	E17 8906	2SD 006 459-027
E13 9385	9EL 136 833-011	E17 0303	2VA 343 640-077	E17 3806	9EL 141 612-001	E17 8906	2SD 006 459-031
E13 9385	9EL 137 792-011	E17 0303	2VA 343 640-101	E17 3808	2NE 964 169-021	E17 8906	2SK 006 459-041
E13 9385	9EL 137 792-031	E17 0303	2VA 343 640-107	E17 3808	2NE 964 169-027	E17 9101	2SB 004 460-061
E13 9401	2XS 950 071-031	E17 0303	2VA 343 640-117	E17 3808	2NE 964 169-227	E17 9301	2SD 004 460-001
E13 9401	2XS 950 031-001	E17 0303	2VA 343 640-131	E17 3809	2NE 964 169-521	E17 9301	2SD 004 460-007
E13 9401	2XS 955 232-001	E17 0303	2VA 343 640-137	E17 3809	2NE 964 169-527	E17 9301	2SD 004 460-011
E13 9401	2XS 955 232-017	E17 0303	2VA 343 640-207	E17 3810	2NE 964 169-341	E17 9301	2SD 004 460-017
E13 9401	9EL 950 315-031	E17 0303	2VA 343 640-237	E17 3810	2NE 964 169-667	E17 9303	2SK 004 460-031
E13 9401	9EL 950 315-061	E17 0303	2VB 343 640-011	E17 402	8RA 342 014-157	E17 9303	2SK 004 460-037
E13 9428	2XS 955 260-001	E17 0303	2VB 343 640-017	E17 408	2SE 004 623-001	E17 9303	2SK 004 460-041
E13 9428	2XS 955 260-007	E17 0303	2VB 343 640-127	E17 408	2SE 004 623-007	E17 9401	2SE 002 578-701
E13 9428	9EL 964 289-001	E17 0303	2VB 343 640-297	E17 408	2XL 004 762-001	E17 9401	2SE 002 578-707
E13 9438	9EL 964 116-121	E17 0303	2VP 343 640-021	E17 408	9EL 129 519-001	E17 9401	9EL 146 491-001
E13 9492	9EL 007 720-851	E17 0303	2VP 343 640-027	E17 418	2VB 341 032-111	E17 9402	2SK 006 459-041
E13 9492	9EL 148 179-131	E17 0303	2VP 343 640-031	E17 418	2VB 341 032-117	E17 9602	9EL 341 325-311
E13 9492	9EL 148 180-131	E17 0303	2VP 343 640-041	E17 418	2VB 341 032-121	E17 9602	9EL 341 325-321
E13 9493	9EL 007 720-821	E17 0303	2VP 343 640-047	E17 418	2VB 341 032-127	E17 9603	9EL 341 326-311
E13 9493	9EL 007 720-831	E17 0303	2VP 343 640-051	E17 418	2VB 341 032-141	E17 9603	9EL 341 326-321
E13 9493	9EL 007 720-871	E17 0303	2VP 343 640-057	E17 630	2SD 004 623-028	E17 9604	2VA 007 502-011
E13 9493	9EL 148 179-101	E17 0303	2VP 343 640-081	E17 630	2SE 004 623-001	E17 9604	2VA 007 502-017
E13 9493	9EL 148 180-101	E17 0303	2VP 343 640-087	E17 630	2SE 004 623-007	E17 9604	2VA 007 502-021
E13 9531	2VA 006 040-071	E17 0303	2VP 343 640-091	E17 630	2XL 004 762-001	E17 9604	2VA 007 502-027
E13 9531	2VA 006 040-077	E17 0303	2VP 343 640-097	E17 630	9EL 129 519-001	E17 9604	2VA 007 502-061
E13 9531	2VA 006 040-291	E17 0303	2VP 343 640-247	E17 648	2BA 964 169-011	E17 9604	2VA 007 502-067
E13 9531	2VA 006 040-297	E17 0303	2VP 343 640-257	E17 648	2BA 964 169-017	E17 9604	2VA 007 502-111
E13 9531	2VA 006 040-457	E17 0303	2VP 343 640-267	E17 648	2BA 964 169-647	E17 9604	2VA 007 502-117
E13 9531	2VB 006 040-051	E17 0303	2VP 343 640-277	E17 648	9EL 964 527-001	E17 9604	2VP 007 502-031
E13 9531	2VP 006 040-111	E17 0303	9EL 343 142-001	E17 651	2BM 964 295-041	E17 9604	2VP 007 502-037
E13 9531	2VP 006 040-117	E17 0303	9EL 343 143-001	E17 651	2BM 964 295-047	E17 9604	2VP 007 502-041
E13 9531	2VP 006 040-121	E17 0303	9EL 343 143-011	E17 652	2BA 964 169-311	E17 9604	2VP 007 502-047
E13 9531	2VP 006 040-127	E17 0501	2SD 343 440-017	E17 653	2BA 964 169-501	E17 9604	2VP 007 502-121
E13 9531	2VP 006 040-301	E17 0501	2SD 343 440-047	E17 653	2BA 964 169-507	E17 9604	2VP 007 502-127
E13 9531	2VP 006 040-307	E17 0501	2SK 343 440-027	E17 763	2SD 004 623-028	E17 9605	2PS 340 001-001
E13 9531	2VP 006 040-351	E17 0501	2SK 343 440-037	E17 763	2SE 004 623-001	E17 9605	2PS 340 001-011
E13 9531	2VP 006 040-357	E17 2309	2ZR 006 609-081	E17 763	2SE 004 623-007	E17 9605	2PS 963 639-001
E13 9531	2VP 006 040-397	E17 2309	2ZR 006 609-087	E17 763	2XL 004 762-001	E17 9605	2PS 963 639-007
E13 9531	2VP 006 040-407	E17 2309	2ZR 006 609-171	E17 763	9EL 129 519-001	E17 9605	2PS 963 639-011
E13 9531	2VP 006 040-437	E17 2311	2ZR 964 169-031	E17 787	2TM 006 717-047	E17 9605	2PS 963 639-017
E13 9531	2VP 006 040-447	E17 2311	2ZR 964 169-037	E17 789	2PG 006 717-021	E17 9605	2PS 963 639-021
E13 9531	2VP 006 040-467	E17 2311	2ZR 964 169-107	E17 789	2PG 006 717-022	E17 9605	2PS 963 639-027
E13 9531	2VP 006 040-477	E17 2311	2ZR 964 169-657	E17 789	2PG 006 717-027	E17 9605	2PS 963 639-031
E13 9531	2VP 006 040-487	E17 2311	2ZR 964 169-737	E17 789	9EL 141 135-021	E17 9605	2PS 963 639-037
E13 9531	9EL 136 819-031	E17 2311	9EL 964 529-001	E17 795	2DA 007 428-001	E17 9605	2PS 963 639-041
E13 9531	9EL 136 825-001	E17 2312	2ZR 964 169-511	E17 795	2DA 007 428-007	E17 9605	2PS 963 639-047
E13 9531	9EL 136 825-011	E17 278	2ZR 964 169-517	E17 801	9EL 964 289-001	E17 9605	2PS 963 639-051
E13 9531	9EL 136 833-011	E17 338	8RW 341 421-001	E17 801	9EL 964 290-001	E17 9605	2PS 963 639-057
E15 31	9EL 141 701-001	E17 338	8RA 004 412-001	E17 803	2PF 006 717-011	E17 9605	2PS 963 639-061
E15 31	9EL 141 702-001	E17 338	8RA 004 412-011	E17 803	9EL 141 135-011	E17 9605	2PS 963 639-067
E17 0001	2PG 008 434-001	E17 338	8RA 004 412-021	E17 804	2SA 006 717-001	E17 9605	2PS 963 639-071
E17 0002	2PG 963 639-401	E17 338	8RA 004 412-041	E17 804	2SA 006 717-007	E17 9605	2PS 963 639-077
E17 0002	2PG 963 639-411	E17 338	9EL 963 561-801	E17 804	9EL 141 135-001	E17 9605	2PS 963 639-081
E17 0005	2VB 341 032-111	E17 338	9EL 963 561-811	E17 805	2XS 963 959-031	E17 9605	2PS 963 639-091
E17 0005	2VB 341 032-117	E17 339	8RA 002 016-121	E17 805	2XS 963 959-037	E17 9605	2PS 963 639-097
E17 0005	2VB 341 032-121	E17 346	2XL 004 762-001	E17 805	9EL 963 984-001	E17 9605	2PS 963 639-101
E17 0005	2VB 341 032-127	E17 346	8RA 002 020-001	E17 808	2DA 964 169-001	E17 9605	2PS 963 639-111
E17 0005	2VB 341 032-141	E17 346	8RA 002 020-002	E17 808	2DA 964 169-007	E17 9605	2PS 963 639-117
E17 0102	2SD 001 685-347	E17 346	8RA 002 020-003	E17 808	2DA 964 169-727	E17 9605	2PS 963 639-127
E17 0202	2PS 964 295-051	E17 346	8RA 002 020-031	E17 808	9EL 964 526-001	E17 9605	2PS 963 639-137
E17 0202	2PS 964 295-057	E17 346	8RA 002 020-051	E17 810	2SA 964 169-091	E17 9605	2PS 963 639-147
E17 0202	2PS 964 295-061	E17 353	8RB 004 713-001	E17 810	2SA 964 169-097	E17 9605	2PS 963 639-157
E17 0202	2PS 964 295-067	E17 378	2PG 006 717-021	E17 810	2SA 964 169-277	E17 9605	2PS 963 639-167
E17 0202	2PS 964 295-071	E17 378	2PG 006 717-022	E17 810	9EL 964 535-001	E17 9605	2PS 963 639-177
E17 0202	2PS 964 295-077	E17 378	2PG 006 717-027	E17 811	2PF 964 295-021	E17 9605	2PS 963 639-197
E17 0202	2PS 964 295-081	E17 378	2PS 006 717-031	E17 811	2PF 964 295-027	E17 9605	2PS 963 639-207



Type Approval Numbers

E17 9701	2VP 007 907-031	E24 5853	2PS 343 690-007	E4 01441	9EL 144 431-001	E4 10203	2SD 343 130-011
E17 9701	2VP 007 907-037	E24 5854	2BE 980 690-101	E4 01441	9EL 144 431-801	E4 10203	2SD 343 130-017
E17 9701	2VP 007 907-041	E24 0001	2PT 980 680-101	E4 10	1L6 002 395-261	E4 10203	2SD 343 130-071
E17 9701	2VP 007 907-047	E24 0001	2PT 980 680-601	E4 10	1L6 002 395-842	E4 10203	2SD 343 130-137
E17 9701	9EL 150 965-001	E24 0001	2PT 980 680-821	E4 10139	2SK 008 679-811	E4 10203	2SD 343 130-147
E17 9701	9EL 150 966-001	E24 0051	2PF 959 570-202	E4 10139	2SK 008 679-831	E4 10203	2SD 343 130-157
E17 9704	2PS 963 959-001	E24 0051	2PF 959 570-207	E4 10139	2VP 008 679-111	E4 10203	2SD 343 130-167
E17 9704	2PS 963 959-007	E24 0051	2PF 959 570-212	E4 10139	2VP 008 679-121	E4 10203	2SD 343 130-227
E17 9704	2PS 963 959-011	E24 0051	2PF 959 570-217	E4 10139	9EL 008 679-841	E4 10203	2SD 343 130-337
E17 9704	2PS 963 959-017	E24 0054	2PF 959 590-202	E4 10148	2VA 998 232-547	E4 10203	2SD 343 130-377
E17 9704	9EL 963 982-001	E24 0054	2PF 959 590-207	E4 10148	2VB 998 232-537	E4 10203	2SD 343 130-397
E17 9705	2PG 963 959-021	E24 0054	2PF 959 590-212	E4 10151	2BA 008 805-051	E4 10203	2SD 343 130-737
E17 9705	2PG 963 959-027	E24 0054	2PF 959 590-217	E4 10151	2BA 008 805-057	E4 10203	2SD 343 130-747
E17 9705	9EL 963 983-001	E24 0054	2PF 959 590-218	E4 10151	2BA 008 805-187	E4 10203	2SD 343 130-797
E17 9801	2BN 344 169-097	E24 0054	2PF 959 590-237	E4 10151	2DA 008 805-011	E4 10203	2SD 343 130-807
E17 9801	2BN 344 169-107	E24 0054	2PF 959 590-257	E4 10151	2DA 008 805-017	E4 10206	1LL 263 064-031
E17 9801	2BN 964 169-051	E24 5850	2BA 980 607-201	E4 10151	2NE 008 805-031	E4 10206	1LL 263 064-041
E17 9801	2BN 964 169-057	E24 5850	2BA 980 607-701	E4 10151	2NE 008 805-037	E4 10207	1LL 263 064-031
E17 9801	2BN 964 169-247	E24 5850	2SB 980 606-201	E4 10151	2SA 008 805-001	E4 10207	1LL 263 064-041
E17 9801	2BN 964 169-777	E24 5850	2SB 980 606-701	E4 10151	2SA 008 805-007	E4 10207	1ZS 263 064-531
E17 9801	2BN 964 169-787	E24 5850	2ZR 980 605-201	E4 10151	2SB 008 805-021	E4 10207	1ZS 263 064-541
E17 9801	2NE 344 169-067	E24 5850	2ZR 980 605-701	E4 10151	2SB 008 805-027	E4 10208	2BA 959 822-601
E17 9801	2NE 344 169-117	E24 5852	2PT 010 458-801	E4 10151	2ZR 008 805-041	E4 10208	2NE 959 821-201
E17 9802	2BE 964 169-071	E24 5852	2PT 010 458-811	E4 10151	2ZR 008 805-047	E4 10208	2SB 959 821-601
E17 9802	2BE 964 169-077	E24 5852	2PT 010 458-821	E4 10162	2VA 998 233-171	E4 10208	2ZR 959 820-601
E17 9802	9EL 964 533-001	E24 5852	2PT 010 458-831	E4 10162	2VA 998 233-271	E4 10215	2BA 965 039-021
E17 9803	2SW 964 169-081	E24 5852	2PT 010 458-841	E4 10162	2VA 998 233-357	E4 10215	2BA 965 039-027
E17 9803	2SW 964 169-087	E24 5852	2PT 010 458-851	E4 10162	2VA 998 233-367	E4 10215	2BA 965 039-061
E17 9803	9EL 964 534-001	E24 5852	2PT 010 458-861	E4 10162	2VP 998 233-281	E4 10215	2BA 965 039-067
E17 9804	2BA 964 169-041	E24 5852	2PT 010 458-871	E4 10162	9EL 990 633-011	E4 10215	2BA 965 039-101
E17 9804	2BA 964 169-047	E24 5852	2PT 177 696-801	E4 10162	9EL 990 633-021	E4 10215	2BA 965 039-107
E17 9804	2BA 964 169-237	E24 5853	2PS 343 690-017	E4 10162	9EL 990 633-031	E4 10215	2BA 965 039-141
E17 9804	9EL 964 530-001	E24 5853	2PS 343 690-037	E4 10162	9EL 990 633-041	E4 10215	2BA 965 039-147
E17 9805	2SB 964 169-287	E24 5853	2PS 343 690-057	E4 10170	1LL 010 203-041	E4 10215	2DA 965 039-011
E17 9805	2SB 964 169-531	E24 5857	2NE 344 610-007	E4 10178	1LL 010 201-031	E4 10215	2DA 965 039-091
E17 9805	2SB 964 169-537	E24 5860	8RA 344 610-017	E4 10178	1LL 010 201-041	E4 10215	2DA 965 039-317
E17 9805	2SB 964 169-677	E26 001	2VA 980 720-001	E4 10178	1LL 010 201-071	E4 10215	2NE 965 039-031
E17 9805	2SB 964 169-717	E26 002	2VA 980 720-007	E4 10178	1LL 010 201-081	E4 10215	2NE 965 039-037
E17 9805	2TA 344 169-077	E26 003	1NB 008 122-011	E4 10178	1LL 010 201-111	E4 10215	2NE 965 039-111
E17 9805	2TA 344 169-087	E26 003	1NB 008 122-021	E4 10178	1LL 010 201-121	E4 10215	2NE 965 039-117
E17 9805	2TA 964 169-061	E26 003	9EL 270 107-011	E4 10178	1LL 010 201-151	E4 10215	2NE 965 039-327
E17 9805	2TA 964 169-067	E26 003	1NO 270 204-051	E4 10178	1LL 010 201-161	E4 10215	2PF 965 039-071
E17 9805	2TA 964 169-767	E26 004	1NO 270 204-061	E4 10178	1LL 010 201-191	E4 10215	2PF 965 039-077
E17 9805	2TA 964 169-797	E26 004	1NO 270 255-051	E4 10178	1LL 010 201-201	E4 10215	2PF 965 039-151
E17 9805	9EL 964 532-001	E26 004	1NO 270 255-061	E4 10178	1LL 010 201-231	E4 10215	2PT 965 039-171
E17 9806	2PG 964 295-011	E26 004	1NO 271 022-051	E4 10178	1LL 010 201-241	E4 10215	2PT 965 039-177
E17 9806	2PG 964 295-017	E26 004	1NO 271 022-061	E4 10179	1LL 010 201-031	E4 10215	2SA 965 039-001
E17 9807	2PS 964 295-001	E26 004	1NO 271 247-051	E4 10179	1LL 010 201-041	E4 10215	2SA 965 039-007
E17 9807	2PS 964 295-007	E26 004	1NO 271 247-061	E4 10179	1LL 010 201-071	E4 10215	2SA 965 039-081
E17 9808	2TM 963 639-307	E26 004	2BA 270 016-031	E4 10179	1LL 010 201-081	E4 10215	2SA 965 039-087
E17 9808	2TM 963 639-317	E26 004	2BA 270 016-041	E4 10179	1LL 010 201-111	E4 10215	2SA 965 039-307
E17 9823	2SD 964 169-401	E26 007	1NO 270 481-051	E4 10179	1LL 010 201-121	E4 10215	2SB 965 039-051
E17 9823	2SD 964 169-411	E26 007	1NO 270 481-061	E4 10179	1LL 010 201-151	E4 10215	2SB 965 039-057
E17 9823	2SD 964 169-421	E26 008	1NO 270 596-051	E4 10179	1LL 010 201-161	E4 10215	2SB 965 039-131
E17 9903	2SD 964 169-111	E26 008	1NO 270 596-061	E4 10179	1LL 010 201-191	E4 10215	2SB 965 039-137
E17 9903	2SD 964 169-117	E26 012	1NO 270 595-011	E4 10179	1LL 010 201-201	E4 10215	2ZR 965 039-041
E17 9903	9EL 964 536-001	E26 012	1NO 270 595-021	E4 10179	1LL 010 201-231	E4 10215	2ZR 965 039-047
E2 164	2SD 003 409-181	E26 015	1NO 271 289-031	E4 10179	1LL 010 201-241	E4 10215	2ZR 965 039-121
E2 164	2SD 003 409-317	E26 015	1NO 271 289-041	E4 10180	1LL 010 201-031	E4 10215	2ZR 965 039-127
E2 164	2SD 003 409-327	E26 015	1NO 271 295-031	E4 10180	1LL 010 201-041	E4 10215	2ZR 965 039-337
E2 164	2SE 003 409-171	E26 015	1NO 271 295-041	E4 10180	1LL 010 201-071	E4 10217	2VA 341 419-077
E2 167	9EL 119 544-001	E26 016	1NO 271 296-031	E4 10180	1LL 010 201-081	E4 10217	2VA 341 419-097
E2 32764	9EL 119 544-101	E26 016	1NO 271 296-041	E4 10180	1LL 010 201-111	E4 10217	2VA 341 419-167
E2 7078	2VD 008 789-011	E26 017	1NO 271 284-031	E4 10180	1LL 010 201-121	E4 10217	2VA 341 419-187
E2 7078	2VP 008 789-021	E26 017	1NO 271 284-041	E4 10180	1LL 010 201-151	E4 10217	2VP 341 419-087
E2 7078	2VP 008 789-041	E26 901	9EL 270 197-011	E4 10180	1LL 010 201-161	E4 10217	2VP 341 419-107
E2 7078	2VP 008 789-051	E26 901	9EL 270 198-011	E4 10180	1LL 010 201-191	E4 10217	2VP 341 419-157
E2 7078	2VP 008 789-071	E4 0002	2PS 002 727-001	E4 10180	1LL 010 201-201	E4 10217	2VP 341 419-177
E2 88072	9EL 856 415-001	E4 0002	2PS 004 361-001	E4 10180	1LL 010 201-231	E4 10218	2VP 340 888-001
E2 88072	9EL 856 416-001	E4 0002	2PS 004 361-007	E4 10180	1LL 010 201-241	E4 10218	2VP 340 888-007
E2 88072	9EL 856 416-011	E4 0003	2PS 002 727-001	E4 10184	1LL 010 203-031	E4 10218	2VP 340 888-011
E2 88072	9EL 856 417-001	E4 0003	2PS 004 361-001	E4 10202	2BE 343 130-001	E4 10218	2VP 340 888-017
E2 88072	9EL 856 418-001	E4 0003	2PS 004 361-007	E4 10202	2BE 343 130-007	E4 10219	2VP 340 888-001
E2 88072	9EL 856 418-011	E4 0004	2PS 962 964-012	E4 10202	2BE 343 130-081	E4 10219	2VP 340 888-007
E2 92031	8RA 003 326-031	E4 0004	2PS 962 964-018	E4 10202	2BE 343 130-657	E4 10219	2VP 340 888-011
E2 92031	8RA 003 326-041	E4 0004	2PS 962 964-031	E4 10202	2BE 343 130-667	E4 10219	2VP 340 888-017
E2 92031	8RA 003 326-047	E4 0004	2PS 962 964-037	E4 10202	2BE 343 130-777	E4 10222	1LE 247 013-071
E2 92031	8RA 003 326-051	E4 0009	1FO 010 186-001	E4 10202	2BE 343 130-787	E4 10222	1LE 247 013-081
E2 92031	8RA 003 326-931	E4 0009	1FO 010 186-201	E4 10202	2BE 344 130-777	E4 10222	1LE 247 013-851

Type Approval Numbers



E4 10223	1LE 247 013-071	E4 12658	2SB 344 200-087	E4 23152	9EL 114 401-001	E4 280	2XS 007 841-027
E4 10223	1LE 247 013-081	E4 12658	2SD 344 200-001	E4 23152	9EL 114 401-031	E4 280	9EL 146 887-001
E4 10223	1LE 247 013-851	E4 12658	2SD 344 200-007	E4 23152	9EL 114 401-041	E4 281	9EL 145 997-021
E4 10224	1LL 247 014-031	E4 12658	2SD 344 200-071	E4 23167	2SK 005 883-011	E4 281	9EL 145 998-021
E4 10224	1LL 247 014-041	E4 12658	2SD 344 200-077	E4 23167	2SK 005 883-021	E4 3	9EL 114 401-001
E4 10225	1LL 247 014-031	E4 12659	1LL 354 689-031	E4 23167	2SL 005 883-031	e4 305	9EL 135 548-001
E4 10225	1LL 247 014-041	E4 12659	1LL 354 689-041	E4 23167	2SL 005 883-041	E4 3092	9EL 151 127-001
E4 10225	1LL 247 014-841	E4 12659	1ZS 354 690-031	e4 23167	9EL 135 548-001	E4 3092	9EL 151 128-001
E4 10230	2SK 008 659-091	E4 12659	1ZS 354 690-041	E4 2318	9EL 113 065-001	E4 311	9EL 123 209-005
E4 10230	2SK 008 659-101	E4 12659	1ZS 354 692-031	E4 2319	9EL 138 649-031	E4 311	9EL 123 210-005
E4 10230	2SK 008 659-111	E4 12661	1ZS 354 692-041	E4 2319	9EL 138 649-041	E4 311	9EL 151 127-001
E4 10230	2SK 008 659-121	E4 12677	2VP 343 520-017	E4 2319	9EL 138 650-031	E4 311	9EL 151 128-001
E4 10233	1LF 354 025-111	E4 12677	2VP 343 520-027	E4 2319	9EL 138 650-041	E4 3134	2VD 003 567-377
E4 10234	1LF 354 025-121	E4 1305	2SK 005 883-011	E4 23215	2SK 003 567-321	E4 3134	2VP 003 567-111
E4 10236	2PS 009 226-017	E4 1305	2SK 005 883-021	E4 23215	2SK 003 567-331	E4 3134	2VP 003 567-121
E4 10236	2PS 009 226-021	E4 1305	2SL 005 883-031	E4 23215	2SK 003 567-651	E4 3134	2VP 003 567-127
E4 10236	2PS 009 226-027	E4 1305	2SL 005 883-041	E4 23215	2SK 003 567-661	E4 3134	9EL 122 689-021
E4 10236	2PS 009 226-037	E4 13136	2SD 344 100-001	E4 23215	2SL 003 567-311	E4 3153	2PG 962 964-041
E4 10236	2PS 009 226-067	E4 13136	2SD 344 100-007	E4 23215	2SL 003 567-691	E4 3153	2PG 962 964-051
E4 10549	9EL 008 980-801	E4 1365	2BM 009 320-807	E4 23215	2VD 003 567-377	E4 3153	2PG 962 964-057
E4 10549	9EL 008 980-811	E4 14198	2NE 344 200-061	E4 23215	2VP 003 567-111	E4 3153	2PS 962 964-012
E4 1076	2SD 959 050-401	E4 14198	2NE 344 200-067	E4 23215	2VP 003 567-121	E4 3153	2PS 962 964-018
E4 10880	2BA 008 982-041	E4 14198	2NE 344 200-091	E4 23215	2VP 003 567-127	E4 3153	2PS 962 964-031
E4 10880	2BA 008 982-047	E4 14198	2NE 344 200-097	E4 23215	9BG 130 945-001	E4 3153	2PS 962 964-037
E4 10880	2BA 008 982-341	E4 14198	2ZR 344 200-051	E4 23215	9BG 130 946-001	E4 3169	2PS 008 382-001
E4 10880	2BA 008 982-347	E4 14198	2ZR 344 200-057	E4 23215	9EL 122 689-021	E4 3169	2PS 008 382-007
E4 10880	2SB 008 982-001	E4 14204	1ZS 263 064-531	E4 23215	9EL 122 689-051	E4 3169	2PS 008 382-801
E4 10880	2SB 008 982-007	E4 14204	1ZS 263 064-541	E4 23215	9EL 122 772-001	E4 3169	2PS 008 382-807
E4 10880	2SB 008 982-301	E4 1467	2BA 007 249-011	E4 23215	9EL 122 772-051	E4 3169	2PS 008 382-811
E4 10880	2SB 008 982-307	E4 1467	2BA 007 249-021	E4 23215	9GP 003 995-801	E4 3169	2PS 008 382-817
E4 10880	2SB 008 982-367	e4 1586	2SD 959 050-401	E4 23254	2ZR 964 169-351	E4 3169	9EL 154 637-001
E4 10892	1KL 998 570-021	E4 19038	1NA 010 205-011	E4 23254	2ZR 964 169-361	E4 3178	2VD 008 204-051
E4 10892	1KL 998 570-031	E4 19038	1NA 010 205-021	E4 23255	2ZR 009 001-011	E4 3178	2VD 008 204-071
E4 10895	1ML 998 570-011	E4 19052	1NO 354 013-011	E4 23255	2ZR 009 001-017	E4 3178	2VD 008 204-131
E4 10913	1LL 009 447-111	E4 19052	1NO 354 013-021	E4 23255	2ZR 009 001-117	E4 3178	2VD 008 204-141
E4 10913	1LL 009 447-121	E4 19259	1NO 009 594-011	E4 23257	2ZR 343 130-041	E4 3178	2VD 008 204-151
E4 10914	1LL 009 447-111	E4 19259	1NO 009 594-021	E4 23257	2ZR 343 130-047	E4 3178	2VD 008 204-171
E4 10914	1LL 009 447-121	E4 19259	1NO 010 380-011	E4 23257	2ZR 343 130-317	E4 3178	2VD 008 204-191
E4 11384	1LF 238 042-031	E4 19259	1NO 010 380-021	E4 23257	2ZR 343 130-327	E4 3178	2VD 008 204-211
E4 11384	1LF 238 042-041	E4 19289	1NO 009 617-011	E4 23257	2ZR 343 130-387	E4 3178	2VD 008 204-231
E4 11384	1LF 238 042-131	E4 19481	1NA 009 033-011	E4 23257	2ZR 343 130-607	E4 3178	2VD 008 204-251
E4 11384	1LF 238 042-141	E4 19481	1NA 009 033-021	E4 23262	2ZR 996 179-701	E4 3178	2VD 008 205-011
E4 11385	1LF 238 042-031	E4 195	9EL 138 601-031	E4 2336	2ZR 001 240-351	E4 3178	2VD 008 205-021
E4 11385	1LF 238 042-041	E4 195	9EL 138 601-041	E4 2336	2ZR 001 240-377	E4 3178	2VD 008 205-041
E4 11385	1LF 238 042-131	E4 195	9EL 138 602-031	E4 2336	9EM 128 244-001	E4 3178	2VD 008 205-051
E4 11385	1LF 238 042-141	E4 195	9EL 138 602-041	E4 257	1LG 006 560-211	E4 3178	2VP 008 204-041
E4 11391	2NE 959 011-501	E4 19506	1NA 009 031-011	E4 258	1LG 006 560-221	E4 3178	2VP 008 204-061
E4 11391	2NE 959 011-507	E4 19506	1NA 009 031-021	E4 273	1LG 007 150-111	E4 3178	2VP 008 204-121
E4 11391	2ZR 959 010-501	E4 19507	1NO 010 380-011	E4 273	1LG 007 150-121	E4 3178	2VP 008 204-161
E4 11391	2ZR 959 010-507	E4 19507	1NO 010 380-021	E4 273	9EL 145 103-011	E4 3178	2VP 008 204-181
E4 11785	2SD 343 390-011	E4 19516	1NA 009 029-011	E4 273	9EL 145 104-011	E4 3178	2VP 008 204-201
E4 11785	2SD 343 390-401	E4 19516	1NA 009 029-021	E4 273	9ES 144 433-031	E4 3178	2VP 008 204-241
E4 11785	2SD 343 390-407	E4 19773	1NO 010 789-011	E4 273	9ES 144 434-031	E4 3178	2VP 008 205-031
E4 11785	2SD 343 390-417	E4 19773	1NO 010 789-021	E4 278	9EL 151 127-001	E4 3178	9EL 152 884-001
E4 12371	2SD 344 200-001	E4 19805	1NO 010 846-011	E4 278	9EL 151 128-001	E4 3178	9EL 152 889-001
E4 12371	2SD 344 200-007	E4 19805	1NO 010 846-021	E4 278	2VD 007 323-031	E4 3179	2VD 008 204-091
E4 12371	2SD 344 200-071	E4 19835	1NO 010 843-011	E4 279	2VD 007 323-041	E4 3179	2VD 008 204-111
E4 12371	2SD 344 200-077	E4 19835	1NO 010 843-021	E4 279	2VD 007 323-131	E4 3179	2VP 008 204-081
E4 12373	2BA 959 011-301	E4 19836	1NO 010 845-011	E4 279	2VD 007 323-141	E4 3179	2VP 008 204-101
E4 12373	2BA 959 011-307	E4 19836	1NO 010 845-021	E4 279	2VP 007 323-011	E4 3179	9EL 152 891-001
E4 12373	2SB 959 010-301	E4 19841	1NO 010 844-011	E4 279	2VP 007 323-021	E4 3189	8RA 009 001-031
E4 12373	2SB 959 010-307	E4 19841	1NO 010 844-021	E4 279	2VP 007 323-091	E4 3189	8RA 009 001-037
E4 12386	2BA 008 982-217	E4 2	9EL 114 401-001	E4 279	2VP 007 323-101	E4 3190	8RA 343 160-002
E4 12386	2SB 008 982-207	E4 2032	1LL 009 300-071	E4 279	2VP 007 323-111	E4 3190	8RA 343 160-007
E4 12390	2BA 009 001-411	E4 2032	1LL 009 300-081	E4 279	2VP 007 323-121	E4 3190	8RA 343 160-012
E4 12390	2BA 009 001-511	E4 2032	1LL 009 300-831	E4 279	9EL 146 887-001	E4 3190	8RA 343 160-017
E4 12390	2PF 009 001-421	E4 2033	1LL 009 300-071	E4 280	2VD 007 323-031	E4 3190	8RA 343 160-022
E4 12390	2PF 009 001-521	E4 2033	1LL 009 300-081	E4 280	2VD 007 323-041	E4 3190	8RA 343 160-027
E4 12390	2SB 009 001-401	E4 2033	1LL 009 300-831	E4 280	2VD 007 323-131	E4 3191	8RA 343 220-007
E4 12390	2SB 009 001-501	E4 227	9EL 144 131-001	E4 280	2VD 007 323-141	E4 3191	8RA 343 220-017
E4 12393	2SD 343 910-017	E4 227	9EL 144 132-001	E4 280	2VP 007 323-011	E4 3302	8RA 009 362-001
E4 1247	2SK 005 883-011	E4 23152	2PG 002 727-021	E4 280	2VP 007 323-021	E4 3322	8RA 344 065-007
E4 1247	2SK 005 883-021	E4 23152	2PG 004 361-011	E4 280	2VP 007 323-091	E4 334	1L6 002 395-261
E4 1247	2SL 005 883-031	E4 23152	2PG 004 361-017	E4 280	2VP 007 323-101	E4 361	2BA 006 091-011
E4 1247	2SL 005 883-041	E4 23152	2PS 002 727-001	E4 280	2VP 007 323-111	E4 361	2BA 006 091-021
e4 1247	9EL 135 548-001	E4 23152	2PS 004 361-001	E4 280	2VP 007 323-121	E4 377	2SK 003 567-321
E4 12658	2BA 344 200-037	E4 23152	2PS 004 361-007	E4 280	2XS 007 841-011	E4 377	2SK 003 567-331
E4 12658	2SB 344 200-027	E4 23152	2TM 004 361-021	E4 280	2XS 007 841-017	E4 377	2SK 003 567-651
E4 12658	2SB 344 200-081	E4 23152	9EL 114 400-015	E4 280	2XS 007 841-021	E4 377	2SK 003 567-661



Type Approval Numbers

E4 377	2SL 003 567-311	E4 4033	2VD 003 567-377	E4 468	9EL 114 400-015	E4 6550	2BA 343 390-071
E4 377	2SL 003 567-691	E4 4033	9EL 122 689-021	E4 468	9EL 114 401-031	E4 6550	2BA 344 130-747
E4 377	2VD 003 567-377	E4 4033	9EL 122 689-051	E4 469	2PG 002 727-021	E4 6551	2BA 009 204-041
E4 377	2VP 003 567-111	E4 4033	9EL 122 772-001	E4 469	2PG 004 361-011	E4 6551	2BA 009 204-051
E4 377	2VP 003 567-121	E4 4039	2VD 007 323-031	E4 469	2PG 004 361-017	E4 6551	2BA 009 204-057
E4 377	2VP 003 567-127	E4 4039	2VD 007 323-041	E4 469	9EL 114 400-015	E4 7499	2PF 962 964-061
E4 377	9BG 130 945-001	E4 4039	2VD 007 323-131	E4 469	9EL 114 401-031	E4 7499	2PF 962 964-071
E4 377	9BG 130 946-001	E4 4039	2VD 007 323-141	E4 474	9EL 158 254-011	E4 7499	2PG 962 964-041
E4 377	9EL 122 689-021	E4 4039	2VP 007 323-011	E4 474	9EL 158 254-021	E4 7499	2PG 962 964-051
E4 377	9EL 122 689-051	E4 4039	2VP 007 323-021	E4 489	1LG 354 023-031	E4 7499	2PG 962 964-057
E4 377	9EL 122 772-001	E4 4039	2VP 007 323-091	E4 489	1LG 354 023-041	E4 7504	2SE 998 530-061
E4 377	9EL 122 772-051	E4 4039	2VP 007 323-101	E4 491	1LG 354 023-071	E4 7504	2SE 998 530-067
E4 377	9GP 003 995-801	E4 4039	2VP 007 323-111	E4 491	1LG 354 023-081	E4 7507	2SA 962 964-091
E4 3848	2SK 005 883-011	E4 4039	2VP 007 323-121	E4 53	1L6 002 395-261	E4 7547	2DA 959 071-037
E4 3848	2SK 005 883-021	E4 4039	9EL 146 887-001	E4 5851	2BA 959 932-051	E4 7547	2DA 959 071-237
E4 3848	2SL 005 883-031	E4 4044	2SE 998 530-061	E4 6478	9EL 246 175-011	E4 7547	2DA 959 071-537
E4 3848	2SL 005 883-041	E4 4044	2SE 998 530-067	E4 6478	9EL 246 176-011	E4 7547	2DA 959 071-737
E4 3848	9EL 135 548-001	E4 4060	2VD 008 204-051	E4 6484	2SE 998 530-061	E4 7547	2DA 959 071-757
E4 3880	2SK 003 567-321	E4 4060	2VD 008 204-071	E4 6484	2SE 998 530-067	E4 7574	2XA 959 560-401
E4 3880	2SK 003 567-331	E4 4060	2VD 008 204-091	E4 6495	9EL 990 186-001	E4 7574	2XA 959 560-407
E4 3880	2SK 003 567-651	E4 4060	2VD 008 204-111	E4 6504	9EL 857 801-001	E4 7574	2XA 959 560-411
E4 3880	2SK 003 567-661	E4 4060	2VD 008 204-131	E4 6504	9EL 857 803-001	E4 7574	2XA 959 560-417
E4 3880	2SL 003 567-311	E4 4060	2VD 008 204-141	E4 6506	9EL 856 415-001	E4 7575	2PF 959 570-401
E4 3880	2SL 003 567-691	E4 4060	2VD 008 204-151	E4 6506	9EL 856 416-001	E4 7575	2PF 959 570-407
E4 3880	2VD 003 567-377	E4 4060	2VD 008 204-171	E4 6506	9EL 856 416-011	E4 7575	2PF 959 570-411
E4 3880	2VP 003 567-111	E4 4060	2VD 008 204-191	E4 6509	2RL 006 846-001	E4 7575	2PF 959 570-417
E4 3880	2VP 003 567-121	E4 4060	2VD 008 204-211	E4 6509	2RL 006 846-011	E4 7575	2PF 959 570-427
E4 3880	2VP 003 567-127	E4 4060	2VD 008 204-231	E4 6509	2RL 007 337-001	E4 7597	2PF 959 590-401
E4 3880	9BG 130 945-001	E4 4060	2VD 008 204-251	E4 6509	2RL 007 337-011	E4 7597	2PF 959 590-407
E4 3880	9BG 130 946-001	E4 4060	2VD 008 205-011	E4 6509	2RL 007 337-021	E4 7597	2PF 959 590-411
E4 3880	9EL 122 689-021	E4 4060	2VD 008 205-021	E4 6509	2RL 007 337-031	E4 7597	2PF 959 590-417
E4 3880	9EL 122 772-001	E4 4060	2VD 008 205-041	E4 6509	2RL 007 337-041	E4 7597	2PF 959 590-437
E4 3880	9GP 003 995-801	E4 4060	2VD 008 205-051	E4 6509	2RL 007 337-057	E4 7597	2PF 959 590-457
E4 3884	9EL 138 649-031	E4 4060	2VP 008 205-031	E4 6509	9EL 859 020-001	E4 7597	2XA 959 790-401
E4 3884	9EL 138 649-041	E4 4060	9EL 152 884-001	E4 6510	2RL 007 017-041	E4 7597	2XA 959 790-407
E4 3884	9EL 138 650-031	E4 4060	9EL 152 889-001	E4 6510	2RL 007 017-051	E4 7597	2XA 959 790-411
E4 3884	9EL 138 650-041	E4 4060	9EL 152 891-001	E4 6510	9EL 859 658-001	E4 7613	2DA 009 001-051
E4 3917	2NE 009 001-021	E4 4068	2KA 959 640-102	E4 6511	2RL 007 017-061	E4 7613	2DA 009 001-057
E4 3917	2NE 009 001-027	E4 4068	2KA 959 640-607	E4 6511	2RL 007 017-071	E4 7613	2DA 009 001-147
E4 3917	2NE 009 001-127	E4 410	9EL 138 649-031	E4 6511	9EL 859 658-011	E4 7613	2PF 009 001-081
E4 3919	2NE 343 130-031	E4 410	9EL 138 649-041	E4 6512	9EL 857 576-021	E4 7613	2PF 009 001-177
E4 3919	2NE 343 130-037	E4 410	9EL 138 650-031	E4 6512	9EL 857 576-031	E4 7613	2SA 009 001-041
E4 3919	2NE 343 130-177	E4 410	9EL 138 650-041	E4 6513	2RL 006 846-101	E4 7613	2SA 009 001-047
E4 3919	2NE 343 130-277	E4 4119	1N0 354 018-011	E4 6513	2RL 006 846-111	E4 7613	2SA 009 001-137
E4 3919	2NE 343 130-287	E4 4119	1N0 354 018-021	E4 6513	2RL 007 337-101	E4 7613	2SB 009 001-061
E4 396	2SK 003 567-321	E4 421	2VP 003 567-111	E4 6513	2RL 007 337-111	E4 7613	2SB 009 001-067
E4 396	2SK 003 567-331	E4 421	2VP 003 567-121	E4 6513	2RL 007 337-121	E4 7613	2SB 009 001-157
E4 396	2SK 003 567-651	E4 421	2VP 003 567-127	E4 6513	9EL 859 020-101	E4 7696	2DA 343 106-001
E4 396	2SK 003 567-661	E4 421	9BG 130 945-001	E4 6514	2RL 007 550-001	E4 7696	2DA 343 106-007
E4 396	2SL 003 567-311	E4 421	9BG 130 946-001	E4 6514	2RL 007 550-011	E4 7696	2DA 343 106-011
E4 396	2SL 003 567-691	E4 421	9EL 122 689-021	E4 6514	2RL 007 550-021	E4 7696	2DA 343 106-017
E4 396	2VD 003 567-377	E4 421	9EL 122 689-051	E4 6514	2RL 007 551-001	E4 7696	2DA 343 106-021
E4 396	9EL 122 772-001	E4 421	9EL 122 772-001	E4 6514	2RL 007 551-011	E4 7696	2DA 343 106-027
E4 397	2SK 003 567-321	E4 421	9EL 122 772-051	E4 6514	2RL 007 551-021	E4 7696	2DA 343 106-031
E4 397	2SK 003 567-331	E4 421	9GP 003 995-801	E4 6514	2RL 007 552-001	E4 7696	2DA 343 106-037
E4 397	2SK 003 567-651	E4 426	9BG 142 247-021	E4 6514	2RL 007 552-011	E4 7696	2DA 343 106-201
E4 397	2SK 003 567-661	E4 426	9BG 142 248-021	E4 6514	2RL 007 552-021	E4 7696	2DA 343 106-207
E4 397	2SL 003 567-311	E4 439	9EL 144 425-001	E4 6514	2RL 007 553-001	E4 7696	2DA 343 106-211
E4 397	2SL 003 567-691	E4 439	9EL 144 426-001	E4 6514	2RL 007 553-011	E4 7696	2DA 343 106-217
E4 397	2VD 003 567-377	E4 440	9EL 144 425-011	E4 6514	2RL 007 553-021	E4 7696	2DA 343 106-221
E4 397	2VP 003 567-111	E4 440	9EL 144 426-011	E4 6514	9EL 860 627-001	E4 7696	2DA 343 106-227
E4 397	2VP 003 567-121	E4 4449	9EL 138 601-041	E4 6514	9EL 860 627-011	E4 7696	2DA 343 106-231
E4 397	2VP 003 567-127	E4 4449	9EL 138 602-041	E4 6516	2RL 007 900-701	E4 7696	2DA 343 106-237
E4 397	9BG 130 945-001	E4 453	2PF 007 205-001	E4 6546	2BA 009 001-001	E4 7698	2SB 343 130-027
E4 397	9BG 130 946-001	E4 453	2PF 007 205-007	E4 6546	2BA 009 001-007	E4 7698	2SB 343 130-757
E4 397	9EL 122 689-021	E4 453	2PF 007 205-017	E4 6546	2BA 009 001-071	E4 7698	2SB 343 130-767
E4 397	9EL 122 689-051	E4 455	9EL 145 833-021	E4 6546	2BA 009 001-077	E4 7698	2SB 343 390-091
E4 397	9EL 122 772-001	E4 455	9EL 145 834-021	E4 6546	2BA 009 001-107	E4 7705	2DA 343 130-257
E4 397	9EL 122 772-051	E4 464	9EL 246 151-021	E4 6546	2BA 009 001-167	E4 7705	2DA 343 130-267
E4 397	9GP 003 995-801	E4 464	9EL 246 152-021	E4 6546	2BA 009 001-191	E4 7715	2DA 343 800-001
E4 40	1L6 002 395-261	E4 466	2TM 004 361-021	E4 6546	2BA 009 001-201	E4 7715	2DA 343 800-007
E4 402	2BA 006 728-801	E4 466	9EL 114 401-041	E4 6550	2BA 343 130-051	E4 7715	2DA 343 800-047
E4 4026	2SK 005 883-011	E4 467	2BA 007 249-011	E4 6550	2BA 343 130-057	E4 7715	2DA 343 800-057
E4 4026	2SK 005 883-021	E4 467	2BA 007 249-021	E4 6550	2BA 343 130-297	E4 7747	2SB 009 362-011
E4 4026	2SL 005 883-031	E4 467	2TM 004 361-021	E4 6550	2BA 343 130-307	E4 7747	2SB 009 362-021
E4 4026	2SL 005 883-041	E4 467	9EL 114 401-041	E4 6550	2BA 343 130-537	E4 7747	2SB 009 362-041
E4 4026	9EL 135 548-001	E4 468	2PG 002 727-021	E4 6550	2BA 343 130-547	E4 7748	2SB 009 362-011
E4 4033	2SL 003 567-311	E4 468	2PG 004 361-011	E4 6550	2BA 343 130-577	E4 7748	2SB 009 362-021
E4 4033	2SL 003 567-691	E4 468	2PG 004 361-017	E4 6550	2BA 343 130-587	E4 7748	2SB 009 362-041

Type Approval Numbers



E4 8478	1LG 354 024-051	E4 9808	2VD 008 205-041	E4 9837	1LD 246 044-241	E8 71-27	9EL 997 332-001
E4 8478	1LG 354 024-061	E4 9808	2VD 008 205-051	E4 9837	1LD 247 026-271	E8 71-28	2SE 997 008-001
E4 8478	1LG 354 024-071	E4 9808	2VP 008 204-041	E4 9837	1LD 247 026-281	E8 71-28	9EL 997 332-001
E4 8478	1LG 354 024-081	E4 9808	2VP 008 204-061	E4 9838	1LD 246 044-231	E8 7305	2BE 997 006-101
E4 9110	2PS 008 138-001	E4 9808	2VP 008 204-121	E4 9838	1LD 246 044-241	E8 7306	2BE 997 006-101
E4 9110	2PS 008 138-101	E4 9808	2VP 008 204-161	E4 9838	1LD 247 026-271	E9 0019	1NA 907 312-111
E4 9110	2PS 008 138-111	E4 9808	2VP 008 204-181	E4 9838	1LD 247 026-281	E9 0019	1NA 907 312-121
E4 9110	2PS 008 138-801	E4 9808	2VP 008 204-201	E4 9849	1LG 010 196-031	E9 0019	1NA 961 557-731
E4 9110	2PS 008 138-811	E4 9808	2VP 008 204-221	E4 9849	1LG 010 196-041	E9 0019	1NA 961 557-741
E4 9110	2PS 008 138-821	E4 9808	2VP 008 204-241	E6 1375	2SL 007 547-061	E9 0019	1NA 961 557-751
E4 914	1NE 002 537-201	E4 9808	2VP 008 205-031	E6 1375	2SL 007 547-067	E9 0019	1NA 961 557-761
E4 914	1NE 002 537-301	E4 9808	9EL 152 884-001	E6 1375	2VD 007 547-181	E9 0019	1NA 963 022-031
E4 915	1N4 002 608-021	E4 9808	9EL 152 889-001	E6 1375	9EL 147 097-001	E9 0019	1NA 963 022-041
E4 9374	2XS 007 841-011	E4 9809	2VD 008 204-091	E6 3018	2VB 007 547-171	E9 15034	2BA 961 554-111
E4 9374	2XS 007 841-017	E4 9809	2VD 008 204-111	E6 3018	2VD 007 547-181	E9 15034	2BA 961 554-121
E4 9374	2XS 007 841-021	E4 9809	2VP 008 204-081	E6 450	2SE 007 547-011	E9 1538	2SD 959 010-401
E4 9374	2XS 007 841-027	E4 9809	2VP 008 204-101	E6 450	2SE 007 547-017	E9 1538	2SD 959 010-407
E4 9377	1LF 007 520-071	E4 9809	9EL 152 891-001	E6 450	2SE 007 547-021	E9 5048	2BA 919 370-051
E4 9377	1LF 007 620-071	E4 981	2BA 964 255-021	E6 450	2SE 007 547-027	E9 5048	2BA 919 370-061
E4 9378	1LF 007 520-081	E4 981	2BA 964 255-041	E6 450	2SE 007 547-041	E9 5167	2VD 008 789-011
E4 9378	1LF 007 620-081	E4 9810	2VD 008 204-071	E6 450	2SL 007 547-061	E9 5167	2VP 008 789-021
E4 9417	2PS 007 943-011	E4 9810	2VD 008 204-091	E6 450	2SL 007 547-067	E9 5167	2VP 008 789-041
E4 9417	2PS 007 943-017	E4 9810	2VD 008 204-111	E6 450	2VB 007 547-171	E9 5167	2VP 008 789-051
E4 9417	2PS 007 943-021	E4 9810	2VD 008 204-131	E6 450	2VD 007 547-181	E9 5167	2VP 008 789-071
E4 9417	2PS 007 943-027	E4 9810	2VD 008 204-141	E6 450	9EL 147 096-001	E9 5447	2VA 998 232-251
E4 9417	2PS 007 943-311	E4 9810	2VD 008 204-151	E6 450	9EL 147 097-001	E9 5447	2VA 998 232-291
E4 9417	2PS 007 943-317	E4 9810	2VD 008 204-171	E6 451	2SE 007 547-011	E9 5447	2VB 998 232-011
E4 9417	2PS 007 943-321	E4 9810	2VD 008 204-191	E6 451	2SE 007 547-017	E9 5447	2VB 998 232-021
E4 9457	9EL 963 669-081	E4 9810	2VD 008 204-211	E6 451	2SE 007 547-021	E9 5447	2VB 998 232-057
E4 9457	9EL 963 670-081	E4 9810	2VD 008 204-231	E6 451	2SE 007 547-027	E9 5447	2VB 998 232-101
E4 9476	1LG 354 024-131	E4 9810	2VD 008 204-251	E6 451	2SE 007 547-041	E9 5447	2VB 998 232-131
E4 9476	1LG 354 024-141	E4 9810	2VP 008 204-061	E6 451	2SL 007 547-061	E9 5447	2VB 998 232-171
E4 9496	1LA 990 185-011	E4 9810	2VP 008 204-081	E6 451	2SL 007 547-067	E9 5447	2VB 998 232-201
E4 9496	1LA 993 975-037	E4 9810	2VP 008 204-101	E6 451	2VB 007 547-171	E9 5447	2VB 998 232-211
E4 9496	1LA 993 975-047	E4 9810	2VP 008 204-121	E6 451	2VD 007 547-181	E9 5447	2VB 998 232-221
E4 9496	1LA 993 975-117	E4 9810	2VP 008 204-161	E6 451	9EL 147 096-001	E9 5447	2VB 998 232-231
E4 9496	1LA 996 074-037	E4 9810	2VP 008 204-181	E6 451	9EL 147 097-001	E9 5447	2VB 998 232-241
E4 9496	1LA 996 074-047	E4 9810	2VP 008 204-201	E6 452	2SE 007 547-011	E9 5447	2VP 998 232-261
E4 9496	1LA 996 074-197	E4 9810	2VP 008 204-221	E6 452	2SE 007 547-017	E9 5447	2VP 998 232-301
E4 9496	1LA 996 074-207	E4 9810	2VP 008 204-241	E6 452	2SE 007 547-021	E9 5447	9EL 990 632-001
E4 9496	1LA 996 127-017	E4 9810	9EL 152 889-001	E6 452	2SE 007 547-027	E9 5447	9EL 990 632-011
E4 9500	2SK 008 208-051	E4 9810	9EL 152 891-001	E6 452	2SE 007 547-041	K 11103/1	1S0 001 430-011
E4 9500	2SK 008 208-061	E4 9811	2VD 008 205-011	E6 452	2SL 007 547-061	K 11103/1	9ES 012 060-011
E4 9756	1LL 010 202-071	E4 9811	2VD 008 205-021	E6 452	2SL 007 547-067	K 11580	2SA 001 647-041
E4 9758	1LJ 010 202-051	E4 9811	2VD 008 205-041	E6 452	2VB 007 547-171	K 12642	2BA 001 227-201
E4 9758	1LL 010 202-081	E4 9811	2VD 008 205-051	E6 452	2VD 007 547-181	K 12642	2BA 001 227-211
E4 9759	1LJ 010 202-061	E4 9811	2VP 008 205-031	E6 452	9EL 147 096-001	K 12642	9EL 074 484-011
E4 9761	1LL 010 202-111	E4 9811	9EL 152 884-001	E6 452	9EL 147 097-001	K 12642	9EL 074 484-031
E4 9762	1LL 010 202-121	E4 9815	1LL 223 151-031	E6 453	2SE 007 547-011	K 12749	2BA 001 236-001
E4 9787	1LE 010 198-051	E4 9815	1LL 223 151-041	E6 453	2SE 007 547-017	K 12749	9EL 085 408-001
E4 9787	1LE 010 198-061	E4 9817	1LF 010 197-031	E6 453	2SE 007 547-021	K 12753	2BA 001 244-001
E4 9792	1LB 008 461-551	E4 9817	1LF 010 197-041	E6 453	2SE 007 547-027	K 12753	9EL 085 478-001
E4 9792	1LB 008 461-751	E4 9823	2SD 964 169-331	E6 453	2VB 007 547-171	K 12793	2BA 001 248-001
E4 9793	1LB 008 461-561	E4 9823	2SD 964 169-337	E6 453	9EL 147 096-001	K 13487	8RA 003 503-001
E4 9793	1LB 008 461-761	E4 9836	2VA 341 419-011	E8 3573	1NO 354 017-011	K 13931	2XW 002 897-041
E4 9794	1LB 008 461-551	E4 9836	2VA 341 419-017	E8 3573	1NO 354 017-021	K 13931	2XW 002 897-051
E4 9794	1LB 008 461-751	E4 9836	2VA 341 419-021	E8 3575	1LL 354 027-051	K 13932	2XW 003 146-001
E4 9795	1LB 008 461-561	E4 9836	2VA 341 419-027	E8 3575	1LL 354 027-061	K 13949	2XW 007 146-001
E4 9795	1LB 008 461-761	E4 9836	2VA 341 419-061	E8 3575	1LL 354 027-091	K 13950	2XW 007 146-011
E4 9798	1LE 010 198-091	E4 9836	2VA 341 419-067	E8 3575	1LL 354 027-101	K 18614	2RL 007 337-057
E4 9798	1LE 010 198-101	E4 9836	2VA 341 419-111	E8 4762	1LJ 247 045-331	K 18614	9EL 859 020-001
E4 9798	1LE 010 198-151	E4 9836	2VA 341 419-117	E8 4762	1LJ 247 045-341	K 18614	9EL 859 020-101
E4 9798	1LE 010 198-161	E4 9836	2VA 341 419-147	E8 4762	1LL 247 045-371	K 18651	9EL 859 658-011
E4 9798	1LE 010 199-031	E4 9836	2VP 341 419-031	E8 4763	1LJ 247 045-331	K 18652	9EL 859 658-001
E4 9798	1LE 010 199-041	E4 9836	2VP 341 419-037	E8 4763	1LJ 247 045-341	K 18659	9EL 859 020-101
E4 980	2BA 964 255-011	E4 9836	2VP 341 419-041	E8 4763	1LL 247 045-371	K 21032	1S3 001 117-041
E4 980	2BA 964 255-031	E4 9836	2VP 341 419-047	E8 4764	1LJ 247 045-331	K 21032	9ES 015 675-001
E4 9808	2VD 008 204-051	E4 9836	2VP 341 419-121	E8 4764	1LJ 247 045-341	K 21037	1S3 001 117-041
E4 9808	2VD 008 204-071	E4 9836	2VP 341 419-127	E8 4764	1LL 247 045-381	K 21037	9ES 015 675-001
E4 9808	2VD 008 204-131	E4 9836	2VP 341 419-137	E8 4765	1LJ 247 045-331	K 21055	1X0 001 515-021
E4 9808	2VD 008 204-141	E4 9836	2VP 343 590-017	E8 4765	1LJ 247 045-341	K 21085	1S5 003 178-431
E4 9808	2VD 008 204-151	E4 9836	2VP 343 590-027	E8 4765	1LL 247 045-381	K 21090	1TA 003 570-001
E4 9808	2VD 008 204-171	E4 9836	2VP 343 590-037	E8 4816	1LG 009 901-231	K 21090	1TA 003 570-101
E4 9808	2VD 008 204-191	E4 9836	2VP 343 590-047	E8 4816	1LG 009 901-241	K 21090	1TA 122 718-001
E4 9808	2VD 008 204-211	E4 9836	2VP 343 590-057	E8 4817	1LG 009 901-231	K 21090	1TA 122 718-021
E4 9808	2VD 008 204-231	E4 9836	2VP 343 590-067	E8 4817	1LG 009 901-241	K 22609	2BA 001 263-001
E4 9808	2VD 008 204-251	E4 9836	2VP 343 590-077	E8 71-26	2SE 997 008-001	K 23237	2BE 003 018-011
E4 9808	2VD 008 205-011	E4 9836	2VP 343 590-087	E8 71-26	9EL 997 332-001	K 23246	2BE 001 278-011
E4 9808	2VD 008 205-021	E4 9837	1LD 246 044-231	E8 71-27	2SE 997 008-001	K 23246	2BE 001 278-021



Type Approval Numbers

K 23246	9EL 087 769-001
K 23256/1	2SB 001 673-002
K 23256/1	2ST 001 673-011
K 23256/1	9EL 110 928-001
K 23260/1	2SB 003 018-031
K 23260/1	2ST 003 018-061
K 23260/1	9EL 089 114-001
K 23267	2BA 001 259-611
K 23267	2BA 001 259-618
K 23267	2PF 001 259-677
K 23267	9EL 088 150-001
K 23269	2BE 001 259-061
K 23269	9EL 088 538-001
K 23270	2SB 001 259-261
K 23270	2ST 001 259-321
K 23270	9EL 088 525-001
K 23318	2SB 001 301-021
K 31420	2TF 001 259-761
K 33256	9EL 092 435-011
K 33265	2SD 001 305-021
K 33265	9EL 052 476-001
K 33375	2SD 001 306-061
K 33375	2SE 001 306-051
K 33375	9EL 104 571-031
K 33375	9EL 104 571-041
K 4106	2XS 003 168-071
K 4106	2XS 003 168-081
K 4106	2XS 003 168-131
K 43322	2SE 001 679-051
K 43322	9EL 126 294-001
K 53397	2SD 001 679-001
K 53397	2SE 001 679-051
K 53397	9EL 126 294-001
K 8649	9EL 856 415-001
K 8650	9EL 856 417-001
K 8651	9EL 856 416-001
K 8652	9EL 856 418-001
K 8652	9EL 856 418-011
K 8680	9EL 857 576-021
K 8680	9EL 857 576-031
K 8687	9EL 857 801-001
K 8694	9EL 857 803-001

WE WILL ACCOMPANY YOU INTO THE FUTURE



The amount of Electrics and Electronics components in vehicles will continue to grow. Product excellence, absolute reliability and Diagnostics know-how will be the indicators of your work. In order to stay ahead, Hella will continue to be your competent partner.

The reasons:

- The innovative spirit of our 6,000 Electronics specialists
- Proven quality of our production
- Maintenance of over one million component parts applications
- Product availability of more than 95%

Let's look forward to the future.

HELLA KGaA Hueck & Co.

Rixbecker Straße 75, 59552 Lippstadt /Germany
Tel. +49 2941 38-0, Fax +49 2941 38-71 33
info@hella.com, www.hella.com



Hella KGaA Hueck & Co.

Rixbecker Straße 75
59552 Lippstadt/Germany
Tel.: +49(0)2941/38-0
Fax: +49(0)2941/38-7133
Internet: www.hella.com

© HELLA KGaA Hueck & Co., Lippstadt
9Z2 999 130-924 WI/05.11/1.0
Printed in Germany