

WERKZEUG-KATALOG

2016



K16/DE/XX/0 Gültig bis 31.12.2016

10 JAHRE



Inhalt	ab Seite
Werkstattwagen und Werkbank inkl. Sortiment	18
Werkstattwagen und Werkbank, einzeln	30
Werkstattwagen-Zubehör	33
Werkbank / Werkzeugschrank	39
Weichschaum-Einlagen	40
Werkzeugkoffer	50
Steckschlüssel-Systeme	52
Schraubenschlüssel	81
Schraubendreher und Bits	89
Zangen	95
VDE-Werkzeuge	106
Handwerkzeuge	110
Mess-Werkzeuge	118
Schneiden / Sägen / Zerspanen	119
Lampen / Leuchten	124
Drehmoment-Werkzeuge	126
Druckluft	130
Tragehilfen	133
Diagnose / Batterie / Elektrik	133
Motor / Kühlung / Klima	138
Öldienst	160
SAC-Kupplung	168
Bremsen	169
Räder / Reifen	180
Karosserie	194
KFZ-Fahrwerk	197

Erklärung der Piktogramme

	KFZ Werkzeug
	LKW Werkzeug
	Betriebsanleitung / Anwendungshinweis
	Zentralverriegelung
	Gewicht Werkstattwagen
	Traglast Werkstattwagen
	Teiligkeit
	Zähne
	Drehwinkel
	Bohrungen
	Wellen
	Magnet
	Leuchtdauer
	Ladezeit
	Gewicht
	Batterietyp
	Akkustisches Signal
	Betriebsdruck
	Vibration
	U/min
	Lautstärke
	Max. Lösemoment
	Doppelhammerschlagwerk
	Kupplungsstecker-Nennweite
	Batterietyp
	Prüfgeräte
	SUV/Van
	Landmaschinen
	Industrie
	QR-Code
	Anwendungsvideo
	Schlauchlänge
	Ölinhalt
	Hydraulische Nutzung
	Mechanische Nutzung

Erklärung Antriebssymbole

	Für Schlitz-Schrauben
	Für Kreuzschlitz-Schrauben (PH)
	Für Pozidriv-Schrauben (PZ)
	Für Innensechskant-Schrauben
	Für Außensechskant-Schrauben
	Für Innen TORX ® Schrauben
	Für Tamper Resistant TORX ® Schrauben (Innen TORX ® Schrauben mit Zapfenführung)
	Für Außen TORX ® Schrauben
	Für Innenvielzahn-Schrauben (XZN)
	Für Innenkeilprofil-Schrauben
	Für Polydrive-Schrauben
	Für Innen-5-Stern-Schrauben mit Zapfen
	Für Tri-Wing® Schrauben
	Nenngröße 6,3 mm
	Nenngröße 10 mm
	Nenngröße 12,5 mm
	Nenngröße 20 mm
	Nenngröße 25 mm
	Innen-Vierkant
	Außen-Vierkant
	Innen-Sechskant
	Außen-Sechskant
	EN/IEC 60900:2004



Alphabetisches Stichwort-Verzeichnis

A	
Abbrechklingen.....	120
ABS-Reibahlen-Satz.....	169
Adapter.....	56, 60, 69, 73, 151, 156
Adapter für Bremswartungs-Systeme	170
Adapter-Einlage.....	40
Adapter-Satz.....	80, 166
Aluminium-Ratschen-Ringschlüssel	88
Aluminium-Ratschen-Ringschlüssel-Satz	88
Anhängekasten.....	33
Arretierwerkzeug für Nockenwellen-Antriebsräder	139
Aufsatzkoffer für Werkstattwagen V1901 / Unterschrank für Werkbank V2531, leer	34
Ausblas-Pistole	131
Auspuff-Ratschenrohrschneider.....	123
Auswuchtgewicht-Zange.....	190
Autolichtprüfer.....	134

B	
Bandmaß	118
Batterie-Tragegriff.....	133
Batterietester	133
Batterietester und Ladesystem-Prüfgerät mit Thermodrucker.....	134
Bit Box	94
Bit-Adapter.....	56, 60
Bit-Box mit Fingerratsche	94
Bit-Schraubendreher.....	55, 94
Blindniet-Zange	104
Bördelgerät	174
Bördelgerät-Satz.....	175
Brecheisen	113
Bremskolben-Rückstell Werkzeug-Satz.....	179
Bremseleitungs-Schlüssel-Satz	177
Bremssattel-Bürste	176
Bremssattel-Feile	176
Bremsscheiben-Dickenmesser.....	172
Bürsten-Satz.....	114

C	
Crimpzangen-Satz.....	103
Cutter-Messer	120

D	
Digital Multimeter.....	135
Digitaler Messschieber.....	118
Dokumentenhalter.....	33
Doppel-Gelenkschlüssel.....	81
Doppel-Gelenkschlüssel-Satz.....	81
Doppel-Maul-, Doppel-Ring- und Ring-Maulschlüssel-Satz	45
Doppel-Maulschlüssel.....	81
Doppel-Maulschlüssel-Satz.....	42, 81
Doppel-Ratschen-Ringschlüssel	87-88
Doppel-Ratschen-Ringschlüssel-Satz	88
Doppel-Ringschlüssel	83
Doppel-Ringschlüssel- und Doppel-Maulschlüssel-Satz	45
Doppel-Ringschlüssel-, Doppel-Maulschlüssel-, Ring-Maulschlüssel-Satz	47
Doppel-Ringschlüssel-Sortiment	83
Doppelgelenk-Zangen-Satz.....	42
Dosenhalter	33, 37
Drahtbürste mit Schaber	121
Drehmoment-Schlüssel.....	127-128
Drehwinkel-Messgerät	129
Dreikant-Feile	121
Druckkissen-Satz	196

E	
Edelstahl-Drahtbürste	121

E	
Einhand-Universalzange.....	101
Einteilungs-/ Trennblech-Sortiment.....	37
Elektronik-Schraubendreher-Satz	91
Ersatz-Spannband.....	161
Ersatz-Thermorollen-Paar	134
Ersatzbehälter für Öl-Einfüllgerät	166
Ersatzklingen	111, 120, 123
Ersatzkopf (Paar)	110
Ersatzteile für VIGOR 500, 600, 700 und 800.....	33
für VIGOR 1000 / VIGOR 1000XL	37
Erweiterung-Sortiment für SAC- Kupplungswerkzeug.....	168

F	
Fäustel	110
Feilen	121
Feilen-Satz	43
Feinzahn-Umschaltknarre.....	55, 59, 66
Feinzahn-Umschaltknarren-Satz	80
Felgenschloss-Sortiment	182-183
Fingerratsche	55
Flachmeißel.....	111
Flachrund-Zange.....	95
Flachrundzange mit Doppelgelenk.....	100
Flachstumpf-Feile	121
Flaschenwagenheber	185
Flexible Verlängerung	56
Frostschutz-Prüfer.....	152
Fühlerlehren-Satz.....	118
Führungsbolzen-Reparatur-Satz	173

G	
Gelenk-Ratschen-Ring-Maulschlüssel.....	86
Gelenk-Ratschen-Ring-Maulschlüssel-Satz.....	86
Gewinde-Reparatur-Satz	122
Gewindebohrer-Satz.....	122
Gleitgriff.....	56, 69, 73, 75
Gleitstück	69, 75
Glühkerzen-Steckschlüssel	58
Glühkerzen-Steckschlüssel-Satz	57
Grip-Zangen-Satz	43, 102
Gummihammer.....	192

H	
Haken- und Schaber-Satz	112
Halbrund-Feile	121
Halblech-Paar für Unterschrank VIGOR 1000.....	38
Hammer-, Meißel- und Durchtreiber-Satz.....	43
Hammer-, Meißel-, Splinttreiber - Satz	48
Hammer-, Zangen- und Meißel-Satz.....	44
Hammer-, Zangen-, Schraubendreher-Satz.....	47
Hammer-, Zangen-, Splinttreiber-Satz.....	49
Handpumpe mit Manometer	150
Hebeleisen-Satz.....	113
HSS Stufenbohrer-Satz.....	122
Hydraulik Rangier-Wagenheber.....	186-187

I	
Injektorschacht-Reinigungs-Satz.....	153
Innensechskant Schraubendreher-Einsatz.....	67
Innensechskant Schraubendreher-Einsatz-Sortiment	44, 63
Innensechskant- Werkzeug-Satz.....	41
Innenvielzahn Schraubendreher-Einsatz (XZN) Sortiment.....	44, 62
Innenvielzahn-Einsätze (XZN) und Spiralbohrer-Satz	41
Inspektions-Werkzeug für Brems- und Kraftstoffleitungen.....	176



J	
Japanische Zugsäge	119
Japanspachtel Satz	117

K	
Kabelnriegelungs-Werkzeugsatz	137
Keilrippenriemen Werkzeug-Sortiment	140
Kettenbürste (360°) zur Reinigung von Motorrad-/ Fahrrad-/ Antriebsketten	114
Klebegewicht-Entferner	190
Klebegewicht-Entferner-Satz	190
Kleine Handbügel-Säge	118
Klemmschrauben-Demontage-Werkzeug-Satz für Vierlenker-Achse VAG	199
Klemmstück mit Kunststoff-Schonbacken (universal)	198
Kniekissen	116
Körner	111
Kombizange	95
Kombizange mit Doppelgelenk	100
Kompressions- und Druckverlustfester Satz	159
Kraft-Steckschlüssel-Einsatz	70
Kraft-Steckschlüssel-Einsatz-Sortiment	65
Krallengreifer	115
Kreuzmeißel	111
Kreuzschlitz-Schraubendreher	89
Kreuzschlüssel	180
Kühlersystem-Diagnose-Satz	150-151
Kühlsystem-Schraubadapter	150
Kugelgelenk-Abzieher, hydraulisch	198
Kunststoff-Haube	37
Kunststoff-Nietzange	105
Kunststoff-Reparatur-Satz	194
Kunststoff-Schonhammer	110

L	
Ladegerät (12 V) für LED-Knicklampe V2316	124
LED-Knicklampe	124
LED-Verlängerung	69
Leitungsschlüssel-Satz	178
Lenkrad-Einstellwaage	192
Lichtmaschinen Steckschlüssel-Satz	154
Lkw-Achsölwanne	163
Lösehebel	113
Lösehebel-Satz	112
LötKolben	116

M	
Magnetheber	115
Manometer für Turbosystem-Abdrücker-Satz	155
Manuelle Vakuum- und Druckpumpe	167
Manueller Bremsenlüfter-Satz	171
MasterKey Bau	111
MasterKey Elektro	111
Maul-Gripzange	102
Mehrzweckwanne mit Rollen, extraflach	163
Mess-, Schneidwerkzeug-, Zangen-Satz	46
Messer-, Schaber- und Pinzetten-Satz	43
Messing-Drahtbürste	121
Messkabel-Satz	136
Metall-Spannband-Satz	193
Motoreinstell Werkzeug-Satz	141-149
Multi-Tool 14-in-1	101
Multiprofil Steckschlüssel-Satz	53, 61
Multiprofil-Steckschlüssel-Einsatz	54, 66

N	
Nockenwellen Anpassung VAG 1.8L, 2.0L TFSI-Motoren	146
Nockenwellen-Arretierwerkzeug	140

N	
Nockenwellen-Arretierwerkzeug VAG	149

Ö	
Öl-Einfüllgerät mit Adapter-Satz	166
Ölablass-Schlauch	164
Ölfilterbandschlüssel für den Pkw-Bereich	161
Ölfilterkralle für Pkw	161
Ölfilterschlüssel-Satz	161
Ölmesstab AUDI	160
Ölmesstäbe-Satz MERCEDES-BENZ	160

P	
Papierrollenhalter	37
Pinzetten-Satz	115
Pneumatischer Bremskolben-Rückstellwerkzeug-Satz	179
Präzisions-Ölspritze	115
Profi Kartuschenpresse	116
Profi Universalmesser	120
Profiliefenmesser	191

R	
Radio Demontage-Satz	132
Ratschen-Ring-Maulschlüssel und 15° gekröpfte Ring-Maulschlüssel-Satz	45
Ratschen-Ring-Maulschlüssel-Satz	84-85
Ratschen-Ring-Maulschlüssel-Satz	42
Ratschen-Rohrschneider	123
Refraktometer	152
Reifen- und Montagehebel	189
Reifen- und Montagehebel mit Kunststoff-Belag	189
Reifendrucktester	191
Reparatur-Gewindehülse	122
Reparatur-Satz	55, 59, 66
RIBE Schraubendreher- Einsatz-Sortiment	44
RIBE Schraubendreher-Einsatz	68
RIBE Schraubendreher-Einsatz-Sortiment	63
Ring-Maul-, Doppelring-Maulschlüssel-Satz für VIGOR 1000 XL	49
Ring-Maulschlüssel	82
Ring-Maulschlüssel-, Doppel-Ringschlüssel-Satz	48
Ring-Maulschlüssel-, Verlängerung-, Montiereisen-Satz	48
Ring-Maulschlüssel-Satz	42, 82
Rohrbieger	177
Rohrleitungstopper-Satz	138
Rohrschneider	123
Rund-Feile	121

S	
SAC-Kupplungswerkzeug-Satz	168
Sägebogen	118
Saugheber	196
Schaber	111
Schaber für Glasoberflächen	111
Schaber- und Hakensatz inkl. Autolichtprüfer	43
Schaber-Satz	112
Scheibenwischerarm-Abzieher-Satz	195
Schiebestück/Adapter	60
Schlagschrauber	130
Schlagschrauber-Steckschlüssel-Satz	181
Schlauchklemmen-Satz	138
Schlitz-Schraubendreher	89
Schlitz-Schraubendreher mit Schlagkappe	89
Schlosser-Hammer	110
Schraubendreher	92
Schraubendreher- Einsatz-Sortiment	44
Schraubendreher- und Schaber-Satz	46
Schraubendreher- und Zangen-Satz	46



Alphabetisches Stichwort-Verzeichnis

S

Schraubendreher-Einsatz	54–55, 59
Schraubendreher-Einsatz-Sortiment	64
Schraubendreher-Satz	42, 47–48, 89
für VIGOR 1000 XL	49
mit Bit-Box	44
mit Schlagkappe	42, 89
Schraubenschlüssel-Sortiment	45
Schwenkbare Verlängerung	56, 60, 69
Sechskant T-Griff Schraubendreher	93
Sechskant-Steckschlüssel-Schraubendreher	91
Sechskant-Steckschlüssel-Schraubendreher-Satz	91
Sechskant-T-Griff Schraubendreher-Satz	93
Seitenschneider	95
Selbstschlagender Körner	111
Sicherungsring-Zange	97
Spannratsche	193
Spannrollenschlüssel VAG	149
Spannungsprüfer	108
Spezial Kraft-Steckschlüssel MERCEDES-BENZ	180
Spezial-Ausdreh-Steckschlüssel-Einsätze	191
Spezial-Bit	163
Spiralbohrer- und Schaber-Satz	41
Spiralbohrer-Satz	122
Spiralnutenausdreher-Einsatz	71
Spiralnutenausdreher-Einsatz-Sortiment	64
Splint-Austreiber	111
Spurstangen-Gelenk-Werkzeug	197
Stahl-Drahtbürste	121
Steckgriff	55
Steckschlüssel- Werkzeug-Satz	41, 44
Steckschlüssel-Einsatz	54, 58, 66, 73
Steckschlüssel-Einsatz- Sortiment, lang	41
Steckschlüssel-Einsatz-, Winkelschraubendreher, -Ratschen-Ring-Maulschlüssel-Satz	48
Steckschlüssel-Einsatz-Sortiment	46
Steckschlüssel-Satz	47, 52, 57, 61, 72, 76–78
Steckschlüssel-Werkzeug-Satz	45–46, 49
Stirnlampe	125
Stoßdämpfer-Montagewerkzeug-Satz	198
Sub Maker Quadro 10-in-1	110

T

T-Griff Drehmoment-Schraubendreher	126
T-Griff-Umschaltknarre	55
Taschenlampe, 1 Watt	125
TORX® Schraubendreher	90
TORX® Schraubendreher-Einsatz	55, 59, 68–69
TORX® Schraubendreher-Einsatz-Sortiment	44, 62
TORX® Schraubendreher-Satz	42, 90
TORX® Steckschlüssel-Einsatz	54, 58, 66
TORX® Steckschlüssel-Satz	79
TORX® T-Griff Schraubendreher	93
TORX® T-Griff Schraubendreher-Satz	93
TORX® und Innenvielzahn- Einsatz-Sortiment (XZN)	41
TORX® und Sechskant T-Griff-Schraubendreher- Satz	47
TORX® und Sechskant-T-Griff-Schraubendreher-Satz	45
TORX® Werkzeug-Satz	41
Tragehilfe	133
Trennblech-Satz	33
Trennblech-Sortiment	37
Turbo-System Abdrücker-Satz	155–157

U

Umschaltknarre	73, 75
Universal Ölfilter-Spannschlüssel	162
Universal Werkzeugkoffer	51
Universal-Messer	120
Universal-Nietzange für Blindnieten und Nietmuttern	104
Universal-Schere	119

U

Universal-Werkzeugkoffer	50
Universalgelenk	56, 60, 69
Universalzange	101
Unterstellbock-Satz 6 t	188
Unterstellböcke 3 t	188

V

Vakuum- und Druckpumpen-Satz	158
Vakuum-Befüllereinheit	150
Vakuumpumpe	164–165
VDE-Abisolierzange	109
VDE-Flachrund-Zange	109
VDE-Kombizange	109
VDE-Kreuzschlitz-Schraubendreher	108
VDE-Rundzange	108
VDE-Schlitz-Schraubendreher	108
VDE-Schraubendreher-Satz	43, 108
VDE-Seitenschneider	109
VDE-Steckschlüssel-Satz	43, 106
VDE-Umschaltknarre	107
VDE-Verlängerung	107
VDE-Zangen-Satz	43
Verlängerung	56, 60, 69, 73, 75
Vierkant-Feile	121
VIGOR 500	29–30
VIGOR 600	27–28, 31
VIGOR 700	24–26, 31
VIGOR 800	23, 32
VIGOR 1000	18–20, 34–35, 38–39
VIGOR 1000 Aufsatzschrank für Werkbank, mit 2 Roll-Jalousien, leer	38
VIGOR 1000 Werkbank-System, komplett	39
VIGOR 1000 XL	21–22, 36

W

Wasserwaage	117
Weichschaum-Einlage (2K), mit Leerfach	43
Weichschaum-Einlage, leer	41–49
Weichschaumeinlage ohne Ausfräsung	40
Werkbank mit Sortiment	23
Werkbank, leer	32
Werkstattwagen inkl. Aufsatzkoffer, leer	35
Werkstattwagen mit Sortiment	19–20, 22, 24–29
Werkstattwagen mit Sortiment für VW und AUDI	21
Werkstattwagen mit Sortiment und Aufsatzkoffer	18
Werkstattwagen XL, leer	36
Werkstattwagen, leer	30–31, 34
Werkzeug-Satz für Reifendruck-Kontroll-Systeme (RDKS)	184
Werkzeughaken-Sätze für Aufsatzschrank	38
Werkzeugkoffer	50
Winkelschraubendreher	92
Winkelschraubendreher-Satz	92

Z

Zange für Sicherungsringe	98–99
Zangen-, Hammer- und Meißel-Satz	47
Zangen-Satz	42, 46, 48
Zangen-Satz für Sicherungsringe	96
Zubehör	38
Zündkerzen-Einsatz	58, 66



Nummernverzeichnis

VIGOR-No.	Seite	VIGOR-No.	Seite	VIGOR-No.	Seite	VIGOR-No.	Seite	VIGOR-No.	Seite	VIGOR-No.	Seite	VIGOR-No.	Seite	VIGOR-No.	Seite
V1008	85	V1301	113	V1481	81	V1651	42	V1718	98	V1908	37	V2022	44	V2109	69
V1009	85	V1304	119	V1482	81	V1652	41	V1719	98	V1909	37	V2027	108	V2110	69
V1010	85	V1345	120	V1483	26	V1653	41	V1722	134	V1911	125	V2028	108	V2111	73
V1020	66	V1364	88	V1487	25	V1654	41	V1723	112	V1915	114	V2029	108	V2112	160
V1021	85	V1367	116	V1506	45	V1655	42	V1724	118	V1917	62	V2030	108	V2113	67
V1022	85	V1368	111	V1507	44	V1656	44	V1728	175	V1918	62	V2032	44	V2114	60
V1023	85	V1369	112	V1509	41	V1657	190	V1729	43	V1919	63	V2033	44	V2115	60
V1025	85	V1372	111	V1510	45	V1658	41	V1741	115	V1921	114	V2059	67	V2116	60
V1026	85	V1378	191	V1511	44	V1660	41	V1743	45	V1923	134	V2060	67	V2117	60
V1027	85	V1382	30	V1512	41	V1661	41	V1745	43	V1963	150	V2061	108	V2118	60
V1028	85	V1386	33	V1513	45	V1662	42	V1746	43	V1970	35	V2062	108	V2119	58
V1029	85	V1387	33	V1514	43	V1663	42	V1747	45	V1972	47	V2063	108	V2120	58
V1030	85	V1389	33	V1517	45	V1664	42	V1748	46	V1973	46	V2064	108	V2121	67
V1031	85	V1390	33	V1518	44	V1665	44	V1749	23	V1974	47	V2065	67	V2122	67
V1032	55	V1391	33	V1519	41	V1667	41	V1750	33	V1975	47	V2066	67	V2123	67
V1038	55	V1396	30	V1520	45	V1668	42	V1751	33	V1976	54	V2067	67	V2124	67
V1039	80	V1397	30	V1521	44	V1669	81	V1752	33	V1977	54	V2068	67	V2126	67
V1040	82	V1398	30	V1522	41	V1671	81	V1754	33	V1978	54	V2069	67	V2128	67
V1041	82	V1399	30	V1523	43	V1672	81	V1756	33	V1979	54	V2070	67	V2129	67
V1042	82	V1400	88	V1524	83	V1673	82	V1757	133	V1980	54	V2071	60	V2132	67
V1043	82	V1409	93	V1525	45	V1674	82	V1764	115	V1981	54	V2072	67	V2133	67
V1044	82	V1410	93	V1527	31	V1676	82	V1781	79	V1982	54	V2073	67	V2134	67
V1045	82	V1411	88	V1542	33	V1677	82	V1782	177, 175	V1983	54	V2074	67	V2135	67
V1047	82	V1412	88	V1547	33	V1678	82	V1783	111	V1984	54	V2075	67	V2136	55
V1048	82	V1414	88	V1549	33	V1679	82	V1785	101	V1985	54	V2076	67	V2137	67
V1049	82	V1415	88	V1550	33	V1680	82	V1787	121	V1986	54	V2077	67	V2138	55
V1050	82	V1416	88	V1552	33	V1682	41	V1788	121	V1987	54	V2078	67	V2139	55
V1051	82	V1417	88	V1571	192	V1683	42	V1789	121	V1988	66	V2079	67	V2140	55
V1052	82	V1418	88	V1578	31	V1684	83	V1790	121	V1989	66	V2080	67	V2141	55
V1053	82	V1419	88	V1579	33	V1685	83	V1801	121	V1990	66	V2081	67	V2142	55
V1097	94	V1420	88	V1581	31	V1686	83	V1802	102	V1991	66	V2082	67	V2143	58
V1131	69	V1423	191	V1582	26	V1687	83	V1803	102	V1992	66	V2083	67	V2144	58
V1135	110	V1424	88	V1584	191	V1688	83	V1804	102	V1993	66	V2084	67	V2145	58
V1138	108	V1425	50	V1586	152	V1689	83	V1805	177	V1994	66	V2085	67	V2146	58
V1139	92	V1426	101	V1610	33	V1690	83	V1806	43	V1995	66	V2086	67	V2149	59
V1181	92	V1429	113	V1616	95	V1691	83	V1807	43	V1996	66	V2087	67	V2151	68
V1203	122	V1430	88	V1617	95	V1692	83	V1808	102	V1997	66	V2088	67	V2152	68
V1208	92	V1435	133	V1620	27	V1693	83	V1809	119	V1998	66	V2089	67	V2153	68
V1209	92	V1438	115	V1622	33	V1694	83	V1811	43	V1999	66	V2090	67	V2154	68
V1212	110	V1441	88	V1625	33	V1695	83	V1841	177	V2000	66	V2091	67	V2155	68
V1213	111	V1442	88	V1626	33	V1698	89	V1842	177	V2001	66	V2092	67	V2156	68
V1214	111	V1443	88	V1627	31	V1699	89	V1843	177	V2002	66	V2094	67	V2157	68
V1215	111	V1444	88	V1628	31	V1700	89	V1844	177	V2003	66	V2095	67	V2158	68
V1216	111	V1445	88	V1629	33	V1701	89	V1871	46	V2004	66	V2096	67	V2159	68
V1217	111	V1446	120	V1630	33	V1702	89	V1893	115	V2006	47	V2097	67	V2160	68
V1218	111	V1461	81	V1631	33	V1703	89	V1897	53	V2007	46	V2098	67	V2161	68
V1219	111	V1471	81	V1632	33	V1704	89	V1898	61	V2008	47	V2099	67	V2162	68
V1220	111	V1472	81	V1633	33	V1705	32	V1899	44	V2009	47	V2100	67	V2163	68
V1221	111	V1473	81	V1634	33	V1706	78	V1900	44	V2014	56	V2101	67	V2165	68
V1222	111	V1474	81	V1635	33	V1707	122	V1901	34	V2015	43	V2102	67	V2167	68
V1251	31	V1475	81	V1636	33	V1711	179	V1902	34	V2016	58	V2103	67	V2168	68
V1252	30	V1476	81	V1637	89	V1713	118	V1903	37	V2017	58	V2104	67	V2169	68
V1281	161	V1477	81	V1644	33	V1714	118	V1904	37	V2018	58	V2105	67	V2170	68
V1282	161	V1478	81	V1645	33	V1715	118	V1905	37	V2019	58	V2106	67	V2171	68
V1283	112	V1479	81	V1646	33	V1716	98	V1906	37	V2020	58	V2107	67	V2172	68
V1293	80	V1480	81	V1649	42	V1717	98	V1907	37	V2021	44	V2108	60	V2173	68



Nummern- / Seiten-Verzeichnis

Nummernverzeichnis

VIGOR-No.	Seite	VIGOR-No.	Seite	VIGOR-No.	Seite	VIGOR-No.	Seite	VIGOR-No.	Seite	VIGOR-No.	Seite	VIGOR-No.	Seite	VIGOR-No.	Seite
V2174	68	V2235	192	V2304	59	V2404	64	V2460	61	V2521	161	V2595	55	V2681	163
V2175	68	V2236	193	V2305	57	V2405	71	V2461	77	V2522	181	V2596	55	V2682	133
V2176	68	V2237	40	V2306	168	V2406	71	V2462	37	V2523	195	V2597	54	V2683	197
V2177	68	V2238	40	V2308	168	V2407	71	V2463	38	V2531	38	V2598	66	V2684	197
V2178	68	V2239	43	V2311	58	V2408	71	V2464	49-50	V2532	38	V2599	66	V2685	196
V2179	68	V2240	43	V2312	58	V2409	71	V2465	66	V2533	54	V2600	66	V2687	79
V2180	68	V2249	176	V2313	58	V2410	71	V2466	175	V2534	54	V2603	66	V2699	54, 184
V2181	68	V2250	176	V2314	58	V2411	176	V2467	175	V2535	54	V2604	39	V2700	54, 184
V2182	68	V2253	122	V2315	58	V2412	95	V2471	181	V2536	54	V2605	41	V2701	54
V2183	68	V2256	73	V2316	124	V2413	54	V2472	181	V2537	54	V2606	41	V2702	164
V2184	68	V2257	181	V2317	73	V2414	52	V2473	181	V2538	54	V2607	41	V2704	153
V2185	54	V2258	44	V2318	72	V2415	54	V2474	181	V2539	54	V2611	41	V2705	87
V2186	54	V2259	44	V2319	73	V2416	54	V2475	181	V2540	175	V2612	41	V2711	31
V2187	54	V2261	58	V2320	73	V2417	54	V2477	188	V2542	50	V2613	58	V2712	28
V2188	54	V2262	58	V2321	73	V2418	54	V2478	185	V2551	175	V2614	58	V2722	54
V2189	54	V2263	58	V2322	73	V2419	54	V2479	185	V2552	175	V2615	58	V2723	54
V2193	59	V2264	58	V2323	73	V2420	54	V2480	187	V2553	175	V2616	60	V2724	58
V2194	59	V2265	58	V2324	73	V2421	54	V2481	186	V2554	175	V2621	117	V2725	58
V2195	59	V2266	58	V2325	73	V2422	54	V2482	93	V2555	175	V2622	117	V2726	58
V2196	66	V2267	58	V2326	73	V2423	54	V2483	93	V2556	175	V2623	117	V2727	58
V2197	66	V2268	58	V2327	73	V2424	54	V2484	93	V2558	175	V2624	123	V2728	58
V2200	69	V2269	58	V2328	73	V2425	54	V2485	93	V2559	175	V2625	123	V2729	58
V2201	63	V2270	58	V2329	73	V2426	54	V2486	93	V2560	41	V2626	123, 175	V2730	66
V2202	68	V2271	58	V2330	73	V2427	54	V2487	112	V2561	66	V2627	120	V2731	66
V2203	68	V2272	58	V2331	73	V2428	54	V2488	112	V2562	66	V2628	109	V2732	66
V2204	68	V2273	58	V2332	73	V2429	54	V2489	93	V2563	66	V2629	109	V2733	66
V2205	68	V2274	58	V2333	73	V2430	54	V2490	93	V2564	66	V2630	109	V2734	66
V2206	68	V2275	58	V2334	73	V2431	54	V2491	112	V2565	66	V2631	186	V2735	66
V2207	68	V2276	58	V2335	73	V2432	54	V2492	112	V2566	66	V2632	186	V2736	29
V2208	68	V2277	58	V2336	73	V2433	54	V2493	112	V2567	66	V2633	187	V2737	57
V2209	68	V2278	58	V2337	73	V2434	54	V2494	112	V2568	66	V2634	187	V2738	58
V2210	68	V2279	59	V2338	116	V2435	54	V2495	112	V2569	66	V2637	187	V2739	58
V2211	68	V2280	59	V2347	124	V2436	54	V2496	64	V2570	66	V2638	187	V2741	58
V2212	68	V2281	59	V2363	45	V2437	54	V2497	93	V2571	66	V2639	186	V2742	58
V2213	68	V2282	59	V2364	45	V2438	54	V2498	93	V2572	66	V2640	186	V2743	58
V2214	68	V2283	59	V2372	30	V2439	55	V2499	103	V2573	69	V2641	108	V2744	58
V2215	68	V2284	59	V2373	44	V2440	55	V2501	93	V2574	66	V2643	109	V2761	188
V2216	68	V2285	59	V2374	45	V2441	55	V2502	93	V2575	69	V2644	101	V2762	188
V2217	68	V2286	59	V2375	45	V2442	55	V2503	93	V2576	69	V2645	160	V2781	100
V2218	68	V2287	59	V2376	46	V2443	55	V2504	93	V2577	69	V2647	69	V2782	100
V2219	68	V2288	59	V2377	46	V2444	55	V2505	93	V2578	66	V2648	188	V2783	100
V2220	68	V2289	59	V2378	44	V2445	55	V2506	93	V2579	66	V2649	187	V2788	104
V2221	68	V2290	59	V2379	29	V2446	55	V2507	93	V2580	66	V2651	121	V2789	176
V2222	68	V2291	59	V2391	193	V2447	55	V2508	112	V2581	66	V2652	121	V2790	118
V2223	68	V2292	59	V2392	193	V2448	92	V2509	112	V2582	66	V2653	121	V2791	99
V2224	68	V2293	59	V2393	37	V2449	92	V2510	138	V2584	66	V2654	121	V2792	99
V2225	68	V2294	59	V2394	122	V2450	92	V2511	161	V2585	66	V2655	131	V2793	99
V2226	68	V2295	59	V2395	122	V2451	92	V2512	190	V2586	66	V2662	110	V2794	99
V2227	68	V2296	59	V2396	122	V2452	56	V2513	190	V2587	66	V2663	110	V2795	129
V2228	68	V2297	59	V2397	37	V2453	56, 184	V2514	190	V2588	66	V2664	110	V2804	86
V2229	68	V2298	59	V2398	37	V2454	56	V2515	190	V2589	66	V2665	110	V2805	86
V2230	68	V2299	59	V2399	37	V2455	56	V2516	190	V2590	66	V2666	131	V2806	86
V2231	68	V2300	59	V2400	49-50	V2456	56	V2517	38	V2591	66	V2667	69	V2807	86
V2232	68	V2301	59	V2401	71	V2457	56	V2518	38	V2592	66	V2669	125	V2808	86
V2233	68	V2302	59	V2402	71	V2458	55	V2519	38	V2593	54	V2671	44	V2809	86
V2234	192	V2303	59	V2403	71	V2459	152	V2520	38	V2594	55	V2672	44	V2810	86



Nummernverzeichnis

VIGOR-No.	Seite	VIGOR-No.	Seite	VIGOR-No.	Seite	VIGOR-No.	Seite	VIGOR-No.	Seite	VIGOR-No.	Seite	VIGOR-No.	Seite	VIGOR-No.	Seite
V2811	86	V3372	75	V3605	46	V3729	150	V4204	81	V4312	56	V4407	70	V4561	18
V2812	86	V3373	75	V3606	46	V3730	178	V4205	81	V4313	56	V4408	65	V4579	40
V2813	86	V3374	75	V3607	87	V3734	52	V4206	81	V4314	60	V4411	171	V4580	40
V2814	86	V3375	75	V3608	87	V3735	104	V4207	81	V4315	60	V4412	167	V4584	48
V2815	84	V3376	75	V3609	89	V3737	71	V4208	81	V4316	60	V4413	162	V4585	49
V2817	86	V3377	75	V3610	89	V3738	102	V4209	81	V4317	69	V4414	162	V4586	49
V2818	86	V3378	75	V3613	89	V3739	102	V4212	55	V4318	69	V4416	174	V4587	47
V2819	86	V3379	75	V3615	189	V3741	64	V4213	122	V4319	69	V4418	90	V4588	48
V2820	85	V3380	75	V3616	42	V3742	71	V4214	122	V4322	132	V4419	90	V4589	48
V2821	84	V3381	138	V3621	42	V3743	71	V4215	122	V4324	135	V4420	90	V4590	48
V2822	84	V3382	42	V3635	85	V3744	71	V4217	53	V4325	158	V4421	90	V4631	40
V2823	84	V3383	43	V3636	85	V3745	71	V4219	20	V4326	136	V4422	90	V4632	40
V2824	84	V3384	42	V3637	187	V3746	71	V4221	91	V4331	157	V4423	148		
V2825	84	V3385	43	V3638	187	V3747	71	V4222	91	V4341	139	V4424	146		
V2826	84	V3387	24	V3639	187	V3748	134	V4223	91	V4345	70	V4425	51		
V2827	84	V3391	90	V3640	187	V3760	179	V4224	91	V4346	145	V4427	97		
V2828	84	V3392	90	V3643	43	V3771	140	V4225	91	V4347	149	V4428	97		
V2829	84	V3393	90	V3644	43	V3863	198	V4227	111	V4348	149	V4429	97		
V2830	84	V3394	42	V3645	42	V3864	122	V4228	111	V4365	183	V4430	97		
V2831	84	V3395	42	V3646	42	V3898	127	V4230	47	V4366	182	V4431	184		
V2832	84	V3396	42	V3647	43	V3899	128	V4231	47	V4367	182	V4431-1	126, 184		
V2833	84	V3397	42	V3648	43	V4111	37	V4233	155	V4369	164	V4431-2	126, 184		
V2834	94	V3427	55, 94	V3651	56	V4112	37	V4234	110	V4371	147	V4431-3	184		
V2835	154	V3441	128	V3652	60	V4113	166	V4235	110	V4372	145	V4431-4	184		
V2837	46	V3451	123	V3653	130	V4114	166	V4236	110	V4373	146	V4431-5	184		
V2838	46	V3541	110	V3661	198	V4115	166	V4239	47	V4374	147	V4431-6	184		
V2941	55	V3550	166	V3671	194	V4122	37	V4240	47	V4375	148	V4441	96		
V3081	80	V3551	194	V3672	194	V4126	199	V4241	110	V4376	70	V4442	96		
V3228	169	V3562	89	V3673	194	V4127	173	V4248	199	V4377	70	V4451	137		
V3277	76	V3563	189	V3674	194	V4130	46	V4249	199	V4378	70	V4461	159		
V3278	74	V3564	189	V3675	194	V4153	195	V4250	199	V4379	70	V4462	70		
V3280	75	V3571	140	V3676	194	V4154	195	V4257	150	V4380	70	V4463	70		
V3306	163	V3572	153	V3677	194	V4155	195	V4258	150	V4381	170	V4471	151		
V3308	198	V3573	153	V3679	166	V4156	195	V4262	173	V4383	166	V4472	82		
V3309	123	V3574	153	V3681	166	V4157	195	V4274	120	V4384	166	V4473	82		
V3330	107	V3575	153	V3682	166	V4158	195	V4275	120	V4385	166	V4481	36		
V3331	107	V3576	153	V3683	166	V4159	195	V4277	116	V4386	70	V4481-1	37		
V3332	107	V3577	153	V3684	166	V4160	195	V4278	117	V4387	70	V4484	163		
V3333	107	V3578	153	V3685	166	V4161	195	V4279	117	V4388	70	V4497	21		
V3334	107	V3579	153	V3686	166	V4162	195	V4280	132	V4389	70	V4501	48		
V3335	107	V3580	153	V3687	166	V4163	195	V4282	144	V4390	70	V4503	48		
V3336	107	V3584	59	V3688	166	V4164	195	V4282-1	149	V4391	70	V4505	48		
V3337	107	V3585	55	V3689	166	V4165	195	V4282-9	149	V4392	70	V4507	48		
V3338	107	V3587	66	V3690	166	V4188	46	V4282-19	149	V4394	70	V4508	48		
V3339	107	V3591	153	V3691	166	V4192	155	V4283	142	V4395	70	V4510	48		
V3340	107	V3592	153	V3693	169	V4193	196	V4284	143	V4396	70	V4511	48		
V3341	107	V3593	153	V3694	169	V4194	81	V4285	141	V4397	65	V4512	48		
V3342	107	V3594	153	V3695	169	V4195	180	V4291	70	V4398	69	V4514	47		
V3343	106	V3596	151	V3696	169	V4196	105	V4303	91	V4399	172	V4517	49		
V3344	107	V3597	89	V3697	169	V4197	82	V4304	156	V4400	194	V4518	49		
V3366	90	V3598	89	V3698	169	V4198	82	V4305	156	V4401	70	V4519	49		
V3367	90	V3599	89	V3699	169	V4199	91	V4306	156	V4402	70	V4521	49		
V3368	90	V3600	89	V3703	178	V4200	91	V4308	120	V4403	70	V4523	49		
V3369	90	V3601	89	V3704	178	V4201	165	V4309	180	V4404	70	V4524	49		
V3370	90	V3602	89	V3705	178	V4202	150	V4310	113	V4405	70	V4542	22		
V3371	75	V3604	153	V3706	178	V4203	81	V4311	56	V4406	70	V4560	19		

V4561, EAN 4047728**045810**
VIGOR 1000
 inkl. Sortiment und Aufsatzkoffer

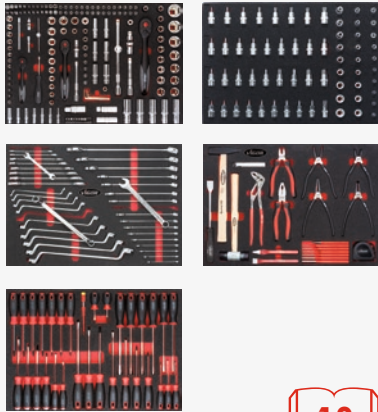

18

V4560, EAN 4047728**045605**
VIGOR 1000
 inkl. Sortiment

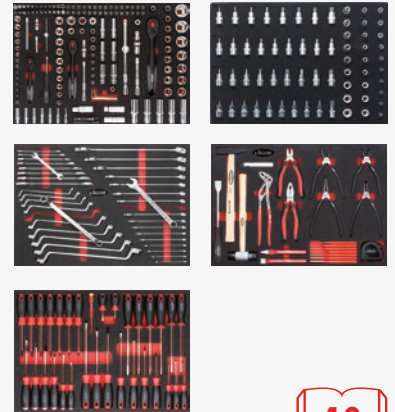

19

V4497, EAN 4047728**044974**
Vigor 1000 XL inkl.
 VW-Basissortiment

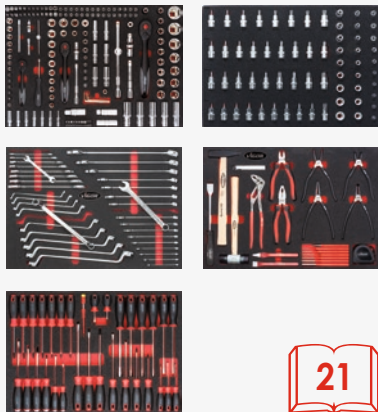

21

V4542, EAN 4047728**045421**
Vigor 1000 XL inkl. Sortimente
 374 tlg.



22

V4481, EAN 4047728**044813**
VIGOR 1000 XL
 Werkstattwagen XL, leer



36

V4481-1, EAN 4047728**041225**
 Einteilungs-/ Trennblech-Sortiment
 V1000 XL

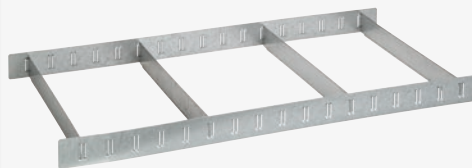

37

V4122, EAN 4047728**041225**
 Kunststoff-Haube



37

V4579, EAN 4047728**045797**
 Weichschaumeinlage ohne Ausfräsung

1/3



40

V4580, EAN 4047728**045803**
 Weichschaumeinlage ohne Ausfräsung

3/3



40

V4631, EAN 4047728**046312**
 Weichschaumeinlage ohne Ausfräsung

1/3+



40

V4632, EAN 4047728**046329**

Weichschaumeinlage ohne Ausfräsung

V1000
3/3+



40

V4587, EAN 4047728**045872**

6.3 1/4 12.9 1/2 Steckschlüssel-Satz



47

V4588, EAN 4047728**045889**

Schraubendreher-Satz



48

V4589, EAN 4047728**045896**

Steckschlüssel-Einsatz-,
Winkelschraubendreher-,
Ratschen-
Ring-Maulschlüssel-Satz

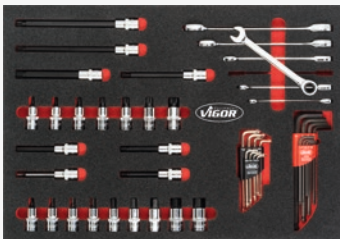

48

V4590, EAN 4047728**045902**

Ring-Maulschlüssel-, Doppel-
Ringschlüssel-Satz

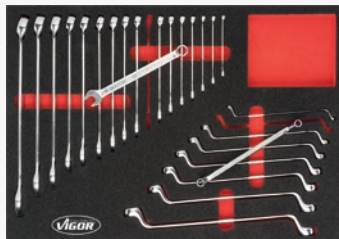

48

V4584, EAN 4047728**045841**

Ring-Maulschlüssel-, Verlängerung-,
Montiereisen-Satz

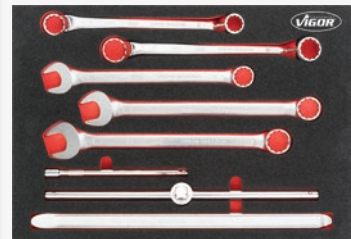

48

V4508, EAN 4047728**045087**

Zangen-Satz



48

V4511, EAN 4047728**045117**

Hammer-, Meißel-, Splintentreiber-Satz



48

V4586, EAN 4047728**045865**

Steckschlüssel-Werkzeug-Satz
für VIGOR 1000 XL



49

V4524, EAN 4047728**045247**

Ring-Maul-, Doppelring-Maulschlüssel-
Satz



49

V4518, EAN 4047728**045919**

Schraubendreher-Satz für
VIGOR 1000 XL



49

V4585, EAN 4047728**045858**

Hammer-Zangen-Splinttreiber-Satz
für VIGOR1000 XL



49

V4425, EAN 4047728**044257**
Universal Werkzeugkoffer



51

V3427, EAN 4047728**034272**
 6.3 1/4 Bit-Schraubendreher



55

V4397, EAN 4047728**043977**
 12.5 1/2 Kraft-Steckschlüssel-Einsatz-Sortiment, kurz



65

V4408, EAN 4047728**044080**
 12.5 1/2 Kraft-Steckschlüssel-Einsatz-Sortiment, lang



65

Schwenkbare Verlängerungen

- Mit kugelförmigem, konischem Außenvierkant
- Zur Betätigung von Schraubverbindungen auf engem Raum und Umgehen von Störkanten

6.3 1/4	6.3 1/4	56
10 3/8	10 3/8	60
12.5 1/2	12.5 1/2	69

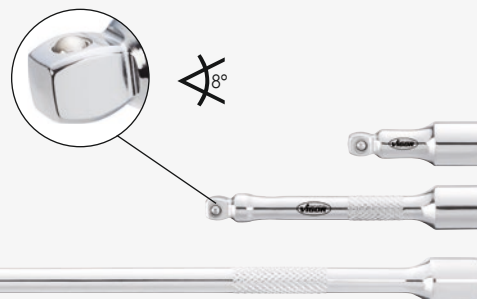

V4398, EAN 4047728**043984**
 12.5 1/2 12.5 1/2 Verlängerung 750 mm



69

V4472, EAN 4047728**044721**
 Ring-Maulschlüssel-Satz



82

V4473, EAN 4047728**044738**
 Ring-Maulschlüssel-Satz



82

V4418, EAN 4047728**044189**
 TORX® Schraubendreher-Satz



90

V4303, EAN 4047728**043038**
 Elektronik-Schraubendreher-Satz in Kunststoff-Box



91

V4441, EAN 4047728**044417**
 Zangen-Satz für Sicherungsringe, 140 mm



96

V4442, EAN 4047728**044424**
Zangen-Satz für Sicherungsringe, 180 mm



96

V4427, EAN 4047728**044271**
Sicherungsring-Zange, 140 mm



97

V4429, EAN 4047728**044295**
Sicherungsring-Zange, 140 mm



97

V4428, EAN 4047728**044288**
Sicherungsring-Zange, 140 mm



97

V4430, EAN 4047728**044301**
Sicherungsring-Zange, 140 mm



97

V4310, EAN 4047728**043106**
Lösehebel



113

V4277, EAN 4047728**042772**
Profi Kartuschenpresse



116

V4279, EAN 4047728**042796**
Japanspachtel Metall-Satz



117

V4278, EAN 4047728**042789**
Japanspachtel Kunststoff-Satz



117

V4275, EAN 4047728**042758**
Profi Universalmesser



120

V4431-1, EAN 4047728**044325**
T-Griff Drehmoment-Schraubendreher, 2 - 10 Nm



126

V4431-2, EAN 4047728**044332**
T-Griff Drehmoment-Schraubendreher, 0,2 - 2 Nm



126

V4322, EAN 4047728**043229**
Unterbodenschutz-Pistole



132

V4280, EAN 4047728**042802**
Radio Demontage-Satz



132

V4324, EAN 4047728**043243**
Digital Multimeter



135

V4326, EAN 4047728**043267**
Messkabel-Satz



136

V4451, EAN 4047728**044516**
Kabelnriegelungs-Werkzeugsatz



137

V4341, EAN 4047728**043410**
Arretierwerkzeug für Nockenwellen-
Antriebsräder



139

V4285, EAN 4047728**042857**
Motoreinstell Werkzeug-Satz RENAULT



141

V4283, EAN 4047728**042833**
Motoreinstell Werkzeug-Satz BMW



142

V4284, EAN 4047728**042840**
Motoreinstell Werkzeug-Satz BMW



143

V4282, EAN 4047728**042826**
Motoreinstell Werkzeug-Satz VAG



144

V4346, EAN 4047728**043465**
Motoreinstell Werkzeug-Satz
VAG 3 Zylinder Benzin



145

V4372, EAN 4047728**043724**
Motoreinstell Werkzeug-Satz
VAG 1.2L, 1.4L, 1.6L FSI / TSI / TFSI



145

V4373, EAN 4047728**043731**
 Motoreinstell Werkzeug-Satz
 VAG 1.6L, 2.0L TDI Common Rail



146

V4424, EAN 4047728**044240**
 Nockenwellen Anpassung VAG 1.8L,
 2.0L



146

V4374, EAN 4047728**043748**
 Motoreinstell Werkzeug-Satz
 VAG 2.0 FSI / TFSI



147

V4371, EAN 4047728**043717**
 Motoreinstell Werkzeug-Satz
 VAG 2.4L, 3.2L FSI



147

V4375, EAN 4047728**043755**
 Motoreinstell Werkzeug-Satz
 VAG 2.7L, 3.0L V6 TDI



148

V4423, EAN 4047728**044233**
 Motoreinstell Werkzeug-Satz Audi 3.0L
 V6 Benzin-Motoren



148

V4347, EAN 4047728**043472**
 Motoreinstell Werkzeug-Satz VAG



149

V4348, EAN 4047728**043489**
 Motoreinstell Werkzeug-Satz VAG 1.9L,
 2.0L PD



149

V4282-9, EAN 4047728**043496**
 Spannrollenschlüssel VAG



149

V4282-19, EAN 4047728**043502**
 Nockenwellen-Arretierwerkzeug VAG



149

V4471, EAN 4047728**044714**
 90° Adapter



151

V4304, EAN 4047728**043045**
 Turbo-System Abdrücker-Satz für Kfz



156

V4331, EAN 4047728**043311**
Turbo-System Abdrücker-Satz für Nfz



157

V4325, EAN 4047728**043250**
Vakuum- und Druckpumpen-Satz



158

V4461, EAN 4047728**044615**
Kompressions- und Druckverlusttester Satz



159

V4413, EAN 4047728**044134**
Universal Ölfilter-Spannschlüssel,
60–80 mm



162

V4414, EAN 4047728**044141**
Universal Ölfilter-Spannschlüssel,
80–115 mm



162

V4484, EAN 4047728**044844**
Spezial-Bit



163

V4369, EAN 4047728**043694**
Vakuumpumpe 350 ml



164

V4385, EAN 4047728**043854**
Öl-Einfüllgerät mit Adapter-Satz



166

V4384, EAN 4047728**043847**
Adapter für MINI Cooper



V4383, EAN 4047728**043847**
Adapter für NISSAN Juke



166

V4381, EAN 4047728**043816**
Adapter für Bremswartungs-Systeme



170

V4411, EAN 4047728**044110**
Manueller Bremsentlüfter-Satz



171

V4399, EAN 4047728**043991**
Mess-Schieber für Brems Scheibendicke



172

V4412, EAN 4047728**044127**
Manuelle Absaug- und Druckpumpe 6 L



167

V4416, EAN 4047728**044165**
Bördelgerät für \varnothing 4,75 mm



174

V4367, EAN 4047728**043670**
Felgenschloss-Sortiment,
VAG „Vielzahn-Profil“



182

V4365, EAN 4047728**043656**
Felgenschloss-Sortiment,
BMW „Kleeblatt-Profil“



183

V4366, EAN 4047728**043663**
Felgenschloss-Sortiment,
BMW „Vielzahn-Profil“



182

V4431, EAN 4047728**044318**
Werkzeug-Satz für Reifendruck-Kontroll-Systeme (RDKS)



184

V4309, EAN 4047728**043090**
Spezial Kraft-Steckschlüssel
MERCEDES-BENZ



180

V4193, EAN 4047728**041935**
Druckkissen-Satz



196



Werkstattwagen und Werkbank inkl. Sortiment



NEU

V4561, EAN 4047728045612

VIGOR 1000

344

Werkstattwagen mit Sortiment und Aufsatzkoffer



72 kg

29 kg

500 kg



25 kg

10x

8x

2x

569 x 398 x 75 mm

569 x 398 x 154 mm

**Neues
Sortiment**

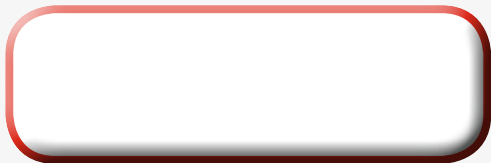

V4188

Schublade 1



V2837

Schublade 2

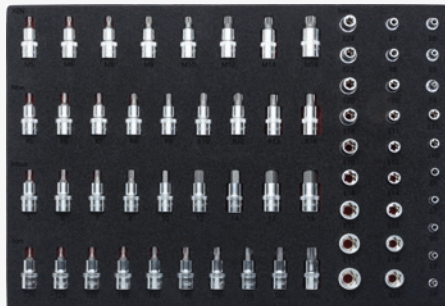

V4230

Schublade 3

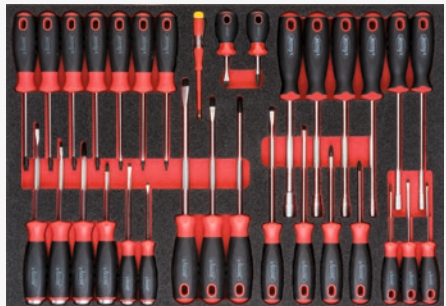

V2008

Schublade 4

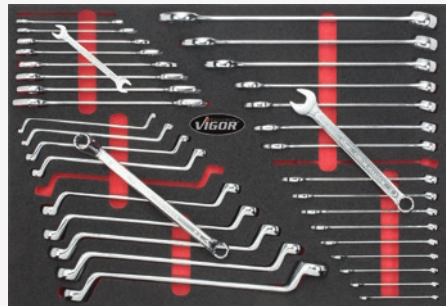

V2009

Schublade 5



Werkstattwagen und Werkbank inkl. Sortiment



NEU

V4560, EAN 4047728045605

VIGOR 1000

344

Werkstattwagen mit Sortiment



RAL 9005

H 1000 x B 723 x T 459 mm

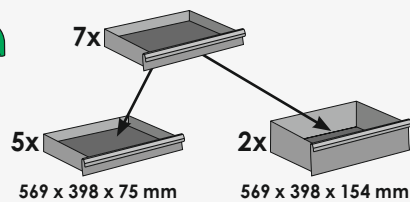
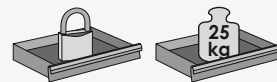
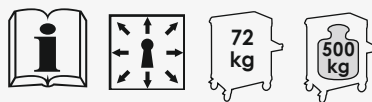

Neues Sortiment

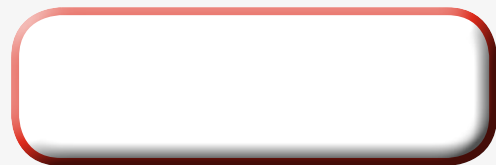

V4188

V2837

V4230

Schublade 1

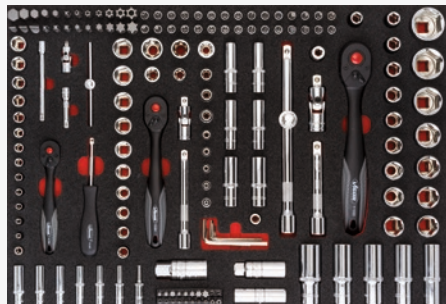

Schublade 2



Schublade 3

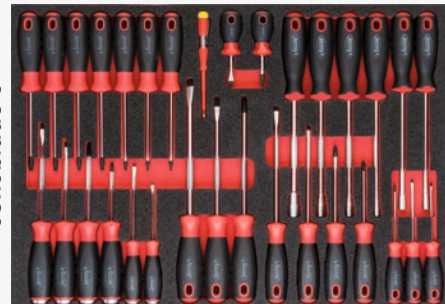

V2008

V2009

Schublade 4



Schublade 5





Werkstattwagen und Werkbank inkl. Sortiment

V4219, EAN 4047728042192

VIGOR 1000

262

Werkstattwagen mit Sortiment



RAL 9005
H 1000 x B 723 x T 459 mm

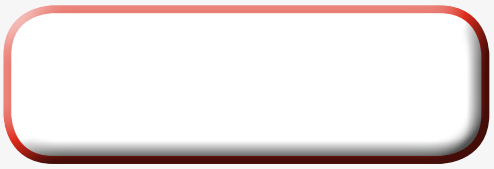
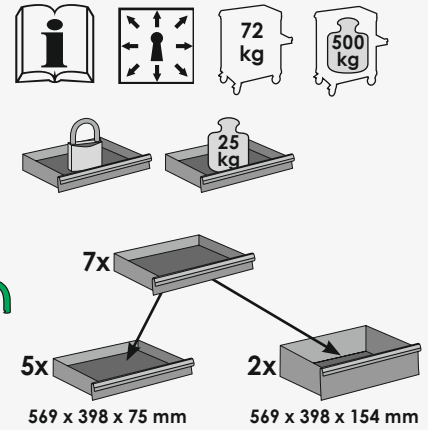

V4188

Schublade 1



V4239

Schublade 2



V2008

Schublade 3

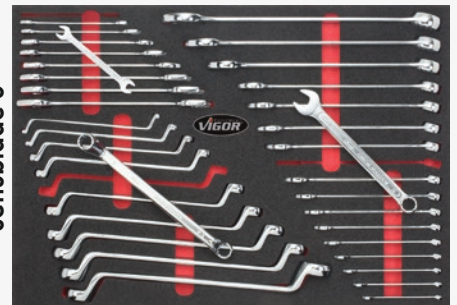

ROBUST STARK GUT



Werkstattswagen und Werkbank inkl. Sortiment



V4497, EAN 4047728044974

VIGOR 1000 XL

Werkstattwagen mit Sortiment für VW und AUDI

NEU

254

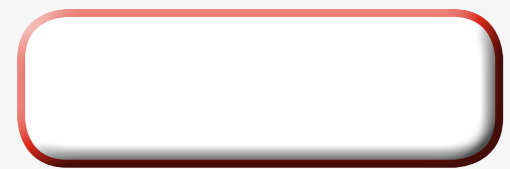
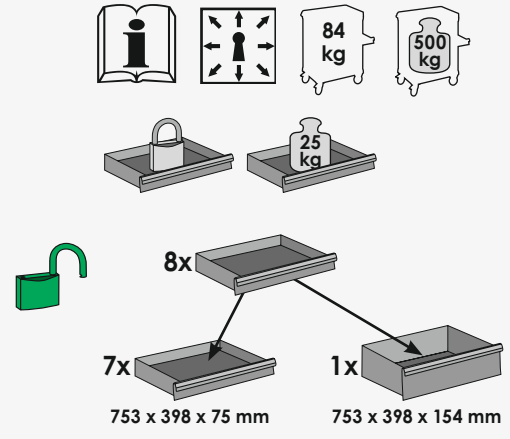

RAL 9005
H 1000 x B 907 x T 481 mm

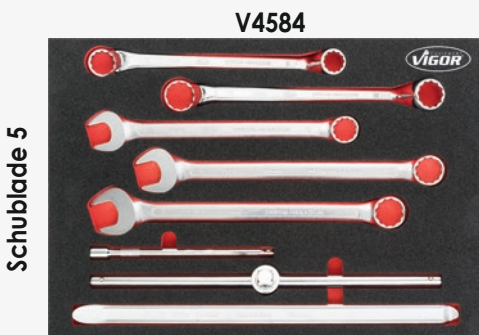
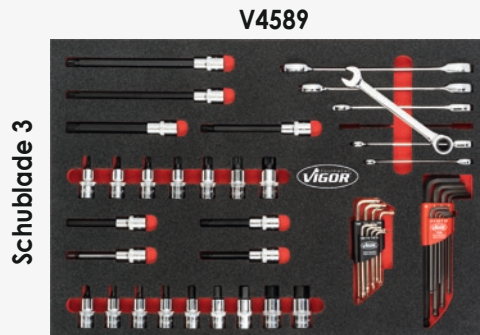



Werkstattwagen und Werkbank inkl. Sortiment

V4542, EAN 4047728045421

VIGOR 1000 XL

Werkstattwagen mit Sortiment



374



RAL 9005

H 1000 x B 907 x T 481 mm



8x

7x

1x

753 x 398 x 75 mm

753 x 398 x 154 mm

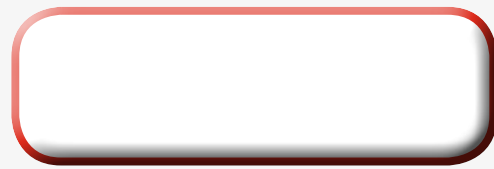

V4586

Schublade 1



V4524

Schublade 2



V4518

Schublade 3



V4585

Schublade 4



Werkstattswagen und Werkbank inkl. Sortiment



V1749, EAN 4047728017497

VIGOR 800

Werkbank mit Sortiment

347

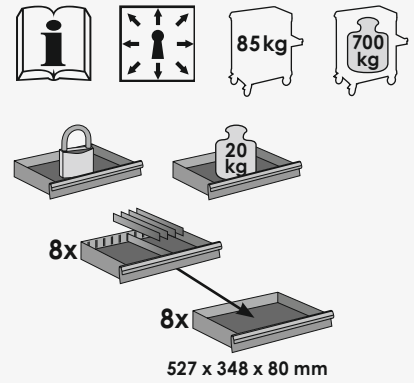

**Werkbank
Made in Germany!**

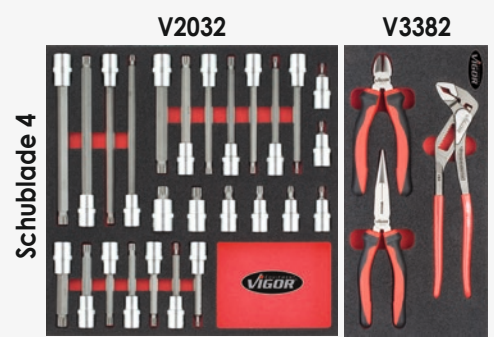
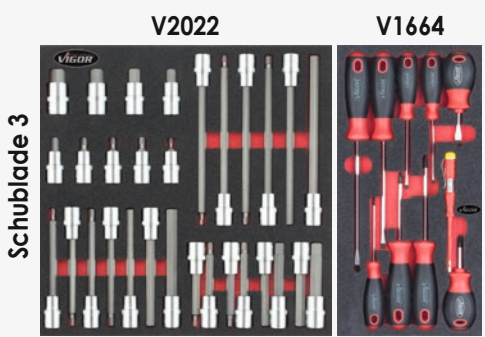
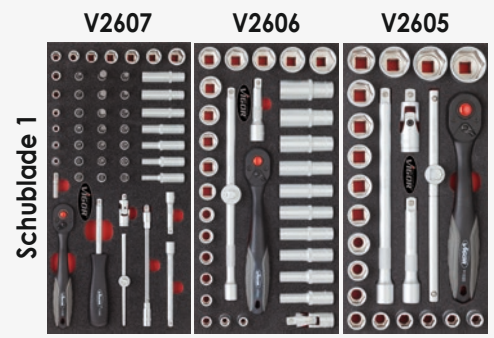



Werkstattwagen und Werkbank inkl. Sortiment

V3387, EAN 4047728033879

VIGOR 700

Werkstattwagen mit Sortiment

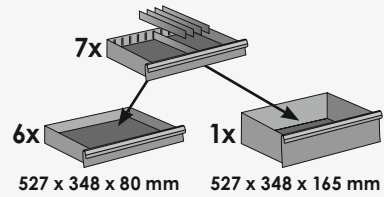
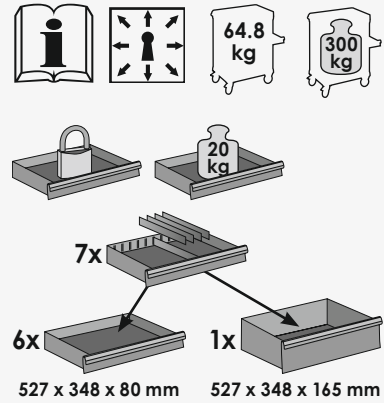

RAL 3000

H 913x B 778x T 496 mm

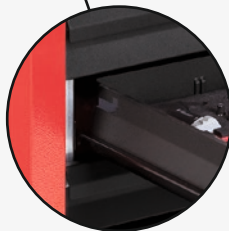
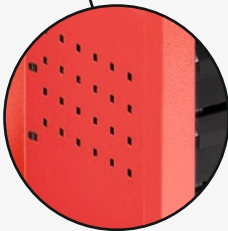

100% Auszug



**Werkstattwagen
Made in Germany!**

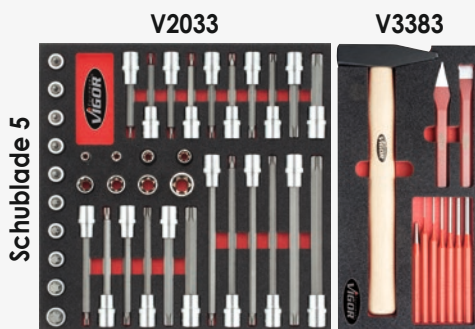
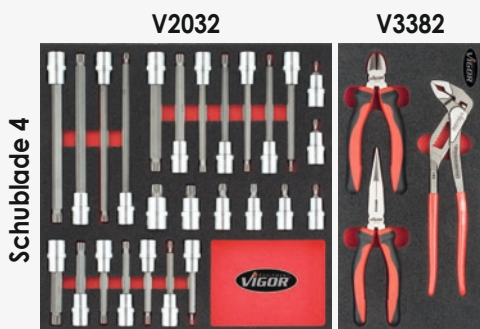
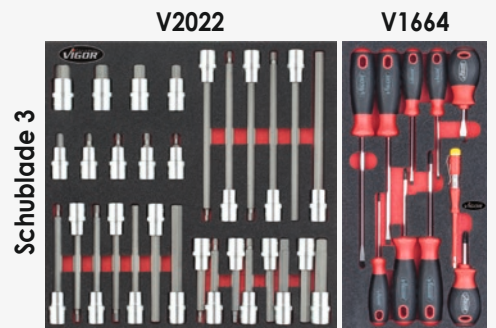
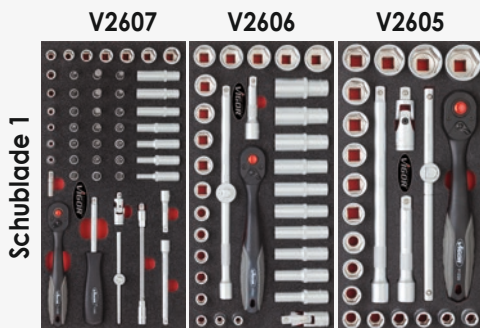
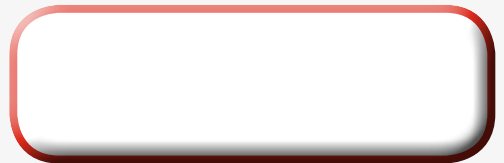

Werkstattwagen und Werkbank inkl. Sortiment



V1487, EAN 4047728014878

VIGOR 700

Werkstattwagen mit Sortiment

309

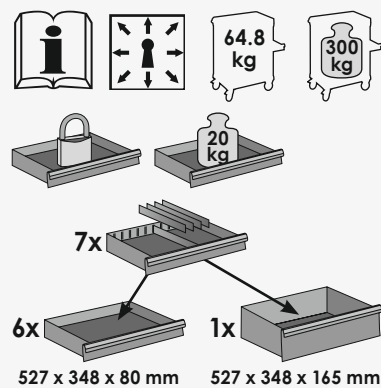

**Werkstattwagen
Made in Germany!**

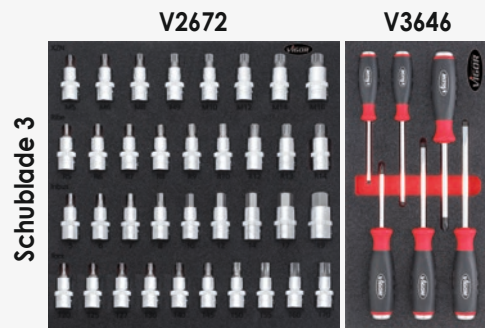
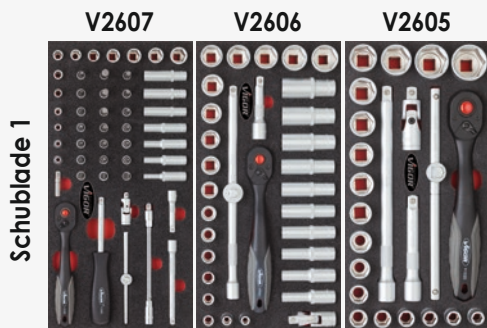
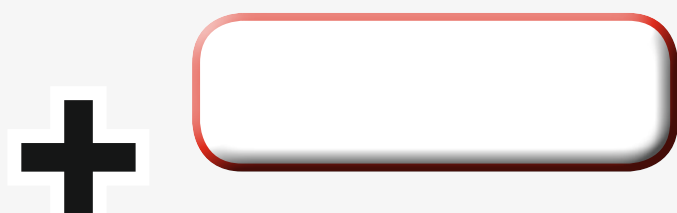



Werkstattwagen und Werkbank inkl. Sortiment

V1483, EAN 4047728014830

VIGOR 700

206

Werkstattwagen mit Sortiment

VIGOR No.	RAL	Farbe	EAN 4047728+
V1483	3000		014830
V1582	7004		015820

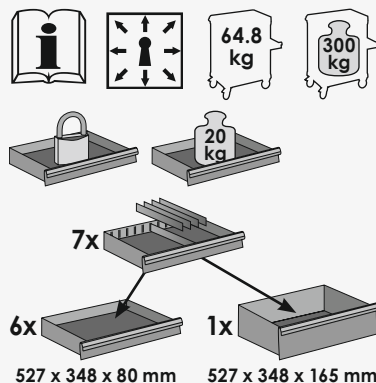

**Werkstattwagen
Made in Germany!**

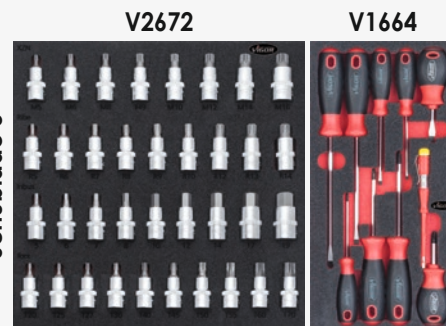
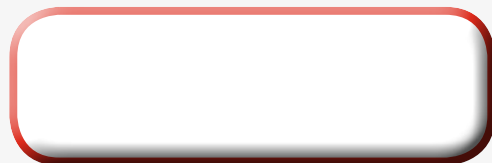

Werkstattwagen und Werkbank inkl. Sortiment



V1620, EAN 4047728016209

VIGOR 600

206

Werkstattwagen mit Sortiment

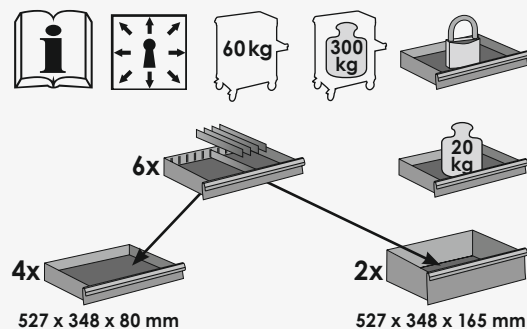

**Werkstattwagen
Made in Germany!**

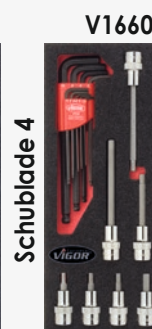



Werkstattwagen und Werkbank inkl. Sortiment

V2712, EAN 4047728027120

VIGOR 600

198

Werkstattwagen mit Sortiment

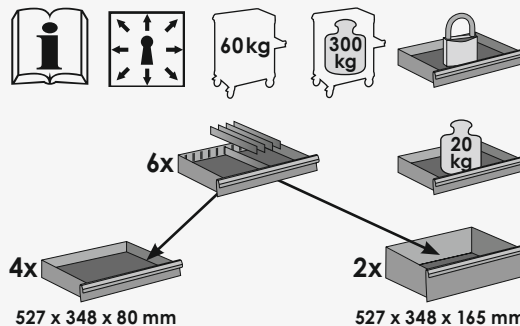

RAL 9005

H 913 x B 778 x T 496 mm

100% Auszug

**Werkstattwagen
Made in Germany!**

Black Edition II



V2378



Schublade 1

V2375

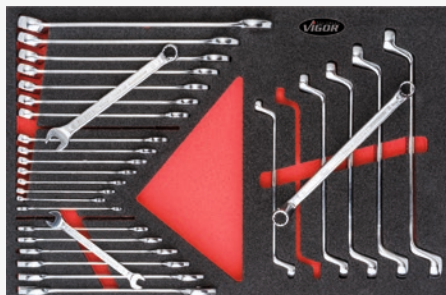

Schublade 2

V2376



Schublade 3

V2672

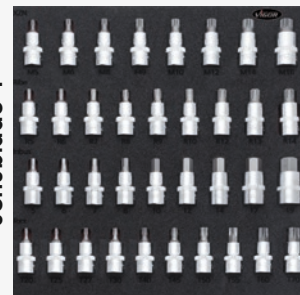

Schublade 4

V2239



Werkstattswagen und Werkbank inkl. Sortiment



V2379, EAN 4047728023795

VIGOR 500

162

Werkstattwagen mit Sortiment

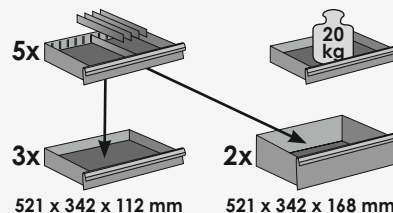

VIGOR No.	RAL	Farbe	EAN 4047728+
V2379	9005	Black	023795
V2736	5007	Blue	027366



RAL 9005

H 930 x B 700 x T 400 mm

Black Edition



**Werkstattwagen
Made in Germany!**

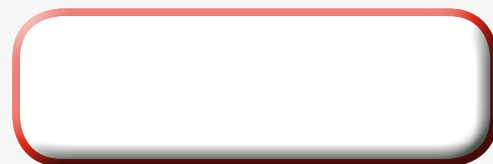



H 930 x B 700 x T 400 mm

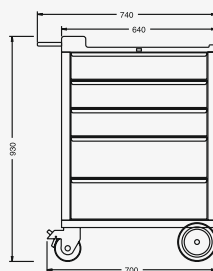

V1252, EAN 4047728012522

VIGOR 500

Werkstattwagen, leer

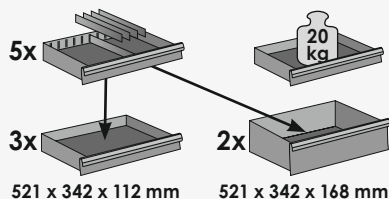
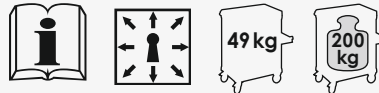

VIGOR No.	RAL	Farbe	EAN 4047728+
V1252	7004		012522
V1382	3000		013826
V1396	5007		013963
V2372	9005		023726



H 930 x B 700 x T 400 mm

V1399, EAN 4047728013994

VIGOR 500

Werkstattwagen, leer

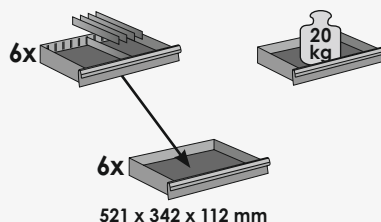

VIGOR No.	RAL	Farbe	EAN 4047728+
V1399	7004		013994
V1397	5007		013970
V1398	3000		013987



H 913x B 778x T 496 mm

V1627, EAN 4047728016278

VIGOR 600



Werkstattwagen, leer

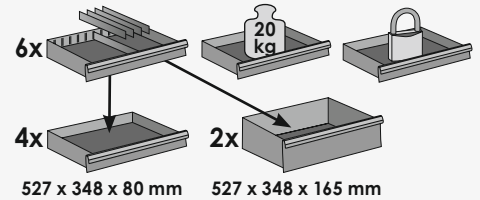

VIGOR No.	RAL	Farbe	EAN 4047728+
V1251	7004		012515
V1627	3000		016278
V1628	5007		016285
V2711	9005		027113



H 913x B 778x T 496 mm

V1581, EAN 4047728015813

VIGOR 700



Werkstattwagen, leer

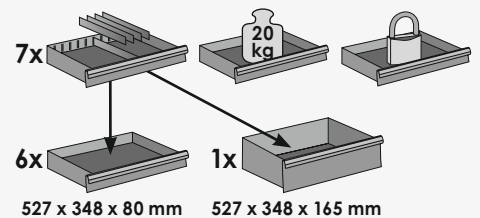

VIGOR No.	RAL	Farbe	EAN 4047728+
V1527	3000		015271
V1578	5007		015783
V1581	7004		015813

Lieferung ohne abgebildetes Werkzeug und Zubehör (auf Anfrage erhältlich)

V1705, EAN 4047728017053

VIGOR 800

Werkbank, leer

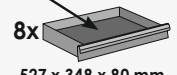
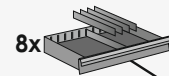

527 x 348 x 80 mm





Zubehör für ViGOR 500 / 600 / 700 / 800

Für ViGOR 500

2 Anhängerkästen, klein

• Verpackt zu je 2 Stück

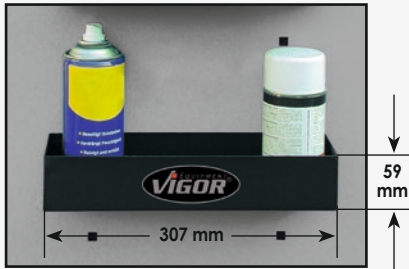

V1386,
EAN 4047728013864



Anhängerkästen, groß

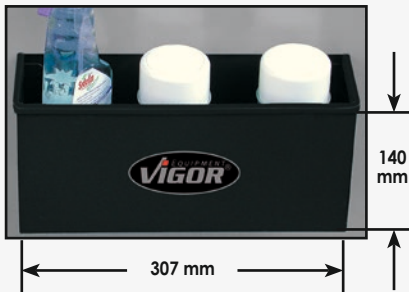

V1387,
EAN 4047728013871



Für ViGOR 600, 700, 800

Dosenhalter

• Für 3 Dosen

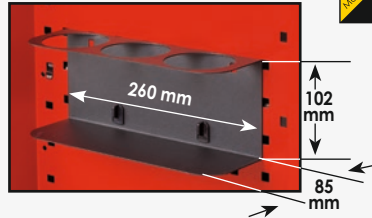

V1644,
EAN 4047728016445



Dokumentenhalter

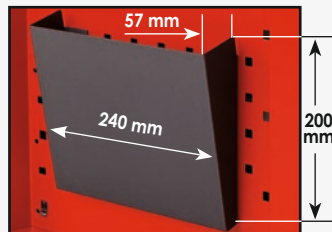

V1645,
EAN 4047728016452



Anhängerkästen, groß

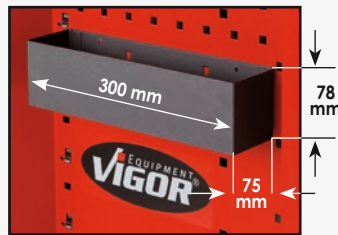

V1646,
EAN 4047728016469



Für ViGOR 500, 600, 700, 800

Anti-Rutschmatte

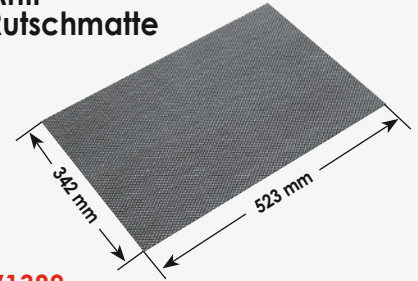

V1389,
EAN 4047728013895



Trennblech-Satz

• Verpackt zu je 5 Stück

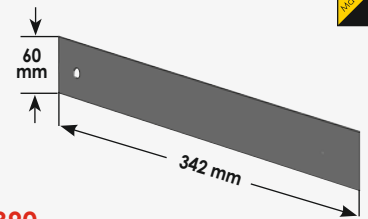

V1390,
EAN 4047728013901

(= 5 Trennbleche)



Trennblech-Satz

• Verpackt zu je 5 Stück

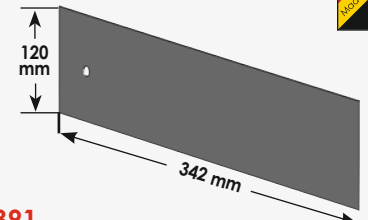

V1391,
EAN 4047728013918

(= 5 Trennbleche)



Ersatzteile für ViGOR 500, 600, 700 und 800

VIGOR No.	Bezeichnung	Passend für ViGOR	EAN 4047728+
V1625	Kunststoff-Haube	500	016254
V1626	Fahrgriff	500	016261
V1552	Führungsschiene (Paar)	500	015523
V1542	Schublade, flach	500	015424
V1547	Schublade, hoch	500	015479
V1550	Lenkrolle ohne Feststeller	500	015509
V1549	Lenkrolle mit Feststeller	500	015493
V1610	Scheibenrad	500	016100
V1622	Traverse	500	016223
V1635	Kunststoff-Haube	600, 700	016353
V1634	Fahrgriff	600, 700	016346
V1632	Schublade, hoch	600, 700	016322

VIGOR No.	Bezeichnung	Passend für ViGOR	EAN 4047728+
V1630	Lenkrolle ohne Feststeller	600, 700	016308
V1629	Lenkrolle mit Feststeller	600, 700	016292
V1636	Schubladen-Einzelverriegelung	600, 700	016360
V1756	Einteilblech-Schublade, hoch	600, 700	017565
V1750	Lenkrolle	800	017503
V1751	Bockrolle	800	017510
V1752	Arbeitsplatte	800	017527
V1579	Rollenführungs-Paar	600, 700, 800	015790
V1631	Schublade, flach	600, 700, 800	016315
V1633	Schloss inkl. 2 Schlüsseln	600, 700, 800	016339
V1754	Einteilblech-Schublade, flach	600, 700, 800	017541

Lieferung ohne abgebildetes Werkzeug und Zubehör (auf Anfrage erhältlich)

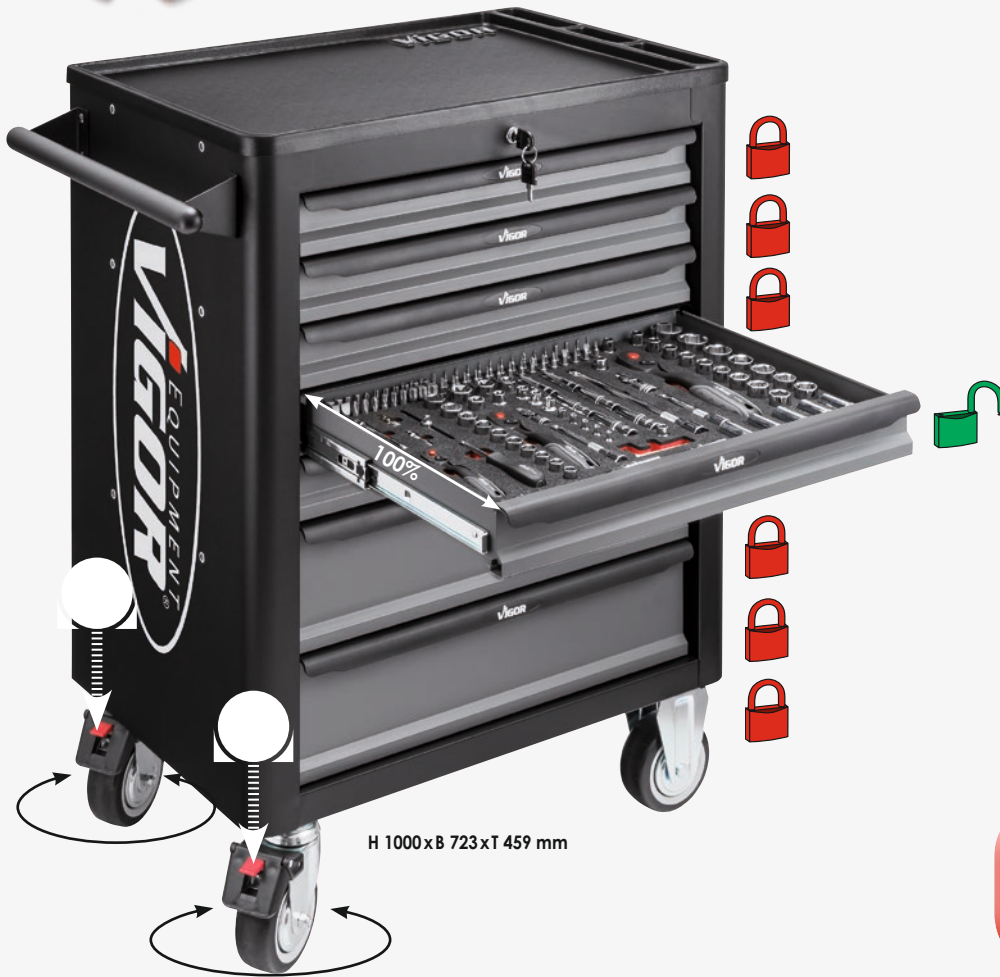

H 1000 x B 723 x T 459 mm

V1901, EAN 4047728019019

VIGOR 1000

Werkstattwagen, leer

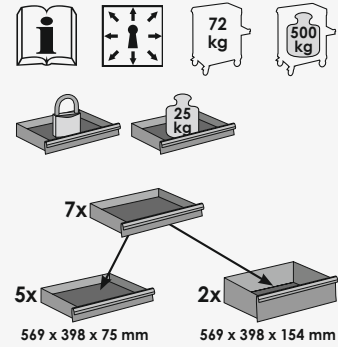

H 375 x B 723 x T 459 mm

V1902, EAN 4047728019026

VIGOR 1000

Aufsatzkoffer für Werkstattwagen V1901 /
Unterschrank für Werkbank V2531, leer

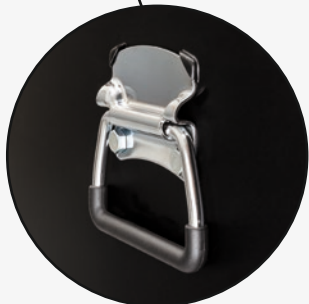
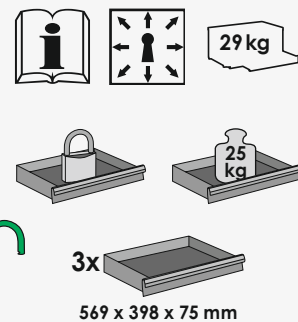

- Lieferung ohne Kunststoffhaube, siehe V1909 -





V1970, EAN 4047728019705

VIGOR 1000

Werkstattwagen inkl. Aufsatzkoffer, leer

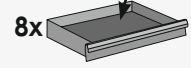
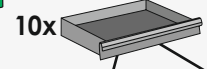

569 x 398 x 75 mm

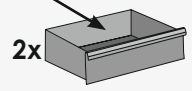

569 x 398 x 154 mm



H 1375xB 723xT 459 mm

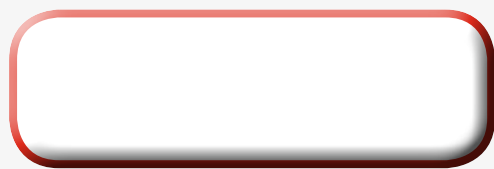
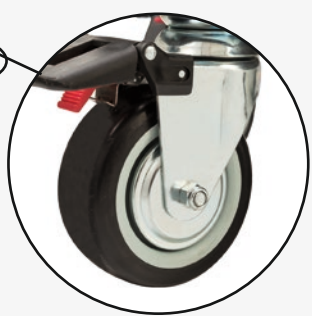



Werkstattwagen und Werkbank, einzeln

V4481, EAN 4047728044813

VIGOR 1000 XL

Werkstattwagen XL, leer

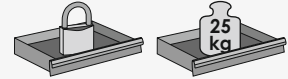

8x

7x

1x

753 x 398 x 75 mm

753 x 398 x 154 mm

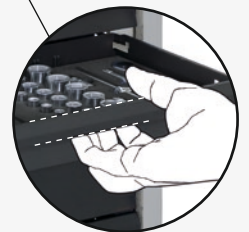

RAL 9005

H 1000 x B 907 x T 481 mm

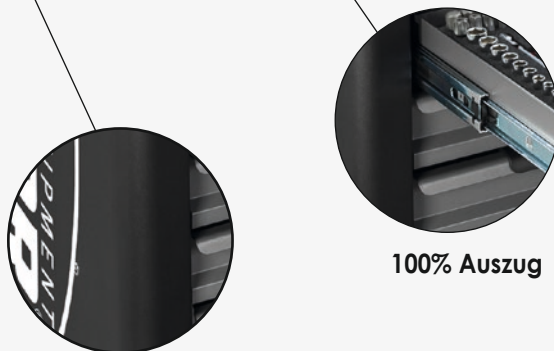

100% Auszug

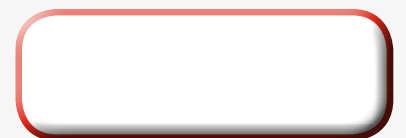

Lieferung ohne abgebildetes Werkzeug und Zubehör (auf Anfrage erhältlich)

Gültig bis 31.12.2016.



Zubehör für VIGOR 1000 / 1000 XL

V2398, EAN 4047728023986

Trennblech-Sortiment

- Verpackt zu je 5 Stück

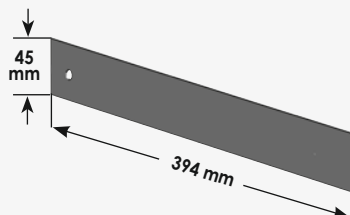

V2399, EAN 4047728023993

Einteilungs-/ Trennblech-Sortiment

- Verpackt zu 2 Einteilungsblechen und 3 Trennblechen
- Nur für VIGOR 1000

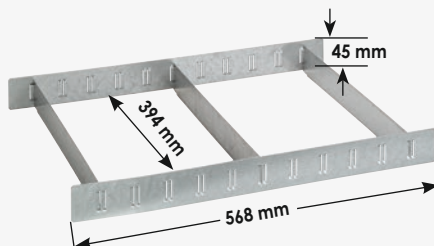

V4481-1, EAN 4047728045780

Einteilungs-/ Trennblech-Sortiment V1000 XL

- Verpackt zu 2 Einteilungsblechen und 4 Trennblechen
- Nur für VIGOR 1000 XL

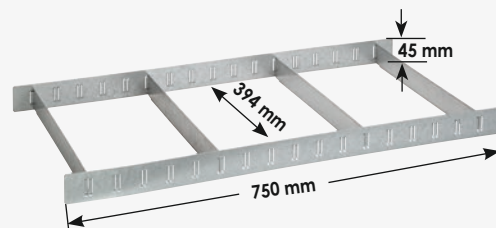

V2393, EAN 4047728023931

Dosenhalter

- Für 5 Dosen



V2397, EAN 4047728023979

Papierrollenhalter

(ohne Papierrolle)



V1909, EAN 4047728019095

Kunststoff-Haube

- Für Werkstattwagen und Aufsatzkoffer VIGOR 1000
- Nur für VIGOR 1000



Ersatzteile für VIGOR 1000 / VIGOR 1000 XL

VIGOR No.	Bezeichnung	Passend für VIGOR	EAN 4047728+
V1905	Schublade, flach	1000	019057
V1906	Schublade, hoch	1000	019064
V1903	Führungsschiene (Paar)	1000,1000 XL	019033
V1904	Verriegelungssystem	1000,1000 XL	019040
V1907	Bockrolle	1000,1000 XL	019071
V1908	Lenkrolle	1000,1000 XL	019088
V2462	Schloss, inkl. 2 Schlüsseln	1000,1000 XL	024624
V4111	Schublade, hoch	1000 XL	041119
V4112	Schublade, flach	1000 XL	041126



V4122, EAN 4047728041225

Kunststoff-Haube

- Nur für Werkstattwagen VIGOR 1000 XL





Werkzeugschrank / Zubehör für VIGOR 1000

V2532, EAN 4047728025324

VIGOR 1000

VIGOR 1000 Aufsatzschrank für Werkbank,
mit 2 Roll-Jalousien, leer

• Lieferung ohne abgebildetes Werkzeug



H 603 x B 1565 x T 203 mm

V2531, EAN 4047728025317

VIGOR 1000

VIGOR 1000 Werkbank, leer



H 800 x B 1565 x T 766 mm
Höhenverstellbar

800 - 900 mm



V2463, EAN 4047728024631

Zubehör

Halblech-Paar für Unterschrank
VIGOR 1000

• Zur Befestigung vom Unterschrank V1902
an der Werkbank V2531



Werkzeughaken-Sätze für Aufsatzschrank



VIGOR No.	l mm	EAN 4047728+
V2518	100	025188

VIGOR No.	l mm	EAN 4047728+
V2517	25	025171

VIGOR No.	l mm	EAN 4047728+
V2520	100	025201

VIGOR No.	l mm	EAN 4047728+
V2519	25	025195

Lieferung ohne abgebildetes Werkzeug und Zubehör (auf Anfrage erhältlich)

Werkbank/Werkzeugschrank



V2604, EAN 4047728026048

VIGOR 1000

VIGOR 1000 Werkbank-System, komplett

• Lieferung ohne abgebildetes Werkzeug



max.
1000
kg

H 1403 x B 1565 x T 766 mm

Lieferung ohne abgebildetes Werkzeug und Zubehör (auf Anfrage erhältlich) / Werkzeughaken-Sätze für Aufsatzschrank V2532

VIGOR 500 – 800

1/3 Modul

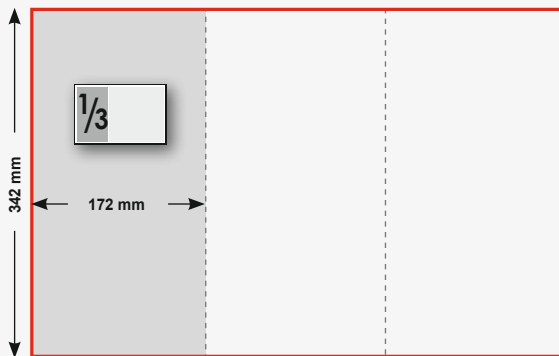

2/3 Modul

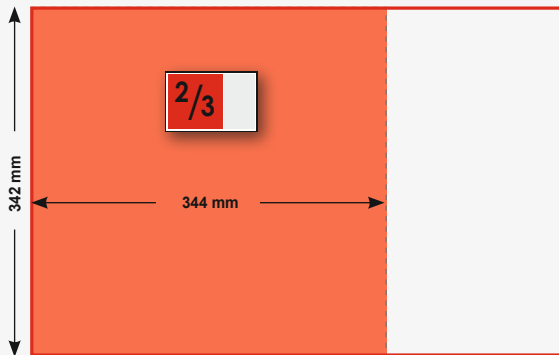

3/3 Modul

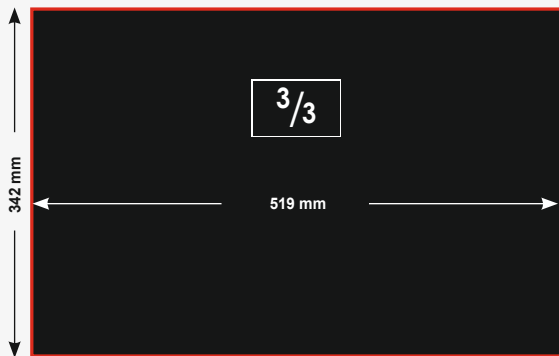

VIGOR 1000

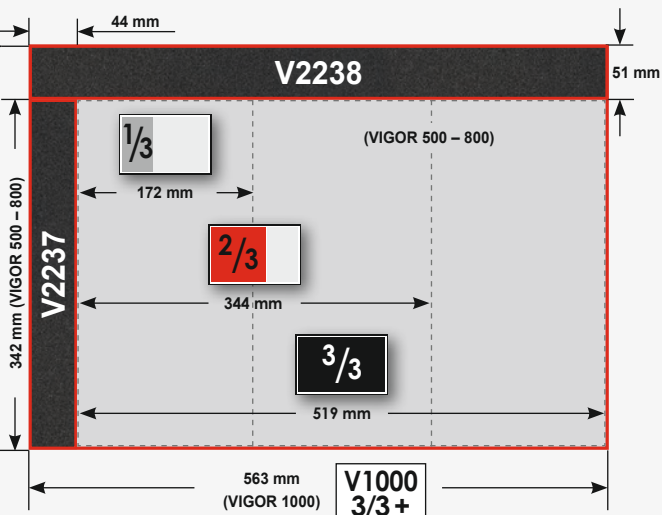

VIGOR 1000 XL

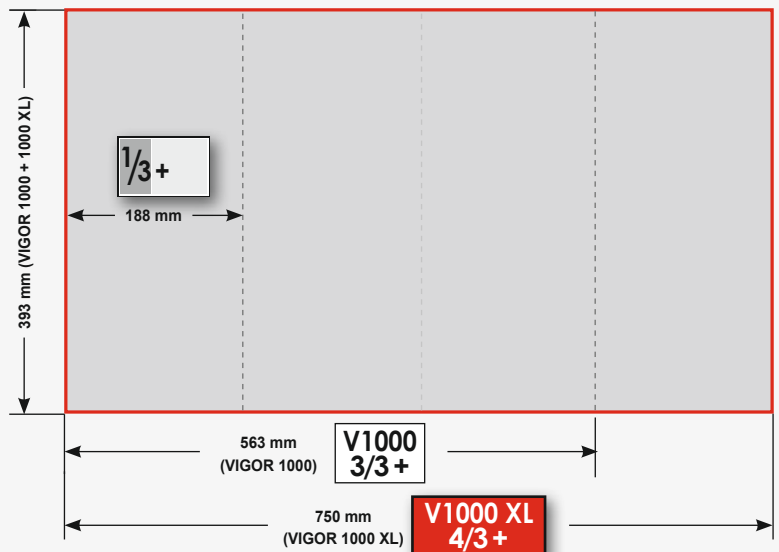

V4579, EAN 4047728**045797**
Weichschaumeinlage ohne Ausfräsung

V4580, EAN 4047728**045803**
Weichschaumeinlage ohne Ausfräsung



V4631, EAN 4047728**046312**
Weichschaumeinlage ohne Ausfräsung

V4632, EAN 4047728**046329**
Weichschaumeinlage ohne Ausfräsung

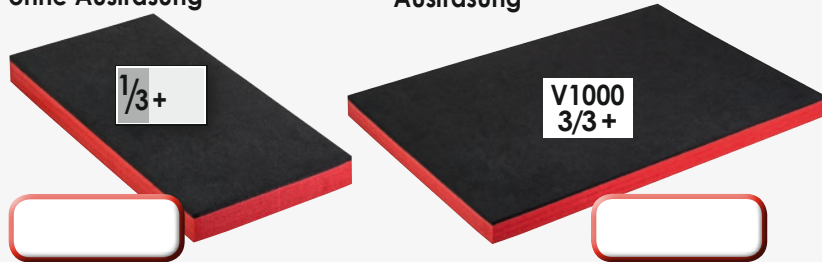

V2237, EAN 4047728**022378**
Adapter-Einlage
Einlagengrößen: 44 x 342 mm

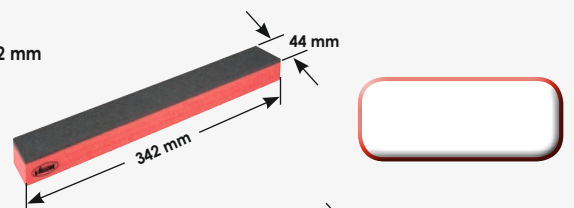

V2238, EAN 4047728**022385**
Adapter-Einlage
Einlagengrößen: 51 x 563 mm

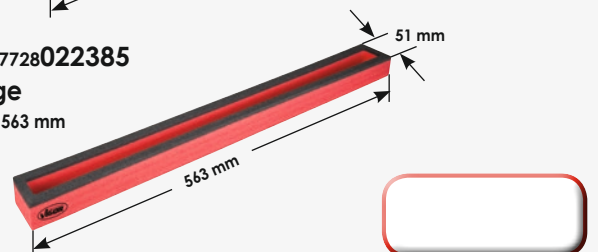

V2607, EAN 4047728026079

6.3 1/4 Steckschlüssel-Werkzeug-Satz

6.3 1/4 4 · 4.5 · 5 · 5.5 · 6 · 7 · 8 · 9
10 · 11 · 12 · 13 · 14 mm

6.3 1/4 4 · 5 · 6 · 7 · 8 · 9 · 10 mm

6.3 1/4 T 10 · T 15 · T 20 · T 25 · T 30 · T 40

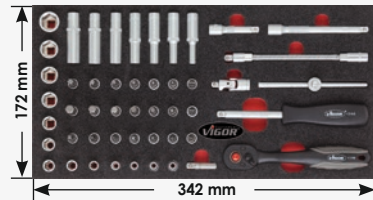

49

2K

- 4 · 5.5 · 7 mm
- ⊕ PH 1 · PH 2 · PH 3
- ⊕ PZ 1 · PZ 2 · PZ 3
- SW 3 · 4 · 5 · 6 · 7 · 8 mm



V2612, EAN 4047728026123
Weichschaum-Einlage, leer



V2606, EAN 4047728026062

10 3/8 Steckschlüssel-Werkzeug-Satz

10 3/8 6 · 7 · 8 · 9 · 10 · 11 · 12 · 13 · 14 · 15
16 · 17 · 18 · 19 · 20 · 21 · 22 · 24 mm

10 3/8 8 · 9 · 10 · 11 · 12 · 13 · 14 · 15 · 17 · 19 mm

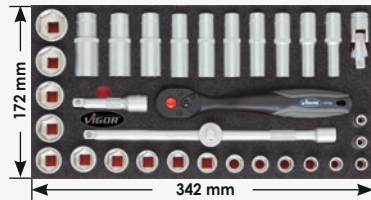

33

2K

- 4 · 5.5 · 7 mm
- ⊕ PH 1 · PH 2 · PH 3
- ⊕ PZ 1 · PZ 2 · PZ 3
- SW 3 · 4 · 5 · 6 · 7 · 8 mm



V2560, EAN 4047728025607
Weichschaum-Einlage, leer



V2605, EAN 4047728026055

12.9 1/2 Steckschlüssel-Werkzeug-Satz

12.9 1/2 10 · 11 · 12 · 13 · 14 · 15 · 16 · 17 · 18
19 · 20 · 21 · 22 · 23 · 24 · 27 · 32 mm



23

2K

- 4 · 5.5 · 7 mm
- ⊕ PH 1 · PH 2 · PH 3
- ⊕ PZ 1 · PZ 2 · PZ 3
- SW 3 · 4 · 5 · 6 · 7 · 8 mm



V2611, EAN 4047728026116
Weichschaum-Einlage, leer



V1658, EAN 4047728016582

12.9 1/2 Steckschlüssel-Einsatz-Sortiment, lang

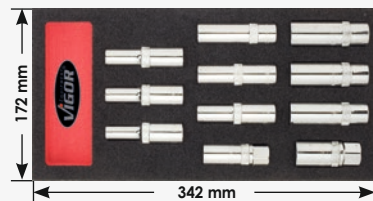

11

2K

- 10 · 11 · 12 · 13 · 14
15 · 17 · 18 · 19 mm
- 16 · 21 mm



V1652, EAN 4047728016520
Weichschaum-Einlage, leer



V1519, EAN 4047728015196

6.3 1/4 und 12.9 1/2 TORX® und Innenvielzahn-Einsatz-Sortiment (XZN)

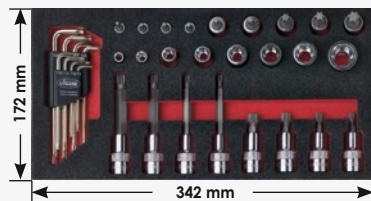

33

2K

- T 9 · T 10 · T 15 · T 20 · T 25 · T 27
T 30 · T 40 · T 45 · T 50 · T 55
- E 8 · E 10 · E 12 · E 14
E 16 · E 18 · E 20 · E 24
- M 6 · M 8 · M 10 · M 12



V1509, EAN 4047728015097
Weichschaum-Einlage, leer



V1661, EAN 4047728016612

6.3 1/4 und 12.9 1/2 TORX® Werkzeug-Satz

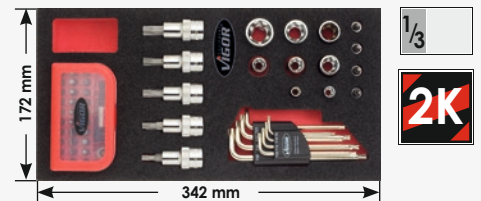

57

2K

- T 9 · T 10 · T 15 · T 20 · T 25 · T 27
T 30 · T 40 · T 45 · T 50 · T 55
- E 8 · E 10 · E 12 · E 14 · E 16
E 18 · E 20 · E 24
- M 6 · M 8 · M 10 · M 12



V1654, EAN 4047728016544
Weichschaum-Einlage, leer



V1682, EAN 4047728016827

12.9 1/2 Innenvielzahn-Einsätze (XZN) und Spiralbohrer-Satz

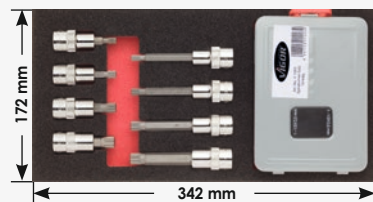

27

2K

- M 6 · M 8 · M 10 · M 12
- M 6 · M 8 · M 10 · M 12
- 1 - 10 mm



V1667, EAN 4047728016674
Weichschaum-Einlage, leer



V1660, EAN 4047728016605

12.9 1/2 Innensechskant-Werkzeug-Satz



19

2K

- 5 · 6 · 7 · 8 · 10 mm
- 5 · 6 · 7 · 8 · 10 mm
- 1.5 · 2 · 2.5
3 · 4 · 5 · 6
8 · 10 mm



V1653, EAN 4047728016537
Weichschaum-Einlage, leer



V1522, EAN 4047728015226

Spiralbohrer- und Schaber-Satz



23

2K

- 1 - 10 mm



V1512, EAN 4047728015127
Weichschaum-Einlage, leer





Weichschaum-Einlagen

V1683, EAN 4047728016834
Doppel-Maulschlüssel-Satz
 • DIN 3113

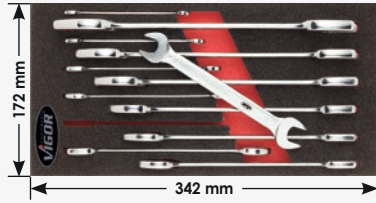

6x7 · 8x9 · 10x11 · 12x13
 14x15 · 16x17 · 18x19
 20x22 · 21x23 · 24x27
 25x28 · 30x32 mm



V1668, EAN 4047728016681
 Weichschaum-Einlage, leer



V1662, EAN 4047728016629
Ring-Maulschlüssel-Satz
 • DIN 3113 / ISO 7738



Neu: Jetzt mit SW 16 + 18

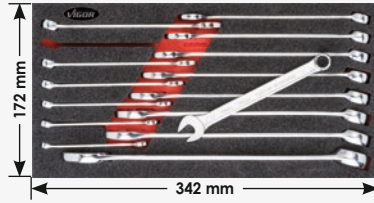

6 · 7 · 8 · 9 · 10 · 11
 12 · 13 · 14 · 15 · 16
 17 · 18 · 19 · 22 mm



V1649, EAN 4047728016490
 Weichschaum-Einlage, leer



V1663, EAN 4047728016636
Ratschen-Ring-Maulschlüssel-Satz

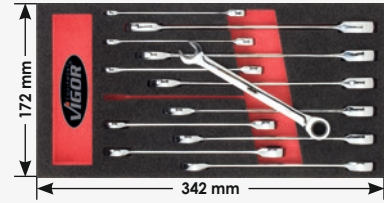

8 · 9 · 10 · 11 · 12 · 13 · 14
 15 · 16 · 17 · 18 · 19 mm



V1651, EAN 4047728016513
 Weichschaum-Einlage, leer



V1664, EAN 4047728016643
Schraubendreher-Satz ⚙️ ⚙️

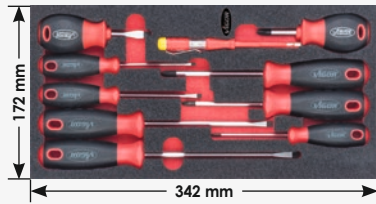

⚙️ 3 · 4 · 5,5 · 6,5 mm
 ⚙️ PH 0 · PH 1 · PH 2



V1655, EAN 4047728016551
 Weichschaum-Einlage, leer



V3646, EAN 4047728036467
Schraubendreher-Satz mit Schlagkappe ⚙️ ⚙️

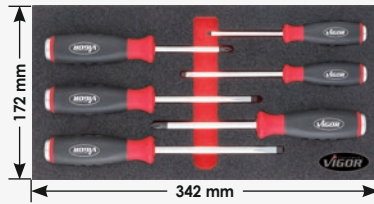

⚙️ 3,5 · 4,5 · 5,5 · 6,5 mm
 ⚙️ PH 1 · PH 2



V3645, EAN 4047728036450
 Weichschaum-Einlage, leer



V3616, EAN 4047728036160
TORX® Schraubendreher-Satz ⚙️

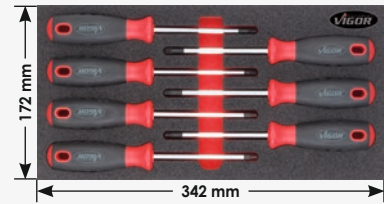

⚙️ T10 · T15 · T20 · T25
 T27 · T30 · T40



V3621, EAN 4047728036214
 Weichschaum-Einlage, leer



V3382, EAN 4047728033824
Zangen-Satz

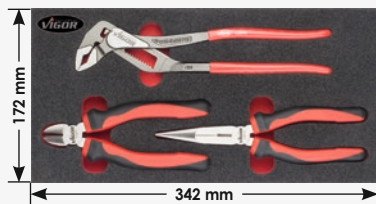

250 mm
 200 mm
 160 mm



V3384, EAN 4047728033848
 Weichschaum-Einlage, leer



V3394, EAN 4047728033947
Zangen-Satz



250 mm
 200 mm
 160 mm



V3395, EAN 4047728033954
 Weichschaum-Einlage, leer



V3396, EAN 4047728033961
Doppelgelenk-Zangen-Satz

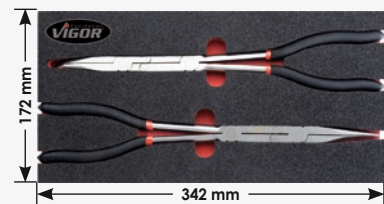

250 mm
 200 mm
 160 mm



V3397, EAN 4047728033978
 Weichschaum-Einlage, leer



Weichschaum-Einlagen



V1729, EAN 4047728017299
Grip-Zangen-Satz

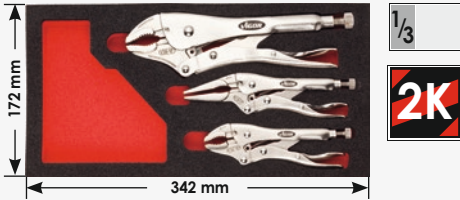

V1746, EAN 4047728017466
Schaber- und Hakensatz
inkl. Autolichtprüfer



V1811, EAN 4047728018111
Feilen-Satz

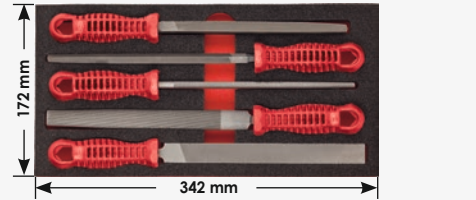

V1807, EAN 4047728018074
Weichschaum-Einlage, leer



V1745, EAN 4047728017459
Weichschaum-Einlage, leer



V1806, EAN 4047728018067
Weichschaum-Einlage, leer



V3383, EAN 4047728033831
Hammer-, Meißel- und
Durchreiber-Satz



V1523, EAN 4047728015233
Messer-, Schaber- und
Pinzetten-Satz

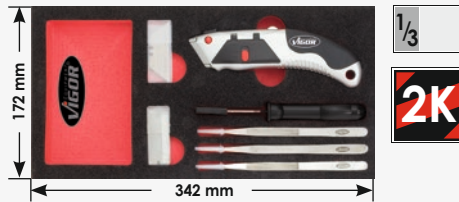

V2239, EAN 4047728022392
2K-Weichschaum-Einlage,
mit Leerfach



V3385, EAN 4047728033855
Weichschaum-Einlage, leer



V1514, EAN 4047728015141
Weichschaum-Einlage, leer



V3644, EAN 4047728036443
VDE-Steckschlüssel-Satz

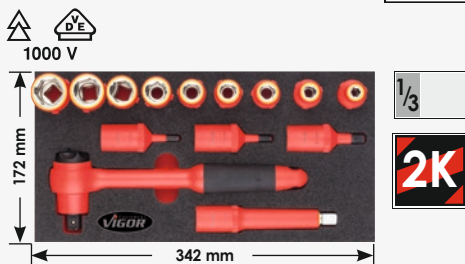

● 8 · 10 · 12 · 13 · 14
17 · 19 · 22 · 24 mm

○ 5 · 6 · 8 mm

12 $\frac{1}{2}$ 125 mm

12 $\frac{1}{2}$ 255 mm



V2015, EAN 4047728020152
VDE-Schraubendreher-Satz

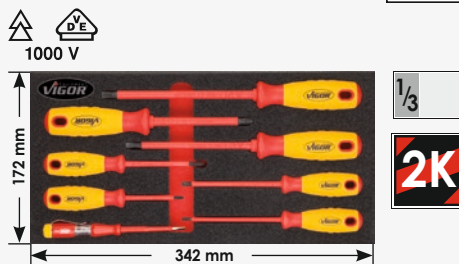

● 3 · 4 · 5,5 · 6,5 mm

⊕ PH 0 · PH 1 · PH 2



V3648, EAN 4047728036481
VDE-Zangen-Satz

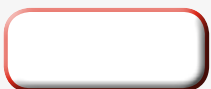
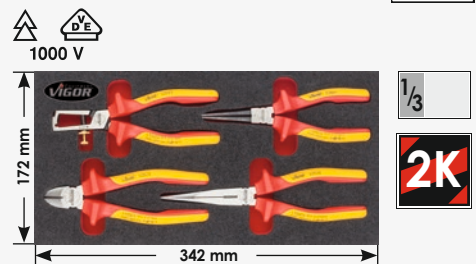

V3643, EAN 4047728036436
Weichschaum-Einlage, leer



V2240, EAN 4047728022408
Weichschaum-Einlage, leer



V3647, EAN 4047728036474
Weichschaum-Einlage, leer





Weichschaum-Einlagen

V1665, EAN 4047728016650
 $\frac{6.3}{3}$ $\frac{1}{4}$ und $\frac{12.9}{2}$ Steckschlüssel-
 Werkzeug-Satz

41

$\frac{2}{3}$ **2K**

342 mm
344 mm

$\frac{6.3}{3}$ $\frac{1}{4}$ ●
 4 · 5 · 5.5 · 6 · 7
 8 · 9 · 10 · 11 · 12
 13 · 14 mm
 $\frac{12.9}{2}$ $\frac{1}{2}$ ●
 10 · 11 · 12 · 13
 14 · 15 · 16 · 17
 18 · 19 · 20 · 21
 22 · 24 · 27 · 30
 32 mm

V1656, EAN 4047728016568
 Weichschaum-Einlage, leer

V1521, EAN 4047728015219
 Hammer-, Zangen- und
 Meißel-Satz

15

$\frac{2}{3}$ **2K**

342 mm
344 mm

V1511, EAN 4047728015110
 Weichschaum-Einlage, leer

V1518, EAN 4047728015189
 Schraubendreher-Satz
 mit Bit-Box

48

$\frac{2}{3}$ **2K**

342 mm
344 mm

● 1,6 – 8 mm
 ● PH 00 – PH 3
 ● PZ 1 – PZ 3
 ● 3 – 6 mm
 ● T 15 – T 70
 ● E 8 – E 24

V1507, EAN 4047728015073
 Weichschaum-Einlage, leer

V2033, EAN 4047728020336
 $\frac{12.9}{2}$ TORX® Schraubendreher-
 Einsatz-Sortiment

40

$\frac{2}{3}$ **2K**

342 mm
344 mm

$\frac{12.9}{2}$ $\frac{1}{2}$ ●
 T 20 · T 25 · T 27
 T 30 · T 40 · T 45
 T 50 · T 55 · T 60
 T 70
 $\frac{12.9}{2}$ $\frac{1}{2}$ ●
 E 8 · E 10 · E 12
 E 14 · E 16 · E 18
 E 20 · E 24

V2021, EAN 4047728020213
 Weichschaum-Einlage, leer

V2032, EAN 4047728020329
 $\frac{12.9}{2}$ Innenvielzahn Schrauben-
 dreher-Einsatz (XZN) Sortiment

26

$\frac{2}{3}$ **2K**

342 mm
344 mm

$\frac{12.9}{2}$ $\frac{1}{2}$ ●
 M 5 · M 6 · M 8
 M 9 · M 10 · M 12
 M 14 · M 16

V1900, EAN 4047728019002
 Weichschaum-Einlage, leer

V2022, EAN 4047728020220
 $\frac{12.9}{2}$ Innensechskant Schrauben-
 dreher-Einsatz-Sortiment

30

$\frac{2}{3}$ **2K**

342 mm
344 mm

$\frac{12.9}{2}$ $\frac{1}{2}$ ●
 5 · 6 · 7 · 8 · 10
 11 · 12 · 13 · 14
 17 · 19 mm

V1899, EAN 4047728018999
 Weichschaum-Einlage, leer

V2258, EAN 4047728022583
 $\frac{12.9}{2}$ RIBE Schraubendreher-
 Einsatz-Sortiment

32

$\frac{2}{3}$ **2K**

342 mm
344 mm

$\frac{12.9}{2}$ $\frac{1}{2}$ ●
 M 5 · M 6 · M 7
 M 8 · M 9 · M 10
 M 10,3 · M 12
 M 13 · M 14

V2259, EAN 4047728022590
 Weichschaum-Einlage, leer

V2672, EAN 4047728026727
 $\frac{12.9}{2}$ Schraubendreher-
 Einsatz-Sortiment

36

$\frac{2}{3}$ **2K**

342 mm
344 mm

● M 5 – M 16
 ● SW 5 – 19 mm
 ● M 5 – M 14
 ● T 20 – T 70

V2671, EAN 4047728026710
 Weichschaum-Einlage, leer

V2378, EAN 4047728023788
 $\frac{6.3}{3}$ $\frac{1}{4}$ $\frac{12.9}{2}$ Steckschlüssel-
 Werkzeug-Satz

79

$\frac{3}{3}$ **2K** $\frac{6.3}{3}$ $\frac{1}{4}$ ● SW 4 – 14 mm
 $\frac{12.9}{2}$ $\frac{1}{2}$ ● SW 10 – 32 mm

342 mm
519 mm

V2373, EAN 4047728023733
 Weichschaum-Einlage, leer

V2364, EAN 4047728023641

Steckschlüssel-Werkzeug-Satz

- 19 · 21 · 22 · 23 · 24 · 26 · 27
28 · 30 · 32 · 34 · 36 · 38 · 41
46 · 50 mm
- 100, 200, 400 mm
- 450 mm

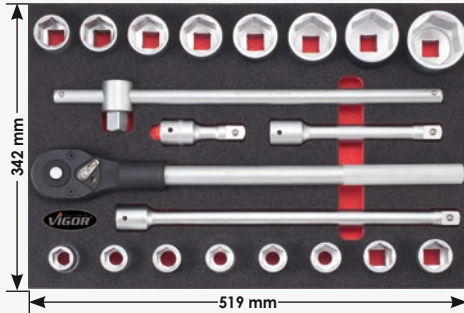

V2363, EAN 4047728023634
Weichschaum-Einlage, leer



V2375, EAN 4047728023757

Doppel-Maul-, Doppel-Ring- und Ring-Maulschlüssel-Satz

Neu: Jetzt mit
SW 16 + 18

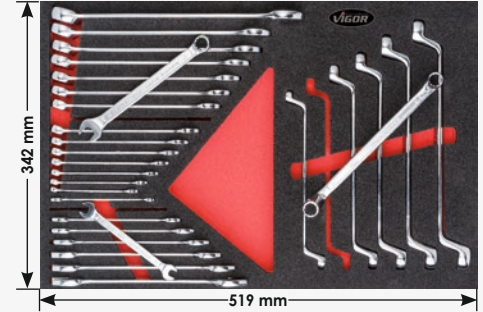

- 6x7 · 8x9 · 10x11 · 12x13 · 14x15 · 16x17 · 18x19 · 20x22 mm
- 6 · 7 · 8 · 9 · 10 · 11 · 12 · 13 · 14 · 15 · 16 · 17 · 18 · 19 · 22 mm
- 10x11 · 12x13 · 14x15 · 16x17 · 18x19 · 20x22 mm

V2374, EAN 4047728023740
Weichschaum-Einlage, leer



V1517, EAN 4047728015172

Ratschen-Ring-Maulschlüssel und 15°
gekröpfte Ring-Maulschlüssel-Satz

Neu: Jetzt mit
SW 16 + 18

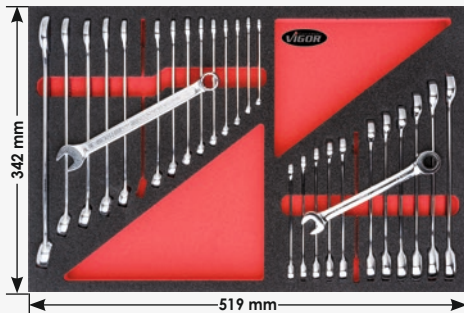

- 8 · 9 · 10 · 11 · 12 · 13 · 14 · 15 · 16 · 17 · 18 · 19 mm
- 6 · 7 · 8 · 9 · 10 · 11 · 12 · 13 · 14 · 15 · 16 · 17 · 18 · 19 · 22 mm

V1506, EAN 4047728015066
Weichschaum-Einlage, leer



V1525, EAN 4047728015257

Doppel-Ringschlüssel- und Doppel-Maulschlüssel-Satz

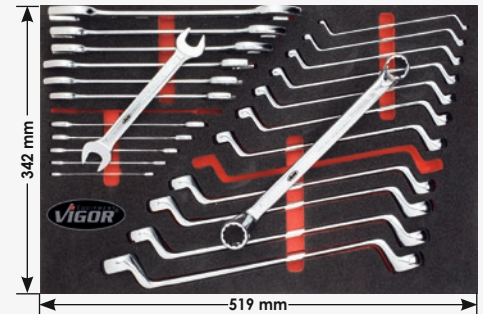

- 6x7 · 8x9 · 10x11 · 12x13 · 14x15 · 16x17 · 18x19
20x22 · 21x23 · 24x27 · 25x28 · 30x32 mm
- 6x7 · 8x9 · 10x11 · 12x13 · 14x15 · 16x17 · 18x19
20x22 · 21x23 · 24x27 · 25x28 · 30x32 mm

V1513, EAN 4047728015134
Weichschaum-Einlage, leer



V1747, EAN 4047728017473

Schraubenschlüssel-Sortiment

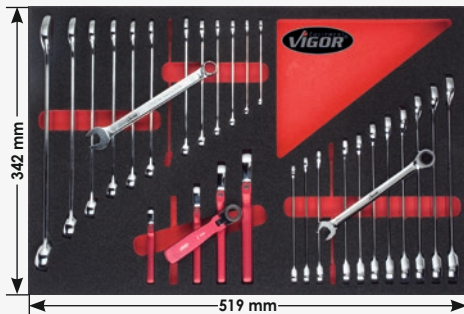

- 8 · 9 · 10 · 11 · 12 · 13 · 14 · 15 · 16 · 17 · 18 · 19 mm
- 6 · 7 · 8 · 9 · 10 · 11 · 12 · 13 · 14 · 15 · 17 · 19 · 22 mm
- 8 · 10 · 13 · 16 · 19 mm

V1743, EAN 4047728017435
Weichschaum-Einlage, leer



V1520, EAN 4047728015202

TORX® und Sechskant-T-Griff-
Schraubendreher-Satz

- T 9 · T 10 · T 15 · T 20
T 25 · T 27 · T 30 · T 40
- 2 · 2,5 · 3 · 4 · 5 · 6 · 8 ·
10 mm

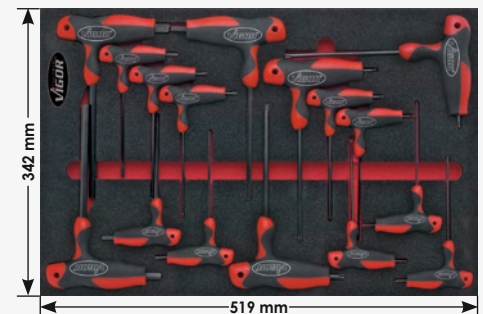

V1510, EAN 4047728015103
Weichschaum-Einlage, leer



V2376, EAN 4047728023764
Schraubendreher- und Zangen-Satz

54

3/3 **2K**
 3 - 4 - 5,5 - 6,5
 PH 0 - PH 1 - PH 2



V2377, EAN 4047728023771
Weichschaum-Einlage, leer



V3606, EAN 4047728036061
Zangen-Satz

10

3/3 **2K**

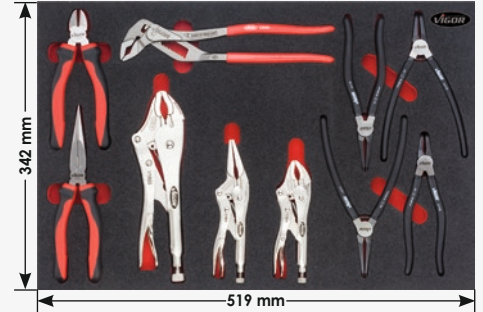

V3605, EAN 4047728036054
Weichschaum-Einlage, leer



V1748, EAN 4047728017480
Mess-, Schneidwerkzeug-, Zangen-Satz

30

3/3 **2K**



V1871, EAN 4047728018715
Weichschaum-Einlage, leer



V4188, EAN 4047728041881
Steckschlüssel-Werkzeug-Satz

172

V1000 **2K**
3/3+

- SW 4 - 32 mm
- E 4 - E 22
- SW 3 - 19 mm
- SW 4 - 12 mm
- PH 0 - PH 4
- PZ 0 - PZ 4
- T 5 - T 70
- T 7 H - T 70 H
- M 5 - M 8
- M 5 - M 9

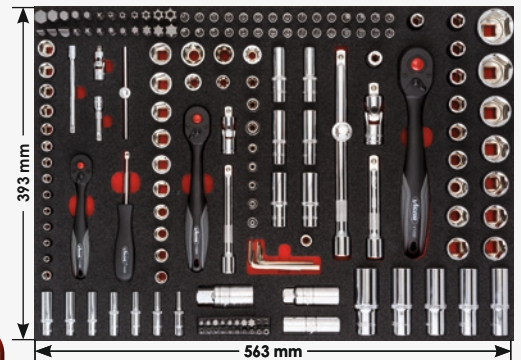

V4130, EAN 4047728041300
Weichschaum-Einlage, leer



V2837, EAN 4047728028370
Steckschlüssel-Einsatz-Sortiment

64

- V1000** **2K**
3/3+
- 12² 1/2 ● M5 - M16
 - 12² 1/2 ● SW 5 - 19 mm
 - 12² 1/2 ● M 5 - M 14
 - 12² 1/2 ● T 20 - T 70
 - 6.3 1/4 ● E 4 - E 11
 - 10 3/8 ● E 4 - E 20
 - 12² 1/2 ● E 10 - E 24

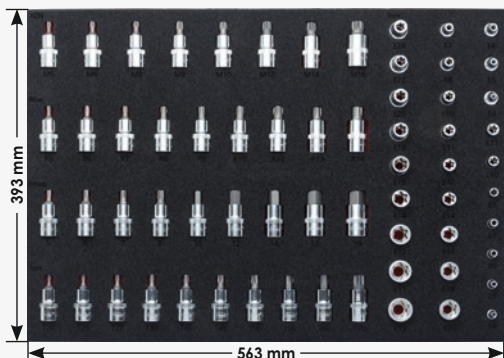

V2838, EAN 4047728028387
Weichschaum-Einlage, leer



V2007, EAN 4047728020077
Schraubendreher- und Schaber-Satz

40

V1000 **2K**
3/3+
 3 - 4 - 5,5 - 6,5 mm
 PH 0 - PH 1 - PH 2



V1973, EAN 4047728019736
Weichschaum-Einlage, leer



V4230, EAN 4047728**042307**
Schraubendreher-Satz

32

V1000 3/3+ 2K

- 3 · 3,5 · 4 · 4,5 · 5,5 · 6,5 · 8 · 10 mm
- ⊕ PH 0 · PH 1 · PH 2 · PH 3
- ⊕ T10 · T15 · T20 · T25 · T27 · T30 · T40
- SW 6 · 7 · 8 · 10 · 12 · 13 mm

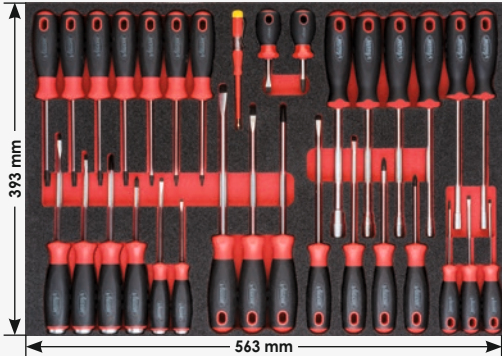

V4231, EAN 4047728**042314**
Weichschaum-Einlage, leer



V4239, EAN 4047728**042390**
Hammer-, Zangen-, Schraubendreher-Satz

40

V1000 3/3+ 2K

- 3 · 4 · 5,5 · 6,5 mm
- ⊕ PH 0 · PH 1 · PH 2

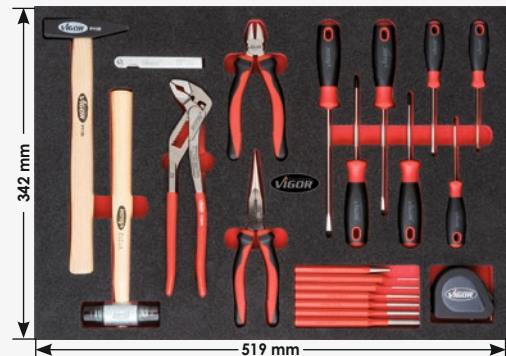

V4240, EAN 4047728**042406**
Weichschaum-Einlage, leer



V2006, EAN 4047728**020060**
TORX® und Sechskant T-Griff-Schraubendreher-Satz

33

V1000 3/3+ 2K

- ⊕ T 9 · T 10 · T 15 · T 20 · T 25 · T 27 · T 30 · T 40
- SW 2 · 2,5 · 3 · 4 · 5 · 6 · 8 · 10 mm

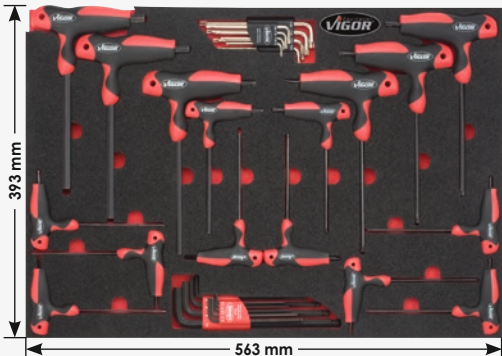

V1972, EAN 4047728**019729**
Weichschaum-Einlage, leer



V2008, EAN 4047728**020084**
Doppel-Ringschlüssel-, Doppel-Maulschlüssel-, Ring-Maulschlüssel-Satz

36

V1000 3/3+ 2K

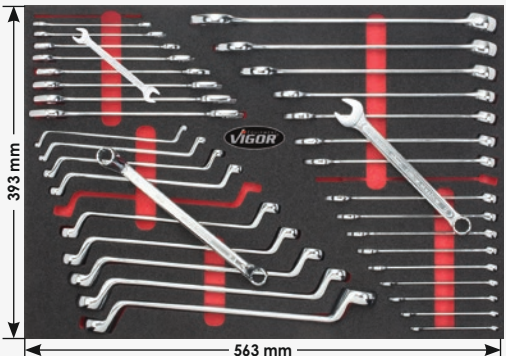

- ⊕ 6x7 · 8x9 · 10x11 · 12x13 · 14x15 · 16x17 · 18x19 · 20x22 · 21x23 mm
- ⊕ 6 · 7 · 8 · 9 · 10 · 11 · 12 · 13 · 14 · 15 · 16 · 17 · 18 · 19 · 22 · 24 · 27 mm
- ⊕ 6x7 · 8x9 · 10x11 · 12x13 · 14x15 · 16x17 · 18x19 · 20x22 · 21x23 · 24x27 mm

V1974, EAN 4047728**019743**
Weichschaum-Einlage, leer



V2009, EAN 4047728**020091**
Zangen-, Hammer- und Meißel-Satz

40

V1000 3/3+ 2K



V1975, EAN 4047728**019750**
Weichschaum-Einlage, leer



V4587, EAN 4047728**045872**
Steckschlüssel-Satz

NEU 102

V1000 3/3+ 2K

- 6.3 1/4 ● 4 - 14 mm
- 6.3 1/4 ○ 3 · 4 · 5 · 6 mm
- 6.3 1/4 ● E4 · E5 · E6 · E8
- 6.3 1/4 ● T10 - T27
- 6.3 1/4 ⊕ PH1 · PH2
- 12.2 1/2 ● 32 - 36 mm
- 12.2 1/2 ● 10 - 32 mm
- 12.2 1/2 ● E10 - E20
- 12.2 1/2 ● T25 - T60
- 12.2 1/2 ○ 10 - 32 mm



V4514, EAN 4047728**045148**
Weichschaum-Einlage, leer



V4588, EAN 4047728**045889**
Schraubendreher-Satz

NEU **26**

V1000
3/3+ **2K**

- 3 · 4 · 4,5 · 5,5
6,5 · 8 · 10 mm
- PH 1 · PH 2 · PH 3
- T6 · T7 · T8 · T9 · T10
T15 · T20 · T25 · T27
T30 · T40

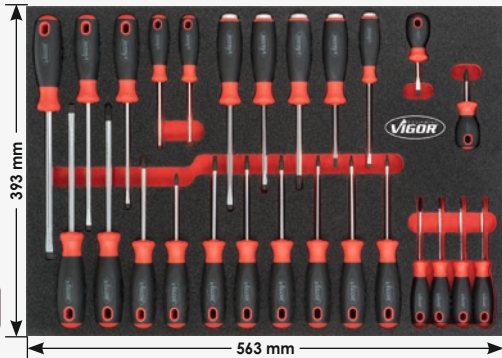

V4589, EAN 4047728**045896**

Steckschlüssel-Einsatz-, Winkelschrauben-
dreher-, Ratschen-Ring-Maulschlüssel-Satz

NEU **47**

V1000
3/3+ **2K**

- 12⁹ 1/2 ⌀ 1,5 · 2 · 2,5 · 3 ·
4 · 5 · 6 · 7 · 8 ·
10 · 12 · 14 · 17 ·
19 mm
- 12⁹ 1/2 ⌀ 5 · 6 · 8 · 10 · 12
14 · 16 mm

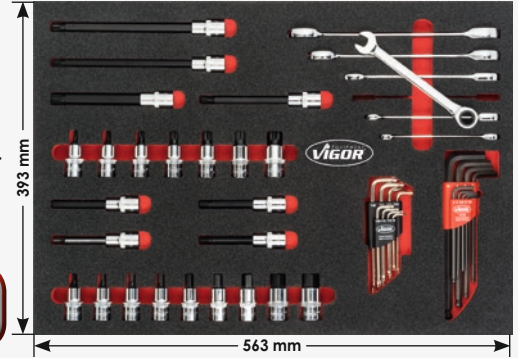

- 12⁹ 1/2 ⌀ T9 · T10 · T15 · T20 · T25 · T27 · T30 · T40
- 8 · 10 · 12 · 13 · 17 · 19 mm

V4501, EAN 4047728**045018**
Weichschaum-Einlage, leer



V4512, EAN 4047728**045124**
Weichschaum-Einlage, leer



V4590, EAN 4047728**045902**
Ring-Maulschlüssel-,
Doppel-Ringschlüssel-Satz

NEU **25**

V1000
3/3+ **2K**

- 6x7 · 8x9 · 10x11 · 12x13 · 14x15 · 16x17 · 18x19 · 21x23 mm
- 6 · 7 · 8 · 9 · 10 · 11 · 12 · 13 · 14 · 15 · 16 · 17 · 18 · 19 · 21 · 22 · 24 mm

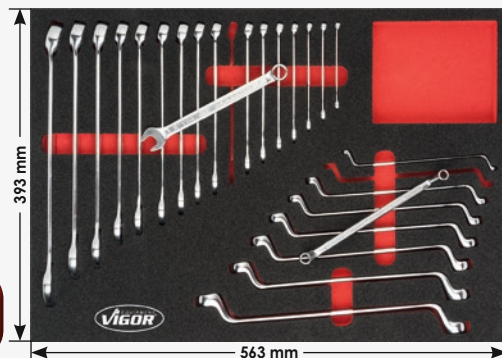

V4584, EAN 4047728**045841**
Ring-Maulschlüssel-, Verlängerung-,
Montiereisen-Satz

NEU **8**

V1000
3/3+ **2K**

- 24x27 · 30x32 mm
- 27 · 30 · 32 mm

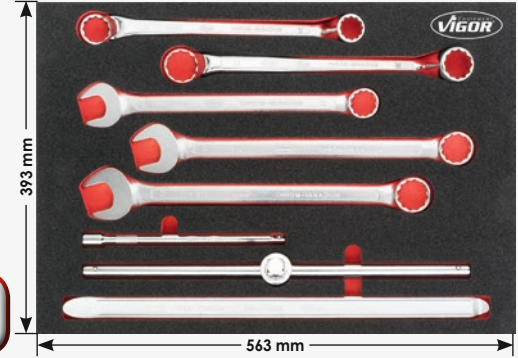

V4503, EAN 4047728**045032**
Weichschaum-Einlage, leer



V4505, EAN 4047728**045056**
Weichschaum-Einlage, leer



V4508, EAN 4047728**045087**
Zangen-Satz

NEU **9**

V1000
3/3+ **2K**



V4511, EAN 4047728**045117**
Hammer-, Meißel-, Splintreiber – Satz

NEU **37**

V1000
3/3+ **2K**



V4507, EAN 4047728**045070**
Weichschaum-Einlage, leer

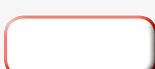

V4510, EAN 4047728**045100**
Weichschaum-Einlage, leer



Weichschaum-Einlagen



V4586, EAN 4047728**045865**
Steckschlüssel-Werkzeug-Satz
 für VIGOR 1000 XL

V1000 XL
 4/3+ **2K**

- SW 4 - 32 mm
- E 4 - E 22
- SW 3 - 19 mm
- SW 4 - 12 mm
- PH 0 - PH 4
- PZ 0 - PZ 4
- T 5 - T 70
- T 7 H - T 70 H
- M 5 - M 8
- M 5 - M 9
- 12³/₂ ● M 5 - M 16
- 12³/₂ ● M 5 - 14 mm
- 12³/₂ ● T 20 - T 70

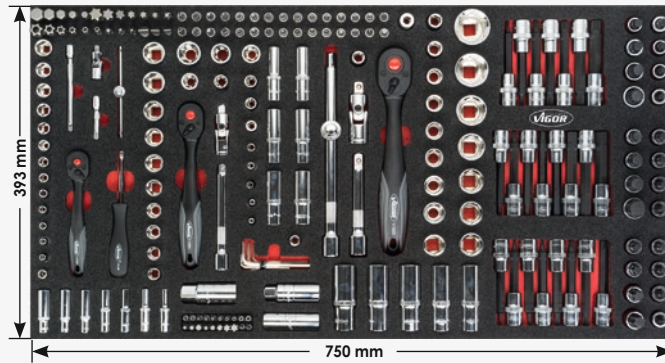

NEU **219**



V4521, EAN 4047728**045216**
Weichschaum-Einlage, leer



V4524, EAN 4047728**045247**
Ring-Maul-, Doppelring-Maulschlüssel-Satz
 für VIGOR 1000 XL

V1000 XL
 4/3+ **2K**

- 6x7 · 8x9 · 10x11 · 12x13 · 14x15 · 16x17 · 18x19 · 20x22 · 21x23 · 24x27 · 25x28 · 30x32 mm
- 6x7 · 8x9 · 10x11 · 12x13 · 14x15 · 16x17 · 18x19 · 20x22 · 21x23 · 24x27 · 25x28 · 30x32 mm
- 6 · 7 · 8 · 9 · 10 · 11 · 12 · 13 · 14 · 15 · 16 · 17 · 18 · 19 · 20 · 21 · 22 · 24 · 27 · 30 · 32 · 36 mm
- 8 · 9 · 10 · 11 · 12 · 13 · 14 · 15 · 16 · 17 · 18 · 19 mm

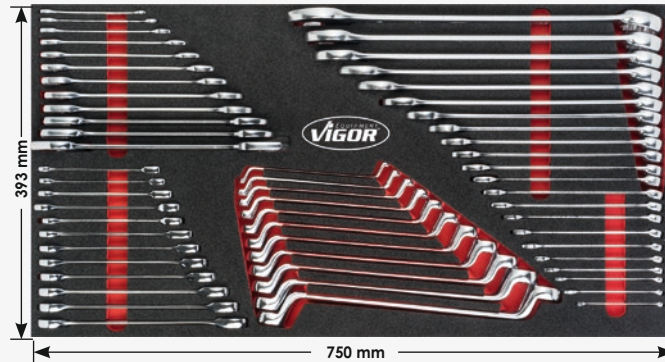

NEU **58**



V4523, EAN 4047728**045230**
Weichschaum-Einlage, leer



V4518, EAN 4047728**045919**
Schraubendreher-Satz
 für VIGOR 1000 XL

V1000 XL
 4/3+ **2K**

- 1,6 · 2 · 2,4 · 3 · 3,5 · 4 · 4,5 · 5,5 · 6,5 · 8 · 10 mm
- PH · 00 · PH 0 · PH 1 · PH 2 · PH 3
- T6 · T7 · T8 · T9 · T10 · T15 · T20 · T25 · T27 · T30 · T40
- 1,5 · 2 · 2,5 · 3 · 4 · 5 · 6 · 7 · 8 · 10 mm



NEU **59**



V4517, EAN 4047728**045179**
Weichschaum-Einlage, leer



V4585, EAN 4047728**045858**
Hammer-, Zangen-, Splinttreiber-Satz
 für VIGOR 1000 XL

V1000 XL
 4/3+ **2K**



NEU **38**



V4519, EAN 4047728**045193**
Weichschaum-Einlage, leer



V2542, EAN 4047728025423

Universal-Werkzeugkoffer

• Werkzeug-Koffer inkl. Sortiment

143

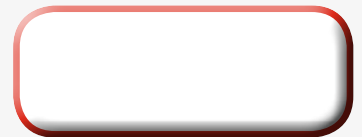

V2602

VIGOR No.	Bezeichnung	EAN 4047728+	
V2400	Koffer, leer, ohne Weichschaum-Einlage	024006	
V2464	Weichschaumeinlage Universal-Werkzeugkoffer	024648	

V1425, EAN 4047728014250

Werkzeugkoffer

• Trageeinsatz mit Bithalter und Maßeinteilung (cm/inch)



Universal Werkzeugkoffer



V4425, EAN 4047728044257
 Universal Werkzeugkoffer

95

NEU



X	Ausführung	■	SW mm / mm
12 x		—	8 · 9 · 10 · 11 · 12 · 13 · 14 15 · 16 · 17 · 18 · 19 · mm
4 x		—	3 · 4 · 5,5 · 6,5 mm
3 x		—	PH 0 · PH 1 · PH 2
1 x		—	160 mm
1 x		—	200 mm
9 x		—	1,5 · 2 · 2,5 · 3 · 4 · 5 · 6 · 8 · 10 mm
9 x		—	T10 · T15 · T20 · T25 · T27 · T30 · T40 · T45 · T50
1 x		—	300 g
1 x		6.3 1/4	150 mm
1 x		6.3 1/4	100 mm
1 x		6.3 1/4	40 mm

X	Ausführung	■	SW mm / mm
12 x		6.3 1/4	4 · 4,5 · 5 · 5,5 · 6 · 7 · 8 · 9 · 10 · 11 · 12 · 13 mm
4 x		6.3 1/4	3 · 4 · 5 · 6 mm
3 x		6.3 1/4	0,8x4 · 1x5,5 · 1,2x6,5 mm
3 x		6.3 1/4	PH 1 · PH 2 · PH 3
3 x		6.3 1/4	PZ 1 · PZ 2 · PZ 3
7 x		6.3 1/4	T 10 · T 15 · T 20 · T 25 · T 27 · T 30 · T 40
1 x		12.1 1/2	250 mm
1 x		12.1 1/2	125 mm
1 x		12.1 1/2	75 mm
16 x		12.1 1/2	10 · 11 · 12 · 13 · 14 · 15 · 16 · 17 · 19 · 20 · 21 · 22 · 24 · 27 · 30 · 32 mm



V3734, EAN 4047728037341

6.3 1/4" Steckschlüssel-Satz



Einzelteilaufstellung ab Seite 54

X	Ausführung	■	SW / L mm
12 x		6.3 1/4"	4 · 4,5 · 5 · 5,5 · 6 · 7 · 8 · 9 · 10 · 11 · 12 · 13 mm
2 x		6.3 1/4"	PH 1 · PH 2
2 x		6.3 1/4"	PZ 1 · PZ 2
4 x		6.3 1/4"	T 15 · T 20 · T 25 · T 30
1 x		6.3 1/4"	100 mm
1 x		6.3 1/4"	25 mm
1 x		6.3 1/4"	150 mm



V2414, EAN 4047728024143

6.3 1/4" Steckschlüssel-Satz



Einzelteilaufstellung ab Seite 54

X	Ausführung	■	SW / L mm
13 x		6.3 1/4"	4 · 4,5 · 5 · 5,5 · 6 · 7 · 8 · 9 · 10 · 11 · 12 · 13 · 14 mm
3 x		6.3 1/4"	0,8x4 · 1x5,5 · 1,2x7 mm
6 x		6.3 1/4"	3 · 4 · 5 · 6 · 7 · 8 mm
3 x		6.3 1/4"	PH 1 · PH 2 · PH 3
3 x		6.3 1/4"	PZ 1 · PZ 2 · PZ 3
6 x		6.3 1/4"	T 10 · T 15 · T 20 · T 25 · T 30 · T 40
4 x		6.3 1/4"	1,27 · 1,5 · 2 · 2,5 mm
1 x		6.3 1/4"	145 mm
1 x		6.3 1/4"	110 mm
1 x		6.3 1/4"	50 mm
2 x		6.3 1/4"	100 · 145 mm
1 x		6.3 1/4"	40 mm
1 x		6.3 1/4"	150 mm
1 x		6.3 1/4"	150 mm

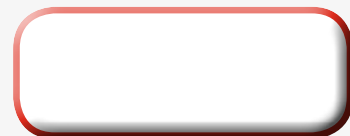

6.3 1/4"

Steckschlüssel-Systeme



V4217, EAN 4047728042178

6.3 1/4" Multiprofil Steckschlüssel-Satz

6.3 1/4"

40



Einzelteillaufistung ab Seite 54

X	Ausführung	SW mm	mm
13 x		6.3 1/4"	4 · 4.5 · 5 · 5.5 · 6 · 7 · 8 · 9 · 10 · 11 · 12 · 13 · 14 mm
6 x		6.3 1/4"	3 · 4 · 5 · 6 · 7 · 8 mm
2 x		6.3 1/4"	PH 1 · PH 2
2 x		6.3 1/4"	PZ 1 · PZ 2
6 x		6.3 1/4"	T 10 · T 15 · T 20 · T 25 · T 27 · T 30 · T 40 mm
5 x		6.3 1/4"	M4 · M5 · M5 · M8 · M10
1 x		6.3 1/4"	
1 x		6.3 1/4"	100
1 x		6.3 1/4"	40 mm
1 x		6.3 1/4"	150 mm
1 x		6.3 1/4"	152 mm



V1897, EAN 4047728018975

6.3 1/4" Multiprofil Steckschlüssel-Satz

6.3 1/4"

12



Multiprofile

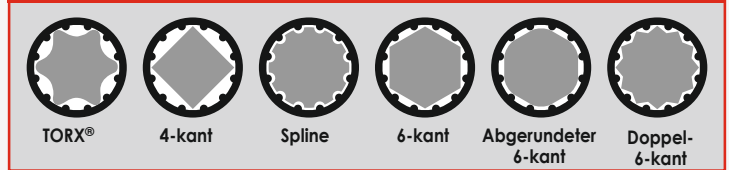

Alle Einsätze für 6 Profile geeignet!



Einzelteillaufistung ab Seite 54

X	Ausführung	SW mm
12 x		4 · 5 · 5.5 · 6 · 7 · 8 · 9 · 10 · 11 · 12 · 13 · 14

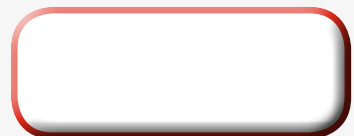

6.3 1/4" Steckschlüssel-Einsatz



VIGOR No.	SW mm	l mm	EAN 4047728+
V2413	4	25	024136
V2415	4,5	25	024150
V2416	5	25	024167
V2417	5,5	25	024174
V2418	6	25	024181
V2419	7	25	024198
V2420	8	25	024204
V2421	9	25	024211
V2422	10	25	024228
V2423	11	25	024235
V2424	12	25	024242
V2425	13	25	024259
V2426	14	25	024266

6.3 1/4" Steckschlüssel-Einsatz, lang



VIGOR No.	SW mm	l mm	EAN 4047728+
V2533	4	50	025331
V2534	5	50	025348
V2535	6	50	025355
V2536	7	50	025362
V2537	8	50	025379
V2538	9	50	025386
V2539	10	50	025393
V2699	11	50	026994
V2700	12	50	027007
V2701	13	50	027014

6.3 1/4" TORX® Steckschlüssel-Einsatz



VIGOR No.	SW mm	l mm	EAN 4047728+
V2185	E4	24,8	021852
V2186	E5	24,8	021869
V2187	E6	24,8	021876
V2188	E7	24,8	021883
V2189	E8	24,8	021890
V2722	E10	24,8	027229
V2723	E11	24,8	027236

6.3 1/4" Multiprofil-Steckschlüssel-Einsatz



VIGOR No.	SW mm	l mm	EAN 4047728+
V1976	4	25	019767
V1977	5	25	019774
V1978	5,5	25	019781
V1979	6	25	019798
V1980	7	25	019804
V1981	8	25	019811
V1982	9	25	019828
V1983	10	25	019835
V1984	11	25	019842
V1985	12	25	019859
V1986	13	25	019866
V1987	14	25	019873

6.3 1/4" Schraubendreher-Einsatz



VIGOR No.	SW mm	l mm	EAN 4047728+
V2430	3	38	024303
V2431	4	38	024310
V2432	5	38	024327
V2433	6	38	024334
V2434	7	38	024341
V2435	8	38	024358



Multiprofile

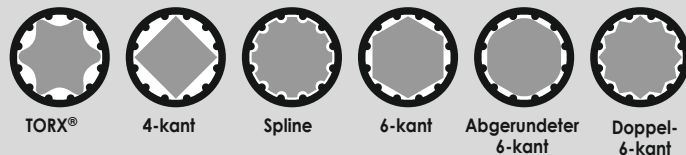

6.3 1/4" Schraubendreher-Einsatz

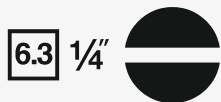

VIGOR No.	SW mm	l mm	EAN 4047728+
V2427	0,8x4	38	024273
V2428	1x5,5	38	024280
V2597	1,2x6,5	38	025973
V2429	1,2x7	38	024297

6.3 1/4" Schraubendreher-Einsatz



VIGOR No.	SW mm	l mm	EAN 4047728+
V2593	PH 0	38	025935
V2436	PH 1	38	024365
V2437	PH 2	38	024372
V2438	PH 3	38	024389

6.3 1/4"

Steckschlüssel-Systeme



6.3 1/4" Schraubendreher-Einsatz



VIGOR No.	SW mm	mm	EAN 4047728+
V2594	PZ 0	38	025942
V2439	PZ 1	38	024396
V2440	PZ 2	38	024402
V2441	PZ 3	38	024419



6.3 1/4" TORX® Schraubendreher-Einsatz



VIGOR No.	SW mm	mm	EAN 4047728+
V2595	T 9	38	025959
V2442	T 10	38	024426
V2443	T 15	38	024433
V2444	T 20	38	024440
V2445	T 25	38	024457
V2446	T 30	38	024464
V2447	T 40	38	024471



6.3 1/4" Schraubendreher-Einsatz

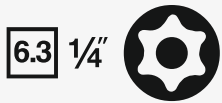

VIGOR No.	SW mm	mm	EAN 4047728+
V2596	T 9 H	38	025966
V2136	T 10 H	37	021364
V2138	T 15 H	37	021388
V2139	T 20 H	37	021395
V2140	T 25 H	37	021401
V2141	T 27 H	37	021418
V2142	T 30 H	37	021425



6.3 1/4" Steckgriff

VIGOR No.	mm	EAN 4047728+
V2458	150	024587



6.3 1/4" Feinzahn-Umschaltknarre

VIGOR No.	mm	EAN 4047728+
V1038	150	010382



6.3 1/4" T-Griff-Umschaltknarre

VIGOR No.	mm	EAN 4047728+
V1032	150	010320



Reparatur-Satz
V3585, EAN 4047728035859

6.3 1/4" 6.3 1/4" Fingerratsche

VIGOR No.	EAN 4047728+
V2941	029414



6.3 1/4" Feinzahn-Umschaltknarre

VIGOR No.	mm	EAN 4047728+
V4212	150	042123



6.3 1/4" Bit-Schraubendreher

VIGOR No.	EAN 4047728+
V3427	034272



6.3 1/4" Gleitgriff

6.3 1/4"

VIGOR No.	mm	EAN 4047728+
V2453	110	024532



6.3 1/4" 6.3 1/4" Universalgelenk

6.3 1/4" 6.3 1/4"

VIGOR No.	mm	EAN 4047728+
V2454	40	024549



6.3 1/4" 6.3 1/4" Flexible Verlängerung

6.3 1/4" 6.3 1/4"

VIGOR No.	mm	EAN 4047728+
V2457	145	024570

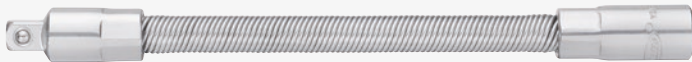

6.3 1/4" 6.3 1/4" Verlängerung

6.3 1/4" 6.3 1/4"

VIGOR No.	mm	EAN 4047728+
V2455	50	024556
V2456	100	024563



6.3 1/4" 6.3 1/4" Schwenkbare Verlängerung

- Mit kugelförmigem, konischem Außenvierkant
- Zur Befähigung von Schraubverbindungen auf engem Raum und Umgehen von Störkanten



6.3 1/4" 6.3 1/4" 8°

VIGOR No.	mm	EAN 4047728+
V4311	36	043113
V4312	75	043120
V4313	250	043137

10 3/8" 6.3 1/4" Adapter

10 3/8" 6.3 1/4"

VIGOR No.	mm	EAN 4047728+
V2014	26	020145



6.3 1/4" 6.3 1/4" Adapter

6.3 1/4" 6.3 1/4"

VIGOR No.	mm	EAN 4047728+
V2452	30	024525



6.3 1/4" 6.3 1/4" Bit-Adapter

6.3 1/4" 6.3 1/4"

VIGOR No.	mm	EAN 4047728+
V3651	25	036511



10 3/8"

Steckschlüssel-Systeme



V2305, EAN 4047728023054

10 3/8" Steckschlüssel-Satz



61



Einzelteillaufistung ab Seite 58

X	Ausführung	SW mm / mm
18 x		6 · 7 · 8 · 9 · 10 · 11 · 12 · 13 · 14 · 15 · 16 · 17 · 18 · 19 · 20 · 21 · 22 · 24 mm
10 x		8 · 9 · 10 · 11 · 12 · 13 · 14 · 15 · 17 · 19 mm
2 x		16 · 21 mm
7 x		3 · 4 · 5 · 6 · 7 · 8 · 10 mm
3 x		0,8x5,5 · 1x7 · 1,2x8 mm
3 x		PH 1 · PH 2 · PH 3
3 x		PZ 1 · PZ 2 · PZ 3
9 x		T 15 · T 20 · T 25 · T 27 · T 30 · T 40 · T 45 · T 50 · T 55
1 x		-
1 x		40 mm
1 x		75 mm
1 x		250 mm
1 x		50 mm
1 x		198 mm

V2737, EAN 4047728027373

10 3/8" Glühkerzen-Steckschlüssel-Satz



6

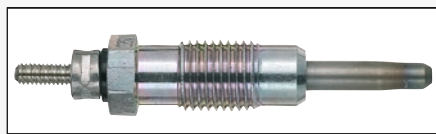

Einzelteillaufistung ab Seite 58

X	SW mm
6 x	8 · 9 · 10 · 12 · 14 · 16 mm

10 3/8" Steckschlüssel-Einsatz



VIGOR No.	SW mm	← L → mm	EAN 4047728+
V2278	6	28	022781
V2277	7	28	022774
V2276	8	28	022767
V2275	9	28	022750
V2274	10	28	022743
V2273	11	28	022736
V2272	12	28	022729
V2271	13	28	022712
V2270	14	28	022705
V2269	15	28	022699
V2268	16	28	022682
V2267	17	30	022675
V2266	18	30	022668
V2265	19	30	022651
V2264	20	30	022644
V2263	21	30	022637
V2262	22	30	022620
V2261	24	30	022613

10 3/8" Steckschlüssel-Einsatz, lang



VIGOR No.	SW mm	← L → mm	EAN 4047728+
V2016	8	63	020169
V2017	9	63	020176
V2018	10	63	020183
V2019	11	63	020190
V2020	12	63	020206
V2311	13	63	023115
V2312	14	63	023122
V2313	15	63	023139
V2314	17	63	023146
V2315	19	63	023153

10 3/8" Glühkerzen-Steckschlüssel



VIGOR No.	SW mm	L2 mm	L1 mm	EAN 4047728+
V2738	8	157	157	027380
V2741	9	157	157	027410
V2742	10	157	157	027427
V2743	12	157	157	027434
V2744	14	157	157	027441
V2739	16	157	157	027397



10 3/8" Zündkerzen-Einsatz



VIGOR No.	SW mm	← L → mm	EAN 4047728+
V2119	16	66	021197
V2613	18	66	026130
V2120	21	66	021203



10 3/8" TORX® Steckschlüssel-Einsatz



VIGOR No.	SW mm	← L → mm	EAN 4047728+
V2724	E 4	28	027243
V2725	E 5	28	027250
V2726	E 6	28	027267
V2727	E 7	28	027274
V2728	E 8	28	027281
V2143	E 10	28	021432
V2614	E 11	28	026147
V2144	E 12	28	021449
V2145	E 14	28	021456
V2146	E 16	28	021463
V2615	E 18	28	026154
V2729	E 20	28	027298

10 3/8"

Steckschlüssel-Systeme



10 3/8" Schraubendreher-Einsatz



VIGOR No.	SW mm	← L → mm	EAN 4047728+
V2285	3	49	022859
V2284	4	49	022842
V2283	5	49	022835
V2282	6	49	022828
V2281	7	49	022811
V2280	8	49	022804
V2279	10	49	022798

10 3/8" Schraubendreher-Einsatz

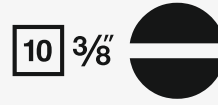

VIGOR No.	SW mm	← L → mm	EAN 4047728+
V2288	0,8x5,5	49	022880
V2287	1x7	49	022873
V2286	1,2x8	49	022866

10 3/8" Schraubendreher-Einsatz



VIGOR No.	SW mm	← L → mm	EAN 4047728+
V2294	PH 1	49	022941
V2293	PH 2	49	022934
V2292	PH 3	49	022927

10 3/8" Schraubendreher-Einsatz

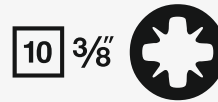

VIGOR No.	SW mm	← L → mm	EAN 4047728+
V2291	PZ 1	49	022910
V2290	PZ 2	49	022903
V2289	PZ 3	49	022897

10 3/8" TORX® Schraubendreher-Einsatz



VIGOR No.	SW mm	← L → mm	EAN 4047728+
V2303	T 15	49	023030
V2302	T 20	49	023023
V2301	T 25	49	023016
V2300	T 27	49	023009
V2299	T 30	49	022996
V2298	T 40	49	022989
V2297	T 45	49	022972
V2149	T 47	49	021494
V2296	T 50	49	022965
V2295	T 55	49	022958

10 3/8" TORX® Schraubendreher-Einsatz

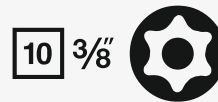

VIGOR No.	SW mm	← L → mm	EAN 4047728+
V2193	T 40 H	48	021937
V2194	T 45 H	48	021944
V2195	T 50 H	48	021951

10 3/8" Feinzahn-Umschaltknarre

10 3/8"



VIGOR No.	← L → mm	EAN 4047728+
V2304	198	023047

Reparatur-Satz
V3584, EAN 4047728035842



10 $\frac{3}{8}$ " 125 $\frac{1}{2}$ " Schiebestück/Adapter

10 $\frac{3}{8}$ " 125 $\frac{1}{2}$ "

VIGOR No.	mm	EAN 4047728+
V2116	40	021166



10 $\frac{3}{8}$ " 10 $\frac{3}{8}$ " Universalgelenk

10 $\frac{3}{8}$ " 10 $\frac{3}{8}$ "

VIGOR No.	mm	EAN 4047728+
V2118	50	021180



8 $\frac{5}{16}$ " 10 $\frac{3}{8}$ " Bit-Adapter

8 $\frac{5}{16}$ " 10 $\frac{3}{8}$ "

VIGOR No.	mm	EAN 4047728+
V2114	28	021142



6.3 $\frac{1}{4}$ " 10 $\frac{3}{8}$ " Adapter

6.3 $\frac{1}{4}$ " 10 $\frac{3}{8}$ "

VIGOR No.	mm	EAN 4047728+
V2071	27	020718



125 $\frac{1}{2}$ " 10 $\frac{3}{8}$ " Adapter

125 $\frac{1}{2}$ " 10 $\frac{3}{8}$ "

VIGOR No.	mm	EAN 4047728+
V2108	36	021081



10 $\frac{3}{8}$ " 10 $\frac{3}{8}$ " Bit-Adapter

10 $\frac{3}{8}$ " 10 $\frac{3}{8}$ "

VIGOR No.	mm	EAN 4047728+
V3652	30	036528



10 $\frac{3}{8}$ " 10 $\frac{3}{8}$ " Verlängerung

10 $\frac{3}{8}$ " 10 $\frac{3}{8}$ "

VIGOR No.	mm	EAN 4047728+
V2115	75	021159
V2616	125	026161
V2117	250	021173



10 $\frac{3}{8}$ " 10 $\frac{3}{8}$ " Schwenkbare Verlängerung

- Mit kugelförmigem, konischem Außenvierkant
- Zur Befähigung von Schraubverbindungen auf engem Raum und Umgehen von Störkanten

10 $\frac{3}{8}$ " 10 $\frac{3}{8}$ "

VIGOR No.	mm	EAN 4047728+
V4314	36	043144
V4315	75	043151
V4316	250	043168



125 1/2"

Steckschlüssel-Systeme



V2460, EAN 4047728024600

125 1/2" Steckschlüssel-Satz

25

125 1/2"



Einzelteilaufstellung ab Seite 66

X	Ausführung	SW mm / mm
18 x		10 · 11 · 12 · 13 · 14 · 15 · 16 · 17 · 18 · 19 · 20 · 21 · 22 · 23 · 24 · 27 · 30 · 32
2 x		16 · 21 mm
1 x		250 mm
1 x		125 mm
1 x		250 mm
1 x		75 mm
1 x		250 mm



V1898, EAN 4047728018982

125 1/2" Multiprofil Steckschlüssel-Satz

125 1/2"

Multiprofile

TORX® 4-kant Spline 6-kant Abgerundeter 6-kant Doppel-6-kant

17



Alle Einsätze für 6 Profile geeignet!



Einzelteilaufstellung ab Seite 66

X	Ausführung	SW mm
17 x		10 · 11 · 12 · 13 · 14 · 15 · 16 · 17 · 18 · 19 · 20 · 21 · 22 · 24 · 27 · 30 · 32 mm



V1917, EAN 4047728019170

12⁵ 1/2 TORX® Schraubendreher-Einsatz-Sortiment

12⁵ 1/2

32

Einzelteilaufistung Seite 68

	Ausführung	SW mm
10 x		T 20 · T 25 · T 27 · T 30 · T 40 · T 45 · T 50 · T 55 · T 60 · T 70
10 x		T 20 · T 25 · T 27 · T 30 · T 40 · T 45 · T 50 · T 55 · T 60 · T 70
6 x		T 40 · T 45 · T 50 · T 55 · T 60 · T 70
6 x		T 40 · T 45 · T 50 · T 55 · T 60 · T 70



V1918, EAN 4047728019187

12⁵ 1/2 Innenvielzahn Schraubendreher-Einsatz-Sortiment (XZN)

12⁵ 1/2

26

Einzelteilaufistung Seite 67

	Ausführung	SW mm
8 x		M 5 · M 6 · M 8 · M 9 · M 10 · M 12 · M 14 · M 16
7 x		M 5 · M 6 · M 8 · M 9 · M 10 · M 12 · M 14
7 x		M 5 · M 6 · M 8 · M 9 · M 10 · M 12 · M 14
4 x		M 8 · M 10 · M 12 · M 14

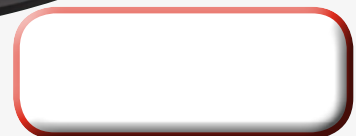

12⁵ 1/2

Steckschlüssel-Systeme



V1919, EAN 4047728019194

12⁵ 1/2 Innensechskant Schraubendreher-Einsatz-Sortiment

12⁵ 1/2



30

Einzelteilaufistung Seite 67

X	Ausführung	SW mm
9 x		5 · 6 · 7 · 8 · 10 · 12 · 14 · 17 · 19 mm
8 x		5 · 6 · 7 · 8 · 10 · 11 · 12 · 13 mm
7 x		5 · 6 · 7 · 8 · 10 · 12 · 14 mm
6 x		5 · 6 · 7 · 8 · 10 · 12 mm

V2201, EAN 4047728022019

12⁵ 1/2 RIBE Schraubendreher-Einsatz-Sortiment

12⁵ 1/2



32

Einzelteilaufistung Seite 68

X	Ausführung	SW mm
9 x		M 5 · M 6 · M 7 · M 8 · M 9 · M 10 · M 12 · M 13 · M 14
9 x		M 5 · M 6 · M 7 · M 8 · M 9 · M 10 · M 12 · M 13 · M 14
7 x		M 8 · M 9 · M 10 · M 10,3 · M 12 · M 13 · M 14
7 x		M 8 · M 9 · M 10 · M 10,3 · M 12 · M 13 · M 14



V2496, EAN 4047728024969

12⁵ 1/2 Schraubendreher-Einsatz-Sortiment

12⁵ 1/2



36

Einzelteilaufistung Seite 67 + 68

X	Ausführung	SW mm
8 x		M 5 · M 6 · M 8 · M 9 · M 10 · M 12 · M 14 · M 16
9 x		5 · 6 · 7 · 8 · 10 · 12 · 14 · 17 · 19 mm
9 x		M 5 · M 6 · M 7 · M 8 · M 9 · M 10 · M 12 · M 13 · M 14
10 x		T 20 · T 25 · T 27 · T 30 · T 40 · T 45 · T 50 · T 55 · T 60 · T 70



12⁵ 1/2 Spiralnutenausdreher-Einsatz-Sortiment

• Spezialprofil zum Lösen von Müttern mit rundgedrehten Köpfen

12⁵ 1/2



10

12⁵ 1/2



7

V2404, EAN 4047728024044

Einzelteilaufistung Seite 71

X	Ausführung	SW mm
9 x		10 · 11 · 12 · 13 · 14 · 15 · 16 · 17 · 19 mm



V3741, EAN 4047728037419

Einzelteilaufistung Seite 71

X	Ausführung	SW mm
6 x		21 · 22 · 24 · 27 · 30 · 32 mm



125 1/2

Steckschlüssel-Systeme



V4397, EAN 4047728043977

125 1/2 Kraft-Steckschlüssel-Einsatz-Sortiment, kurz

13

125 1/2

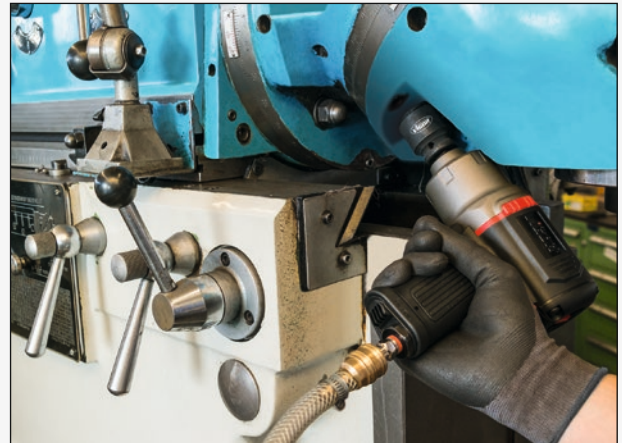

Einzelteilaufistung Seite 70

	Ausführung	SW mm
13 x		10 · 11 · 12 · 13 · 14 · 15 · 16 · 17 · 18 · 19 · 21 · 22 · 24 mm



V4408, EAN 4047728044080

125 1/2 Kraft-Steckschlüssel-Einsatz Sortiment, lang

13

125 1/2



Einzelteilaufistung Seite 70

	Ausführung	SW mm
13 x		10 · 11 · 12 · 13 · 14 · 15 · 16 · 17 · 18 · 19 · 21 · 22 · 24 mm



12⁵ 1/2 Steckschlüssel-Einsatz



VIGOR No.	SW mm	mm	EAN 4047728+
V2465	10	38	024655
V2598	11	38	025980
V2603	12	38	026031
V2599	13	38	025997
V2600	14	38	026000
V2561	15	38	025614
V2562	16	38	025621
V2563	17	38	025638
V2564	18	38	025645
V2565	19	38	025652
V2566	20	38	025669
V2567	21	38	025676
V2568	22	38	025683
V2569	23	38	025690
V2570	24	38	025706
V2571	27	42	025713
V2572	30	44	025720
V2574	32	44	025744

12⁵ 1/2 Steckschlüssel-Einsatz, lang



VIGOR No.	SW mm	mm	EAN 4047728+
V2579	10	77	025799
V2580	11	77	025805
V2581	12	77	025812
V2584	13	77	025843
V2585	14	77	025850
V2586	15	77	025867
V2587	16	77	025874
V2588	17	77	025881
V2589	18	77	025898
V2590	19	77	025904
V2591	22	77	025911

12⁵ 1/2 TORX® Steckschlüssel-Einsatz



VIGOR No.	SW mm	mm	EAN 4047728+
V2730	E 10	38	027304
V2731	E 11	38	027311
V2732	E 12	38	027328
V2733	E 14	38	027335
V2734	E 16	38	027342
V2196	E 18	38,2	021968
V2197	E 20	38,2	021975
V2735	E 22	38	027359
V2592	E 24	38	025928

12⁵ 1/2 Zündkerzen-Einsatz



VIGOR No.	SW mm	mm	EAN 4047728+
V2578	16	66	025782
V2582	21	66	025829

12⁵ 1/2 Feinzahn-Umschaltknarre



VIGOR No.	mm	EAN 4047728+
V1020	250	010207

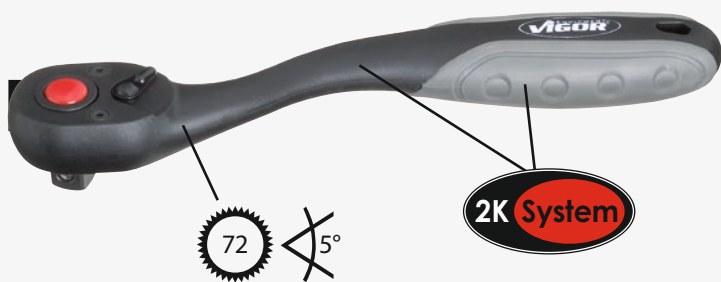

Multiprofil-Steckschlüssel Einsatz



VIGOR No.	SW mm	mm	EAN 4047728+
V1988	10	38,1	019880
V1989	11	38,1	019897
V1990	12	38,1	019903
V1991	13	38,1	019910
V1992	14	38,1	019927
V1993	15	38,1	019934
V1994	16	38,1	019941
V1995	17	38,1	019958
V1996	18	38,1	019965
V1997	19	38,1	019972
V1998	20	38,1	019989
V1999	21	38,1	019996
V2000	22	38,1	020008
V2001	24	40	020015
V2002	27	42	020022
V2003	30	45	020039
V2004	32	45	020046

Multiprofile

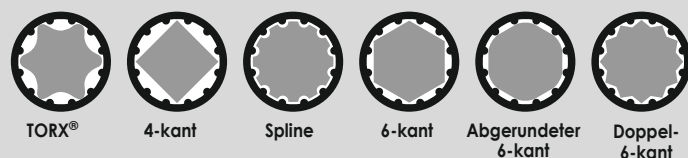

12⁵ 1/2"

Steckschlüssel-Systeme

**12⁵** 1/2" Innensechskant Schraubendreher-Einsatz ○

VIGOR No.	SW mm	← L → mm	EAN 4047728+
V2101	5	55	021012
V2102	6	55	021029
V2103	7	55	021036
V2104	8	55	021043
V2105	10	55	021050
V2106	12	55	021067
V2107	14	55	021074
V2069	17	55	020695
V2070	19	55	020701

12⁵ 1/2" Innensechskant Schraubendreher-Einsatz ○

VIGOR No.	SW mm	← L → mm	EAN 4047728+
V2072	5	100	020725
V2073	6	100	020732
V2074	7	100	020749
V2075	8	100	020756
V2076	10	100	020763
V2077	11	100	020770
V2078	12	100	020787
V2079	13	100	020794

12⁵ 1/2" Innensechskant Schraubendreher-Einsatz ○

VIGOR No.	SW mm	← L → mm	EAN 4047728+
V2080	5	140	020800
V2081	6	140	020817
V2082	7	140	020824
V2083	8	140	020831
V2084	10	140	020848
V2085	12	140	020855
V2086	14	140	020862

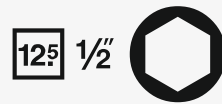
12⁵ 1/2" Innensechskant Schraubendreher-Einsatz ○

VIGOR No.	SW mm	← L → mm	EAN 4047728+
V2087	5	200	020879
V2088	6	200	020886
V2089	7	200	020893
V2090	8	200	020909
V2091	10	200	020916
V2092	12	200	020923

12⁵ 1/2" Innenvielzahn Schraubendreher-Einsatz (XZN) ○

VIGOR No.	SW mm	← L → mm	EAN 4047728+
V2094	M 5	55	020947
V2095	M 6	55	020954
V2096	M 8	55	020961
V2097	M 9	55	020978
V2098	M 10	55	020985
V2099	M 12	55	020992
V2065	M 14	55	020657
V2100	M 16	55	021005

12⁵ 1/2" Innenvielzahn Schraubendreher-Einsatz (XZN) ○

VIGOR No.	SW mm	← L → mm	EAN 4047728+
V2066	M 5	100	020664
V2068	M 6	100	020688
V2067	M 8	100	020671
V2113	M 9	100	021135
V2059	M 10	100	020596
V2060	M 12	100	020602
V2121	M 14	100	021210

12⁵ 1/2" Innenvielzahn Schraubendreher-Einsatz (XZN) ○

VIGOR No.	SW mm	← L → mm	EAN 4047728+
V2122	M 5	140	021227
V2124	M 6	140	021241
V2123	M 8	140	021234
V2126	M 9	140	021265
V2128	M 10	140	021289
V2129	M 12	140	021296
V2132	M 14	140	021326

12⁵ 1/2" Innenvielzahn Schraubendreher-Einsatz (XZN) ○

VIGOR No.	SW mm	← L → mm	EAN 4047728+
V2133	M 8	200	021333
V2134	M 10	200	021340
V2135	M 12	200	021357
V2137	M 14	200	021371

12⁵ 1/2 TORX® Schraubendreher-Einsatz



VIGOR No.	SW mm	mm	EAN 4047728+
V2151	T 20	55	021517
V2152	T 25	55	021524
V2153	T 27	55	021531
V2154	T 30	55	021548
V2155	T 40	55	021555
V2156	T 45	55	021562
V2157	T 50	55	021579
V2158	T 55	55	021586
V2159	T 60	55	021593
V2160	T 70	55	021609



12⁵ 1/2 TORX® Schraubendreher-Einsatz



VIGOR No.	SW mm	mm	EAN 4047728+
V2161	T 20	100	021616
V2162	T 25	100	021623
V2163	T 27	100	021630
V2165	T 30	100	021654
V2167	T 40	100	021678
V2168	T 45	100	021685
V2169	T 50	100	021692
V2170	T 55	100	021708
V2171	T 60	100	021715
V2172	T 70	100	021722



12⁵ 1/2 TORX® Schraubendreher-Einsatz



VIGOR No.	SW mm	mm	EAN 4047728+
V2173	T 40	140	021739
V2174	T 45	140	021746
V2175	T 50	140	021753
V2176	T 55	140	021760
V2177	T 60	140	021777
V2178	T 70	140	021784



12⁵ 1/2 TORX® Schraubendreher-Einsatz



VIGOR No.	SW mm	mm	EAN 4047728+
V2179	T 40	200	021791
V2180	T 45	200	021807
V2181	T 50	200	021814
V2182	T 55	200	021821
V2183	T 60	200	021838
V2184	T 70	200	021845



12⁵ 1/2 RIBE Schraubendreher-Einsatz



VIGOR No.	SW mm	mm	EAN 4047728+
V2202	M 5	55	022026
V2203	M 6	55	022033
V2204	M 7	55	022040
V2205	M 8	55	022057
V2206	M 9	55	022064
V2207	M 10	55	022071
V2208	M 12	55	022088
V2209	M 13	55	022095
V2210	M 14	55	022101



12⁵ 1/2 RIBE Schraubendreher-Einsatz



VIGOR No.	SW mm	mm	EAN 4047728+
V2211	M 5	100	022118
V2212	M 6	100	022125
V2213	M 7	100	022132
V2214	M 8	100	022149
V2215	M 9	100	022156
V2216	M 10	100	022163
V2217	M 12	100	022170
V2218	M 13	100	022187
V2219	M 14	100	022194



12⁵ 1/2 RIBE Schraubendreher-Einsatz



VIGOR No.	SW mm	mm	EAN 4047728+
V2220	M 8	140	022200
V2221	M 9	140	022217
V2222	M 10	140	022224
V2223	M 10,3	140	022231
V2224	M 12	140	022248
V2225	M 13	140	022255
V2226	M 14	140	022262



12⁵ 1/2 RIBE Schraubendreher-Einsatz



VIGOR No.	SW mm	mm	EAN 4047728+
V2227	M 8	200	022279
V2228	M 9	200	022286
V2229	M 10	200	022293
V2230	M 10,3	200	022309
V2231	M 12	200	022316
V2232	M 13	200	022323
V2233	M 14	200	022330



125 1/2

Steckschlüssel-Systeme



125 1/2 TORX® Schraubendreher-Einsatz



VIGOR No.	SW mm	mm	EAN 4047728+
V2200	T 55 H	55	022002



125 1/2 Gleitgriff

125 1/2

VIGOR No.	mm	EAN 4047728+
V2573	250	025737



125 1/2 10 3/8 Gleitstück

125 1/2 10 3/8

VIGOR No.	mm	EAN 4047728+
V2667	43,7	026673



125 1/2 125 1/2 Universalgelenk

125 1/2 125 1/2

VIGOR No.	mm	EAN 4047728+
V2575	75	025751



10 3/8 125 1/2 Adapter

10 3/8 125 1/2

VIGOR No.	mm	EAN 4047728+
V2109	36	021098



20 3/4 125 1/2 Adapter

20 3/4 125 1/2

VIGOR No.	mm	EAN 4047728+
V2110	46	021104



125 1/2 Bit-Adapter auf 8 5/16

8 5/16 125 1/2

VIGOR No.	mm	EAN 4047728+
V2647	37	026475



125 1/2 LED-Verlängerung

125 1/2

VIGOR No.	mm	EAN 4047728+
V1131	60	011310



Inkl. 1,5 V (LR 44) – 180 mAh

125 1/2 125 1/2 Verlängerung

125 1/2 125 1/2

VIGOR No.	mm	EAN 4047728+
V2576	125	025768
V2577	250	025775
V4398	750	043984



125 1/2 125 1/2 Schwenkbare Verlängerung

- Mit kugelförmigem, konischem Außenvierkant
- Zur Befestigung von Schraubverbindungen auf engem Raum und Umgehen von Störkanten



125 1/2 125 1/2

VIGOR No.	mm	EAN 4047728+
V4317	50	043175
V4318	75	043182
V4319	250	043199



12⁵ 1/2 Kraft-Steckschlüssel-Einsatz, kurz

- Zur Maschinenbetätigung geeignet
- Oberfläche phosphatiert

12⁵ 1/2



VIGOR No.	SW mm	EAN 4047728+
V4345	10	043458
V4386	11	043861
V4387	12	043878
V4388	13	043885
V4389	14	043892
V4390	15	043908
V4391	16	043915
V4392	17	043922
V4462	18	044622
V4291	19	042918
V4394	21	043946
V4395	22	043953
V4396	24	043960



12⁵ 1/2 Kraft-Steckschlüssel-Einsatz, lang

- Zur Maschinenbetätigung geeignet
- Oberfläche phosphatiert

12⁵ 1/2



VIGOR No.	SW mm	EAN 4047728+
V4376	10	043762
V4377	11	043779
V4378	12	043786
V4379	13	043793
V4380	14	043809
V4401	15	044011
V4402	16	044028
V4403	17	044035
V4463	18	044639
V4404	19	044042
V4405	21	044059
V4406	22	044066
V4407	24	044073



12⁵ 1/2"

Steckschlüssel-Systeme



12⁵ 1/2" Spiralnutenausdreher-Einsatz

- Spezialprofil zum Lösen von Muttern mit rundgedrehten Köpfen

12⁵ 1/2" 



VIGOR No.	SW mm	L mm	EAN 4047728+
V2405	10	34	024051
V2402	11	34	024020
V2406	12	34	024068
V2407	13	34	024075
V2401	14	34	024013
V2408	15	34	024082
V2403	16	34	024037
V2409	17	34	024099
V2410	19	34	024105
V3742	21	34	037426
V3743	22	34	037433
V3744	24	34	037440
V3745	27	34	037457
V3746	30	34	037464
V3747	32	34	037471

V3737, EAN 4047728037372

Schraubenausdreher-Satz

- Mit 6-kant-Antrieb SW 13 mm
- Leicht konisch zulaufende Spirale
- Gut geeignet für abgerissene Schrauben und Stehbolzen
- Kontereffekt und Aufspreizbegrenzung durch Bund gewährleistet

Inhalt:

- Ausdreher 3,2 mm = 1/8" · 4,8 mm = 3/16" · 6,3 mm = 1/4" · 10 mm = 3/8" · 12,5 mm = 1/2"
- Ausdreher 3 · 4 · 5 · 5,5 · 6 · 8 · 10 · 11 · 12 · 14 mm



15

Extra kurze Ausführung

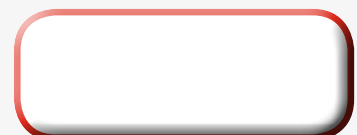

V2318, EAN 4047728023184

20 3/4" Steckschlüssel-Satz



20 3/4"

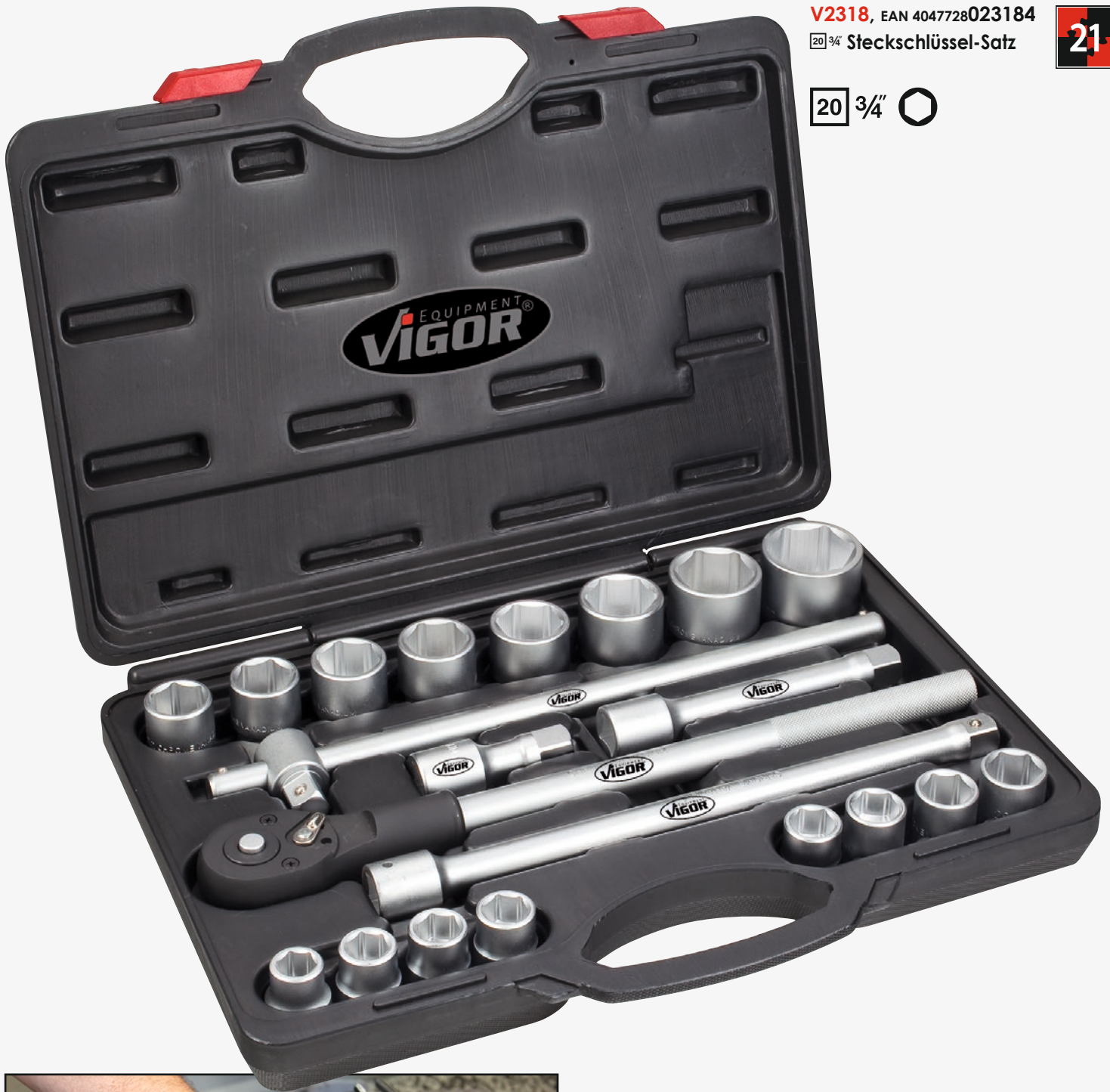

Einzelteilaufstellung Seite 73

X	Ausführung	SW mm / mm
16 x		19 · 21 · 22 · 23 · 24 · 26 · 27 · 28 · 30 · 32 · 34 · 36 · 38 · 41 · 46 · 50
1 x	20 3/4"	500 mm
1 x	20 3/4"	100 mm
2 x	20 3/4"	200 · 400 mm
1 x	20 3/4"	450 mm



20 3/4"

Steckschlüssel-Systeme



20 3/4" Steckschlüssel-Einsatz O



VIGOR No.	SW mm	l mm	EAN 4047728+
V2323	19	50	023238
V2324	21	50	023245
V2325	22	50	023252
V2326	23	50	023269
V2327	24	50	023276
V2328	26	50	023283
V2329	27	52	023290
V2256	28	52	022569
V2330	30	54	023306
V2331	32	56	023313
V2332	34	58	023320
V2333	36	58	023337
V2334	38	60	023344
V2337	41	64	023375
V2336	46	68	023368
V2335	50	68	023351

12 1/2 20 3/4" Adapter

12 1/2 20 3/4"

VIGOR No.	l mm	EAN 4047728+
V2111	50	021111



20 3/4" 20 3/4" Verlängerung

20 3/4" 20 3/4"

VIGOR No.	l mm	EAN 4047728+
V2320	100	023207
V2321	200	023214
V2317	400	023177



20 3/4" Gleitgriff

20 3/4"

VIGOR No.	l mm	EAN 4047728+
V2322	450	023221



20 3/4" Umschaltknarre

20 3/4"

VIGOR No.	l mm	EAN 4047728+
V2319	500	023191



V3278, EAN 4047728032780

25 1" Steckschlüssel-Satz ○



25 1" ○

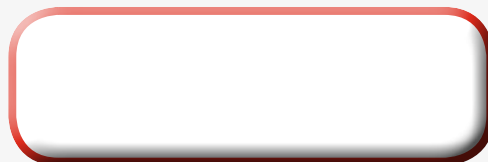

Einzelteilaufistung Seite 75

X	Ausführung	■	SW mm / mm
6 x		25 1"	50 · 55 · 60 · 65 · 70 · 80 mm
2 x		25 1"	200 · 400 mm
1 x		25 1"	170 mm
1 x		25 1"	500 mm
1 x		25 1"	—



25 1"

Steckschlüssel-Systeme



25 1" Doppel-Sechskant Steckschlüssel-Einsatz



VIGOR No.	SW mm	mm	EAN 4047728+
V3375	50	75	033756
V3376	55	80	033763
V3377	60	85	033770
V3378	65	87	033787
V3379	70	93	033794
V3380	80	103	033800

25 1" Gleitstück

25 1"

VIGOR No.	mm	EAN 4047728+
V3373	50	033732

25 1" 25 1" Verlängerung

25 1" 25 1"

VIGOR No.	mm	EAN 4047728+
V3280	200	032803
V3371	400	033718



25 1" Gleitgriff

25 1"

VIGOR No.	mm	EAN 4047728+
V3374	500	033749



25 1" Umschaltknarre

25 1"

VIGOR No.	mm	EAN 4047728+
V3372	170	033725





Steckschlüssel-Systeme



V3277, EAN 4047728032773

6.3 1/4 10 3/8 125 1/2 Steckschlüssel-Satz
216 tlg. Steckschlüssel-Sortiment

216

6.3 1/4 10 3/8 125 1/2

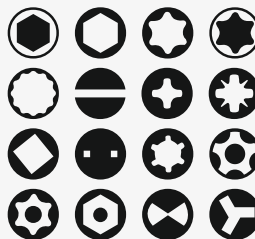

Einzelteilaufstellung ab Seite 54

X	Ausführung	■	SW / L mm / mm
12 x		—	8 · 9 · 10 · 11 · 12 · 13 · 14 15 · 17 · 19 · 22 · 24 mm
13 x		6.3 1/4	4 · 4,5 · 5 · 5,5 · 6 · 7 · 8 · 9 · 10 · 11 · 12 · 13 · 14 mm
7 x		6.3 1/4	4 · 5 · 6 · 7 · 8 · 9 · 10 mm
5 x		6.3 1/4	E 4 · E 5 · E 6 · E 7 · E 8
4 x		6.3 1/4	3 · 4 · 5 · 6 mm
4 x		6.3 1/4	0,8x4 · 1x5,5 · 1,2x6,5 · 1,2x7 mm
3 x		6.3 1/4	PH 0 · PH 1 · PH 2
3 x		6.3 1/4	PZ 0 · PZ 1 · PZ 2
8 x		6.3 1/4	T 8 · T 9 · T 10 · T 15 · T 20 · T 25 · T 27 · T 30
8 x		6.3 1/4	T 8 H · T 9 H · T 10 H · T 15 H · T 20 H · T 25 H · T 27 H · T 30 H
2 x		6.3 1/4	50 100 mm
1 x		6.3 1/4	150 mm
1 x		6.3 1/4	205 mm
1 x		6.3 1/4	150 mm
1 x		6.3 1/4	110 mm
1 x		6.3 1/4	40 mm
1 x		6.3 1/4	30 mm
7 x		6.3 1/4	1,27 · 1,5 · 2 · 2,5 · 3 · 4 · 5 mm
1 x		10 3/8	18 mm
1 x		10 3/8	198 mm
2 x		10 3/8	30 · 56 mm
1 x		10 3/8	30 mm
6 x		10 3/8	E 10 · E 11 · E 12 · E 14 · E 16 · E 18
10 x		10 3/8	10 · 11 · 12 · 13 · 14 · 15 · 16 · 17 · 18 · 19 mm
6 x		10 3/8	10 · 11 · 12 · 13 · 14 · 15 mm
1 x		10 3/8	125 mm
1 x		125 1/2	—
14 x		125 1/2	13 · 14 · 15 · 16 · 17 · 18 · 19 · 20 · 21 · 22 · 24 · 27 · 30 · 32 mm

X	Ausführung	■	SW / L mm / mm
5 x		125 1/2	16 · 17 · 18 · 19 · 22 mm
3 x		125 1/2	E 20 · E 22 · E 24
1 x		125 1/2	T 70
1 x		125 1/2	14 mm
2 x		125 1/2	16 · 21 mm
1 x		125 1/2	75 mm
2 x		125 1/2	125 · 250 mm
1 x		125 1/2	250 mm
1 x		125 1/2	—
3 x		6.3 1/4	M 5 · M 6 · M 8
6 x		6.3 1/4	2 · 2,5 · 3 · 4 · 5 · 6 mm
3 x		6.3 1/4	T 5 · T 6 · T 7
1 x		6.3 1/4	T 7 H
5 x		6.3 1/4	M 5 · M 6 · M 7 · M 8 · M 9
8 x		6.3 1/4	T 10 H · T 15 H · T 20 H · T 25 H · T 27 H · T 30 H · T 40 H · T 45 H
4 x		6.3 1/4	0 · 1 · 2 · 3 mm
3 x		6.3 1/4	6 · 8 · 10 mm
4 x		6.3 1/4	1 · 2 · 3 · 4 mm
3 x		6.3 1/4	1 · 2 · 3 mm
4 x		6.3 1/4	4 · 6 · 8 · 10 mm
4 x		8 9/16	7 · 8 · 10 · 12 mm
3 x		8 9/16	8 · 10 · 12 mm
3 x		8 9/16	PH 2 · PH 3 · PH 4
3 x		8 9/16	PZ 2 · PZ 3 · PZ 4
5 x		8 9/16	T 40 · T 45 · T 50 · T 55 · T 60
5 x		8 9/16	T 40 H · T 45 H · T 50 H · T 55 H · T 60 H
4 x		8 9/16	M 10 · M 11 · M 12 · M 13
2 x		8 9/16	M 10 · M 12
1 x		8 9/16	50 mm

Steckschlüssel-Systeme



V2461, EAN 4047728024617

6.3 1/4 10 3/8 12.5 1/2 Steckschlüssel-Satz

172

6.3 1/4 10 3/8 12.5 1/2



Einzelteilaufstellung ab Seite 54

X	Ausführung	■	SW / L mm / mm
13 x		6.3 1/4	4 · 4,5 · 5 · 5,5 · 6 · 7 · 8 · 9 · 10 · 11 · 12 · 13 · 14 mm
7 x		6.3 1/4	4 · 5 · 6 · 7 · 8 · 9 · 10 mm
5 x		6.3 1/4	E 4 · E 5 · E 6 · E 7 · E 8
4 x		6.3 1/4	3 · 4 · 5 · 6 mm
4 x		6.3 1/4	0,8x4 · 1x5 · 1,2x6,5 · 1,2x7 mm
3 x		6.3 1/4	PH 0 · PH 1 · PH 2
3 x		6.3 1/4	PZ 0 · PZ 1 · PZ 2
8 x		6.3 1/4	T 8 · T 9 · T 10 · T 15 · T 20 · T 25 · T 27 · T 30
8 x		6.3 1/4	T 8 H · T 9 H · T 10 H · T 15 H · T 20 H · T 25 H · T 27 H · T 30 H
1 x		6.3 1/4	50 mm
1 x		6.3 1/4	100 mm
1 x		6.3 1/4	150 mm
1 x		6.3 1/4	150 mm
1 x		6.3 1/4	110 mm
1 x		6.3 1/4	38 mm
1 x		6.3 3/8	30 mm
3 x		6.3 3/8	5 · 6 · 8 mm
5 x		6.3 3/8	5 · 6 · 7 · 8 · 9 mm
3 x		6.3 3/8	T 5 · T 6 · T 7
9 x		6.3 3/8	T 7 H · T 10 H · T 15 H · T 20 H · T 25 H · T 27 H · T 30 H · T 40 H · T 45 H
10 x		10 3/8	10 · 11 · 12 · 13 · 14 · 15 · 16 · 17 · 18 · 19 mm
6 x		10 3/8	10 · 11 · 12 · 13 · 14 · 15 mm

X	Ausführung	■	SW / L mm / mm
1 x		10 3/8	18 mm
6 x		10 3/8	E 10 · E 11 · E 12 · E 14 · E 16 · E 18
1 x		10 3/8	—
1 x		10 3/8	198 mm
1 x		10 3/8	56 mm
1 x		10 3/8	30 mm
3 x		8 3/8	8 · 10 · 12 mm
5 x		8 3/8	7 · 8 · 10 · 12 · 14 mm
2 x		8 3/8	PH 3 · PH 4
2 x		8 3/8	PZ 3 · PZ 4
6 x		8 3/8	T 40 · T 45 · T 50 · T 55 · T 60 · T 70
6 x		8 3/8	T 40 H · T 45 H · T 50 H · T 55 H · T 60 H · T 70 H
1 x		10 3/8	125 mm
17 x		12.5 1/2	10 · 11 · 12 · 13 · 14 · 15 · 16 · 17 · 18 · 19 · 20 · 21 · 22 · 24 · 27 · 30 · 32 mm
5 x		12.5 1/2	16 · 17 · 18 · 19 · 22 mm
2 x		12.5 1/2	E 20 · E 22
2 x		12.5 1/2	16 · 21 mm
1 x		12.5 1/2	75 mm
2 x		12.5 1/2	125 · 250 mm
1 x		10 3/8	—
1 x		12.5 1/2	—
1 x		12.5 1/2	258 mm
7 x		12.5 1/2	1,27 · 1,5 · 2 · 2,5 · 3 · 4 · 5 mm



Steckschlüssel-Systeme



V1706, EAN 4047728017060
Steckschlüssel-Satz

94

6.3 1/4 12.5 1/2 8 5/16



Einzelteilaufstellung ab Seite 54

X	Ausführung	■	SW mm / — mm
13 x		6.3 1/4	4 · 4,5 · 5 · 5,5 · 6 · 7 · 8 · 9 · 10 · 11 · 12 · 13 · 14 mm
8 x		6.3 1/4	6 · 7 · 8 · 9 · 10 · 11 · 12 · 13 mm
4 x		6.3 1/4	3 · 4 · 5 · 6 mm
3 x		6.3 1/4	0,8x4 · 1x5,5 · 1,2x7 mm
2 x		6.3 1/4	PH 1 · PH 2
2 x		6.3 1/4	PZ 1 · PZ 2
6 x		6.3 1/4	T 8 · T 10 · T 15 · T 20 · T 25 · T 30
1 x		6.3 1/4	50 mm
2 x		6.3 1/4	100 · 145 mm
1 x		—	150 mm
1 x		—	150 mm
1 x		—	110 mm
1 x		6.3 1/4	38 mm
1 x		6.3 1/4	30 mm

X	Ausführung	■	SW mm / — mm
18 x		12.5 1/2	10 · 11 · 12 · 13 · 14 · 15 · 16 · 17 · 18 · 19 · 20 · 21 · 22 · 23 · 24 · 27 · 30 · 32 mm
4 x		12.5 1/2	14 · 15 · 17 · 19 mm
2 x		12.5 1/2	16 · 21 mm
1 x		12.5 1/2	75 mm
2 x		12.5 1/2	125 · 250 mm
1 x		10 9/16	—
1 x		8 5/16	12.5 1/2
1 x		12.5 1/2	258 mm
3 x		8 5/16	8 · 10 · 12 mm
4 x		8 5/16	8 · 10 · 12 · 14 mm
2 x		8 5/16	PH 3 · PH 4
2 x		8 5/16	PZ 3 · PZ 4
4 x		8 5/16	T 40 · T 45 · T 50 · T 55
3 x		—	1,5 · 2 · 2,5 mm

Steckschlüssel-Systeme



V2687, EAN 4047728026871
TORX® Steckschlüssel-Satz

28

6.3 1/4 10 3/8 12.5 1/2



X	Ausführung	■	SW mm
7 x		6.3 1/4	E 4 · E 5 · E 6 · E 7 · E 8 · E 10 · E 11
12 x		10 3/8	E 4 · E 5 · E 6 · E 7 · E 8 · E 10 · E 11 · E 12 · E 14 · E 16 · E 18 · E 20

X	Ausführung	■	SW mm
9 x		12.5 1/2	E 10 · E 11 · E 12 · E 14 · E 16 · E 18 · E 20 · E 22 · E 24

Einzelteilaufistung ab Seite 54

V1781, EAN 4047728017817
TORX® Steckschlüssel-Satz

34

6.3 1/4 10 3/8 12.5 1/2

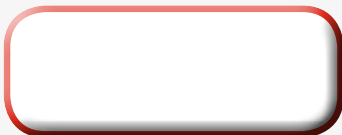

X	Ausführung	■	SW mm
5 x		6.3 1/4	E 4 · E 5 · E 6 · E 7 · E 8
7 x		6.3 1/4	T 8 · T 10 · T 15 · T 20 · T 25 · T 27 · T 30
6 x		6.3 1/4	T 10 H · T 15 H · T 20 H · T 25 H · T 27 H · T 30 H
4 x		10 3/8	E 10 · E 12 · E 14 · E 16
4 x		10 3/8	T 40 · T 45 · T 47 · T 50

X	Ausführung	■	SW mm
3 x		10 3/8	T 40 H · T 45 H · T 50 H
2 x		12.5 1/2	E 18 · E 20
2 x		12.5 1/2	T 55 · T 60
1 x		12.5 1/2	T 55 H

Einzelteilaufistung ab Seite 54

V1039, EAN 4047728010399

Feinzahn-Umschaltknarren-Satz

• DIN 3122 / ISO 3315

6.3 1/4" **12.5** 1/2"

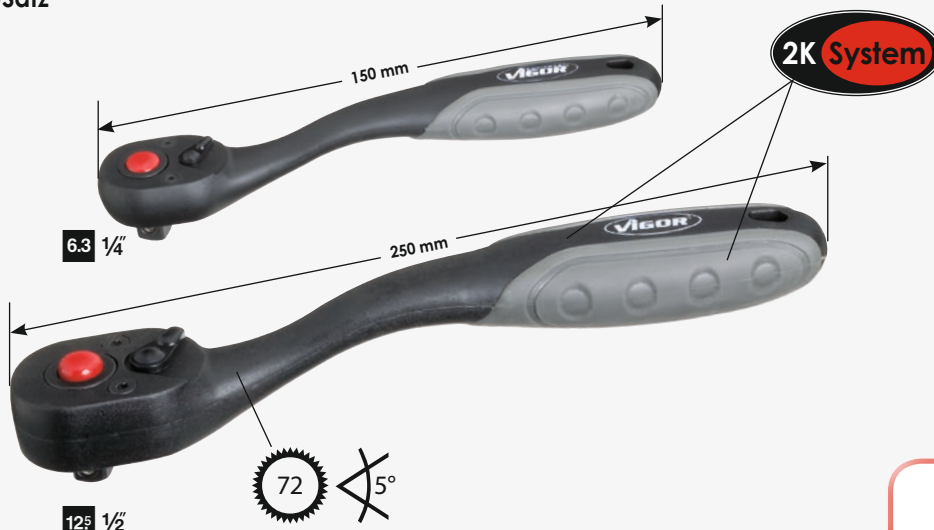

Einzelteilaufistung ab Seite 55



V3081, EAN 4047728030816

Feinzahn-Umschaltknarren-Satz

• DIN 3122 / ISO 3315

6.3 1/4" **10** 3/8" **12.5** 1/2"



Einzelteilaufistung ab Seite 55



V1293, EAN 4047728012935

Adapter-Satz



Einzelteilaufistung ab Seite 56

	Ausführung	
6 x		6.3 1/4" - 10 3/8" 10 3/8" - 6.3 1/4" 10 3/8" - 12.5 1/2" 12.5 1/2" - 10 3/8" 12.5 1/2" - 20 3/4" 20 3/4" - 12.5 1/2"



Schraubenschlüssel



V4194, EAN 4047728**041942**

Doppel-Gelenkschlüssel-Satz

• Anwendbar unter beengten Platzverhältnissen



X	Ausführung	SW mm
7 x		8x9 · 10x11 · 12x13 · 14x15 16x17 · 18x19 · 21x22 mm

Doppel-Gelenkschlüssel



VIGOR No.	SW mm	l mm	L1 mm	EAN 4047728+
V4204	8x9	183	27	042048
V4203	10x11	200	28	042031
V4205	12x13	216	34	042055
V4206	14x15	240	38	042062
V4207	16x17	257	42	042079
V4208	18x19	271	44	042086
V4209	21x22	304	59	042093

V1461, EAN 4047728**014618**

Doppel-Maulschlüssel-Satz

• DIN 3110



X	Ausführung	SW mm
12 x		6x7 · 8x9 · 10x11 · 12x13 · 14x15 · 16x17 · 18x19 20x22 · 21x23 · 24x27 · 25x28 · 30x32 mm



Doppel-Maulschlüssel

• DIN 3110

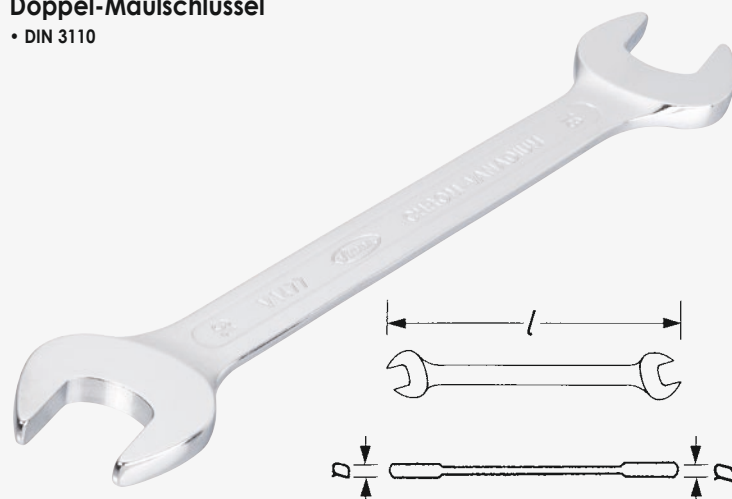

VIGOR No.	SW mm	l mm	a mm	EAN 4047728+
V1471	6x7	105	3,4	014717
V1472	8x9	115	3,8	014724
V1473	10x11	130	4,4	014731
V1474	12x13	142	5	014748
V1475	14x15	152	5,6	014755
V1476	16x17	165	6,2	014762
V1669	16x18	205	6,2	016698
V1671	17x19	220	6,8	016711
V1477	18x19	175	6,8	014779
V1478	20x22	190	7,2	014786
V1479	21x23	205	7,8	014793
V1672	22x24	248	7,8	016728
V1480	24x27	215	8,4	014809
V1481	25x28	240	9	014816
V1482	30x32	260	9,6	014823

V4472, EAN 4047728**044721**

Ring-Maulschlüssel-Satz

- Lange Ausführung
- 15° gekröpfter Ringschlüssel
- Verchromt, poliert



Neu: Jetzt mit SW 16 + 18

X	Ausführung	SW mm
15 x		6 · 7 · 8 · 9 · 10 · 11 · 12 · 13 · 14 · 15 · 16 · 17 · 18 · 19 · 22 mm



V4473, EAN 4047728**044738**

Ring-Maulschlüssel-Satz

- Lange Ausführung
- 15° gekröpfter Ringschlüssel
- Verchromt, poliert



X	Ausführung	SW mm
22 x		6 · 7 · 8 · 9 · 10 · 11 · 12 · 13 · 14 · 15 · 16 · 17 · 18 · 19 · 20 · 21 · 22 · 24 · 27 · 30 · 32 · 36 mm



Ring-Maulschlüssel

• DIN 3113 / ISO 7738



VIGOR No.	SW mm	L mm	a1 mm	a2 mm	EAN 4047728+
V1040	6	105	5,2	3,5	010405
V1041	7	115	6,2	3,8	010412
V1042	8	130	6,6	4,3	010429

VIGOR No.	SW mm	L mm	a1 mm	a2 mm	EAN 4047728+
V1043	9	142	7	4,3	010436
V1044	10	152	7,8	4,6	010443
V1045	11	165	8,1	4,8	010450
V1047	12	175	9,1	5,3	010474
V1048	13	190	9,6	5,6	010481
V1049	14	205	10,2	5,9	010498
V1050	15	215	10,9	6,3	010504
V1680	16	227	11,6	6,5	016803
V1051	17	240	11,7	6,9	010511
V1673	18	251	12,8	7,1	016735
V1052	19	260	12,3	8	010528
V4197	20	275	13,2	7,7	041973
V4198	21	288	13,3	8,1	041980
V1053	22	295	14,8	9	010535
V1674	24	330	15,8	9,6	016742
V1676	27	360	17,1	10	016766
V1677	30	390	18,5	11	016773
V1678	32	420	20,1	12	016780
V1679	36	450	21,5	13	016797

Schraubenschlüssel



V1524, EAN 4047728015240
Doppel-Ringschlüssel-Sortiment
 • DIN 838 / ISO 10104

12



	Ausführung	SW mm
12 x		6x7 · 8x9 · 10x11 · 12x13 · 14x15 · 16x17 · 18x19 · 20x22 · 21x23 · 24x27 · 25x28 · 30x32 mm

Doppel-Ringschlüssel

• DIN 838 / ISO 10104

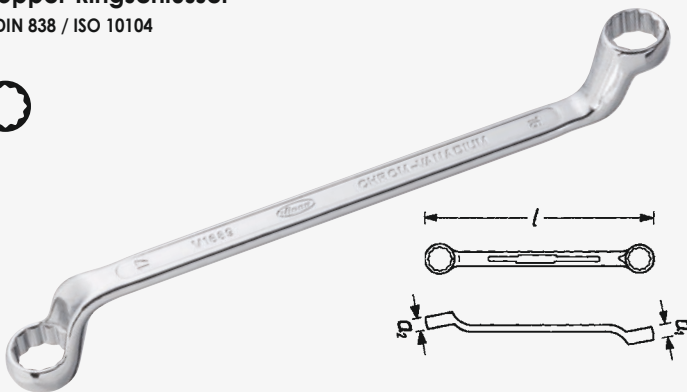

VIGOR No.	SW mm	L mm	a1 mm	a2 mm	EAN 4047728+
V1684	6x7	176	6,3	5,7	016841
V1685	8x9	190,5	7,7	6,7	016858
V1686	10x11	205	9,2	8,6	016865
V1687	12x13	220,5	9,9	9,5	016872
V1688	14x15	236	10,8	10,2	016889
V1689	16x17	250	12	11,4	016896
V1690	18x19	271	12,8	12,4	016902
V1691	20x22	291	14	13,2	016919
V1692	21x23	310,5	14,2	13,6	016926
V1693	24x27	331	15,6	14,4	016933
V1694	25x28	350	15,6	14,6	016940
V1695	30x32	371	16,9	16,4	016957

V2815, EAN 4047728028158

Ratschen-Ring-Maulschlüssel-Satz, kurze Ausführung

• Mit Rolltasche

5



	Ausführung	SW mm
5 x		8 · 10 · 13 · 17 · 19 mm



V2821, EAN 4047728028219

Ratschen-Ring-Maulschlüssel-Satz, kurze Ausführung

• Mit Rolltasche

12



	Ausführung	SW mm
12 x		8 · 9 · 10 · 11 · 12 · 13 · 14 · 15 · 16 · 17 · 18 · 19 mm



Ratschen-Ring-Maulschlüssel, kurze Ausführung



VIGOR No.	SW mm	l mm	a1 mm	a2 mm	EAN 4047728+
V2822	8	89	7,4	4,9	028226
V2823	9	93	7,5	5,2	028233
V2824	10	97	8,5	5,5	028240
V2825	11	102	8,4	6,1	028257
V2826	12	106	8,5	6,3	028264
V2827	13	110	8,4	6,7	028271
V2828	14	114	8,4	7	028288
V2829	15	120	8,4	7,4	028295
V2830	16	122	10	7,7	028301
V2831	17	126	10	7,7	028318
V2832	18	131	11,5	8,4	028325
V2833	19	136	11,5	8,6	028332

Schraubenschlüssel



V2820, EAN 4047728028202
Ratschen-Ring-Maulschlüssel-Satz, lange Ausführung
 • Mit Rolltasche

5



	Ausführung	SW mm
5 x		8 · 10 · 13 · 17 · 19 mm



V1031, EAN 4047728010313
Ratschen-Ring-Maulschlüssel-Satz, lange Ausführung
 • Mit Rolltasche

12



	Ausführung	SW mm
12 x		8 · 9 · 10 · 11 · 12 · 13 · 14 · 15 · 16 · 17 · 18 · 19 mm



Ratschen-Ring-Maulschlüssel, lange Ausführung



VIGOR No.	SW mm	L mm	a1 mm	a2 mm	EAN 4047728+
V3635	6	135	4,6	7,4	036351
V3636	7	144	4,7	7,4	036368
V1008	8	140	4,7	7,4	010085
V1009	9	151	5,3	7,4	010092
V1010	10	160	5,7	8,4	010108
V1021	11	165	6,1	8,4	010214
V1022	12	170	6,4	8,4	010221
V1023	13	177	6,6	8,4	010238
V1025	14	192	7,3	8,4	010252
V1026	15	200	7,5	8,4	010269
V1027	16	210	7,7	10	010276
V1028	17	225	7,9	10	010283
V1029	18	235	8,4	11,5	010290
V1030	19	245	8,7	11,5	010306

V2819, EAN 4047728028196

Gelenk-Ratschen-Ring-Maulschlüssel-Satz

• Mit Rolltasche



	Ausführung	SW mm
5 x		8 · 10 · 13 · 17 · 19 mm



V2818, EAN 4047728028189

Gelenk-Ratschen-Ring-Maulschlüssel-Satz

• Mit Rolltasche



	Ausführung	SW mm
12 x		8 · 9 · 10 · 11 · 12 · 13 · 14 · 15 · 16 · 17 · 18 · 19 mm



Gelenk-Ratschen-Ring-Maulschlüssel



VIGOR No.	SW mm	l mm	a1 mm	a2 mm	EAN 4047728+
V2804	8	143	7,4	5	028042
V2805	9	150	7,4	5,3	028059
V2806	10	158	8,4	5,9	028066
V2807	11	165	8,4	6,1	028073
V2808	12	170	8,4	6,4	028080
V2809	13	182	8,4	6,7	028097
V2810	14	190	8,4	7,4	028103
V2811	15	200	8,5	7,6	028110
V2812	16	215	9,9	7,6	028127
V2813	17	228	10	8	028134
V2814	18	241	11,1	8,2	028141
V2817	19	250	11,5	8,7	028172

Schraubenschlüssel



V3607, EAN 4047728036078

Doppel-Ratschen-Ringschlüssel

4 in 1

VIGOR No.	SW mm	L mm	a1 mm	a2 mm	EAN 4047728+
V3607	8x12 10x13	220	12,5	14,5	036078

V3608, EAN 4047728036085

Doppel-Ratschen-Ringschlüssel

4 in 1

VIGOR No.	SW mm	L mm	a1 mm	a2 mm	EAN 4047728+
V3608	9x11 15x16	220	14	16,5	036085

V2705, EAN 4047728027052

Doppel-Ratschen-Ringschlüssel

4 in 1

VIGOR No.	SW mm	L mm	a1 mm	a2 mm	EAN 4047728+
V2705	10x17 13x19	220	20	17	027052

V1424, EAN 4047728014243
Doppel-Ratschen-Ringschlüssel-Satz



1 Schlüssel für 6 Profile!



X	Ausführung	SW mm
6 x		8x9 · 10x11 · 12x13 · 14x15 · 16x18 · 17x19 mm

Doppel-Ratschen-Ringschlüssel

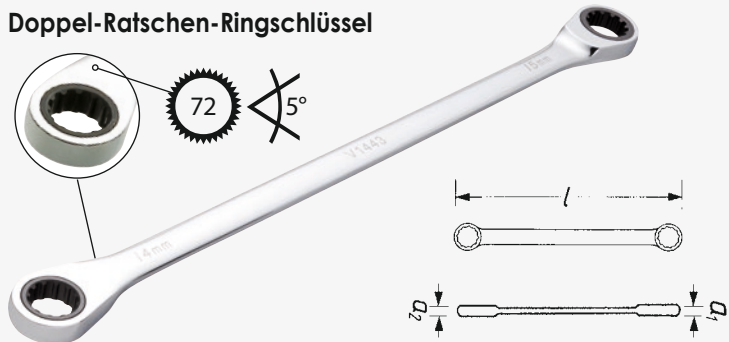

VIGOR No.	SW mm	l mm	a1 mm	a2 mm	EAN 4047728+
V1430	8x9	235	7,4	7,4	014304
V1441	10x11	270	8,4	8,4	014410
V1442	12x13	300	8,4	8,4	014427
V1443	14x15	330	8,4	8,4	014434
V1444	16x18	375	10	11,5	014441
V1445	17x19	405	10	11,5	014458

Multiprofile

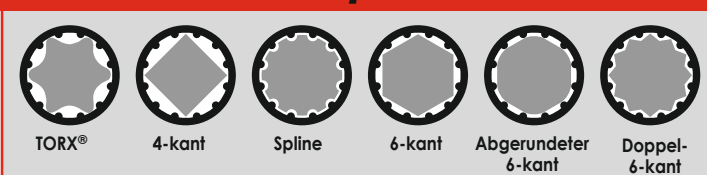

V1364, EAN 4047728013642
Aluminium-Ratschen-Ringschlüssel-Satz
 • Mit Rolltasche



X	Ausführung	SW mm
4 x		10 · 13 · 17 · 19 mm

Aluminium-Ratschen-Ringschlüssel

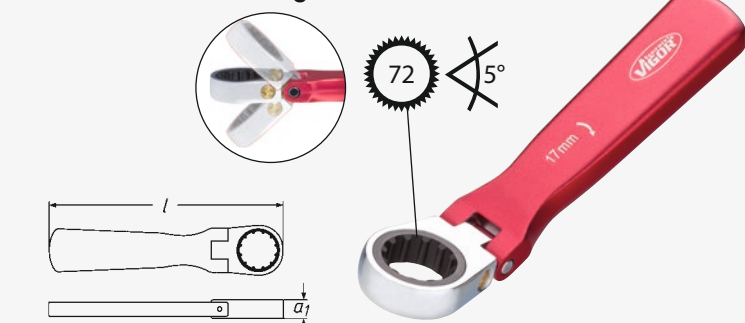

VIGOR No.	SW mm	l mm	a1 mm	EAN 4047728+
V1400	8	89,8	7,4	014007
V1411	10	103,3	8,4	014113
V1412	12	116,2	8,4	014120
V1414	13	117	8,4	014144
V1415	14	129,7	8,4	014151
V1416	15	131,4	8,4	014168
V1417	16	142,5	8,4	014175
V1418	17	144	10	014182
V1419	18	156,2	11,4	014199
V1420	19	158,8	11,4	014205

Schraubendreher und Bits



V1637, EAN 4047728016377

Schraubendreher-Satz

• Nach DIN/ISO gefertigt



X	Ausführung	Größe mm
4 x		3 · 4 · 5,5 · 6,5 mm
3 x		PH 0 · PH 1 · PH 2



Schlitz-Schraubendreher

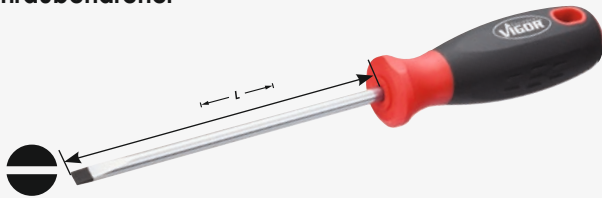

VIGOR No.	SW mm	L mm	EAN 4047728+
V1698	0,5x3	75	016988
V1699	0,8x4	80	016995
V1700	1,0x5,5	125	017008
V1701	1,2x6,5	150	017015
V3613	1,2x8	150	036139
V3609	1,6x10	175	036092

Kreuzschlitz-Schraubendreher



VIGOR No.	SW mm	L mm	EAN 4047728+
V1702	PH 0	75	017022
V1703	PH 1	80	017039
V1704	PH 2	100	017046
V3610	PH 3	150	036108

V3562, EAN 4047728035620

Schraubendreher-Satz mit Schlagkappe

• Nach DIN/ISO gefertigt

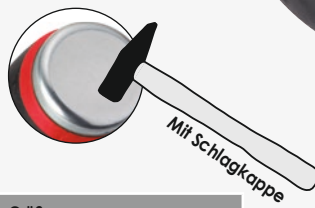

X	Ausführung	Größe mm
4 x		3,5 · 4,5 · 5,5 · 6,5 mm
2 x		PH 1 · PH 2



Schlitz-Schraubendreher mit Schlagkappe



VIGOR No.	SW mm	L mm	EAN 4047728+
V3597	0,6x3,5	75	035972
V3598	0,8x4,5	100	035989
V3599	1x5,5	100	035996
V3600	1,2x6,5	125	036009

Kreuzschlitz-Schraubendreher mit Schlagkappe



VIGOR No.	SW mm	L mm	EAN 4047728+
V3601	PH 1	75	036016
V3602	PH 2	100	036023

V4418, EAN 4047728**044189**
TORX® Schraubendreher-Satz
 • Nach DIN/ISO gefertigt



X	Ausführung	Größe mm
4 x		T 6 · T 7 · T 8 · T 9



V3366, EAN 4047728**033664**
TORX® Schraubendreher-Satz
 • Nach DIN/ISO gefertigt



X	Ausführung	Größe mm
7 x		T 10 · T 15 · T 20 · T 25 · T 27 · T 30 · T 40



TORX® Schraubendreher

VIGOR No.	SW mm	l mm	EAN 4047728+
V4419	T 6	100	044196
V4420	T 7	100	044202
V4421	T 8	100	044219
V4422	T 9	100	044226
V3367	T 10	100	033671
V3368	T 15	100	033688
V3369	T 20	100	033695
V3370	T 25	100	033701
V3391	T 27	100	033916
V3392	T 30	100	033923
V3393	T 40	100	033930



Schraubendreher und Bits



V4199, EAN 4047728**041997**

Sechskant-Steckschlüssel-Schraubendreher-Satz



6

X	Ausführung	Größe mm
6 x		6 · 7 · 8 · 10 · 12 · 13 mm

Sechskant-Steckschlüssel-Schraubendreher

VIGOR No.	SW mm	L1 mm	EAN 4047728+
V4200	6	150	042000
V4221	7	150	042215
V4222	8	150	042222
V4223	10	150	042239
V4224	12	150	042246
V4225	13	150	042253



V4303, EAN 4047728**043038**

Elektronik-Schraubendreher-Satz in Kunststoff-Box

Schnelldreh-Zone

6



NEU



X	Ausführung	Größe mm
4 x		1,6 · 2 · 2,4 · 3 mm
3 x		PH 00 · PH 0

V1208, EAN 4047728012089

Schraubendreher, kurz

• 5,5x38 mm



V1209, EAN 4047728012096

Schraubendreher, kurz

• PH 2x38 mm



V1139, EAN 4047728011396

Winkelschraubendreher-Satz

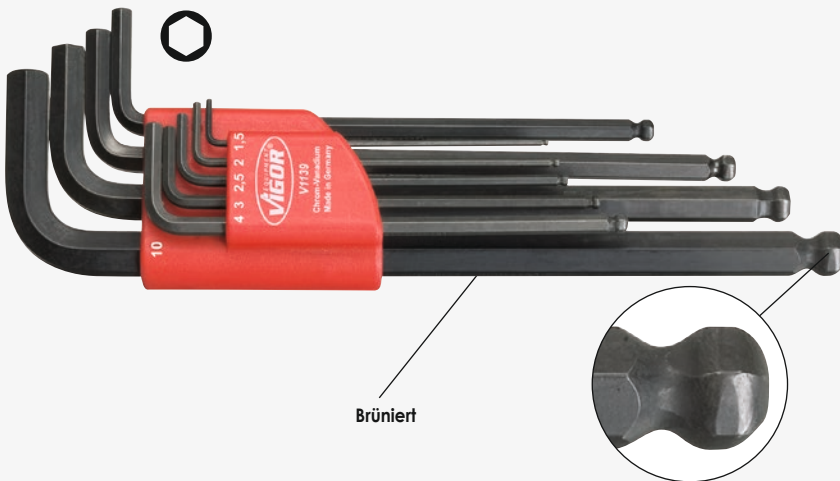

Brüniert



X	Ausführung	SW mm
9 x		1,5 · 2 · 2,5 · 3 · 4 · 5 · 6 · 8 · 10

V1181, EAN 4047728011815

Winkelschraubendreher-Satz

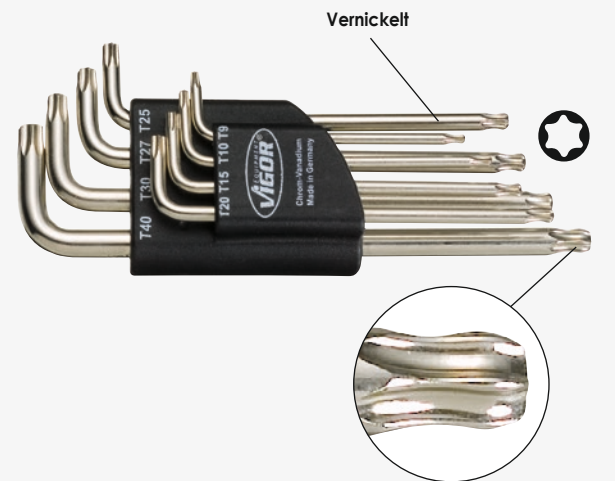

Vernickelt



X	Ausführung	SW mm
8 x		T 9 · T 10 · T 15 · T 20 · T 25 · T 27 · T 30 · T 40

Winkelschraubendreher



VIGOR No.	Bezeichnung	SW mm	l mm	EAN 4047728+
V2448		1,0	40	024488
V2449		1,5	45,5	024495
V2450		2	48	024501
V2451		2,5	51	024518

Schraubendreher und Bits



V1409, EAN 4047728014090

Sechskant-T-Griff Schraubendreher-Satz



2K System



	Ausführung	SW mm
8 x	2 · 2,5 · 3 · 4 · 5 · 6 · 8 · 10	

Sechskant T-Griff Schraubendreher



VIGOR No.	SW mm	L mm	L2 mm	L1 mm	Breite mm	EAN 4047728+
V2489	2	156	160	100	2	024891
V2486	2,5	156	160	100	2,5	024860
V2507	3	156	160	100	3	025072
V2506	4	156	160	100	4	025065
V2505	5	156	160	100	5	025058
V2504	6	216	217	132	6	025041
V2503	8	216	217	132	8	025034
V2502	10	216	217	132	10	025027

V1410, EAN 4047728014106

TORX® T-Griff Schraubendreher-Satz



2K System



	Ausführung	SW mm
8 x	T 9 · T 10 · T 15 · T 20 · T 25 · T 27 · T 30 · T 40	

TORX® T-Griff Schraubendreher

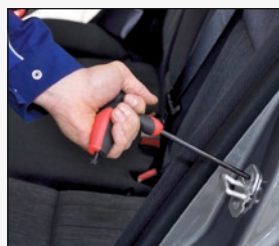

Gültig bis 31.12.2016.

VIGOR No.	SW mm	L mm	L2 mm	L1 mm	Breite mm	EAN 4047728+
V2498	T 9	156	160	100	3	024983
V2497	T 10	156	160	100	3	024976
V2501	T 15	156	160	100	3,5	025010
V2490	T 20	156	160	100	4	024907
V2485	T 25	156	160	100	4,5	024853
V2484	T 27	216	217	132	5	024846
V2483	T 30	216	217	132	5,5	024839
V2482	T 40	216	217	132	7	024822

V3427, EAN 4047728034272

6.3 1/4" Bit-Schraubendreher

6.3 1/4"



V2834, EAN 4047728028349

Bit-Box mit Fingerratsche

6.3 1/4" 6.3 1/4"



25



Einzelteilaufstellung ab Seite 54

X	Ausführung	■	SW mm
5 x		6.3 1/4"	5 · 6 · 8 · 10 · 12 · 13
3 x		6.3 1/4"	4 · 5 · 6
3 x		6.3 1/4"	PH 1 · PH 2 · PH 3
3 x		6.3 1/4"	PZ 1 · PZ 2 · PZ 3
7 x		6.3 1/4"	T 10 · T 15 · T 20 · T 25 · T 27 · T 30 · T 40
1 x		6.3 1/4"	50 mm
1 x		6.3 1/4"	60 mm
1 x		6.3 1/4"	-

V1097, EAN 4047728010979

Bit Box

• ~ DIN / ISO

6.3 1/4" 6.3 1/4"



32



Inkl. Gürtelclip

X	Ausführung	■	SW mm
5 x		6.3 1/4"	PH 1 (2x) · PH 2 (2x) · PH 3
5 x		6.3 1/4"	PZ 1 (2x) · PZ 2 (2x) · PZ 3
4 x		6.3 1/4"	4x0,8 · 5x1 · 6,5x1,2 · 8x1,6 mm
4 x		6.3 1/4"	3 · 4 · 5 · 6 mm
6 x		6.3 1/4"	T 15 · T 20 · T 25 · T 27 · T 30 · T 40
6 x		6.3 1/4"	T 10 H · T 15 H · T 20 H · T 25 H · T 27 H · T 30 H
1 x		6.3 1/4"	-
1 x		6.3 1/4"	-

V1616, EAN 4047728016162
Kombizange

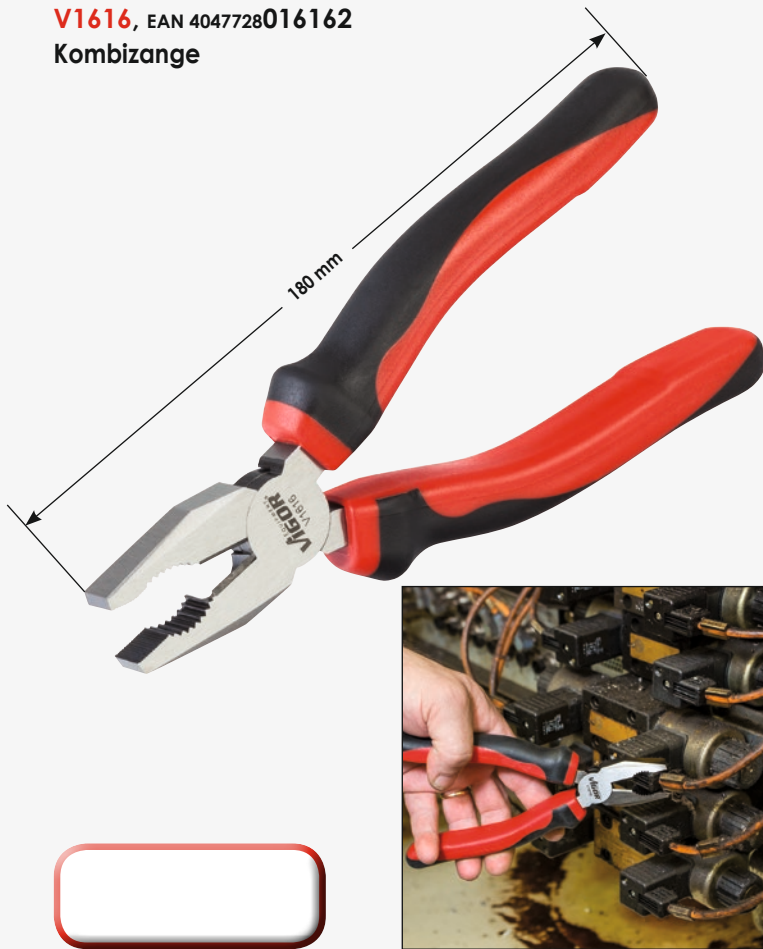

V1617, EAN 4047728016179
Seitenschneider



V2412, EAN 4047728024129
Flachrund-Zange

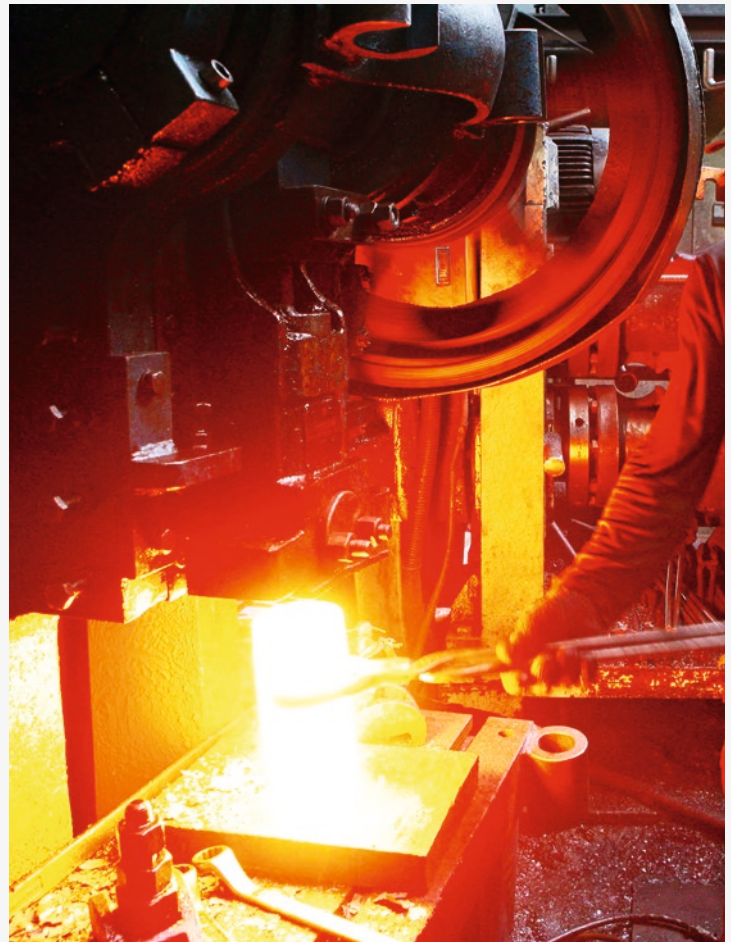

V4441, EAN 4047728**044417**

Zangen-Satz für Sicherungsringe, 140 mm

Inhalt:

- Sicherungsring-Zangen für Bohrungen V4427 (gerade Ausführung) und V4428 (gebogene Ausführung)
- Sicherungsring-Zangen für Wellen V4429 (gerade Ausführung) und V4430 (gebogene Ausführung)



V4442, EAN 4047728**044424**

Zangen-Satz für Sicherungsringe, 180 mm

Inhalt:

- Sicherungsring-Zangen für Bohrungen V1716 (gerade Ausführung) und V1718 (gebogene Ausführung)
- Sicherungsring-Zangen für Wellen V1717 (gerade Ausführung) und V1719 (gebogene Ausführung)

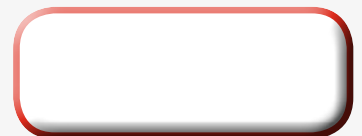

V4427, EAN 4047728**044271**

Sicherungsring-Zange

• Für Bohrungen von 12–25 mm



V4429, EAN 4047728**044295**

Sicherungsring-Zange

• Für Wellen von 10–25 mm

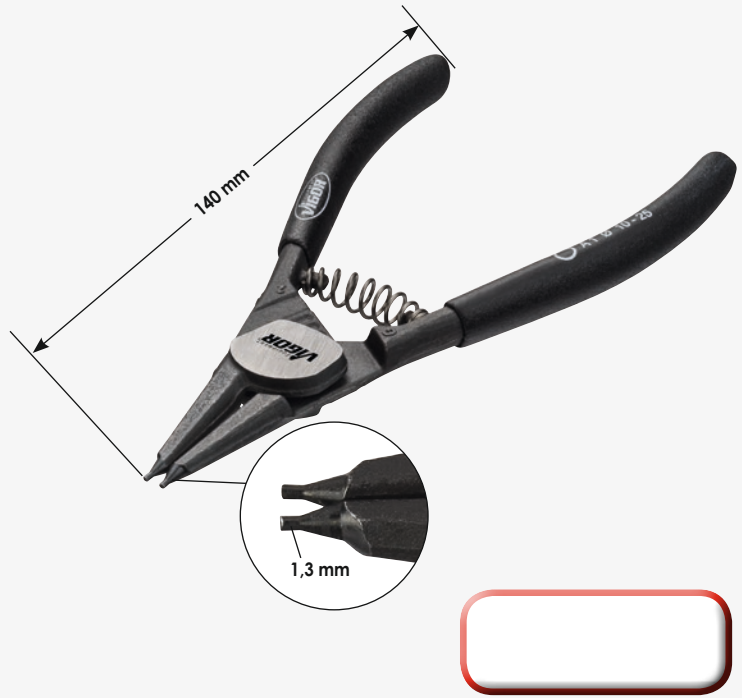

V4428, EAN 4047728**044288**

Sicherungsring-Zange

• Für Bohrungen von 12–25 mm

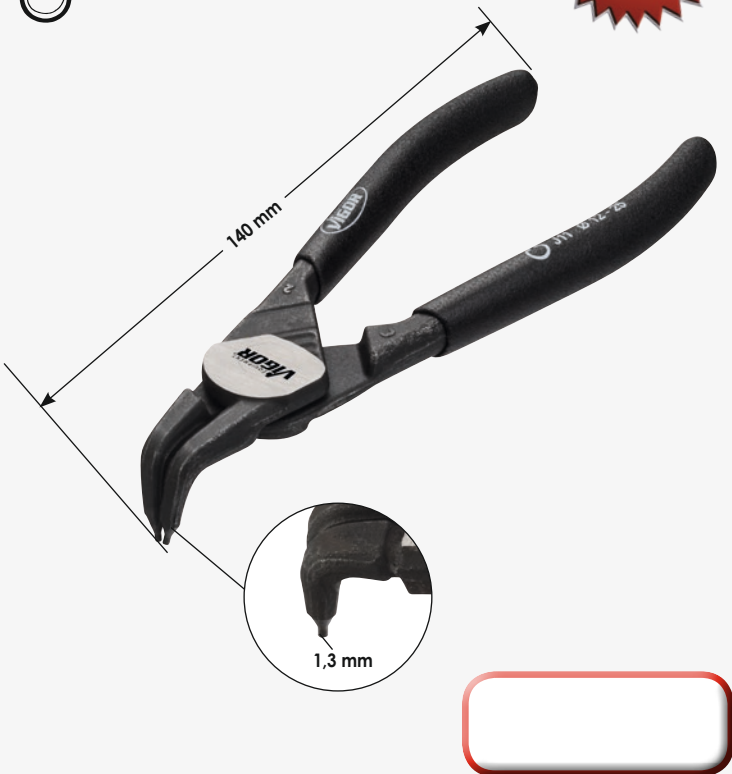

V4430, EAN 4047728**044301**

Sicherungsring-Zange

• Für Wellen von 10–25 mm



Zangen

V1716, EAN 4047728017169

Zange für Sicherungsringe

• Für Bohrungen von 19-60 mm

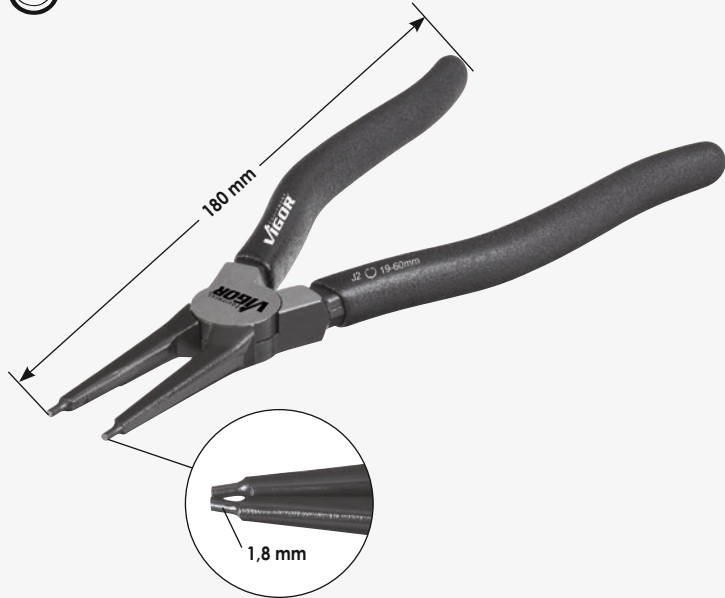

V1717, EAN 4047728017176

Zange für Sicherungsringe

• Für Wellen von 19-60 mm



V1718, EAN 4047728017183

Zange für Sicherungsringe

• Für Bohrungen von 19-60 mm

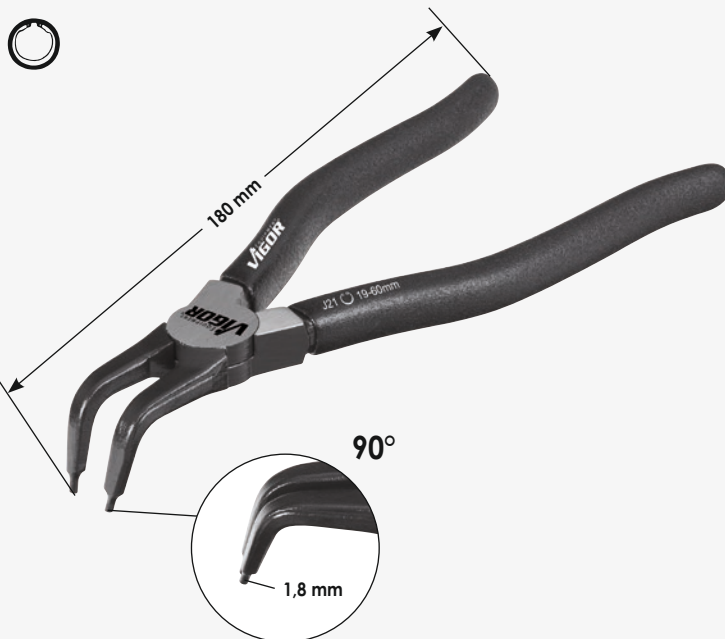

V1719, EAN 4047728017190

Zange für Sicherungsringe

• Für Wellen von 19-60 mm



V2794, EAN 4047728**027946**

Zange für Sicherungsrings

• Für Bohrungen von 40-100 mm

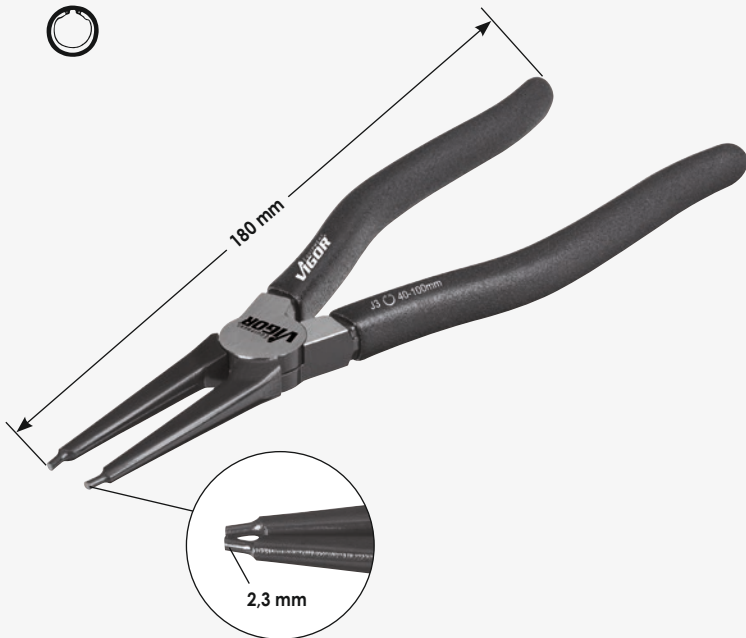

V2792, EAN 4047728**027922**

Zange für Sicherungsrings

• Für Wellen von 40-100 mm

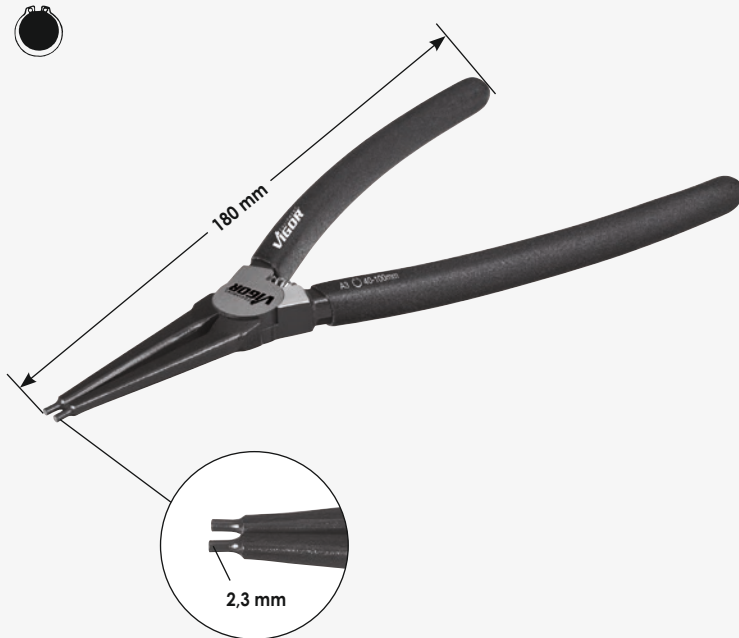

V2793, EAN 4047728**027939**

Zange für Sicherungsrings

• Für Bohrungen von 40-100 mm

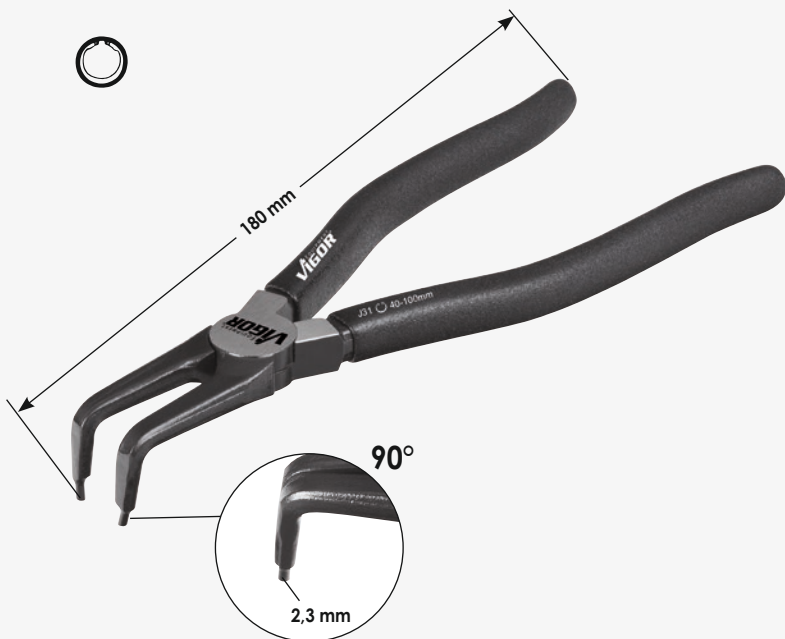

V2791, EAN 4047728**027915**

Zange für Sicherungsrings

• Für Wellen von 40-100 mm

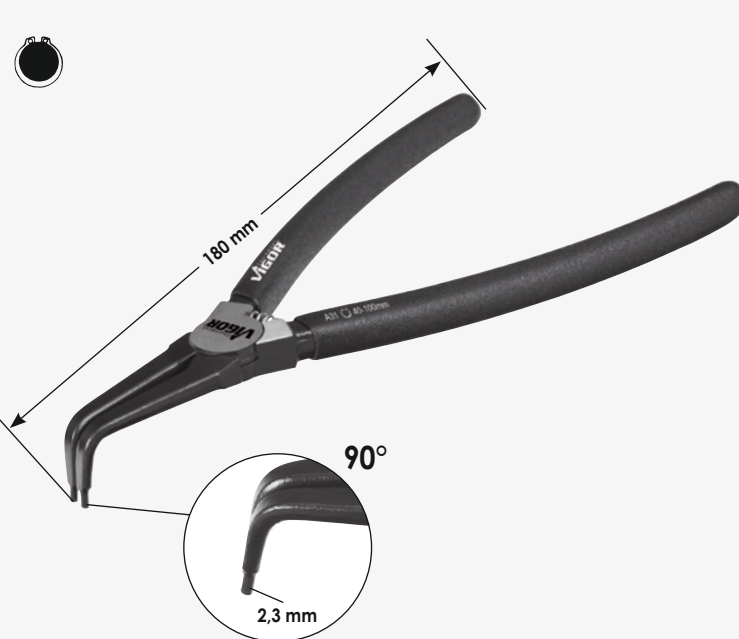

V2781, EAN 4047728027816

Kombizange mit Doppelgelenk

- Gezahnte, extrem schmale Ausführung
- Für schwer zugängliche Bereiche



V2782, EAN 4047728027823

Flachrundzange mit Doppelgelenk

- Gezahnte, extrem schmale Ausführung
- Für schwer zugängliche Bereiche



V2783, EAN 4047728027830

Flachrundzange mit Doppelgelenk

- Gezahnte, extrem schmale Ausführung
- Für schwer zugängliche Bereiche

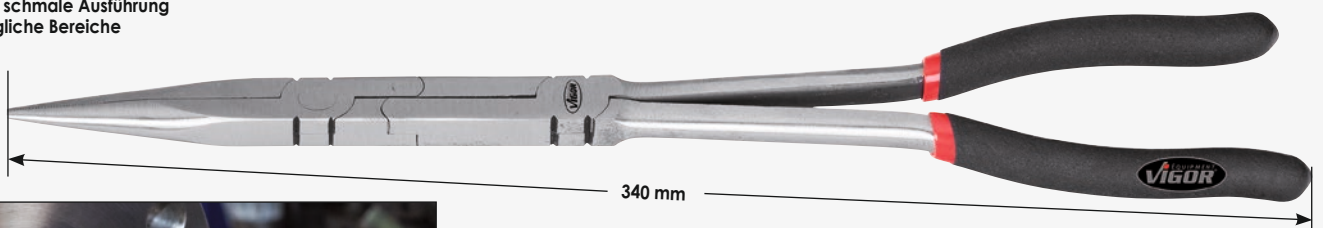

Zangen



V2644, EAN 4047728026444
Einhand-Universalzange



Schnellverstellung



V1426, EAN 4047728014267
Universalzange
• DIN ISO 8976

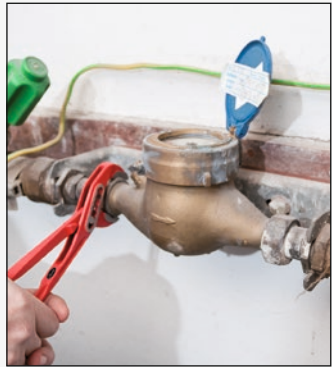

V1785, EAN 4047728017855
Multi-Tool 14-in-1



Inkl.



Zangen

V3738, EAN 4047728037389

Maul-Gripzange



V3739, EAN 4047728037396

Maul-Gripzange



V1808, EAN 4047728018081

Grip-Zangen-Satz in Rolltasche



VIGOR No.	Bezeichnung	mm	EAN 4047728+
V1802		150	018029
V1803		250	018036
V1804		125	018043

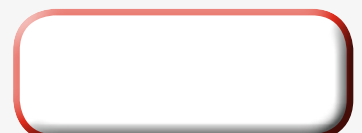

V2499, EAN 4047728024990

Crimpzangen-Satz

- Mit 5 auswechselbaren Crimp-Einsätzen:
- Crimp-Einsatz A: für isolierte Kabelschuhe von 0,5 - 6,0 mm² (rot, blau, gelb)
- Crimp-Einsatz B: für geschlossene, unisolierte Kabelschuhe von 0,5 - 10,0 mm²
- Crimp-Einsatz C: für offene, unisolierte Kabelschuhe von 0,5 - 6,0 mm² (Breite bis 6,3 mm)
- Crimp-Einsatz D: für Aderendhülsen mit und ohne Kragen von 0,5 - 4,0 mm²
- Crimp-Einsatz F: für Aderendhülsen über 4,0 mm²

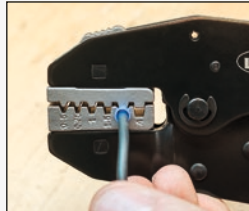

V3735, EAN 4047728037358

Universal-Nietzange für Blindnieten und Nietmutter

- Nietmutter: M5 M6 M8 M10 für Kupfer-, Messing-, Stahl- und Edelstahlnieten
- Blindnieten: 3,2 4,0 4,8 6,4 mm für Kupfer-, Messing-, Stahl- und Edelstahlnieten



Für:
Blindniete



Nietmutter



(nicht im Satz enthalten)



V2788, EAN 4047728027885

Blindniet-Zange

- Für Blindnieten: 3,2 · 4,0 · 4,8 · 6,4 mm
- Für Kupfer-, Messing-, Stahl- und Edelstahlnieten
- Sehr geringer Kraftaufwand bei extrem kurzer Bauform

Für:
Blindniete



(nicht im Satz enthalten)



V4196, EAN 4047728**041966**
Kunststoff-Nietzange

41



Inkl. 40 Kunststoffnieten



10 Stück: 17,2x6,6 mm



10 Stück: 17,2x5 mm



10 Stück: 15,8x5 mm



10 Stück: 25,2x6,3 mm





VDE-Werkzeuge

V3343, EAN 4047728033435

VDE-Steckschlüssel-Satz

• VDE isoliert bis 1000 V nach DIN EN 60900

14



12⁵ 1/2"



1000 V

Einzelteilaufstellung Seite 107

	Ausführung	SW mm / mm
9 x		8 · 10 · 12 · 13 · 14 · 17 · 19 · 22 · 24 mm
3 x		5 · 6 · 8 mm
1 x	12⁵ 1/2"	125 mm
1 x	12⁵ 1/2"	255 mm

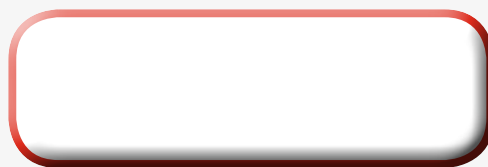



125 1/2 VDE-Umschaltknarre

125 1/2

VIGOR No.	mm	EAN 4047728+
V3342	255	033428



125 1/2 VDE-Steckschlüssel-Einsatz

125 1/2



VIGOR No.	SW mm	L mm	EAN 4047728+
V3330	8	55	033305
V3331	10	55	033312
V3332	12	55	033329
V3333	13	55	033336
V3334	14	55	033343
V3335	17	55	033350
V3336	19	55	033367
V3337	22	55	033374
V3338	24	55	033381



125 1/2 VDE-Schraubendreher-Einsatz

125 1/2



VIGOR No.	SW mm	L mm	EAN 4047728+
V3339	5	78	033398
V3344	6	78	033442
V3340	8	78	033404



125 1/2 125 1/2 VDE-Verlängerung

125 1/2 125 1/2

VIGOR No.	mm	EAN 4047728+
V3341	125	033411

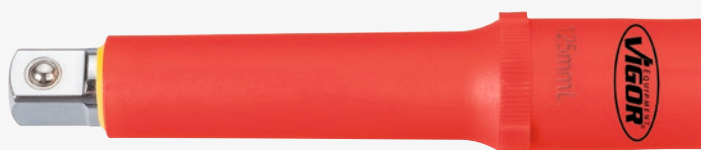

V2027, EAN 4047728**020275**
VDE-Schraubendreher-Satz
 • Nach DIN/ISO gefertigt



X	Ausführung	Größe mm
4 x		3 · 4 · 5,5 · 6,5 mm
3 x		PH 0 · PH 1 · PH 2



VDE-Schlitz-Schraubendreher



VIGOR No.	SW mm	L mm	Breite mm	EAN 4047728+
V2028	0,5x3	100	3	020282
V2029	0,8x4	100	4	020299
V2030	1x5,5	125	5	020305
V2061	1,2x6,5	150	6	020619

VDE-Kreuzschlitz-Schraubendreher



VIGOR No.	SW mm	L mm	EAN 4047728+
V2062	PH 0	60	020626
V2063	PH 1	80	020633
V2064	PH 2	100	020640

V1138, EAN 4047728**011389**

Spannungsprüfer

- 150 bis 250 V, VDE geprüft
- 220 bis 250 V nach VDE 0680
- 3x0,5x140 mm

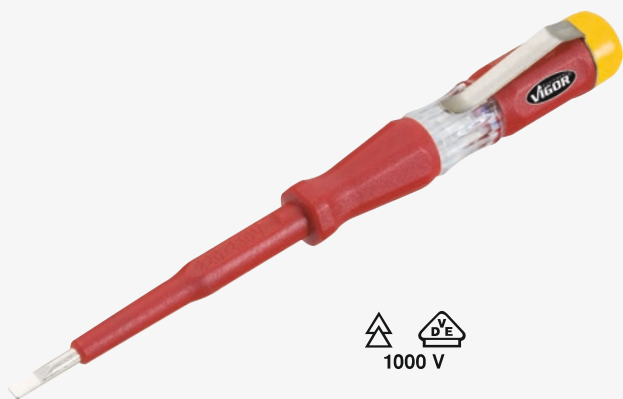

V2641, EAN 4047728**026413**

VDE-Rundzange

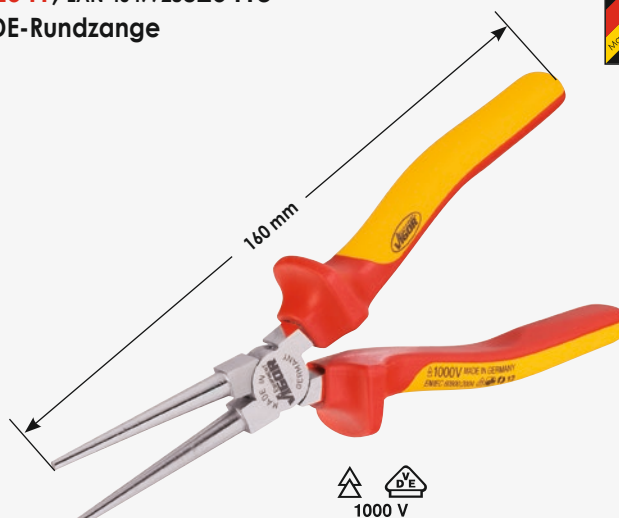

V2628, EAN 4047728026284
VDE-Kombizange



V2629, EAN 4047728026291
VDE-Seitenschneider



V2630, EAN 4047728026307
VDE-Flachrund-Zange



V2643, EAN 4047728026437
VDE-Abisolierzange



Fäustel



VIGOR No.	— L — mm	⚖ g	EAN 4047728+
V4234	260	1000 g	042345
V4235	280	1500 g	042352
V4236	300	2000 g	042369



Schlosser-Hammer



VIGOR No.	— L — mm	⚖ g	EAN 4047728+
V1135	300	300	011358
V2662	320	500	026628
V2665	350	800	026659
V2664	360	1000	026642
V2663	400	2000	026635



V1212, EAN 4047728012126 Kunststoff-Schonhammer



V3541, EAN 4047728035415 Ersatzkopf (Paar)



V4241, EAN 4047728042413 Sub Maker Quadro 10-in-1

- 5 mm
- 6-7 mm
- 8-9 mm
- 5-6 mm
- 6-7 mm
- 8-9 mm
- 2 x 1/4" Bit
- 3-5 mm
- 1/4"





V4227, EAN 4047728**042277**

MasterKey Elektro

- Für fast alle gängigen Schließungen in Sanitär, Elektro, Heizung, Lüftung, Klima etc.

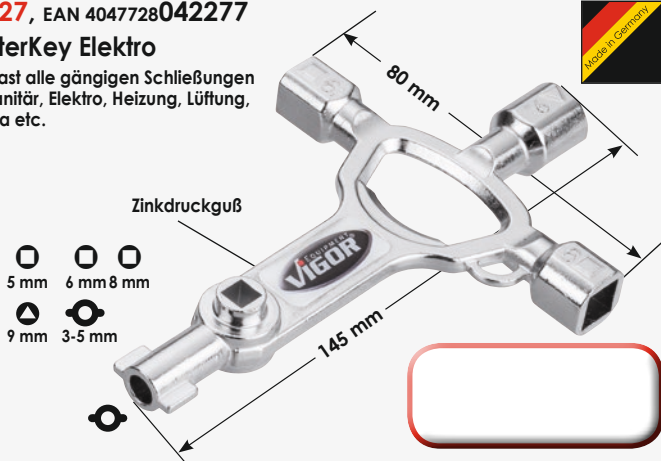

V4228, EAN 4047728**042284**

MasterKey Bau

- Für fast alle gängigen Schließungen in Sanitär, Heizung, Bau, Lüftung, Klima etc.
- Vierkant-Dorn ermöglicht Betätigen der Schloßnuss ohne Türdrücker und Vierkantstift

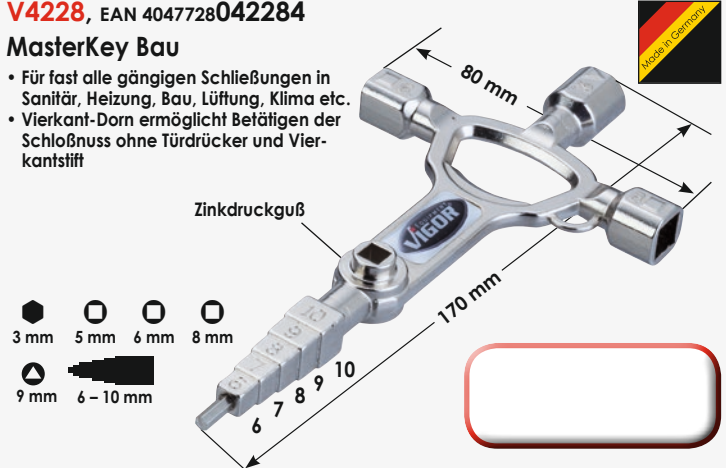

V1221, EAN 4047728**012218**

Flachmeißel



V1222, EAN 4047728**012225**

Kreuzmeißel



V1220, EAN 4047728**012201**

Körner



Splint-Austreiber



VIGOR No.	Bezeichnung	Ø mm	l mm	EAN 4047728+
V1214		2	150	012140
V1215		3	150	012157
V1216		4	150	012164
V1217		5	150	012171
V1218		6	150	012188
V1219		8	150	012195

V1783, EAN 4047728**017831**

Selbstschlagender Körner



V1368, EAN 4047728**013680**

Schaber für Glasoberflächen

- Auswechselbare Klinge
- Zum Entfernen von Plaketten, Aufklebern, Vignetten etc.
- Für z.B. Windschutzscheiben, Ceranfelder etc.



V1372, EAN 4047728**013727**

Ersatzklingen



V1213, EAN 4047728**012133**

Schaber

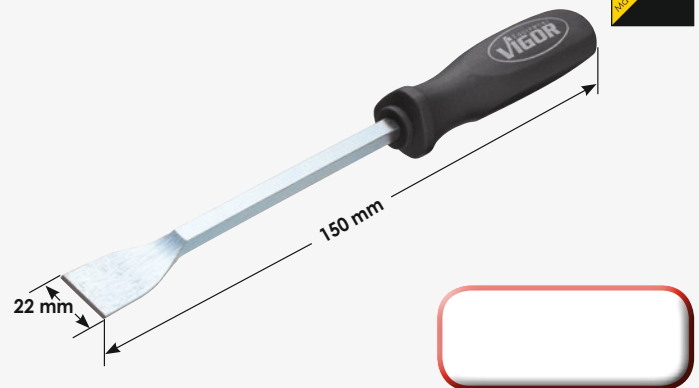

V1283, EAN 4047728012836
Schaber-Satz

VIGOR No.	L2 mm	L1 mm	Breite mm	Dicke mm	EAN 4047728+
V2487	230	105	32	1,2	024877
V2488	230	105	32	2,5	024884
V2509	175	55	20	1,2	025096
V2508	175	55	20	2,5	025089



V1369, EAN 4047728013697
Lösehebel-Satz

VIGOR No.	Bezeichnung	L mm	Breite mm	EAN 4047728+
V2491		160	60	024914
V2492		180	30	024921
V2493		180	20	024938
V2494		200	30	024945
V2495		210	20	024952



V1723, EAN 4047728017237
Haken- und Schaber-Satz



V4310, EAN 4047728**043106**

Lösehebel

- Durch schmale Bauart ideal zum Arbeiten in schwer zugänglichen Bereichen z.B. zur Demontage der Kunststoff-Clips von Tür- und Heckklappen-Verkleidungen



V1301, EAN 4047728**013017**

Hebeleisen-Satz

- Schlagfestes Heft

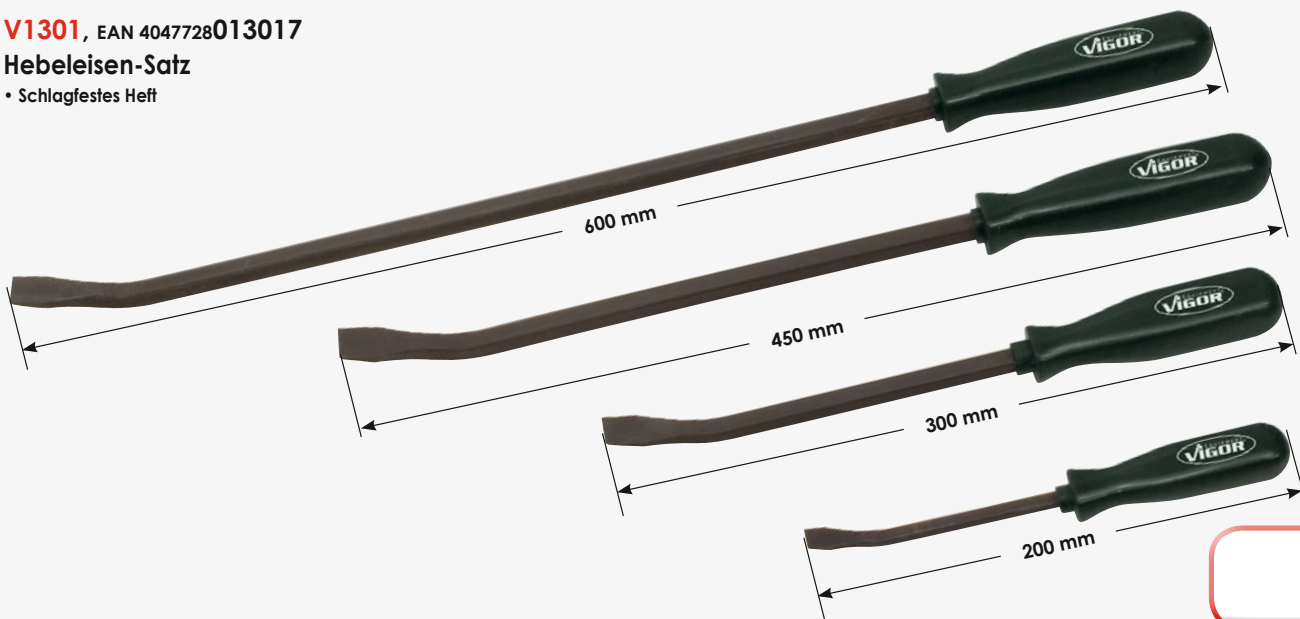

V1429, EAN 4047728**014298**

Brecheisen 70 cm





V1921, EAN 4047728**019217**

6.3 1/4"



Bürsten-Satz

- Zum professionellen Reinigen und Entgraten von Zylindern, Röhren, Buchsen usw.
 - Für Betrieb mit Bohrmaschinen und Druckluftbohrern geeignet
- ACHTUNG:** Bei Maschinenverwendung nur rechtslaufend einsetzen

Inhalt:

- 12 Nylonbürsten:
- Ø 8 9 10 11 12 13 14 15 16 17 18 19 mm
- 12 Stahlbürsten:
- Ø 8 9 10 11 12 13 14 15 16 17 18 19 mm
- 12 Bürsten mit Messingbeschichtung:
- Ø 8 9 10 11 12 13 14 15 16 17 18 19 mm
- 1 Handgriff mit Aufnahme und Schnellverriegelung
- 1 Verlängerung 150 mm



Hinweis:

Bei Maschinenverwendung nur rechtslaufend einsetzen!

Messingbürsten



Stahlbürsten



Nylonbürsten



V1915, EAN 4047728**019156**

360°-Kettenbürste zur Reinigung von Motorrad-/ Fahrrad-/ Antriebsketten

- Kettenbürste zur 360° Reinigung von Antriebsketten der Größen 400, 500 und 600 für ATV (Quads), Motorrad, Fahrrad und Industrie
- Zur Reinigung von Ketten mit O-, X- oder Z-Ringsystem

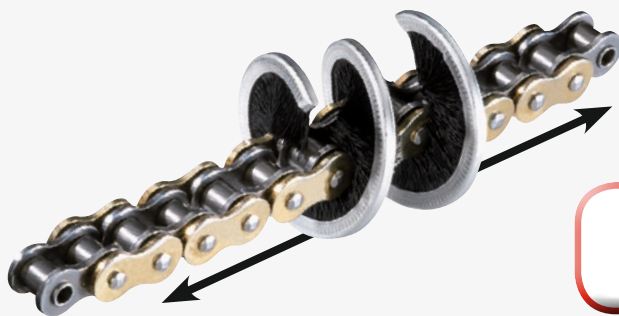

360° Reinigung
~1000 Einzelborsten

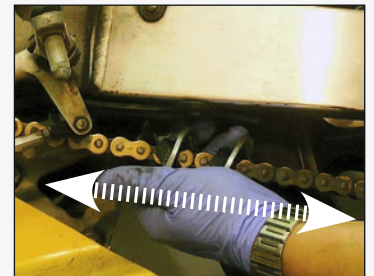
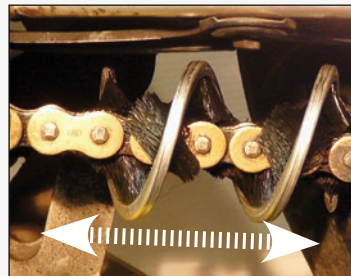
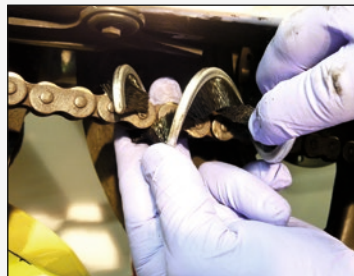
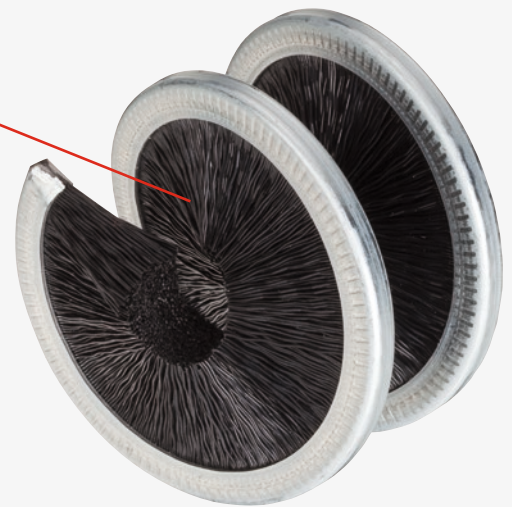
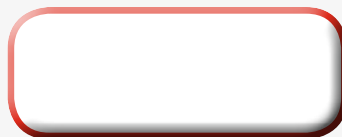

V1438, EAN 4047728014380
Pinzetten-Satz

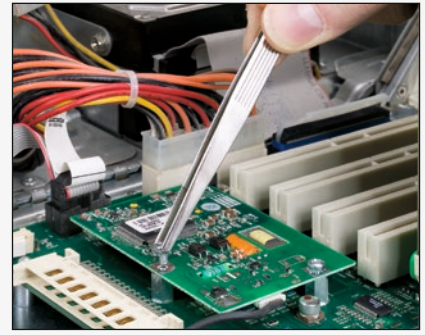

V1741, EAN 4047728017411
Magnetheber



V1764, EAN 4047728017640
Krallengreifer

700 mm



V1893, EAN 4047728018937
Präzisions-Ölspritze



V4277, EAN 4047728042772

Profi Kartuschenpresse

- Zur besseren und leichteren Dosierung von verschiedensten Stoffen wie z.B.: Silikon, Acryl, Klebe- und Dichtstoffen
- Robuste und zugleich leichte Aluminium-Kartuschenpresse
- Geeignet für handelsübliche Kartuschen und Beutel



Befüllmenge: 310 ml



Inkl. 4 Hülsen



Befüllungsmöglichkeiten:



Kartusche



Beutel



V1367, EAN 4047728013673

LötKolben

□ 3x AA 1,5 V



Max. 480° C



V2338, EAN 4047728023382

Kniekissen



V4279, EAN 4047728**042796**

Japanspachtel Metall-Satz

- Zum Auftragen von Material bzw. zum Glätten von Oberflächen sowie zum Einsatz in vielen weiteren Anwendungsbereichen

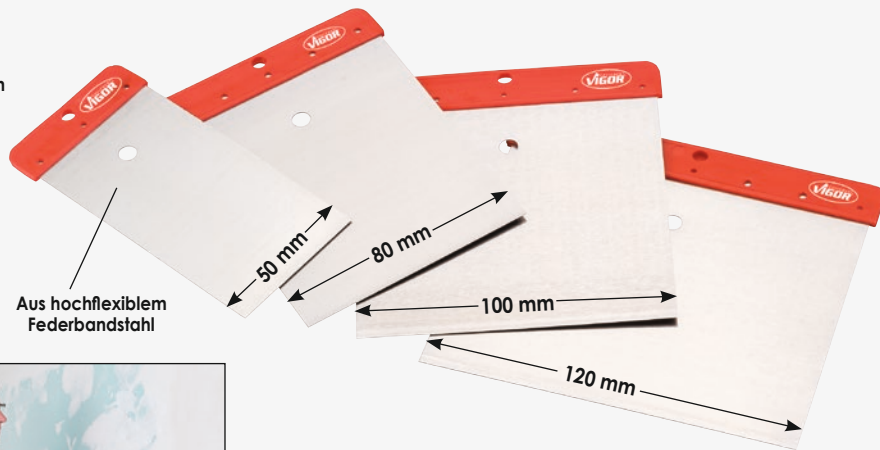

V4278, EAN 4047728**042789**

Japanspachtel Kunststoff-Satz

- Zum Auftragen von Material bzw. zum Glätten von Oberflächen sowie zum Einsatz in vielen weiteren Anwendungsbereichen
- Ideal geeignet für Arbeiten im Karosseriebereich, z.B. Verfüllen von Löchern und Dellen sowie vielen weiteren Anwendungsbereichen



Wasserwaage

- 1,3 mm starker Aluminium-Rahmen
- Geschliffene Oberfläche
- Genauigkeit: 0,5 mm/m

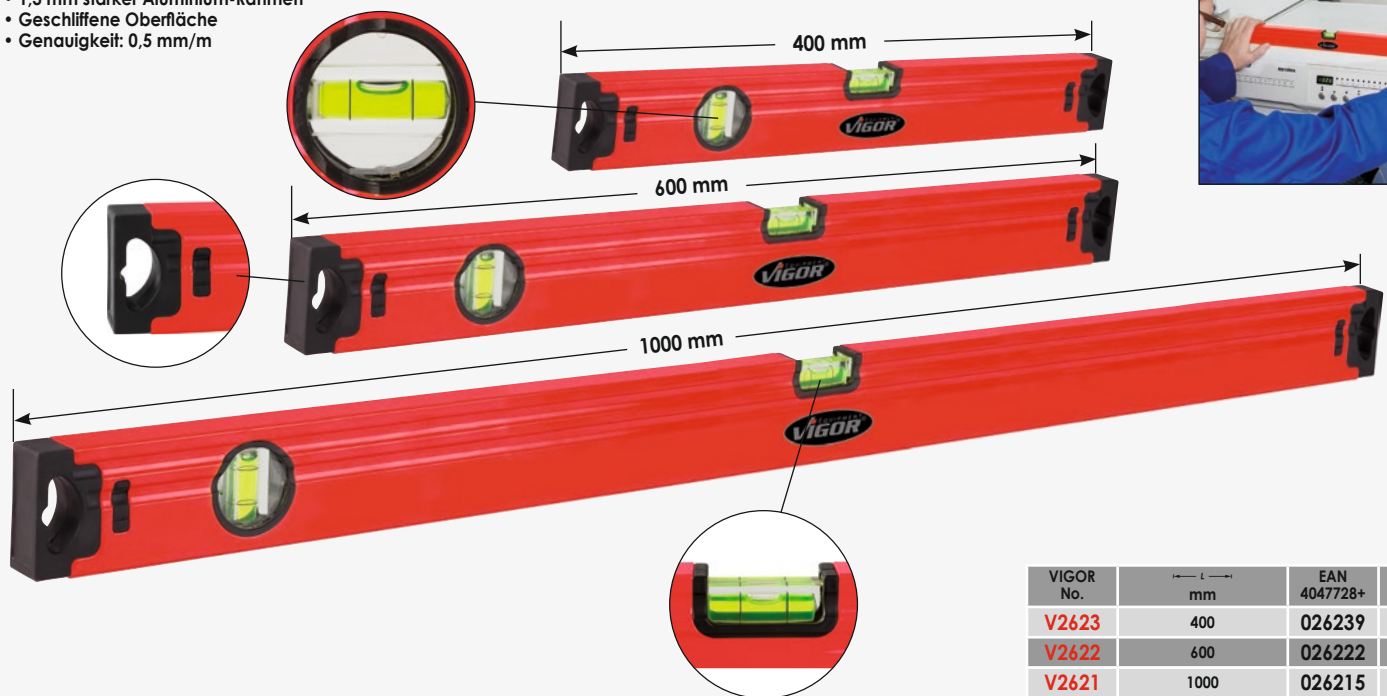

VIGOR No.	l mm	EAN 4047728+
V2623	400	026239
V2622	600	026222
V2621	1000	026215

V1713, EAN 4047728017138

Digitaler Messschieber

□ 1,5 V (LR 44) – 180 mAh



V1724, EAN 4047728017244

Bandmaß



V1714, EAN 4047728017145

Fühlerlehren-Satz



V2790, EAN 4047728027908

Kleine Handbügel-Säge

• Handelsübliche Sägeblätter

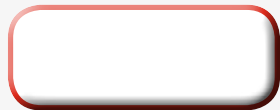
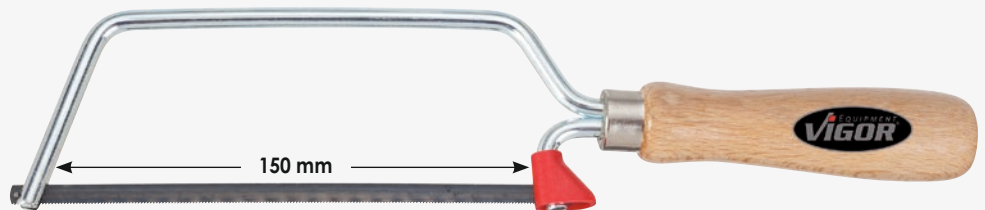

V1715, EAN 4047728017152

Sägebogen

• Handelsübliche Sägeblätter

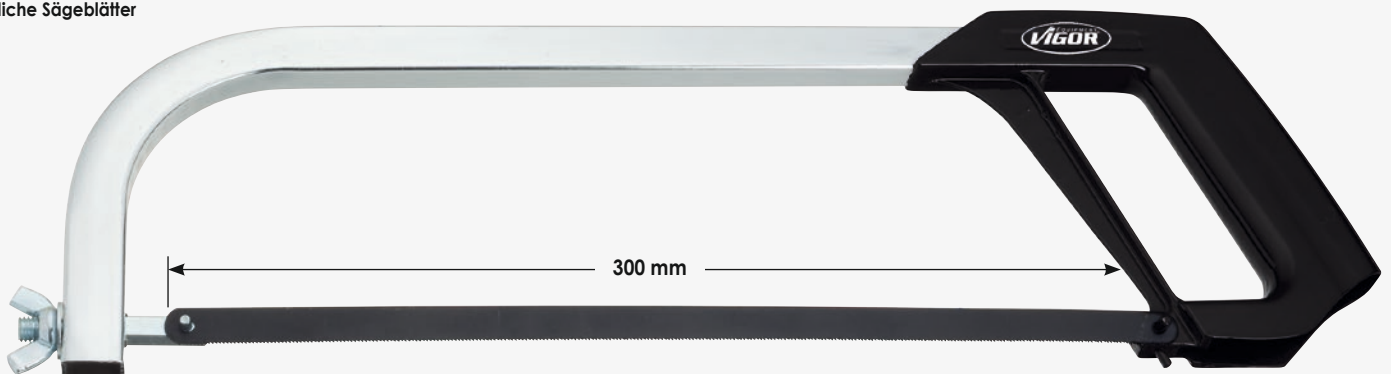

Schneiden/Sägen/Zerspannen



V1809, EAN 4047728018098

Japanische Zugsäge



V1304, EAN 4047728013048

Universal-Schere



V2627, EAN 4047728026277
Cutter-Messer



V4308, EAN 4047728043083
Abbrechklingen, 9 mm

- Jede Abbrechklinge besteht aus 12 Einzelklingen, die sich problemlos nach Verschleiß abtrennen lassen
- Passend für Cutter-Messer V2627

10



V4275, EAN 4047728042758
Profi Universalmesser

- Mit stahlgeführter Klingenfixierung zur Unfallminimierung
- Inkl. 6 Abbrechklingen



7



V4274, EAN 4047728042741
Abbrechklingen, 18 mm

- Jede Abbrechklinge besteht aus 8 Einzelklingen, die sich problemlos nach Verschleiß abtrennen lassen
- Passend für Universalmesser V4275

10



V1345, EAN 4047728013451
Universal-Messer

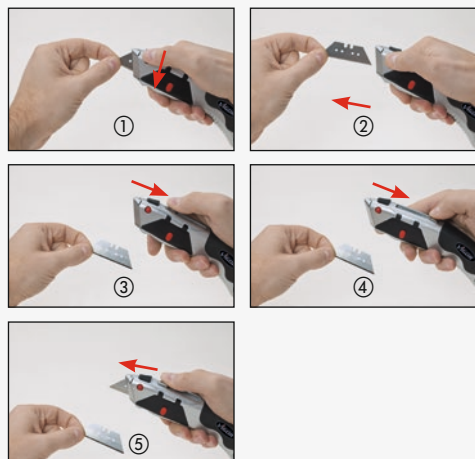

11

V1446, EAN 4047728014465
Ersatzklingen

- Passend für Universalmesser V1345

10



Feilen

- Zahnung (Hieb): 2 = mittel
- DIN 7261

V1787, EAN 4047728017879
Flachstumpf-Feile

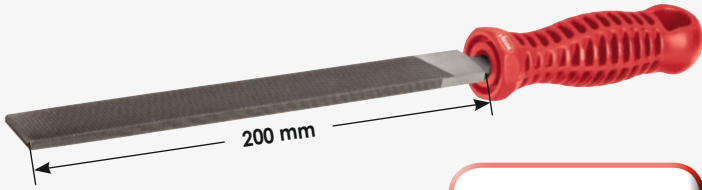

V1788, EAN 4047728017886
Dreikant-Feile

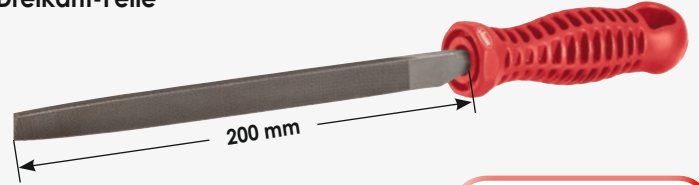

V1789, EAN 4047728017893
Vierkant-Feile

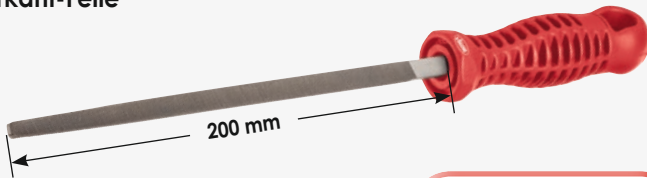

V1790, EAN 4047728017909
Halbrund-Feile

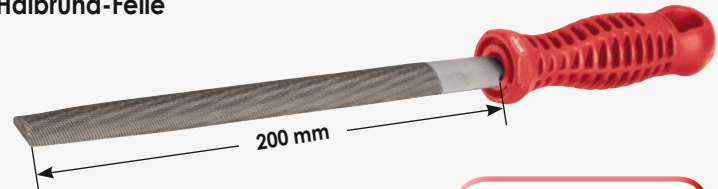

V1801, EAN 4047728018012
Rund-Feile

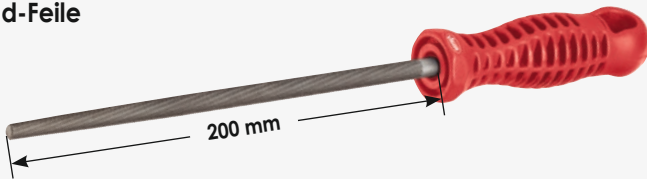

V2651, EAN 4047728026512
Stahl-Drahtbürste



V2654, EAN 4047728026543
Edelstahl-Drahtbürste



V2653, EAN 4047728026536
Drahtbürste mit Schaber



V2652, EAN 4047728026529
Messing-Drahtbürste



V3864, EAN 4047728038645

Gewinde-Reparatur-Satz

- Für Gewinde M6 M8 M10
- Zur Gewinde-Reparatur beschädigter oder abgenutzter Gewinde
- Aufgrund extremer Dünnwandigkeit sowie einseitiger Bauform sind Reparaturhülsen temperaturbeständig und drehen nicht aus

- Inhalt:
- 3 Stück hochlegierte HSSE Spiralbohrer mit 8% Kobalt
- 3 Stück HSSG Präzisions-Gewindebohrer
- 5 Stück Reparaturhülsen M6 x 1,00 x 12 mm
- 5 Stück Reparaturhülsen M8 x 1,25 x 16 mm
- 5 Stück Reparaturhülsen M10 x 1,50 x 20 mm
- 3 Stück Eindreh-Werkzeuge, Größe: M6 M8 M10

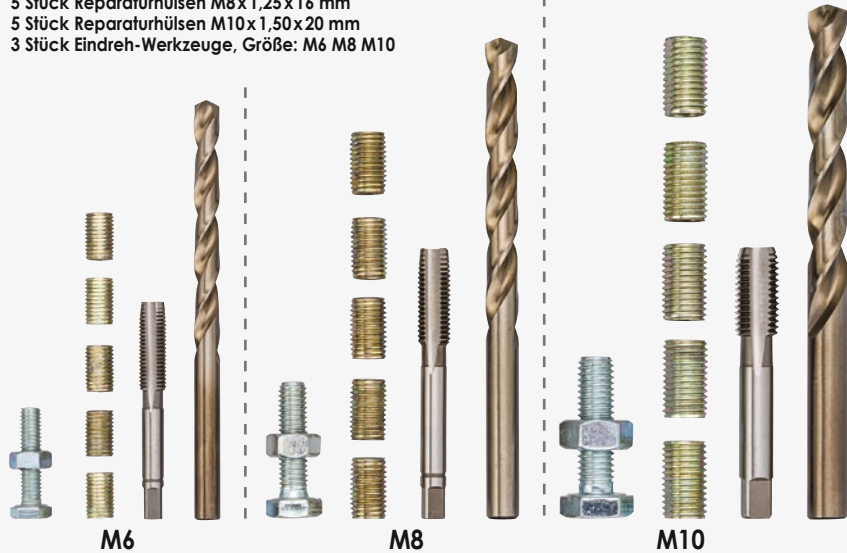

Reparatur-Gewindehülse

VIGOR No.	SW mm		EAN 4047728+
V4213	M6	5	042130
V4214	M8	5	042147
V4215	M10	5	042154

V2253, EAN 4047728022538

Gewindebohrer-Satz

- DIN EN 22568
- HSS Material, geschliffen



Inhalt:

- 7 Handgewindebohrersätze (bestehend aus Vor-, Nach- und Fertigschneider)
- M 3 · M 4 · M 5 · M 6 · M 8 · M 10 · M 12
- 7 runde Schneideisen M 3 · M 4 · M 5 · M 6 · M 8 · M 10 · M 12
- 1 Windeisen
- 1 Schneideisenhalter
- 1 Gewindelehre
- 1 Schraubendreher

V1203, EAN 4047728012034

Spiralbohrer-Satz

- DIN 338 für Metall
- Spiralbohrer 1-10 mm, 0,5 mm steigend



V1707, EAN 4047728017077

HSS Stufenbohrer-Satz



VIGOR No.	l mm	Ø mm	EAN 4047728+
V2394	65	4-12	023948
V2395	75	4-20	023955
V2396	100	4-30	023962

V2626, EAN 4047728026260

Rohrschneider

- Für Rohre aus Kupfer, Messing, Leichtmetall und PVC-Hartkunststoff



V2625, EAN 4047728026253

Rohrschneider

- Für Rohre aus Kupfer, Messing, Leichtmetall und PVC-Hartkunststoff



V2624, EAN 4047728026246

Ratschen-Rohrschneider

- Für Rohre aus VA-Stahl, Kupfer, Messing, Leichtmetall und PVC-Hartkunststoff



V3309, EAN 4047728033091

Auspuff-Ratschenrohrschneider

- Ratschenfunktion erlaubt Arbeiten auch an schwer zugänglichen Stellen
- Schneidet Edelstahl, Stahl, Kupfer, Aluminium
- Arbeitsbereich: 32 - 67 mm
- Schnitttiefe: 3 mm



V3451, EAN 4047728034517

Ersatzklingen

V2316, EAN 4047728023160

LED-Knicklampe

- ☐ Li-Ion Akku 3,6 V ⊕ 3,5 – 4 h
- 5 LED = 300 Lux bei 60 cm
- 18 LED = 800 Lux bei 60 cm
- ⚖ ca. 200 g



Abnehmbar



5 LED = 5h

18 LED = 1,5 h

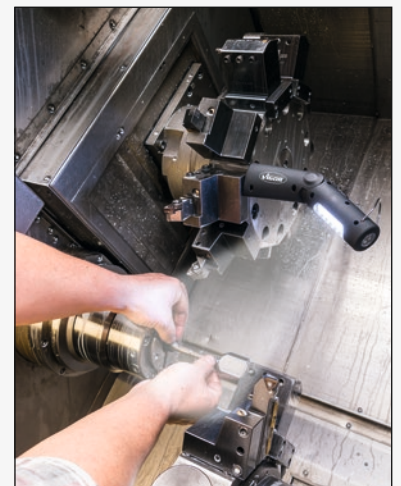

V2347, EAN 4047728023474

12 V Ladegerät für LED-Knicklampe V2316

- Für Zigarettenanzünder





V2669, EAN 4047728026697

Taschenlampe, 1 Watt

- 1 Watt LED
- Leistungsstärke: 90 Lumen
- Inkl. 1 x AA Batterie

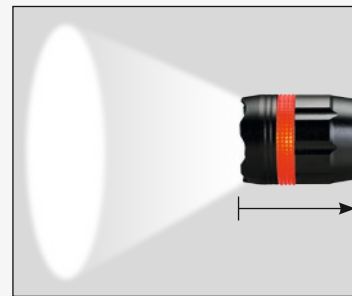
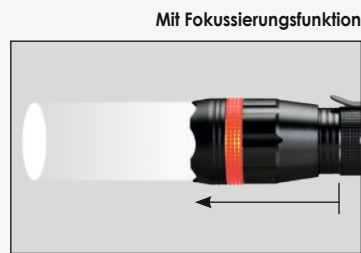
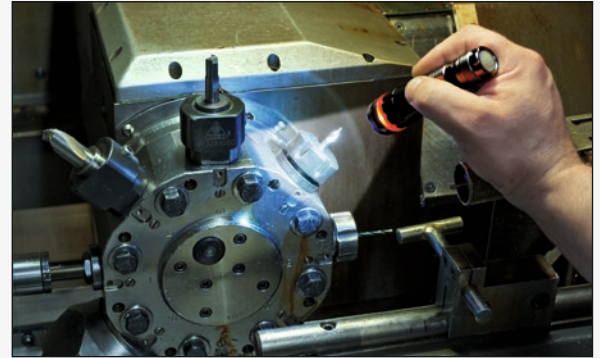

V1911, EAN 4047728019118

Stirnlampe

- Leistungsstärke: 100 Lumen
- Inkl. 3 x AAA (Micro)
- ca. 3 h
- 80 g

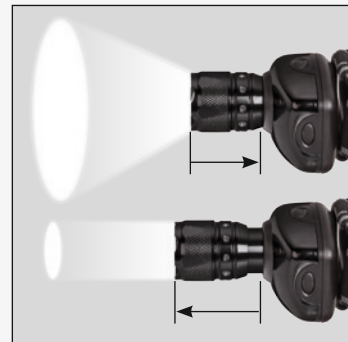

- ☐ = normales Licht
- ☐☐ = helles Licht
- ☐☐☐ = Blinklicht



Verstellbar in 5 Positionen





Drehmoment-Werkzeuge

V4431-2, EAN 4047728**044332**

T-Griff Drehmoment-Schraubendreher

- Drehmoment-Auslösung: Haptisch und akustisch
- DIN EN ISO 6789:2003 (D), Vierkant nach DIN 3120 A, ISO 1174-1A
- Slipper Schlüssel mit Überlastkupplung → somit kein Überziehen möglich
- Nur Rechtsanzug somit kein Lösen von Verschraubungen möglich
- Insbesondere geeignet für Verschraubungen bei Reifendruck-Kontroll-Systemen (RDKS)

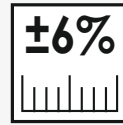

6.3 1/4"

0.2-2 Nm



6.3 1/4"

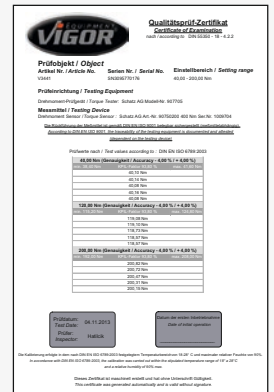

V4431-1, EAN 4047728**044325**

T-Griff Drehmoment-Schraubendreher

- Drehmoment-Auslösung: Haptisch und akustisch
- DIN EN ISO 6789:2003 (D), Vierkant nach DIN 3120 A, ISO 1174-1A
- Slipper Schlüssel mit Überlastkupplung → somit kein Überziehen möglich
- Nur Rechtsanzug somit kein Lösen von Verschraubungen möglich
- Insbesondere geeignet für Verschraubungen bei Reifendruck-Kontroll-Systemen (RDKS)

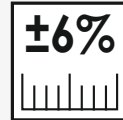

6.3 1/4"

2-10 Nm



6.3 1/4"

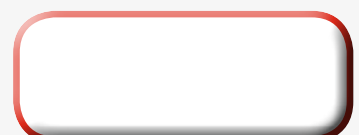
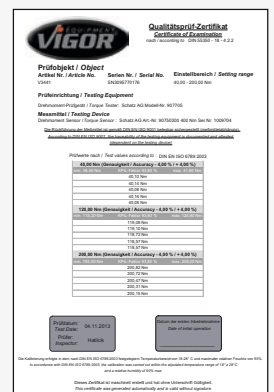



Drehmoment-Werkzeuge

V3441, EAN 4047728034418

Drehmoment-Schlüssel

- Drehmoment-Auslösung: Haptisch und akustisch
- DIN EN ISO 6789:2003 (D), Vierkant nach DIN 3120 A, ISO 1174-1A

Qualitätsprüf-Zertifikat	
Certificate of Examination	
Prüfobjekt / Object	Einheitsbereich / Setting range
V3441	40-200 Nm
Profianrichtung / Testing Equipment Drehmoment-Prüfgerät / Torque Tester: Schmal AG Modell-Nr. 967705 Messmittel / Measuring Device Drehmoment-Sensoren / Torque Sensors: Schmal AG Art-Nr. 9677000-000 Ser-Nr. 1007070 Die Messmittel sind nach DIN EN ISO 6789:2003 (D) geprüfter und zertifizierter Messmittel.	
Prüfwerte nach / Test values according to: DIN EN ISO 6789:2003	
40,00 Nm (Genauigkeit / Accuracy: ±0,05 N·m / ±0,4%)	40,00 Nm
50,00 Nm	50,00 Nm
60,00 Nm	60,00 Nm
70,00 Nm	70,00 Nm
80,00 Nm	80,00 Nm
90,00 Nm	90,00 Nm
100,00 Nm (Genauigkeit / Accuracy: ±0,05 N·m / ±0,5%)	100,00 Nm
120,00 Nm	120,00 Nm
140,00 Nm	140,00 Nm
160,00 Nm	160,00 Nm
180,00 Nm	180,00 Nm
200,00 Nm (Genauigkeit / Accuracy: ±0,05 N·m / ±0,5%)	200,00 Nm
220,00 Nm	220,00 Nm
240,00 Nm	240,00 Nm
260,00 Nm	260,00 Nm
280,00 Nm	280,00 Nm
300,00 Nm	300,00 Nm
320,00 Nm	320,00 Nm

40-200 Nm

12⁵ 1/2"



540 mm



Doppelskala:
Nm und lbf.ft.

Skalenteilung:
1 Nm



Griff mit Aufhängeöse



**Drehmoment-Technik:
„Made in Germany“**



12⁵ 1/2"

Feinverzahnte Umschaltknarre



V3899, EAN 4047728038997

Drehmoment-Schlüssel

- Drehmoment-Auslösung: Haptisch und akustisch
- DIN EN ISO 6789:2003 (D), Vierkant nach DIN 3120 A, ISO 1174-1A

Qualitätsprüf-Zertifikat	
Certificate of Examination	
Prüfobjekt / Object	Einheitsbereich / Setting range
V3899	60-320 Nm
Profianrichtung / Testing Equipment Drehmoment-Prüfgerät / Torque Tester: Schmal AG Modell-Nr. 967705 Messmittel / Measuring Device Drehmoment-Sensoren / Torque Sensors: Schmal AG Art-Nr. 9677000-000 Ser-Nr. 1007070 Die Messmittel sind nach DIN EN ISO 6789:2003 (D) geprüfter und zertifizierter Messmittel.	
Prüfwerte nach / Test values according to: DIN EN ISO 6789:2003	
60,00 Nm (Genauigkeit / Accuracy: ±0,05 N·m / ±0,8%)	60,00 Nm
70,00 Nm	70,00 Nm
80,00 Nm	80,00 Nm
90,00 Nm	90,00 Nm
100,00 Nm	100,00 Nm
120,00 Nm	120,00 Nm
140,00 Nm	140,00 Nm
160,00 Nm	160,00 Nm
180,00 Nm	180,00 Nm
200,00 Nm (Genauigkeit / Accuracy: ±0,05 N·m / ±0,8%)	200,00 Nm
220,00 Nm	220,00 Nm
240,00 Nm	240,00 Nm
260,00 Nm	260,00 Nm
280,00 Nm	280,00 Nm
300,00 Nm	300,00 Nm
320,00 Nm	320,00 Nm

60-320 Nm

12⁵ 1/2"

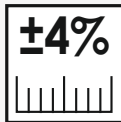

610 mm



Doppelskala:
Nm und lbf.ft.

Skalenteilung:
2 Nm



Griff mit Aufhängeöse



**Drehmoment-Technik:
„Made in Germany“**



12⁵ 1/2"

Feinverzahnte Umschaltknarre



Drehmoment-Werkzeuge



V2795, EAN 4047728027953

Drehwinkel-Messgerät

- Feinauflösung (0,1°)
- Drehwinkelbereich bis 999° (addierend)
- Winkelmessungen gegen und im Uhrzeigersinn
- 99 Speicherplätze
- Anzeige für Batterieladestatus
- LED-Alarmanzeige (blinkend)
- Summeralarm-Anzeige
- Akustischer Warnton
- Automatische Selbstabschaltung



V3653, EAN 4047728036535
Schlagschrauber









12⁵ 1/2"

Hochleistungs-Doppelhammer-Schlagwerk

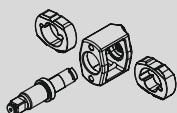
**Max. Lösemoment:
1890 Nm**



Mehrstufiger Rechts-/ Linkslauf mit Einhand-Umschalfunktion

					Kupplungsstecker Nennweite	Luftverbrauch l/min.	 max.	 kg
	6,3 bar	12,92 m/s ²	8500	96 dBA	7,2	113	1890 Nm	1,95



Abluffführung durch Handgriff nach unten

Inklusive Kupplungsstecker

12,91 (1/4)  7,2

V2655, EAN 4047728026550
Ausblas-Pistole



12,91 (1/4) 7,2



V2666, EAN 4047728026666
Ausblas-Pistole, ausziehbar

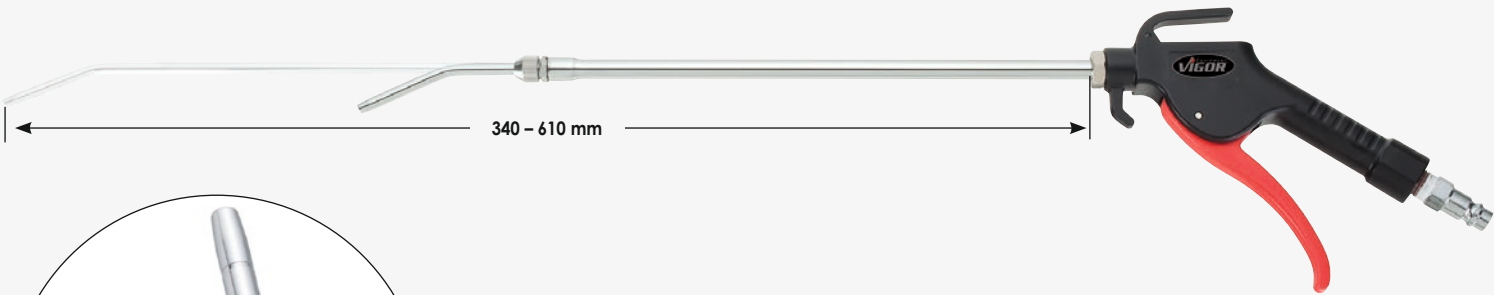

12,91 (1/4) 7,2



V4322, EAN 4047728**043229**

Unterbodenschutz-Pistole

- Für handelsübliche 1000 ml Kartuschen Beiliegender flexibler 500 mm-Schlauch mit Spreizdüse für Rundumwachsnebel ermöglicht problemlosen Wachsaufrag in Hohl- und Zwischenräumen
- Einfaches Auftragen des Unterbodenschutzes (bzw. Schallschutz) mit standardmäßig installierter Düse
- Anwendungstipp: Kartusche öffnen, Ansaugrohr eintauchen, Kartusche festschrauben. Fertig!
- Luftanschluss-Gewinde: 12,91 mm (1/4")
- Kupplungsstecker: integriert, Nennweite 7,2
- Betriebsdruck (bar): 6,3

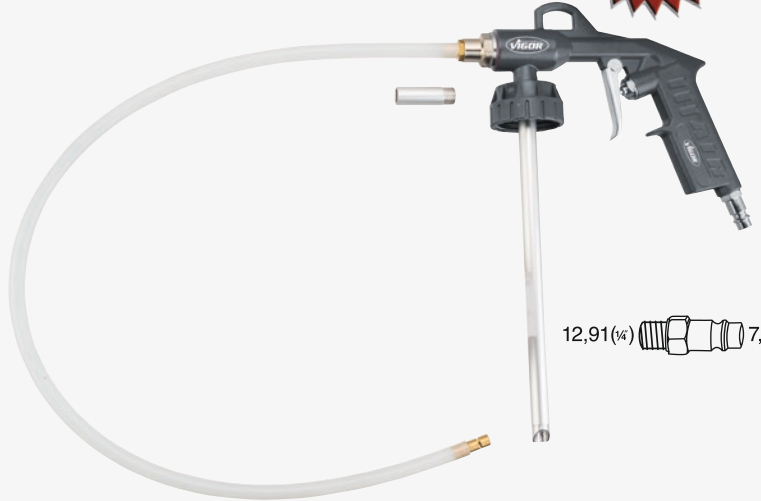

12,91 (1/4")  7,2



V4280, EAN 4047728**042802**









Radio Demontage-Satz

- Zum Aus- und Einbau von Radios und Radio-Navigationsgeräten vieler Fahrzeug- und Gerätehersteller



18



- | | | |
|--|---|-------------------------------------|
|  |  | |
|  | | Becker
(PORSCHE / MERCEDES-BENZ) |
| VW / AUDI | | |
|  |  | ŠKODA |
| Becker | | |
|  |  | Blaupunkt |
| VW | | |
|  |  | AUDI / FORD / VW |
| BMW | | |

In Kunststofftasche



V2682, EAN 4047728026826

Tragehilfe

- Zum Tragen von unhandlichen Gegenständen



Max. Traglast: 120 kg



V1435, EAN 4047728014359

Batterie-Tragegriff

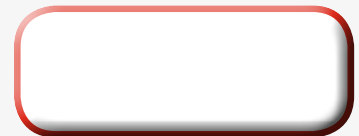
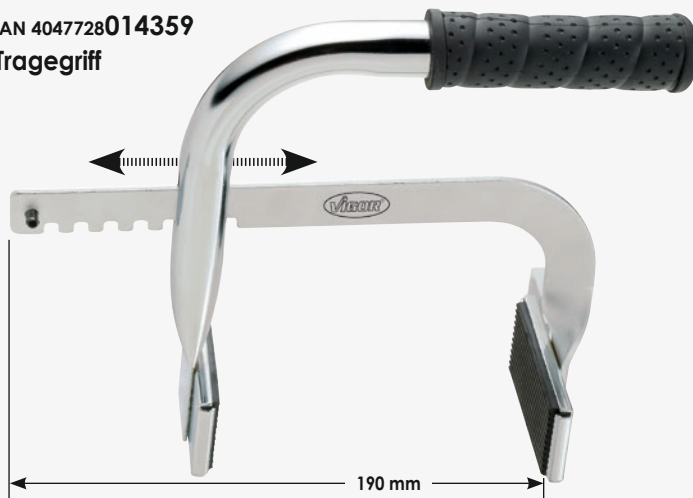

V1757, EAN 4047728017572

Batterietester

- Zur Prüfung der Batteriespannung der Lichtmaschine und des Anlassers

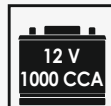
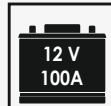
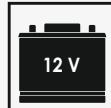

V3748, EAN 4047728037488

Batterietester und Ladesystem-Prüfgerät mit Thermodrucker

- Prüfung der Batterie im eingebauten Zustand
- Inkl. Anlasser- und Ladesystemtest
- LCD-Anzeige: Spannung, Batteriezustand sowie verfügbare Batteriekapazität unter Temperaturkompensation
- Arbeitsbereiche:
 40–2000 A SAE
 40–2000 A EN2
 50–2500 A EN1
 25–1300 A DIN
 30–1500 A IEC



Geeignet zum Testen von Start/Stop-Batterien



TESTBERICHT
=BATTERIE TEST=
URLA/GEL
SOC: 11.91V
GEWAHLT: 368EN
GEMESSEN: 98EN
DEFEKT/ERSETZEN
BATT.-ZUSTAND
■■■■■■■■■■ 27%
LADEZUSTAND
■■■■■■■■■■ 12%
KUNDE:
TEST DATUM:
DURCH:



V1923, EAN 4047728019231
Ersatz-Thermorollen-Paar



V1722, EAN 4047728017220

Autolichtprüfer

6 - 24 V

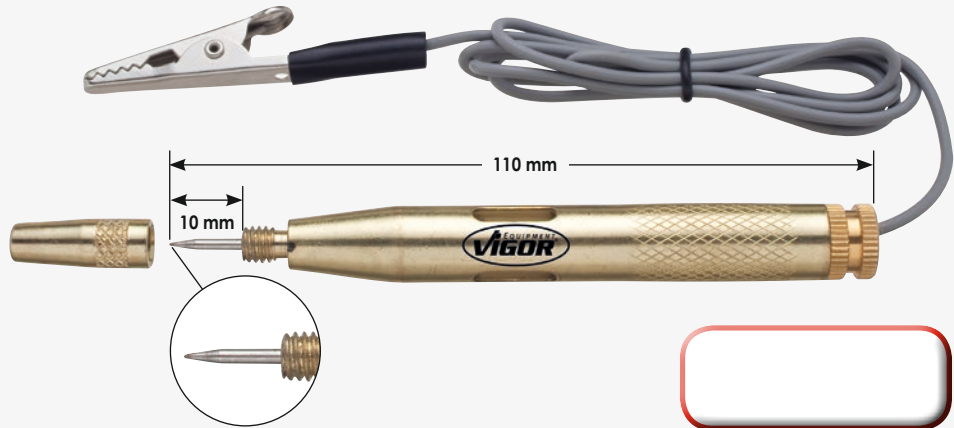

V4324, EAN 4047728**043243**

Digital Multimeter

• Kompakt und handlich

- Kontrastreiche, einzeilige LCD-Anzeige inklusive Hintergrundbeleuchtung
- 19-stelliger Drehschalter
- Zuverlässige Warnung durch automatische Überlauf- und Polaritätsanzeige zur möglichen Fehlervermeidung
- Aufstellbar inklusive Gummi-Schutzhülle
- Messkabel mit Berührungsschutz
- DC: 200 mV – 600 V
- AC: 200 V – 600 V
- DC: 200 mA – 10 A
- Widerstand: 200 – 2000 Ohm
- Dioden-Tester
- Max. Anzeige: 1999
- 9V Batterie (im Gerät)
- Sicherungen: 1x 200 mA / 250V
1x 10A / 250V
- Multimeter zur Ruhestromprüfung
- Anwendbar mit Messkabel-Satz V4326
- Funktionen:
Gleich- und Wechselspannungs-Messungen
Gleich- und Wechselstrom-Messung
Widerstandsmessung
Diodenprüfung (mit akustischem Signal)
Durchgangsprüfung (mit akustischem Signal)
Data Hold Funktion



V4326, EAN 4047728043267

Messkabel-Satz

- Geeignet für Kfz-Bedarf und 12 V Batterien
- Satz mit verschiedenen Messleitungsadaptern zur Vereinfachung der Fehlersuche direkt am Fahrzeug
- Mit umfangreichen Verbindungselementen, u.a. mit Polaritätsprüfer, mit denen Hallgeber und Photosensoren prüfbar sind sowie Messpotentiometer zur Überprüfung des Temperaturfühlers und Tankgebers
- Zur Verwendung mit handelsüblichen Multimetern

- Infos zum Inhalt:
Je 3 Stück Flachstecker, Flachsteckhülsen, Rundstecker, Stifkabelstecker und Stifkabelhülsen



Größen Flachstecker: 0.8 / 1.2 / 2.0 / 2.5 / 3.0 / 5.0 / 6.0 mm



Größen Rundstecker: 4.0 / 3.5 / 2.0 / 1.5 / 0.8 mm



4x Prüfnadeln u.a. zum Testen sehr kleiner Steckverbindungen



2x Prüfspitzen zur Verwendung mit zu prüfendem Kabel und Krokodilklemmen



2x Zweifarbiges LED Prüfkabel zur Bestimmung der Polarität
– Positive Polarität = LED grün
– Negative Polarität = LED rot



2x 5K-Ohm Potentiometer stufenlos verstellbar



2x Anschlusskabel mit je 1 m Länge



2x Krokodilklemmen Maulöffnung bis 30 mm



2x Brückenstecker 1 (Female-Buchse) auf 2 (Male) Verbindungen



2x SRS Prüf Widerstands-Stecker für SRS Airbag und Gurtschraffsysteme

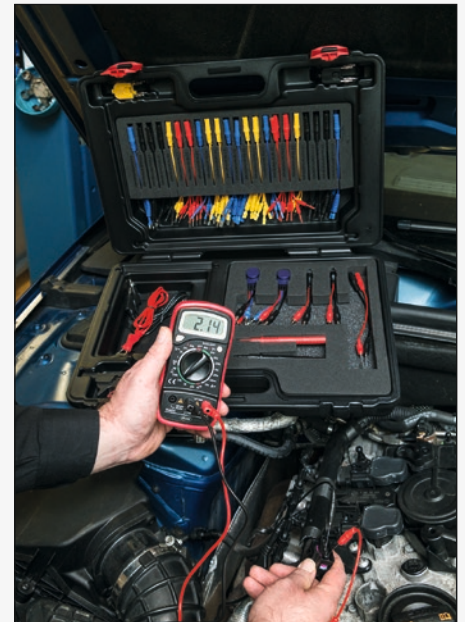

V4451, EAN 4047728**044516**

Kabelentriegelungs-Werkzeugsatz

- Für nahezu alle Fahrzeuge zum beschädigungsfreien Entriegeln elektrischer Stecker und Verbinder z.B. bei ABS, Klimasensoren, Radio, PDC, Anhängerkupplungsmodul u.v.m.
- Zur schnellen Fehlersuche durch Korrosions- oder Verbindungsdefekte
- Passend für Rund- und Flachsteckkontakte
- Unentbehrlich für Mechatroniker und KFZ-Elektriker

23

NEU



<p>①</p> <p>Verwendung: BMW, MERCEDES, OPEL, VW/AUDI</p>	<p>②</p> <p>Verwendung: BMW, JAGUAR, MERCEDES, PORSCHE, SAAB, SEAT, SKODA</p>	<p>③</p> <p>Verwendung: BMW, MERCEDES, OPEL, PORSCHE, VW/AUDI</p>	<p>④</p> <p>Verwendung: FORD</p>	<p>⑤</p> <p>Verwendung: BMW, FORD, MERCEDES, OPEL, PORSCHE, SEAT, SKODA, VW/ AUDI</p>	<p>⑥</p> <p>Verwendung: BMW, FORD, JAGUAR, OPEL, MERCEDES, PORSCHE, SAAB, SEAT, SKODA, VW/AUDI</p>	<p>⑦</p> <p>Verwendung: MERCEDES</p>	<p>⑧</p> <p>Verwendung: FORD, JAGUAR, MERCEDES, OPEL, PORSCHE, VW/ AUDI</p>	<p>⑨</p> <p>Verwendung: FORD, MERCEDES</p>
<p>⑩</p> <p>Verwendung: MERCEDES</p>	<p>⑪</p> <p>Verwendung: BMW, FORD, JAGUAR, MERCEDES, OPEL, PORSCHE, SAAB, SEAT, SKODA, VW/AUDI</p>	<p>⑫</p> <p>Verwendung: OPEL, RENAULT, SKODA, VW/ AUDI</p>	<p>⑬</p> <p>Verwendung: FORD, MERCEDES</p>	<p>⑭</p> <p>Verwendung: FORD, JAGUAR, PORSCHE</p>	<p>⑮</p> <p>Verwendung: BMW, FORD, MERCEDES, OPEL, SEAT, SKODA, VW/AUDI</p>	<p>⑯</p> <p>Verwendung: BMW, FORD, JAGUAR, MERCEDES, OPEL, PORSCHE, VW/ AUDI</p>	<p>⑰</p> <p>Verwendung: BMW</p>	<p>⑱</p> <p>Verwendung: MERCEDES</p>
<p>⑲</p> <p>Verwendung: CITROEN, FIAT, CHRYSLER, FORD, HONDA, MAZDA, OPEL, MERCEDES, MITSUBISHI, POR- SCHE, RENAULT, SEAT, TOYOTA, VW/AUDI</p>	<p>⑳</p> <p>Verwendung: FORD</p>	<p>㉑</p> <p>Verwendung: BMW, FORD, JAGUAR, MERCEDES, OPEL, PORSCHE, SAAB, SEAT, SKODA, VW/AUDI</p>	<p>㉒</p> <p>Verwendung: HONDA, OPEL, TOYOTA, VW/ AUDI</p>	<p>㉓</p> <p>Verwendung: OPEL, VW/AUDI</p>				



Motor/Kühlung/Klima

V3381, EAN 4047728033817

Schlauchklemmen-Satz

• Für Schläuche mit Durchmesser bis 45 mm



V2510, EAN 4047728025102

Rohrleitungsstopper-Satz

• Abklemmzangen und Stopfen zum Verschließen von Rohrleitungen für Kraftstoffsystem, Bremse, Klimaanlage und Servolenkung

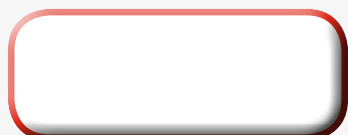

V4341, EAN 4047728043410

Arretierwerkzeug für Nockenwellen-Antriebsräder

- Zur Verwendung an Ein-, Doppel- und Viernockenmotoren
- Ventileinstellung bei Motoren mit oben liegender Nockenwelle wird während Arbeiten am Nockenwellen-Antriebsriemen beibehalten
- Einzel-Arretiervorrichtungen eignen sich perfekt für Wechsel des Riemens der Diesel-Einspritzpumpe
- Inhalt
 - 1 Doppelnockenwellen-Arretiervorrichtung
 - 4 Einzel-Arretiervorrichtungen

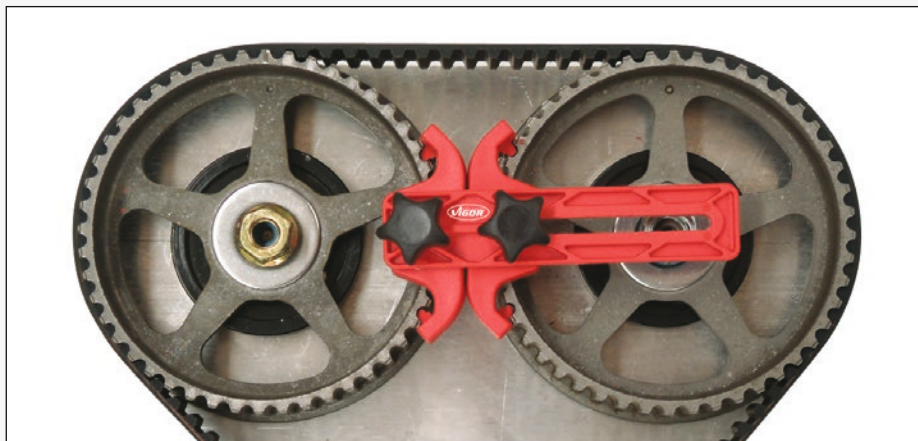
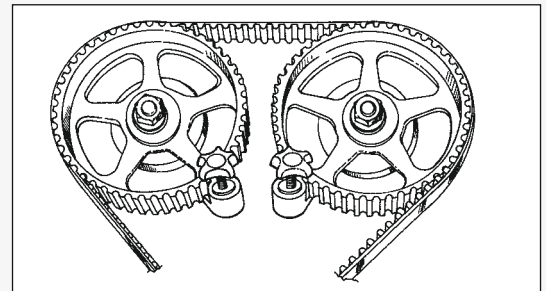
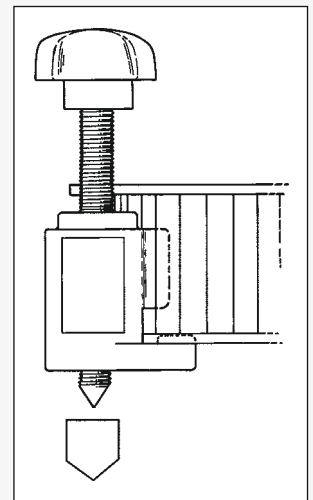

V3771, EAN 4047728037716

Nockenwellen-Arretierwerkzeug

- Zur sicheren Fixierung des Nockenwellenrades
- Ermöglicht das Drehen der Nockenwellen-Antriebsräder ohne Demontage
- Aus extrem starkem glasfaserverstärktem Polymer
- Sehr dünnes Werkzeug für optimalen Zugang bei engen Platzverhältnissen

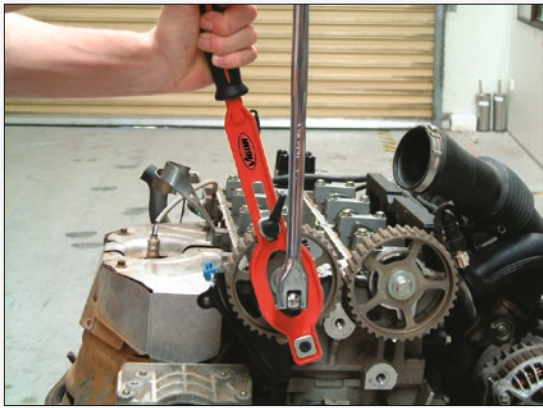

V3571, EAN 4047728035712

Keilrippenriemen Werkzeug-Sortiment

- Aus glasverstärktem Nylon
- Mit einfachster Handhabung auf dem Markt
- Keine Anpassung notwendig
- Passend für alle elastischen Riemenarten: Klimaanlage, Lichtmaschinen sowie einfache und doppelte Riemenscheiben



Montage



Demontage



Montage



Demontage



V4285, EAN 4047728**042857**

Motoreinstell Werkzeug-Satz RENAULT

• Für Arbeiten an Diesel- und Benzinmotoren mit unterschiedlichen Hubräumen

Zum Durchführen folgender Arbeiten:

- Arretierung des Schwungrades
- Arretierung der Kurbelwelle, Nockenwelle und Einspritzpumpenwelle
- Abziehen der Kurbelwellen-Riemenscheibe
- Spannen des Zahnriemens
- Positionierung der Nocken- und Pumpenwelle zur Kurbelwelle

• Geeignet für folgende RENAULT-Motorisierungen:

Benzin: 1.2 / 1.4 / 1.7 / 1.4 / 3.6 / 1.8 / 2.0 16 V / 2.2 8 / 2.5 20V

Diesel: 1.9 D/TD, 2.1 / 2.2 D/TD, 2.5/TD, 2.8 D

• Auch geeignet für Benzin- und Dieselmotoren der Fahrzeugmodelle Volvo V40, S40 sowie OPEL Arena, Movano

• Beispiele für Motorcodes:

B16, B18, B20, N7Q, N7U, K4J, K4M, F4P, F4R, D7F, E5F, E7F, E7J, K7M, F1N, F3N, F3P, F2R, F3R, F7P, F7R, J5R, J7R, J5T, F8M, F8Q, G8T, J8s, F9Q, S8U, S9U, S9W

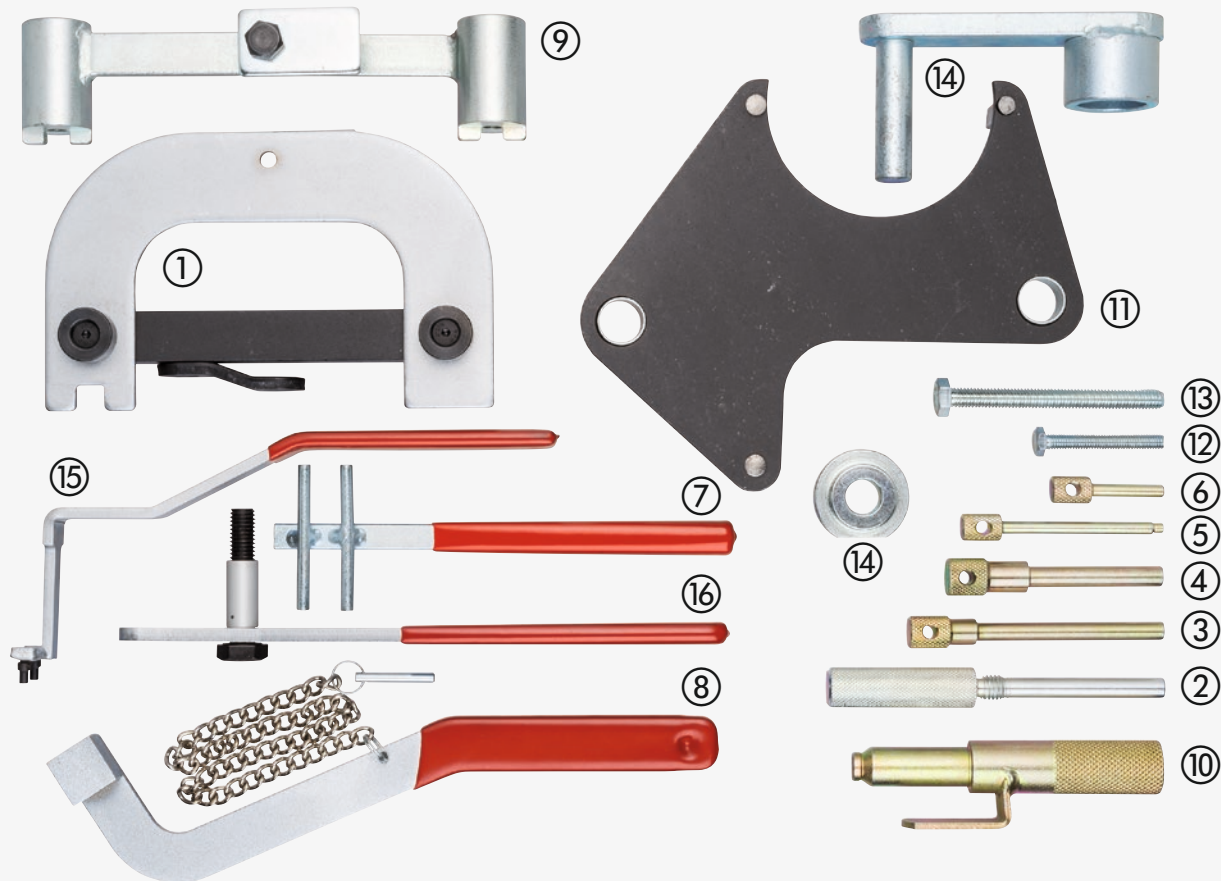

! Nicht verwendbar als Gegenhalter beim Anziehen der Nockenwellen- und Kurbelwellenarretierungen

NR.	Bezeichnung	OEM-Nr.
1	Nockenwellen-Werkzeug	MOT1496
2	Kurbelwellen-Fixierdorn	MOT1489
3	Schwungrad-Fixierdorn	MOT1318
4	Schwungrad-Fixierdorn	MOT861/MOT1054
5	Einspritzpumpen-Fixierdorn	MOT910
6	Kurbelwellen-Fixierdorn	MOT910
7	Viekantantrieb Riemenspanner	MOT1135-01
8	Spannwerkzeug	MOT1348

NR.	Bezeichnung	OEM-Nr.
9	Nockenwellen-Werkzeug	MOT1337
10	Kurbelwellen-Fixierdorn	MOT1340
11	Nockenwellen-Zahn-Ausrichtungs-Werkzeug	MOT1490-01
12	Fixierschraube M6 x30 mm	-
13	Fixierschraube M8 x70 mm	-
14	Spannwerkzeug	MOT1386
15	Spannwerkzeug	MOT1384
16	Spannwerkzeug	MOT1312



Motor/Kühlung/Klima

V4283, EAN 4047728042833

Motoreinstell Werkzeug-Satz BMW

- Für Vierzylinder-Benzinmotoren mit 1.6, 1.8 und 2.0L Hubraum und Doppelnockenwellen

Zum Durchführen folgender Arbeiten:

- Zum Arretieren der Nockenwelle und Kurbelwelle
- Zum Einstellen der Nockenwellenverstellung
- Zur Montage und Demontage der Nockenwelle sowie der variablen Nockenwellen-Einheit (Doppel Vanos)

• Geeignet für BMW:

- 1er: E81, E87
- 3er: E46, E90, E91
- 5er: E60, E61
- X3: E83
- Z4: E85

• Beispiele für Motorcodes:
N42, N46 und N46T

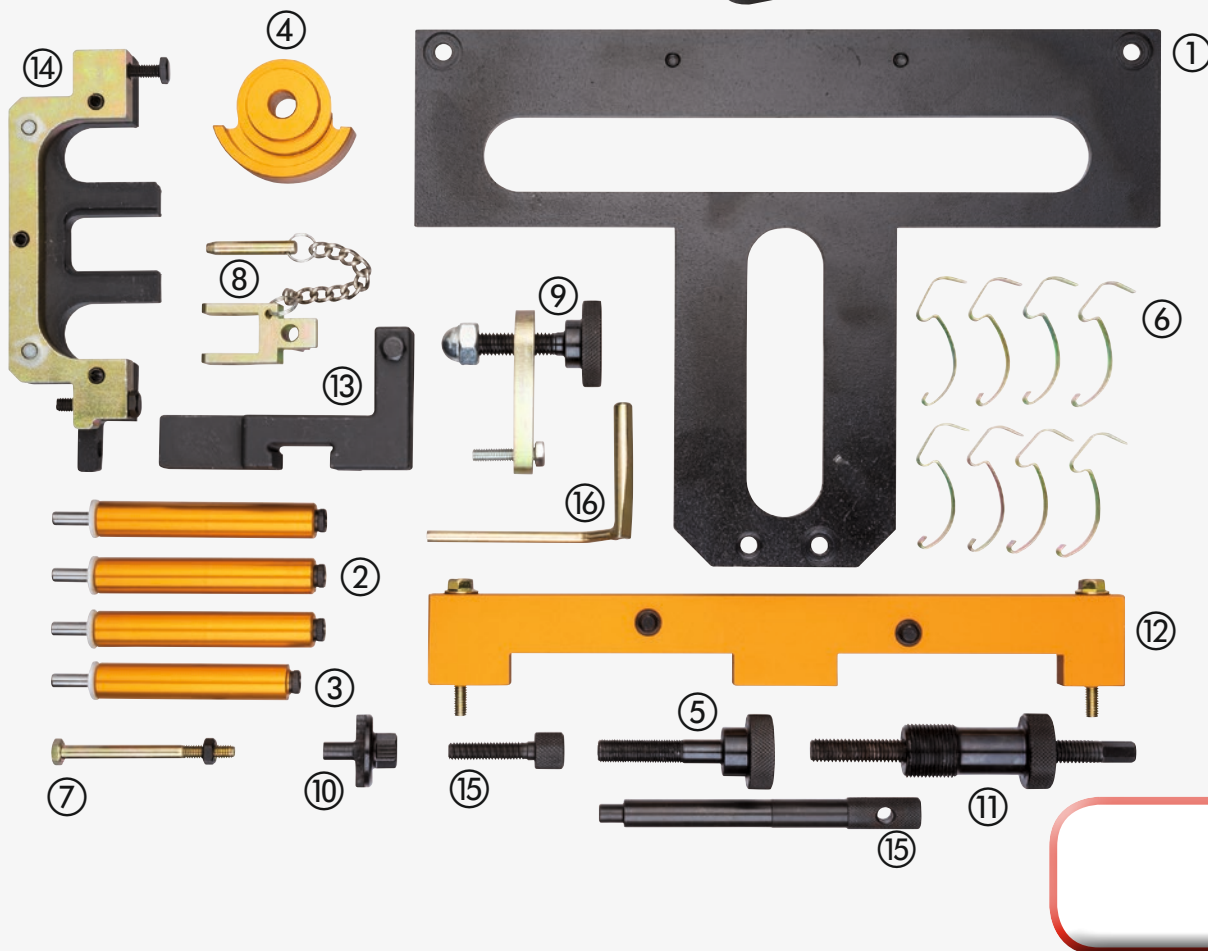

NR.	Bezeichnung	OEM-Nr.	NR.	Bezeichnung	OEM-Nr.
1	Lagerbrücken Aufnahme	11 9 320	9	Exzenterwellenhalter	11 9 301
2	Langer Stehbolzen 3 Stk	11 9 320	10	Nockenwellendreh Schlüssel	11 9 270
3	Kurzer Stehbolzen 1 Stk	12 9 320	11	Spannwerkzeug	11 9 340
4	Fixierwerkzeug Exzenterwelle	11 9 302	12	Fixierleiste Geberräder	11 9 350
5	Rändelschraube	11 9 302	13	Fixierwinkel Nockenwelle	11 9 292
6	Zwischenhebelklammern 8 Stk	11 9 310	14	Fixierbrücke Nockenwelle	11 9 291
7	Stützschraube mit Mutter	11 9 390	15	Fixierschraube 2 Stk	11 9 293
8	Drehfedernhalter	11 9 390	16	Abs Steckdorn, abgewinkelt	11 9 190

V4284, EAN 4047728**042840**

Motoreinstell Werkzeug-Satz BMW

• Für Arbeiten an 1.6L Benzinmotoren

Zum Durchführen folgender Arbeiten:

- Montage und Demontage der Nockenwellen
- Wechseln der Steuerkette
- Erneuern der Zylinderkopfdichtung
- Einstellen der Vanos-Verstelleinheit
- Vorspannen des Kettenspanners

• Geeignet für BMW:

1er: E87
3er: E46, E90

• Beispiele für Motorcodes:

N40, N45, N45T

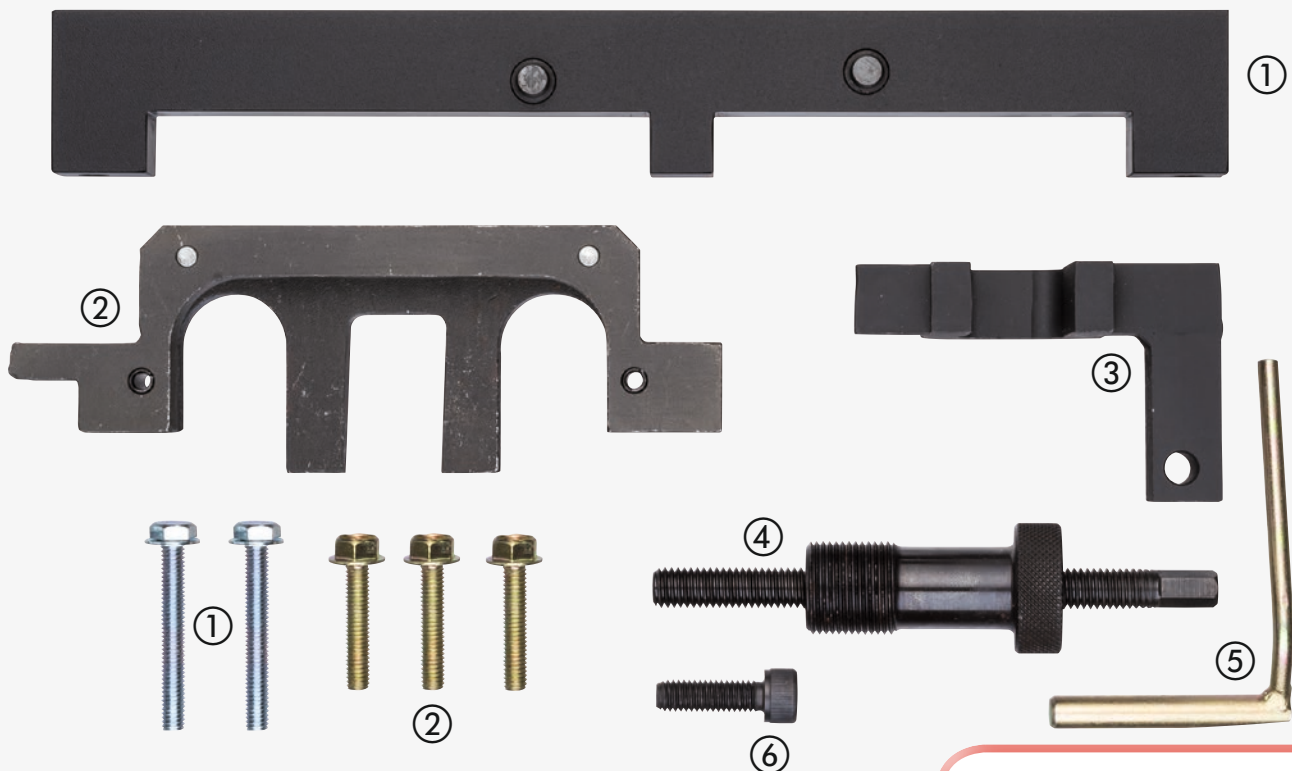

NR.	Bezeichnung	OEM-Nr.
1	Nockenwellen-Geberräder-Fixierung , inkl. 2 Schrauben M6x55 mm	11 7 260
2	Auslass-Nockenwellen-Fixierung, inkl. 2 Schrauben M6 x30 mm	11 7 251
3	Einlass-Nockenwellen-Fixierung inkl. 1 Schraube M6 x30 mm	11 7 252
4	Spannwerkzeug	11 9 340
5	Absteckdorn Kurbelwelle	11 9 190
6	Rändelschraube M8x25 mm	11 7 253

V4282, EAN 4047728042826

Motoreinstell Werkzeug-Satz VAG

• Für Arbeiten an Diesel- und Benzinmotoren mit unterschiedlichen Hubräumen

Zum Durchführen folgender Arbeiten:

- Erneuern des Zahnriemens und der Wasserpumpe (Entfallen von Einstellen des Haubenschlusses und Spaltmaße)
- Arretierung des Kurbelwellen-Zahnriemenrades bei TDI Pumpe-Düse Motoren (VAG: 1,2L / 1,4L und 1,9L)
- Arretierung des ovalen Kurbelwellen-Zahnriemenrades bei TDI Pumpe-Düse Motoren oder bei Motorreparaturen (VAG: 1,9L und 2,0L)
- Arretierung der Zahnriemen-Spannvorrichtung bei TDI Pumpe-Düse Motoren (VW, AUDI, SEAT und SKODA)
- Arretierung des Einspritzpumpenrades bei TDI Motoren ohne Pumpe-Düse sowie zur Positionierung der Nockenwelle bei Pumpe-Düse Motoren (VAG)
- Arretierung der Nockenwelle mit konventioneller TDI-Technologie (VAG)
- Ermöglicht Zahnriemen-Erneuerung ohne Demontage von Ansaugrohr und Ventildeckel
- Arretierung beider Nockenwellen bei Benzinmotoren (1,4L und 1,6L: VW: Lupo, Polo, Golf, Bora / AUDI: A2)
- Arretierung der Kurbel- und Nockenwelle bei Arbeiten an der Motorsteuerung (V6 2,5 TDI, V8 2,5 TDI und 3,3 TDI bei VW und AUDI)
- Einstell-Lineal für Nockenwellen bei Diesel-Motoren (D, SD und TD)

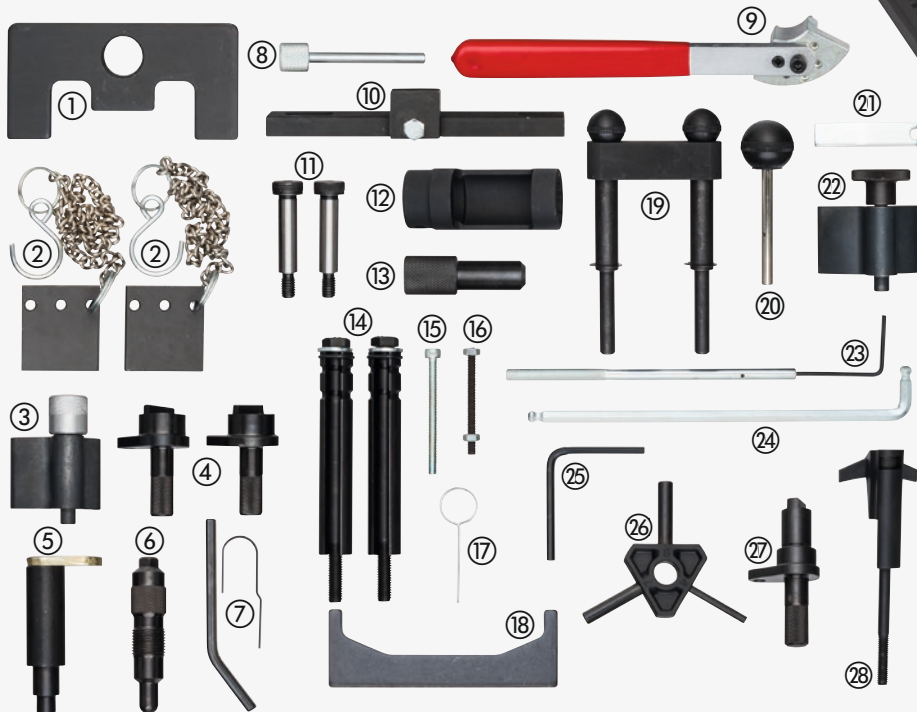

• Beispiele für Motorcodes:

ABM, ADA, ADP, AEH, AEK, AFT, AHL, AKL, AKS, ALZ, ANA, APF, ARM, AUR, AVU, AYD, BFQ, BFS, BGV, BSE, BSF, ABS, ADR, ADZ, AGN, AJP, APG, APT, APX, ARG, AEB, AGU, AJH, AJL, AJQ, AMK, ANB, APP, APU, APY, AQA, AQX, ARX, ARY, ARZ, AUM, AVC, AWC, AWT, AWU, AUQ, AYP, BAM, ADL, 2E, AAC, AAE, ABF, ABK, ABT, ACE, ADY, AEG, AGG, AKT, APK, AQY, ATM, ATU, AWF, AWG, AXA, AZH, AZJ, AZL, AZM, BEH, AHB, AHG, AKU, AKW, 1X, 1Y, AAZ, ABL, AEY, AGD, AGP, AQM, ASX, ASY, AYQ, AAZ, AFF, AFN, AGR, AHF, AHH, AHU, ALE, ALH, ASV, AVG, ANY, ANY, AYZ, AMF, ATL, BAY, BHC, BNM, BNV, AJM, AMG, ANU, ARL, ARX, ASZ, ATD, ATJ, AUY, AVB, AVF, AVQ, AWX, AXB, AXC, AXR, BEW, BJB, BKC, BKE, BLS, BLT, BPX, BRB, BRM, BRU, BSV, BSW, BTB, BVK, ANU, ASZ, AUY, AZV, BKD, BDJ, BDK, BGW, BHW, BKP, BLB, BMA, BMM, BMN, BMP, BMR, BNA, BPW, BRC, BRE, BRF, BRT, BSS, BUY, BUZ, BVE, BVF, BVG, BWV

! Nicht verwendbar als Gegenhalter beim Anziehen der Nockenwellen- und Kurbelwellenarretierungen

NR.	Bezeichnung	OEM-Nr.
1	Nockenwellen-Einstellehre	3418
2	Nockenwellen-Arretierung 2-flg.	3458
3	Arretierung Kurbelwellen-Zahnriemenrad oval	T10100
4	Arretierwerkzeug Nockenwellen 2-flg.	T10123
5	Arretierbolzen Kurbelwelle	T10121
6	Arretierdorn Kurbelwelle	3242
7	Arretierdorn Spannvorrichtung	-
7	Arretierdorn	-
8	Arretierdorn Einspritzpumpenrad	3359 / U-40074 / T20102
9	Spannrollenschlüssel, VAG ähnl.	T10020
10	Nockenwellen-Einstellehre	T10098A
11	Nockenwellen-Einstellschraube für Lehre 2-flg.	T10098A
12	Spezialsteckschlüssel 1/2", SW 22 mm, 12-kant	3078
13	Arretierdorn Einspritzpumpenrad	2064

NR.	Bezeichnung	OEM-Nr.
14	Servicestellung Frontmaske 2-flg.	3369
15	Sicherungsschraube Lüfterkupplung	-
16	Entlastungsbolzen Riemenspanner	T10092
17	Arretierdorn Spannvorrichtung	T40011
18	Nockenwellen-Einstellehre	2065A / U-40021
19	Arretierdorn Nockenwellen VAG T10016 / T10074 (ohne Brücke)	T10016 / T10014 / T10074 (ohne Brücke)
20	Absteckdorn Einspritzpumpenrad	3359 / T20102
21	Arretierung Spannvorrichtung	T10008 / 23-058 / 310-084
22	Arretierung Kurbelwellen-Zahnriemenrad	T10050 / 310-085 / 23-059
23	Arretierwerkzeug Spannrolle	T10265
24	Spezial Winkelschraubendreher SW 6 mm	T10264
25	Arretierdorn Spanneinheit	T10060A
26	Arretierdorn Kombination 4, 7 und 8 mm	-
27	Arretierwerkzeug Nockenwelle	T10120
28	Halter Kettenspanner	3366

V4346, EAN 4047728**043465**

Motoreinstell Werkzeug-Satz VAG 3 Zylinder Benzin

- Für VAG 1.2L, 3 Zylinder 6V und 12V Benzin-Motoren
- Zur Arretierung der Nocken- und Kurbelwelle

Zum Durchführen folgender Arbeiten:

- Arretierung der Kurbelwelle
- Arretierung der Nockenwelle
- Arretierung der Einspritzpumpenwelle
- Arretierung der Kurbelwellen-Riemenscheibe
- Spannen der Kette

• Geeignet für folgende Fahrzeuge:

- SEAT: Ibiza, Cordoba (Bj. 2002–2008)
- SKODA: Fabia, Roomster (Bj. 2002–2007)
- VW: Fox (Bj. 2005–2008), Polo (Bj. 2002–2007), Eos (Bj. 2006–2008)

• Beispiele für Motorcodes:

- AWY, AZQ, BBM, BME, BXV, BZG



Nr.	Bezeichnung	OEM-Nummer
1	Nockenwellen Justierwerkzeug-Satz 2-tlg.	T10123
2	Nockenwellen Justierwerkzeug	T10121
3	Fixierdorn für Kurbelwelle	T10120

V4372, EAN 4047728**043724**

Motoreinstell Werkzeug-Satz VAG 1.2L, 1.4L, 1.6L FSI / TSI / TFSI

- Gewinde M12 x 1,25 mm

• Geeignet für folgende Fahrzeuge:

- AUDI: A1 (Bj. 2010 - 2012)
- SEAT: Altea / Altea XL (Bj. 2008 - 2012), Ibiza / Cordoba (Bj. 2008 - 2012), Leon (Bj. 2007 - 2012), Toledo (Bj. 2007 - 2009)
- SKODA: Fabia II (Bj. 2007 - 2012), Octavia II (Bj. 2004 - 2012), Roomster (Bj. 2006 - 2012), Superb II (Bj. 2009 - 2012), Yeti (Bj. 2009 - 2012)
- VW: Caddy (Bj. 2010 - 2012), Eos (Bj. 2006 - 2012), Golf (Bj. 2003 - 2012), Golf Plus (Bj. 2003 - 2012), Jetta (Bj. 2006 - 2012), Passat (Bj. 2005 - 2011), Polo (Bj. 2002 - 2012), Scirocco (Bj. 2008 - 2012), Tiguan (Bj. 2007 - 2012), Touran (Bj. 2003 - 2012)

• Beispiele für Motorcodes:

- AXU, BAG, BKG, BLF, BLN, BLP, BMY, BTS, BLG, BWK, CAVA, CAVB, CAVC, CAVD, CAVF, CAXA, CAXC, CDGA



Nr.	Bezeichnung	OEM-Nummer
1	Arretierdorn Spannvorrichtung	T40011
2	Nockenwellen-Absteck-Werkzeug	T10171
3	Nockenwellen Arretierwerkzeug	T10414
4	Absteckbolzen Kurbelwelle	T10340
5	Messuhren-Halter Aufnahme 8,0 mm	T10170

V4373, EAN 4047728**043731**

Motoreinstell Werkzeug-Satz VAG 1.6L, 2.0L TDI Common Rail

Zum Durchführen folgender Arbeiten:

- Arretieren der Nockenwelle, Ausgleichswelle und Kurbelwelle
- Montage und Demontage der Nockenwellenräder
- Zahnriemenwechsel und Motorreparatur

• Geeignet für folgende Fahrzeuge:

VW: Golf 5 / 6 Plus, Polo, Jetta 5 / 6, Caddy 2, Beetle 2, Passat B6/ B7/ CC, Scirocco 3, Eos, Touran 3, Sharan 2, T5 und Amarock
 AUDI: A1, A3 (8P), A5, A6 (C6 + C7), TT (8J), Q3, Q5
 SKODA: Fabia 2, Roomster, Praktik, Octavia 2, Superb 2, Yeti
 SEAT: Ibiza (6J), Leon 3, Exeo, Altea, Alhambra 2



Nr.	Bezeichnung	OEM-Nummer
1	Spezial Winkelschraubendreher SW 6	T10264
2	Arretierwerkzeug Spannrolle	T10265
3	Absteckdorn Riemenspanner	T40098
4	Nockenwellenrad Gegenhalter	T10051
5	Ölpumpen Ausgleichswelle	T10255



9

NEU

• Beispiele für Motorcodes:

CAYA, CAYB, CAYC, CAGA, CAGB, CAGC, CAHA, CAHB, CBAA, CBAB, CABC, CBBA, CBBB, CBDA, CBDB, CBDC, CBEA, CEGA



Nr.	Bezeichnung	OEM-Nummer
6	Einsteckdorn Einspritzpumpenrad	T20102 / 3359
7	Nockenwellenrad Abzieher	T10052 + (6610-09)
8	Arretierung Kurbelwelle-Zahnriemenrad oval	T10100
9	Arretierung Kurbelwellen-Zahnriemenrad	T10050

V4424, EAN 4047728**044240**

Nockenwellen Anpassung VAG 1.8L, 2.0L TFSI-Motoren

Zum Durchführen folgender Arbeiten:

- Montage und Demontage des Nockenwellenventils an Nockenwellenverstellung
- Steuerkettenwechsel oder der Motorreparatur

• Geeignet für folgende Fahrzeuge:

AUDI: A3 (Bj. 2003-2004), A4 (Bj. 2007-2013), A5 (Bj. 2007-2013), Q5 (Bj. 2007-2013), TT (2008-2013)
 VW: Passat (Bj. 2006), Passat CC (Bj. 2009)

• Beispiele für Motorcodes:

CABA, CABB, CAWB, CDAA, CDAB, CDHB, CBFA, CCTA, CCZA, CDAH, CDNB, CDNC



Nr.	Bezeichnung	OEM-Nummer
1	Nockenwellen-Ventil-Werkzeug	T10352/1
2	Nockenwellen-Ventil-Werkzeug	T10352
3	Nockenwellen-Ventil-Werkzeug	T10352/2



3

NEU

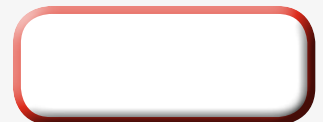

V4374, EAN 4047728**043748**

Motoreinstell Werkzeug-Satz VAG 2.0L FSI / TFSI und TFSI Turbo

- Geeignet für folgende Fahrzeuge:
AUDI: A3, A4, A6, S3, TT
VW: Golf, Golf Plus, Jetta, EOS, Touran
(ab Bj. 2003–2010), Passat SKODA: Oktavia 2



7

NEU

- Beispiele für Motorcodes:
AWA, AXW, AXX, BGB, BHD, BHZ, BLR, BLX, BLY, BMB, BPG, BPE, BPJ, BPY, BUL, BVX, BZY, BVZ, BWA, BWE, BWJ, BWT, BYD, BYK, BZC, CDLA, CDLB, CDLC, CDLD, CDMA

Nr.	Bezeichnung	OEM-Nummer
1	Spannröllenschlüssel gekröpft	T10020
2	Arretierdorn Spannvorrichtung	T40011
3	Nockenwellenblockierwerkzeug	T10252
4	Arretierdorn Spanneinheit	T10060A

Nr.	Bezeichnung	OEM-Nummer
5	Absteckdorn	T10115
6	Halter Kettenspanner	3366
7	Spanschraube Riemenpanner	T10092

V4371, EAN 4047728**043717**

Motoreinstell Werkzeug-Satz VAG 2.4L, 3.2L FSI

- Für Arbeiten an AUDI 2.4L / 3.2L FSI V6, V8 und V10 Benzin-Motoren

- Zum Durchführen folgender Arbeiten:
- Arretieren der Nocken- und Kurbelwelle
- Fixieren der Kettenspanneinheit
- Wechseln der Steuerkette
- Einstellen der Steuerzeiten bei Motorreparaturen
- Unter anderem geeignet für folgende Fahrzeuge:
AUDI A4, A6 der Baureihe B7 und C6



5

NEU

- Beispiele für Motorcodes:
AUK, BDW, BGP, BGQ, BKH, BPK, BYU, BVJ, BNS, BYH, CAUA, BXA, BSM

Nr.	Bezeichnung	OEM-Nummer
1	Nockenwellenblockierung 2-llg.	T40070
2	Drehadapter für Kurbelwelle	T40058
3	Kurbelwellenabsteckdorn	T40069
4	Kettenspanner Fixierdorn	T40071

V4375, EAN 4047728043755

Motoreinstell Werkzeug-Satz VAG 2.7L, 3.0L V6 TDI Common Rail

Zum Durchführen folgender Arbeiten:

- Arretieren der Ausgleichswellen
- Arretieren der Nocken- und Kurbelwelle
- Fixieren der Kettenspanneinheit
- Wechseln der Steuerkette
- Einstellen der Steuerzeiten bei Motorreparaturen

- Geeignet für folgende Fahrzeuge:
VW: Touareg, Phaeton
AUDI: A4, A5, A6, A8, Q5, Q7

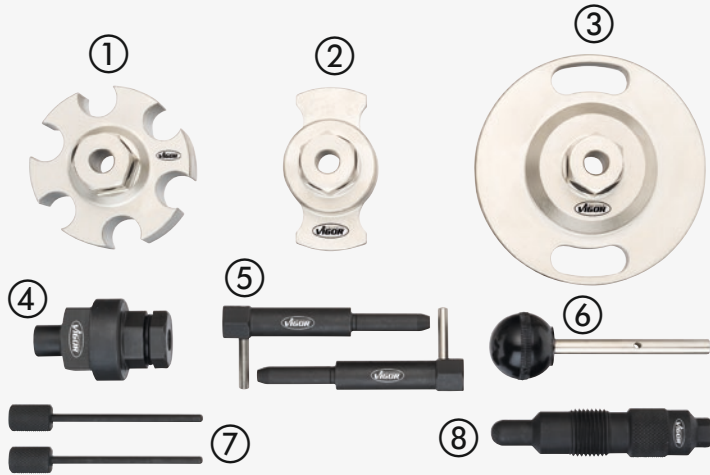

Nr.	Bezeichnung	OEM-Nummer
1	Nockenwellenwerkzeug	T40061
2	Nockenwellen Blockierung	T40062
3	Drehadapter Kurbelwelle	T40049
4	Drehadapter Kurbelwelle	T40058



10

NEU

• Beispiele für Motorcodes:

- ASB, BKN, BKS, BMK, BMZ, BNG, BPP, BSG, BUG, BUN, CAMA, CAMB, CANA, CANB, CANC, CAND, CAPA, CARA, CARB, CASA, CASB, CASC, CATA, CCMA, CCWA, CCWB, CDYA, CDYB, CDYC, CEXA, CGKA, CGKB



Nr.	Bezeichnung	OEM-Nummer
5	Nockenwellen-Blockierdorne 2x	T40060
6	Absteckdorn Einspritzpumpenrad	3359
7	Kettenspanner Arretierung 2x	
8	Arretierdorn Kurbelwelle	3242

V4423, EAN 4047728044233

Motoreinstell Werkzeug-Satz Audi 3.0L V6 Benzin-Motoren

Zum Durchführen folgender Arbeiten:

- Arretieren der Nockenwellen und Kurbelwelle
- Zahnriemenwechsel oder Motorreparatur
- Positionieren der Zahnriemenspanneinheit

- Geeignet für folgende Fahrzeuge:
AUDI: A4 / A4 Cabrio, A6, A8

- Beispiele für Motorcodes:
ASN, AVK, BBJ



Nr.	Bezeichnung	OEM-Nummer
1	Spannrollen Justierer	3387
2	Nockenwellenblockierung 2x	T40030
3	Absteckdornsatz Spannrolle	T40011



6

NEU



Nr.	Bezeichnung	OEM-Nummer
4	Steckschlüssel Nockenwellenversteller	T40028
5	Kurbelwellen Blockierdorn	T40026

V4347, EAN 4047728043472

Motoreinstell Werkzeug-Satz VAG 1.2L, 1.4L und 1.9L PD

Zum Durchführen folgender Arbeiten:

- Arretierung des runden Kurbelwellen-Zahnriemenrades
- Abstecken der Einspritzpumpe
- Blockieren der Spannrolle
- Geeignet für: VW, AUDI, SKODA, SEAT

Beispiele für Motorcodes:

ANY, AYZ, AMF, ATL, BAY, BHC, BNM, BNV, AJM, AMG, ANU, ARL, ARX, ASZ, ATD, ATJ, AUY, AVB, AVF, AVQ, AWX, AXB, AXC, AXR, BEW, BJB, BKC, BKE, BLS, BLT, BPX, BRB, BRM, BRU, BSV, BSW, BTB, BVK, ANU, ASZ, AUY, AZV, BKD, BDJ, BDK, BGW, BHW, BKP, BLB, BMA, BMM, BMN, BMP, BMR, BNA, BPW, BRC, BRE, BRF, BRT, BSS, BUY, BUZ, BVE, BVF, BVG, BVH, BWV



V4348, EAN 4047728043489

Motoreinstell Werkzeug-Satz VAG 1.9L, 2.0L PD

Zum Durchführen folgender Arbeiten:

- Arretierung des ovalen Kurbelwellen-Zahnriemenrades
- Abstecken der Einspritzpumpe
- Blockieren der Spannrolle
- Geeignet für: VW, AUDI, SKODA, SEAT

Beispiele für Motorcodes:

AZV, BKD, BDJ, BDK, BGW, BHW, BKP, BLB, BMA, BMM, BMN, BMP, BMR, BNA, BPW, BRC, BRE, BRF, BRT, BSS, BUY, BUZ, BVE, BVF, BVG, BVH, BWV



Nr.	Bezeichnung	OEM-Nummer
1	Arretierung Kurbelwellen-Zahnriemenrad	T10050
2	Arretierung Spannvorrichtung	T10008
3	Absteckdorn Einspritzpumpenrad 2-fig.	3359

Nr.	Bezeichnung	OEM-Nummer
1	Arretierung Kurbelwellen-Zahnriemenrad oval	T10100
2	Arretierung Spannvorrichtung	T10008
3	Absteckdorn Einspritzpumpenrad	3359

V4282-9, EAN 4047728043496

Spannrollenschlüssel VAG

- Flexibler Kopf (180° verstellbar) mit Feststellschraube
- Passend für VAG 4- und 5-Zylinder TDI Motoren sowie Servopumpe beim T4

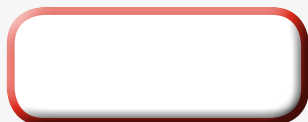
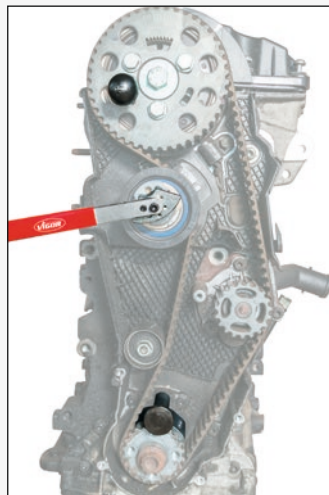

Nr.	Bezeichnung	OEM-Nummer
1	Spannrollen-Schlüssel	T10020

V4282-19, EAN 4047728043502

Nockenwellen-Arretierwerkzeug VAG

- Zur Arretierung beider Nockenwellen bei VAG 1.4L und 1.6L Motoren

Geeignet für folgende Fahrzeuge:

AUDI: A3
VW: Lupo, Polo, Golf, / Plus, Caddy, Beetle, Bora
SKODA: Fabia I und II, Octavia I und II, Roomster
SEAT: Arosa, Ibiza, Cordoba, Leon, Toledo, Inca

Beispiele für Motorcodes:

AFK, AHW, AJV, AKQ, APE, AQQ, ARC, ARR, ATN, AUA, AUB, AUS, AVY, AXP, AZD, BAD, BBY, BBZ, BCA, BCB, BKY, BUD, BXW



Nr.	Bezeichnung	OEM-Nummer
1	Arretiervorrichtung Nockenwelle	T10016 / 10074 (ohne Brücke)

V1963, EAN 4047728019637

Kühlersystem-Diagnose-Satz



- Kompletter Satz für Servicearbeiten am Kühlsystem und an der Heizung
- Umfangreiche Adapterauswahl passend für alle gängigen Fahrzeuge mit wassergekühlten Motoren
- 3 Funktionen: Kühler abdrücken (Kontrolle auf Undichtigkeiten), befüllen und reinigen
- Druckverlustkontrolle über Manometer
- Befüllen erzeugt Vakuum im Kühlkreislauf. Vorteil: Blasenfreies Einsaugen der Flüssigkeit
- Problemlose Befüllung auch größerer Motoren ohne thermische Schwachpunkte
- Füllsystem universell adaptierbar durch konischen Gummianschluss-Stutzen
- Messbereich: 0 bis 2,5 bar
- Für schwer erreichbare Stellen, optional kombinierbar mit 90° Adapter V4471



2 Adapter

- Inhalt:
- 1 Handpumpe mit Manometer · Schlauch · Druckablass-Ventil
- 1 Deckel-Prüfadapter, schwarz, R123 · R124
- 1 Deckel-Prüfadapter, blau, R123 · R125
- 1 Kühlsystem-Bajonettadapter Nr. 3, groß
- 1 Kühlsystem-Bajonettadapter Nr. 5, klein
- 13 Kühlsystem-Schraubadapter mit Innengewinde
M42 x 2,5 · M42 x 3,0 · M45 x 3,0 hohl · M45 x 3,0 · M46 x 3,0 · M48 x 2,5 · M48 x 4,0 · M50 x 2,5 · M50 x 2,5 hohl · M50 x 3,0 · M52 x 3,0 · M52,2 x 3,0 · M60 x 4,0 mm
- 3 Kühlsystem-Schraubadapter mit Außengewinde
M34 x 3,0 · M58 x 3,0 · M62 x 3,0 mm
- 1 Vakuum-Fülleinheit mit Manometer bis 76 cm HG = 1 bar
- 1 Gummikonus-Adapter, 45 - 14 mm, Länge: 75 mm
- 1 Thermometer, 0 - 220° C · 0 - 400° F

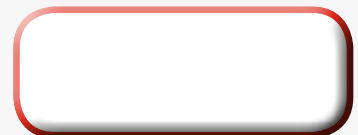

V4257, EAN 4047728042574

Kühlsystem-Schraubadapter M45 x 3,0

- Für BMW Mini (- 2008)
- Bereits im Satz V1963 enthalten



V4258, EAN 4047728042581

Kühlsystem-Schraubadapter M52,5 x 3,0

- Für :
- Chevrolet
- Fiat: Chroma
- Ford
- Isuzu
- Opel: Astra, Meriva, Zafira,
- Signum
- Saab
- Suzuki
- Bereits im Satz V1963 enthalten



V4202, EAN 4047728042024

Vakuum-Befülleinheit

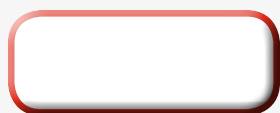

V3729, EAN 4047728037297

Handpumpe mit Manometer

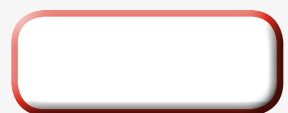

V3596, EAN 4047728**035965**

Kühlsystem-Diagnose-Satz Nfz

- Sortiment mit Pumpe und 7 Kühleradaptern
- Geeignet für gängige Lkw von DAF, IVECO, MERCEDES-BENZ, MAN, SCANIA, RENAULT und Volvo
- Messbereich: 0–2,5 bar
- Druckverlustkontrolle über Manometer
- Prüfmöglichkeit von Verschlusskappen
- Druckprüfung des Kühlsystems
- Für schwer erreichbare Stellen, optional kombinierbar mit 90° Adapter V4471
- Inhalt:
 - 1 Pumpe
 - 1 Schlauch
 - 1 Adaptersatz
 - 7 Adapter

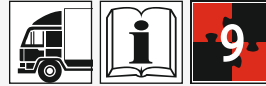

M42 x 3.0

M45 x 3.0

M52 x 3.0

M45 x 4.0

M62 x 4.0

M72 x 4.0

V4471, EAN 4047728**044714**

90° Adapter

- Für Fahrzeuge, bei denen aus Platzgründen eine Druckverlustkontrolle mit Standard-geraden-Adapter nicht möglich ist, Fahrzeug-Beispiel: Volvo FH12, Bj. 2001
- 90° Adapter nur kombinierbar mit VIGOR-Produkten V3596 und V1963
- Abdichtung mit Dichtmaterial, zum Beispiel Teflonband, empfohlen

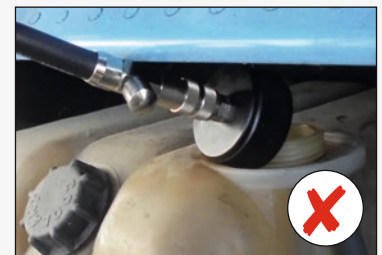

V2459, EAN 4047728024594

Refraktometer

- Zur schnellen und präzisen Überprüfung des Frostschutzgehaltes
- Anwendbar u.a. für Kühl- und Scheibenwasser, Batteriesäure und AdBlue
- Einstellbares Okular mit Gummi-Augenauflege
- Linke Skala:
Kontrolle der Batteriesäuredichte Messbereich 1100 bis 1300 sg / Auflösung 0,01 sg
- Mittlere Skala:
Frostschutz auf Basis Propylenglykol G 13 Messbereich -25° C bis -50° C / Auflösung 5° C
sowie Frostschutz auf Basis Ethylenglykol G 11/ G 12 Messbereich -25° C bis -50° C / Auflösung 5° C
- Rechte Skala oben:
AdBlue (VRA) Harnstoffgehalt Messbereich 30 % bis 35 % / Auflösung 0,1 %
- Rechte Skala unten:
Frostschutz-Scheibenwaschflüssigkeit SRF 1 Messbereich -10° C bis -40° C / Auflösung 1° C
- In Kunststoffbox mit Weichschaum-Einlage
- Inhalt:
1 x Refraktometer
1 x Kalibrier-Schraubendreher
1 x Pipette



V1586, EAN 4047728015868

Frostschutz-Prüfer

- Für Ethylenglykol-Wassermischungen an Kühlkreisläufen in Pkw, Lkw usw.

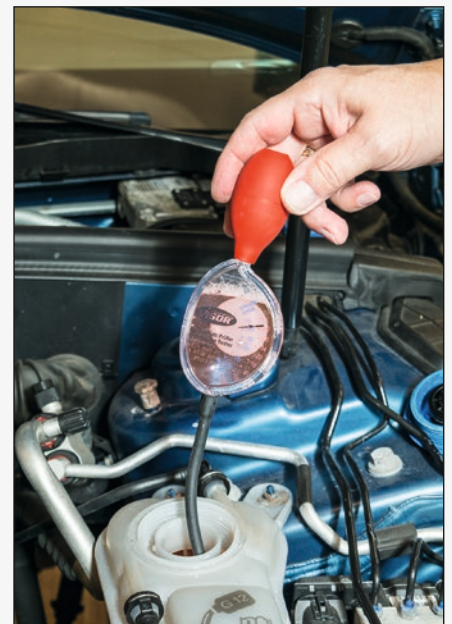

V2704, EAN 4047728**027045**

Injektorschacht-Reinigungs-Satz

- Universal Injektor-Dichtsitz-Reinigung- und Fräsen-Satz
- Zur Verwendung an HDI-, Diesel-Direkteinspritzung und Common-Rail-Motoren mit Bosch- und Delphi-Injektoren
- Schaffreinigung durch Bürsten mit Maschinenantrieb



NR.	VIGOR No.	Bezeichnung	mm	X	EAN 4047728+	NR.	VIGOR No.	Bezeichnung	mm	X	EAN 4047728+
1	V3604	Grundgerät	267	1	036047	7	V3577	Antriebsstück	107	1	035774
2	V3572	Unterlegscheiben-Dichtungsring	230	1	035729	8	V3578	Gewindespule M5x0,8 mm	15,2	6	035781
3	V3573	Adapter	294	1	035736	9	V3579	Adapter Ø 20,6 mm	32	1	035798
4	V3574	Bürste	300	1	035743	10	V3580	Adapter Ø 22 mm	32	1	035804
5	V3575	Bürste	85	1	035750	11	V3591	Adapter Ø 24,5 mm	32	1	035910
6	V3576	Gewindestange	200	1	035767	12	V3592	Fräser Ø 15/17 mm	39	1	035927
						13	V3593	Fräser Ø 19/17 mm	39	1	035934
						14	V3594	Fräser Ø 17 mm	39	1	035941

V2835, EAN 4047728028356

Lichtmaschinen Steckschlüssel-Satz

- Für Arbeiten an Lichtmaschine im ein- und ausgebauten Zustand
- Z.B.: VW, AUDI, SEAT, SKODA, PORSCHE, MERCEDES-BENZ, FORD, RENAULT, Volvo usw.
- Zur Demontage und Montage der Freilauf-Riemenscheibe an Lichtmaschinen
- TORX®- und XZN-Einsätze für unterschiedliche Innenprofile
- Zur Arretierung der Lichtmaschine über jeweiligen Einsatz und Verschraubung der Riemenscheibe über Vielzahnadapter

29

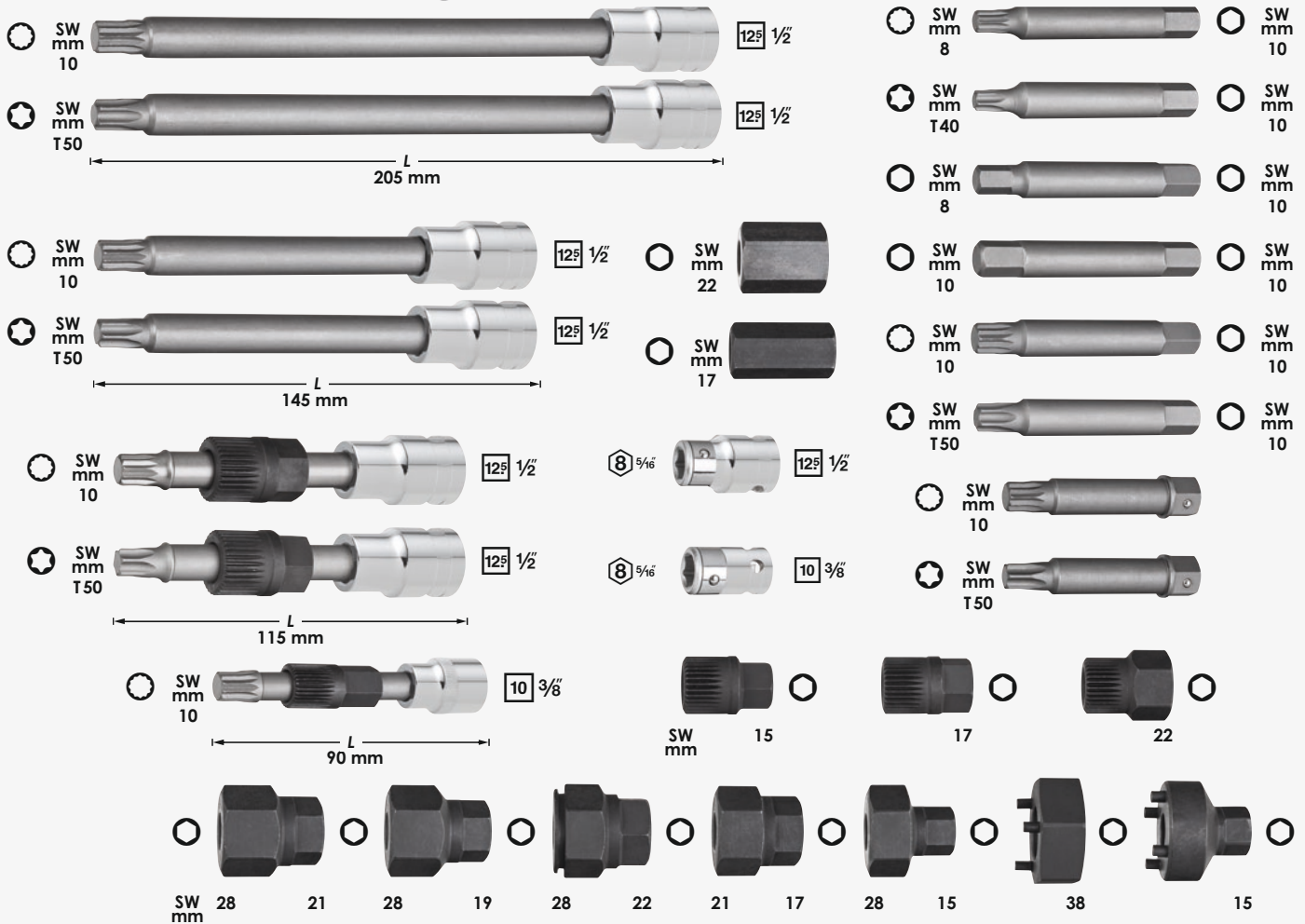

V4192, EAN 4047728**041928**

Turbosystem-Abdrücker-Satz für Klicksysteme

- Zur schnellen Diagnose der Ladeluft-Systeme in neuen Fahrzeuggenerationen, bei denen Luftröhre mit Klicksystem verbunden werden
- Ermöglicht zeitsparende und fachgerechte Ermittlung von undichten Ladeluftschläuchen
- Zur Durchführung der Dichtheitsprüfung anhand von Geräuscentwicklung, Lecksuchspray oder Druckabfall
- Inhalt:
6 Stopfen-Paare 31 / 38 / 46 / 51 / 56 / 61 mm



Ohne Manometer



V4233, EAN 4047728**042338**

Manometer für Turbosystem-Abdrücker-Satz

Geeignet für V3595, V4192 und für V4331





Motor/Kühlung/Klima

V4304, EAN 4047728043045

Turbo-System Abdrücker-Satz für Kfz

- Zur schnellen Diagnose des Ladeluftsystems
- Ermöglicht zeitsparende und fachgerechte Ermittlung von undichten Ladeluftkühlern und nicht sichtbaren Rissen in Ladeluftschläuchen
- Inhalt:
1 Druckschlauch mit Manometer und Ausgleichsventil
6 Paar abgestufte Adapter:
31/38, 46/51, 55/60, 65/70, 75/80, 85/90 mm

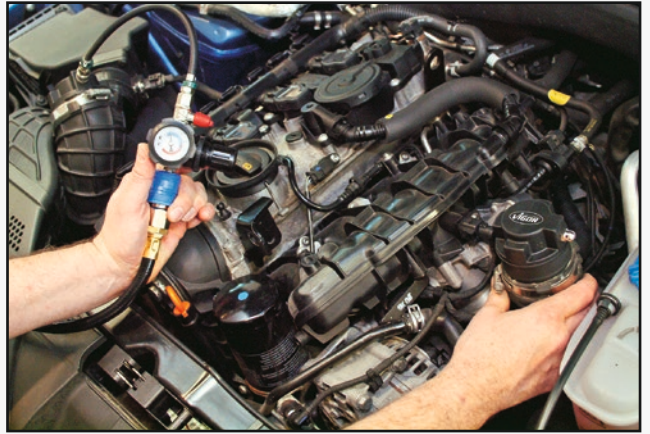

Inkl. Manometer



31/38 mm



46/51 mm



55/60 mm



65/70 mm



75/80 mm



85/90 mm



V4305, EAN 4047728043052

Adapter 31/38 mm

- Zur Nutzung mit Manometer V4233 zum Test des Turbo-Systems
- Z.B als Erweiterung des Turbosystem-Abdrücker-Satzes V3595 möglich



V4306, EAN 4047728043069

Adapter 46/51 mm

- Zur Nutzung mit Manometer V4233 zum Test des Turbo-Systems
- Z.B als Erweiterung des Turbosystem-Abdrücker-Satzes V3595 möglich



V4331, EAN 4047728**043311**

Turbo-System Abdrücker-Satz für Nfz

- Zur schnellen Diagnose des Ladeluftsystems
- Ermöglicht zeitsparende und fachgerechte Ermittlung von undichten Ladeluftkühlern und nicht sichtbaren Rissen in Ladeluftschläuchen
- Inhalt:
1 Druckschlauch mit Manometer und Ausgleichsventil
3 Paar abgestufte Adapter
105/110, 115/120, 125/130 mm

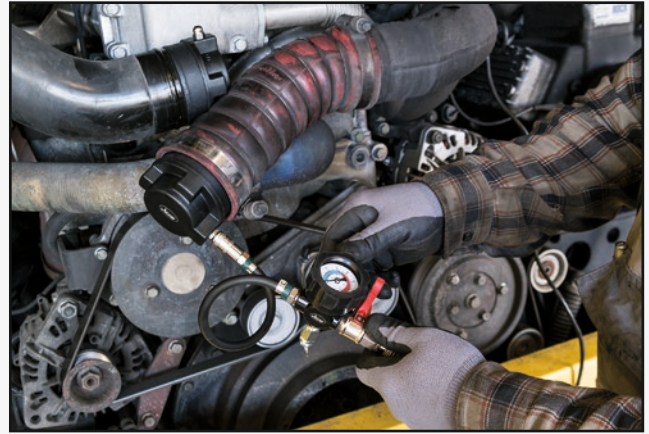

Inkl. Manometer



105 / 110 mm



115 / 120 mm



125 / 130 mm



B



B



B

V4325, EAN 4047728043250

Vakuum- und Druckpumpen-Satz

- Insbesondere zum Überprüfen von Druck- und Unterdrucksystemen u.a. geeignet für:
 - Ladedruck
 - Unterdruck-Magnetventilen
 - MAP-Sensoren
 - Tankbelüftungen
 - Bremsleitungs-Systeme
- Inklusive umfangreichem Adapter-Sortiment



**Auch geeignet
für Bremsleitungs-
Systeme**



Schlauchlänge:
630 mm



Anzeigebereich: -1 bis 4 bar
Unterdruckanzeige-Bereich: von -1 bis 0 bar
Max. Druck: bis 3 bar
Max. Unterdruck: bis 0,7 bar



Robuste Metall-
ausführung



Füllmenge:
120 ml

V4461, EAN 4047728**044615**

Kompressions- und Druckverlusttester Satz

- Für Diesel- und Benzinmotoren
- Zur professionellen Prüfung von Kompression oder Druckverlust für die meisten Pkw-, Lkw-, Motorrad-, Bus-, Agrar- und Boots- Motoren sowie Hdi- TDCI- und Pumpe-Düse-Motoren
- Enthält Glühkerzenadapter für folgende Hersteller z.B.: ALFA, BMW, CHRYSLER, DAEWOO, FIAT, FORD, HYUNDAI, ISUZU, LAND ROVER, MAZDA, MERCEDES-BENZ, MITSUBISHI, NISSAN, OPEL, PSA, RENAULT, SAAB, SUZUKI, TOYOTA, VAG, VAUXHALL, Volvo, etc.
- Zündkerzenadapter M10, M12, M14, M18
- Kompressions-Druckprüfer: max. 50 bar
- Schnellkupplungen in gerader und abgewinkelter Ausführung
- Einspritzdüsen_Adapter M20, M22, M24 sowie für FORD Stanadyne Injektoren



V2112, EAN 4047728021128

Ölmesststäbe-Satz MERCEDES-BENZ

- Zum Messen des Motor- und Automatikgetriebe-Ölstandes
- Unverzichtbar nach Ölwechsel (Fahrzeugauslieferung werksseitig ohne Messstäbe, sondern nur mit Verschlussstopfen)

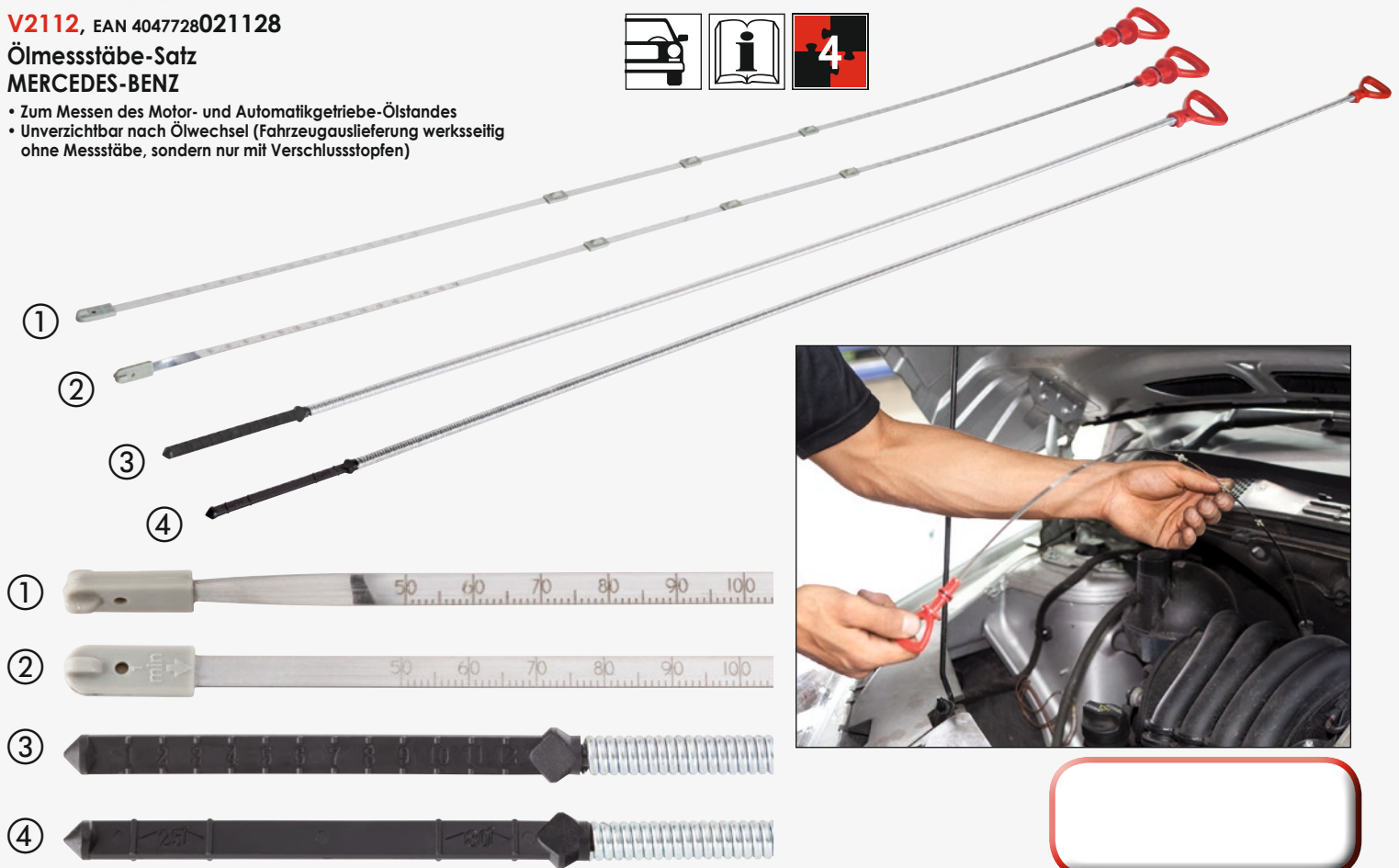

V2645, EAN 4047728026451

Ölmesststab AUDI

- Für Modelle mit Ölstandsanzeige im Display (kein Peilstab am Motor)
- Zum Kontrollieren des Füllstands nach Ölwechsel und anschließendem Vergleich mit Displayanzeige
- Hilfreich nach Tausch des Ölsensors oder Kalibrierung der Anzeige im Fahrerdisplay (vergleichbar T40178)
- Anwendung: u.a für AUDI A4 / A5 / A6 mit Motoren 1.8, 2.0 TFSI / 3.0, 3.2 FSI / 2.0, 2.7, 3.0 TDI

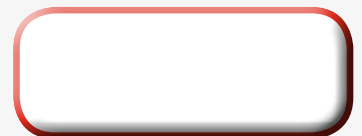
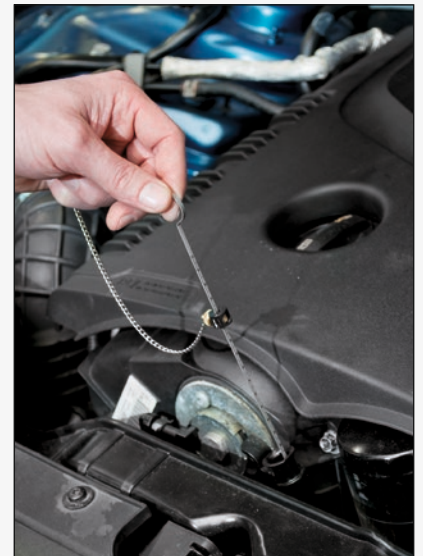
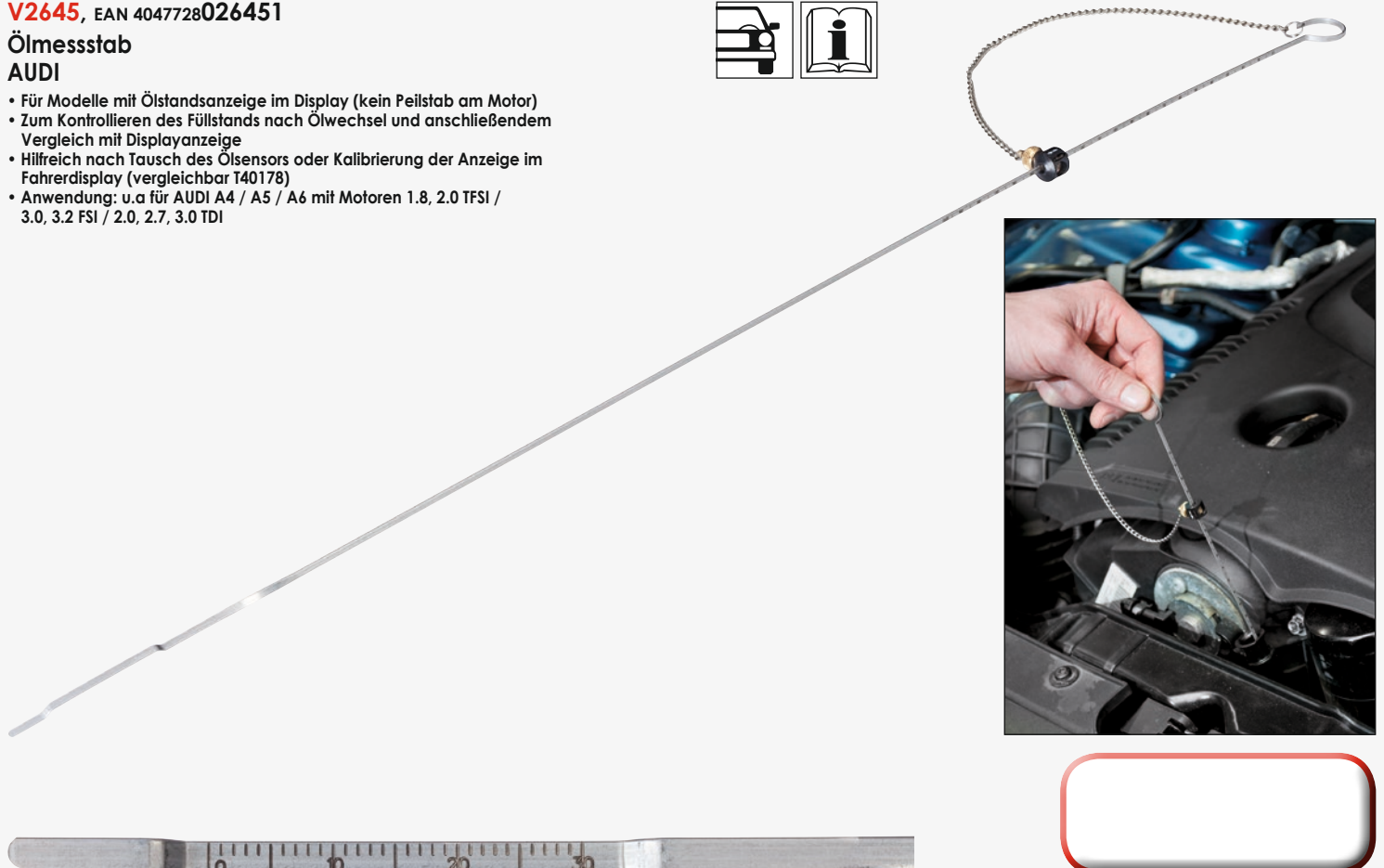

V1282, EAN 4047728012829

Ölfilterschlüssel-Satz

- 14 Ölfilterschlüssel
- 1 Adapter $10 \frac{3}{8}$ Außenvierkant / $1 \frac{1}{2}$ Innenvierkant, mit Außensechskant SW 21 mm



Ø mm	Stufe	Rillen	Fläche	Fahrzeuge
65	1	-	14	DAIHATSU, TOYOTA, NISSAN, FIAT
65-67	1	-	14	DAIHATSU, TOYOTA
68	1	-	14	MAZDA, FORD, SUBARU
73	1	-	14	TOYOTA, LEXUS
74-76	2	-	15	FORD, OPEL, VW, AUDI, MERCEDES-BENZ
75-77	2	-	15	VW, AUDI, ISUZU, MERCEDES-BENZ
76	-	-	14	VW, PORSCHE, MERCEDES-BENZ, BMW, AUDI, OPEL
76	1	30	-	FORD
80	1	-	15	NISSAN, HONDA, OPEL, MAZDA
80-82	2	-	15	SUBARU, TOYOTA, HONDA, NISSAN
90	1	-	15	HONDA, MITSUBISHI, ISUZU
93	1	-	15	MAZDA, Volvo, MITSUBISHI, NISSAN, HONDA
93	1	36	-	FORD
100	1	-	15	ISUZU, MITSUBISHI

V2511, EAN 4047728025119

Ölfilterbandschlüssel für den Pkw-Bereich



V2521, EAN 4047728025218

Ersatz-Spannband

V1281, EAN 4047728012812

Ölfilterkralle für Pkw

- Antrieb wahlweise:
- $10 \frac{3}{8}$ Innenvierkant,
- $1 \frac{1}{2}$ Innenvierkant oder
- SW 21 mm \bullet Außensechskant
- 1 Adapter $10 \frac{3}{8}$ Außenvierkant, $1 \frac{1}{2}$ Innenvierkant, mit Außensechskant SW 21 mm

$10 \frac{3}{8}$

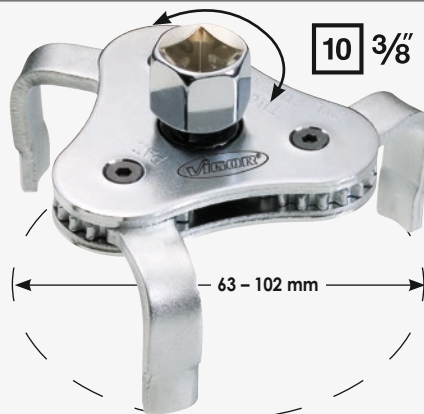

V4413, EAN 4047728044134

Universal Ölfilter-Spannschlüssel, 60–80 mm

- Stufenlos verstellbar, Spannungsbereich: 60–80 mm
- Einsatz mittels Schraubenschlüssel SW 21 oder $\frac{1}{2}$ Umschaltknarre
- Optimaler Halt beim Lösen des Ölfilters durch linksgezahnte Backen
- Gut geeignet für schwer zugängliche Filtergehäuse
- Anwendung im Rechts-/ Links-Betrieb ermöglicht Lösen und Anziehen der Schraubverbindung



V4414, EAN 4047728044141

Universal Ölfilter-Spannschlüssel, 80–115 mm

- Stufenlos verstellbar, Spannungsbereich: 80–115 mm
- Einsatz mittels Schraubenschlüssel SW 21 oder $\frac{1}{2}$ Umschaltknarre
- Optimaler Halt beim Lösen des Ölfilters durch linksgezahnte Backen
- Gut geeignet für schwer zugängliche Filtergehäuse
- Anwendung im Rechts-/ Links-Betrieb ermöglicht Lösen und Anziehen der Schraubverbindung



V4484, EAN 4047728**044844**

Spezial-Bit

- Zur Demontage und Montage der Kunststoff Ölablass-Schraube mit Spezialprofil an Ölwanne aus Kunststoff

- Geeignet für folgende Fahrzeuge:
AUDI, SEAT, SKODA, VW ab Bj. 2013 mit 1,2 · 1,4 · 1,8 · 2,0 l TFSI Benzin-Motoren
AUDI A1, A3, A4, A5, Q5,
VW Golf MK VII, VII,
SEAT Leon, etc. mit 1,6 und 2,0 l Diesel-Motoren



6.3 1/4"



V2681, EAN 4047728**026819**

30 l Mehrzweckwanne mit Rollen, extraflach

- Geeignet für Öl, Kühflüssigkeit etc.



V3306, EAN 4047728**033060**

Lkw-Achsölwanne

- Zur sauberen Demontage der Antriebswelle
- Passend für unterschiedliche Felgendurchmesser
- Spezial-Kunststoff

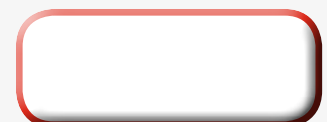

V4369, EAN 4047728043694

Vakuumpumpe 350 ml

- Geeignet zum Ansaugen und Umfüllen von Kraftstoffen, Ölen und anderen Flüssigkeiten
- Füllmenge: 350 ml

- Geeignet für u.a. folgende Flüssigkeiten:
 - Dieselmotoren
 - Benzin
 - Bremsflüssigkeit
 - Frostschutz
 - Motoröl
 - Getriebeöl
 - Servolenkungsl

- Inhalt:
 - 1 x Handpumpe 350 ml
 - 1 x PVC-Schlauch Ø 9,8 mm x 300 mm
 - 1 x Silicon-Schlauch Ø 11 mm x 300 mm
 - 1 x Tropfstopfen
 - 1 x Universal-Adapter



Skalenanzeige

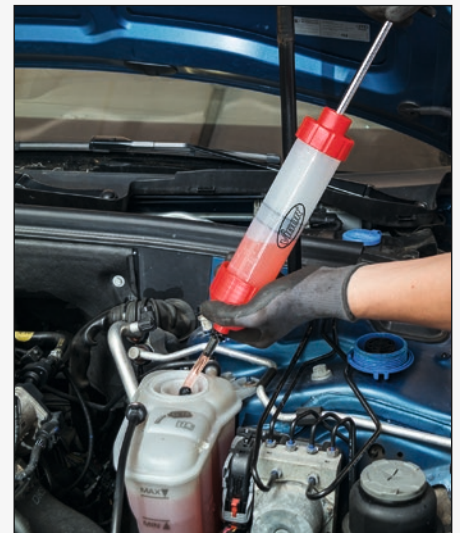
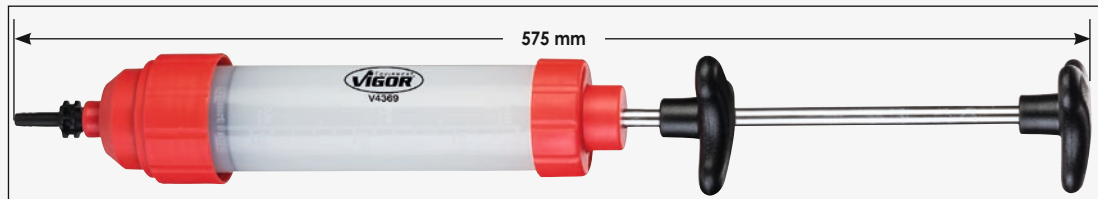

V2702, EAN 4047728027021

Ölablass-Schlauch

- Adapter öffnet beim Einschrauben in das Ölfiltergehäuse ein Ventil und gewährleistet dadurch kontrolliertes Abfließen des Öls aus Ölfiltergehäuse
- Nie mehr Kundenreklamationen auf Grund verölter Motoren
- Für VAG 1,8 l und 2,0 l Benzinmotoren mit Motorkennbuchstaben AXW / BLX / BLR / BLY / BVX / BVY BVZ bei:

- | | |
|-------|---|
| AUDI | A3 (8P1 / 8PA),
A4 (8EC / 8ED / 8H7 / 8HE),
A6 (4F2 / 4F5), TT (8J3 / 8J9), |
| SEAT | Altea (5P1 / 5P5),
Leon (1P1),
Toledo 3 (5P2), |
| SKODA | Octavia (1Z3 / 1Z5) |
| VW | Jetta 3 (1K2),
New Beetle (9C1 / 1C1 / 1Y7),
Golf 5 und Eos (1K1 / 5M1),
Passat (3C2 / 3C5),
Touran (1T1 / 1T2) |

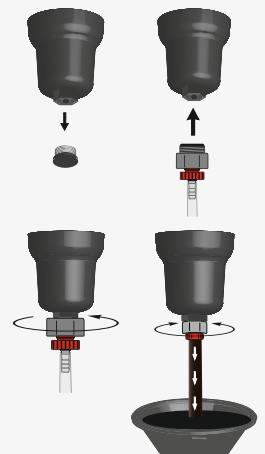

V4201, EAN 4047728**042017**

Vakuumpumpe 1,5 l

- Manuelle Vakuumpumpe zum Absaugen und Einfüllen von Fahrzeugflüssigkeiten
- Ebenfalls geeignet zum Vorbefüllen des Kraftstoff-filters, bei Fahrzeugen ohne Vorfilterpumpe z.B. beim 2.0L TDI FORD Galaxy und Mondeo
- Kapazität: 1,5 l

• Geeignet für folgende Flüssigkeiten:

- Dieselmotoren
- Benzin
- Bremsflüssigkeit
- Frostschutz
- Motoröl
- Getriebeöl
- Servolenkungsl



V4385, EAN 4047728**043854**

Öl-Einfüllgerät mit Adapter-Satz

- Zum Befüllen von Getrieben und Differentialen mit Öl
- Inkl. Ölwanne und 16 Adapter für Fahrzeuge mit extrem beengten Bauräumen



VIGOR No.	Bezeichnung	EAN 4047728+
V3681	Adapter FORD mit Gewindeanschluss	036818
V3682	Adapter BMW abgeknickt	036825
V3683	Adapter VAG kurz, abgeknickt	036832
V3684	Adapter VAG lang, abgeknickt	036849
V3685	Adapter VAG gerade, mit Gewindeanschluss	036856
V3686	Adapter MERCEDES-BENZ, 7-Gang Automatik	036863
V3687	Adapter VAG DSG Direktschaltgetriebe	036870
V3688	Adapter VAG CVT, stufenlose Automatik	036887
V3689	Adapter Volvo, gerade	036894
V3690	Adapter SKODA, M 18x1,5 mm	036900
V3691	Adapter VW Passat ab Bj. 2007	036917
V4113	Adapter TOYOTA, LEXUS 18x1,5	041133
V4115	Multifunktions-Adapter	041157
V4114	Adapter Infiniti 7 Speed M8x1,0 für V2670	041140
V4383	Adapter NISSAN Juke M12x1.25 mm	043830
V4384	Adapter für MINI Cooper M14x1.5 mm	043847



Jetzt NEU:
Größte Marktabdeckung

Inkl. 16 Adapter



Auch als Ersatzteil bestellbar



V3550, EAN 4047728**035507**

Ersatzbehälter für Öl-Einfüllgerät



V3679, EAN 4047728**036795**

Adapter-Satz zu V4385

V4412, EAN 4047728**044127**

Manuelle Vakuum- und Druckpumpe 6 l

- Manuelle Vakuum- und Druckpumpe mit 6 l Fassungsvermögen
- Geeignete mögliche Flüssigkeiten u.a. Motoröle, Getriebeöle, Bremsflüssigkeit, Schmierstoffe, Kühlflüssigkeiten, auch AdBlue geeignet
- Ebenfalls zur Verwendung von Kraftstoffen wie Benzin und Diesel geeignet
- Achtung: Diese Stoffe dürfen nur kurz in der Pumpe verbleiben!
- Inhalt: Pumpe inklusive 3 Sonden, Größe: 5,8 · 6,7 · 9,8 mm

NEU

4

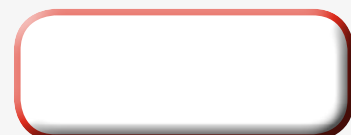

V2306, EAN 4047728023061

SAC-Kupplungswerkzeug-Satz

- Für nahezu alle selbstnachstellenden SAC-Kupplungen mit 3-Loch-Teilung
- Zur schnellen und fachgerechten Demontage und Montage der SAC-Kupplungen
- Korrekter Einbau nahezu unmöglich ohne diesen Werkzeugsatz
- Mit Zentriermöglichkeit der Kupplung und Rückstellen des Nachstellings
- Verhindert das Verdrehen des Nachstellrings in der Kupplungsdruckplatte
- Ideal für beschädigungsfreies Arbeiten an der Druckplatte
- Funktionsstörungen (schlechtes Trennen, Rutschen oder Rupfen) werden vermieden

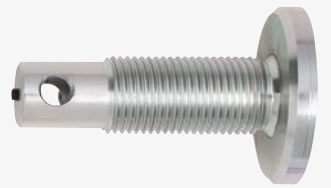

V2308, EAN 4047728023085

Erweiterung-Sortiment für SAC- Kupplungswerkzeug

- Zum Beispiel für MERCEDES-BENZ A-Klasse



V3228, EAN 4047728032285

ABS-Reibahlen-Satz

- Bestehend aus ausschließlich nach rechts drehender, feinverzahnter Gelenkknarre mit Schnellwechselfunktion, 5 Reibahlen sowie Spiralbohrer 10 mm \varnothing x 133 mm zum Ausbohren von korrodierten und somit festsitzenden Sensoren
- Hinweis: Beim Austauschen fehlerhafter ABS-Sensoren bleiben oft schwer zu entfernende Reste aufgrund abgerissener Sensoren zurück. Für ordnungsgemäßen Einbau neuer Sensoren, müssen die Sitze der Sensoren im Radlagergehäuse mit entsprechenden Reibahlen gereinigt werden



• 5 Reibahlen:

- V3695** Reibahle \varnothing 10 mm x 133 mm:
VW Golf 5, Polo 9N, T5, SKODA Fabia,
SEAT Ibiza, OPEL Insignia
- V3694** Reibahle \varnothing 14 mm x 32 mm:
BMW E38, E39, E52, E60, E61, E63, E64, E65, E66, E70, E71
- V3699** Reibahle \varnothing 15 mm x 23 mm:
MERCEDES-BENZ A-Klasse, MAZDA, FORD
- V3698** Reibahle \varnothing 18 mm x 23 mm:
AUDI, VW, BMW E36, E46, SEAT, SKODA
- V3697** Reibahle \varnothing 18 mm x 34 mm:
AUDI, VW, SEAT, SKODA, Nutzfahrzeuge

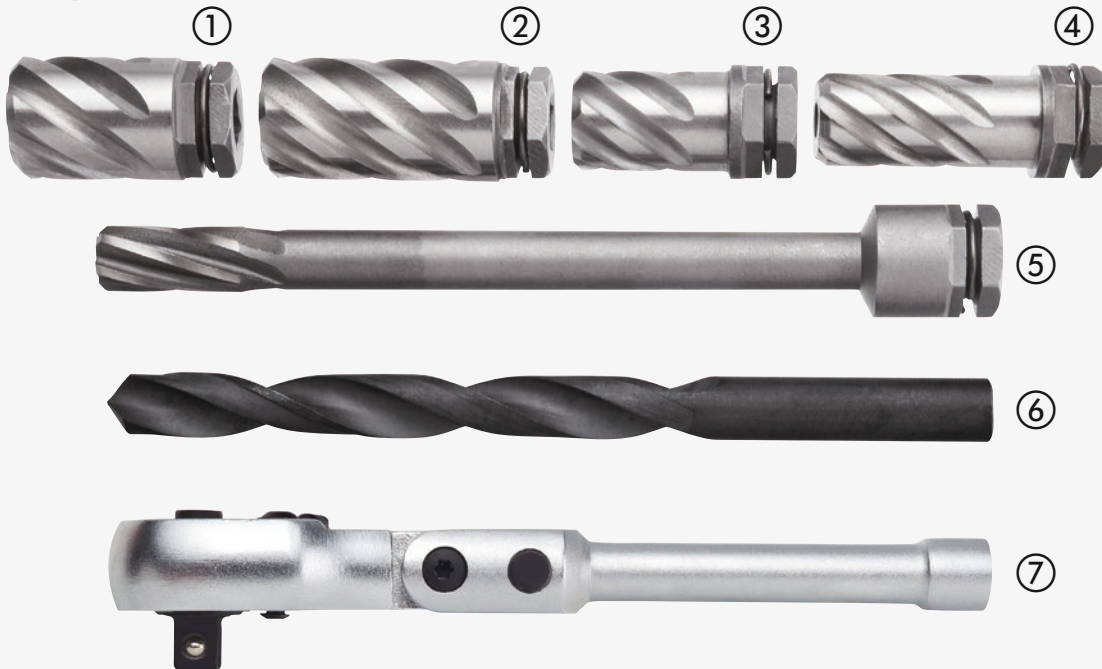

NR.	VIGOR No.	Bezeichnung	EAN 4047728+
1	V3698	Reibahle \varnothing 18x23 mm	036986
2	V3697	Reibahle \varnothing 18x34 mm	036979
3	V3699	Reibahle \varnothing 15 mm x 23 mm	036993
4	V3694	Reibahle \varnothing 14 x 32 mm	036948
5	V3695	Bohrer (Reibahle) \varnothing 10 x 133 mm	036955
6	V3696	Bohrer (Reibahle) \varnothing 10 x 133 mm	036962
7	V3693	Gelenk-Umschaltknarre $\frac{6.3}{14}$	036931



V4381, EAN 4047728043816

Adapter für Bremswartungs-Systeme

- Einsetzbar in Verbindung mit konventionellen Bremswartungs-Geräten
- Einfache und nützliche Ergänzung zur Verwendung von Wartungsgeräten an nahezu allen Fahrzeugen
- Deckel aus langlebigem Aluminium

Inhalt

- 1) Adapter E 20 W für schlecht zugängliche Ausgleichsbehälter, für nahezu alle europäischen Fahrzeuge
- 2) Adapter G 75 für ISUZU, MITSUBISHI, PROTON, SUBARU, SUZUKI, Volvo
- 3) Adapter B 35 für CHRYSLER, FORD, NISSAN, SUBARU, HYUNDAI
- 4) Universal-Adapter mit Kettenbefestigung



V4411, EAN 4047728**044110**

Manueller Bremsentlüfter-Satz

- Besonders geeignet für mobile Anwendung durch manuelle Druckaufbau-Funktion
- Zur Entlüftung u.a. von Brems- und Kupplungssystemen
- Betriebsdruck: max 1,4 bar
- Manometer-Bereich: 0-2 bar
- Ablassen des Drucks durch integriertes Druckablassventil
- Inhalt
 - 3 Liter Tank
 - E20 Euro-Adapter
 - Universal-Adapter mit Kette
 - Verbindungs-Schlauch mit Schnellanschluss
 - Auffangbehälter mit Anschlussnippel für Bremssysteme



3 Liter Fassungsvermögen





Bremsen

V4399, EAN 4047728043991

Bremsscheiben-Dickenmesser

- Schneller und effizienter Test zur Bestimmung der aktuellen Brems Scheibendicke
- Durchführung der Messung ohne Rad-Demontage

Hinweis: Mindestverschleißgrenzen der Brems Scheiben entnehmen Sie dem Fahrzeughersteller-Handbuch



***Schnell-Check -
Ohne vorherige
Rad-Demontage!***

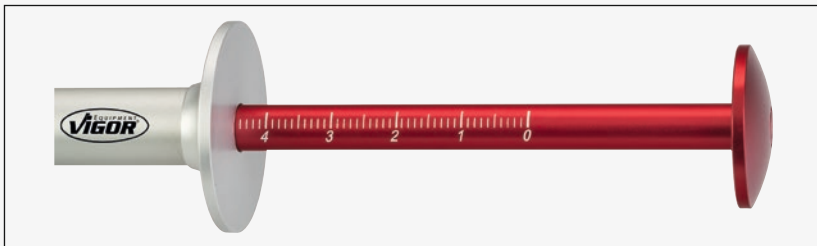

V4127, EAN 4047728**041270**

Führungsbolzen-Reparatur-Satz

- Schnelle und kostengünstige Reparatur des Innengewindes (M9x1,25 mm) am Radlagergehäuse / Bremsattelträger
- Einsatz von Gewindehülsen oder ähnlichen Reparaturen entfällt, es muss kein neuer Bremsführungsbolzen gekauft werden
- Erweitern des vorhandenen Gewindes auf M10x1,25 mm und mitgelieferten Führungsbolzen eindrehen
- Geeignet für folgende Fahrzeuge:
 VW Sharan, Touareg, Phaeton, Transporter Synchro, Transporter 1999 - 2010
 SEAT Alhambra
 AUDI A6, A8 (auch Quattro)



VIGOR No.	Bezeichnung		EAN
V4262	Bremsführungsbolzen M10x1,25	5	042628

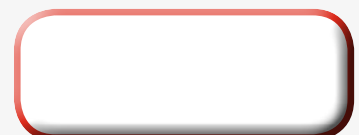

V4416, EAN 4047728044165

Bördelgerät für $\varnothing 4,75$ mm

- Leicht und handlich
- Pressdorn geeignet für metrische und 45° Doppelbördelungen
- Genaue Positionierung der Bremsleitung im Gerät erfolgt mittels Abstandadapter
- Besonders für direkten Einsatz an Brems – bzw. Hydraulikleitungen am Fahrzeug geeignet
- Für dünnwandige Stahl-, Aluminium- und Kupferleitungen (Metrisch / Zoll)
- Keine Beschädigung beschichteter Leitungen

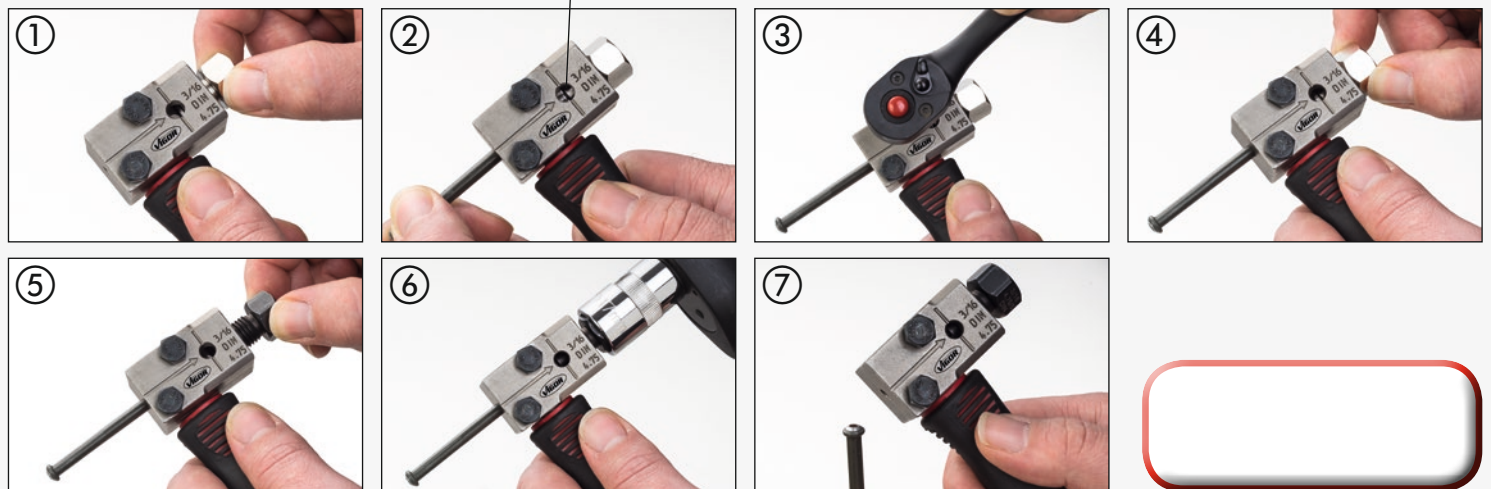

V1728, EAN 4047728**017282**

Bördelgerät-Satz

- Leicht und handlich
- Besonders für den direkten Einsatz an Brems- bzw. Hydraulikleitungen am Fahrzeug geeignet
- Für dünnwandige Stahl-, Aluminium- und Kupferleitungen Metrisch/Zoll
- Zur Anfertigung von Konvex und Doppelbördelungen (DIN/SAE-Standards)
- Keine Beschädigung beschichteter Leitungen



NR.	VIGOR No.	Bezeichnung	∅ mm	EAN 4047728+
1	V2466	Schnellwechsel-Halterung	-	024662
2	V2559	Grundgerät	-	025591
3	V2467	Hydraulik-Spindel	-	024679
4	V2558	Druckstück 90° DIN / SAE	4,75-6	025584
5	V2553	Druckstück DIN/SAE	5	025539
6	V2554	Druckstück DIN/SAE	4,75	025546
7	V2556	Druckstück DIN/SAE	6	025560
8	V2555	Druckstück DIN/SAE	6	025553
9	V2626	Rohrschneider, 3 - 22 mm	3-16	026260
10	V2551	Spannbacken-Paar	5	025515
11	V2552	Spannbacken-Paar	6	025522
12	V2540	Spannbacken-Paar	4,75	025409
13	V1782	Rohrbieger	-	017824

V2789, EAN 4047728027892

Inspektions-Werkzeug für Brems- und Kraftstoffleitungen

- Mit 12 Abstreichflächen zur Beseitigung von Schmutz und Korrosion verschiedener Leitungen
 - Scharf gebogene Abstreichflächen ermöglichen Zugriff an schwer erreichbaren Stellen
 - Zum Aufspüren verborgener Korrosionsstellen bei Hauptuntersuchung (HU)
- 0,1 kg



V2411, EAN 4047728024112

Bremssattel-Feile

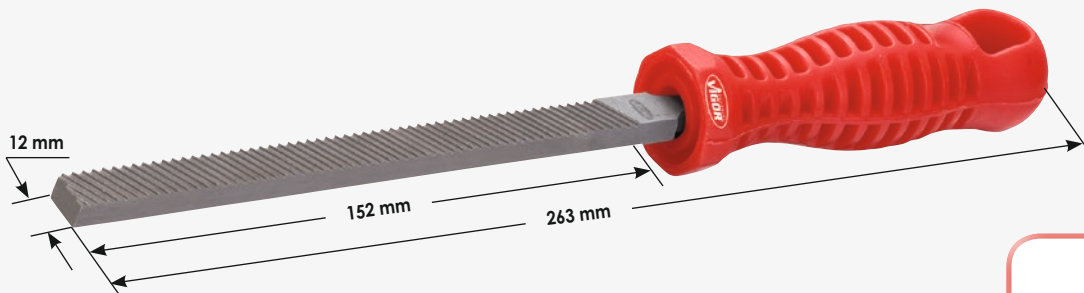

V2250, EAN 4047728022507

Bremssattel-Bürste, Stahl

- Zum Entfernen von hartnäckigem Bremsstaub
- Für enge Bremssattelschächte



V2249, EAN 4047728022491

Bremssattel-Bürste, Messing

- Zum Reinigen von Aluminium-Bremssätteln
- Zum Entfernen von hartnäckigem Bremsstaub
- Für enge Bremssattelschächte



V1805, EAN 4047728018050 Bremsleitungs-Schlüssel-Satz

- Mit Gelenk zur Anwendung an schwer zugänglichen Leitungsverschraubungen
- Besonders geeignet für den Einsatz unter beengten und schwierigen Platzverhältnissen wie z.B. an Brems-, Klima-, Servo-, Vakuum-, Druckluft- und Kraftstoffleitungen



Spezielles Wellenprofil

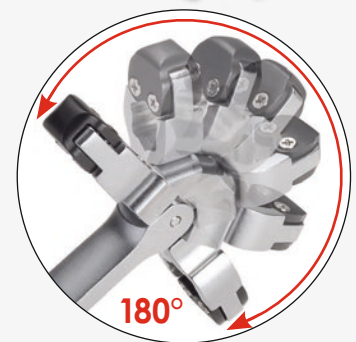

VIGOR No.	SW mm	L mm	EAN 4047728+
V1841	8x9	120	018418
V1842	10x11	160	018425
V1843	12x13	180	018432
V1844	14x15	210	018449



Spezielles Wellenprofil

2 Größen pro Schlüssel

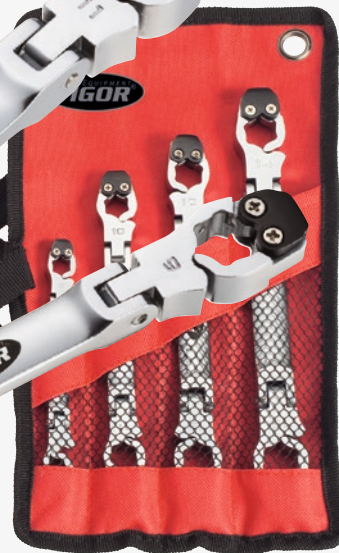

V1782, EAN 4047728017824 Rohrbieger

- Für Kupfer-, Messing-, Alu- und Weichstahlrohre



V3730, EAN 4047728**037303**

Leitungsschlüssel-Satz

- Für Verschraubungen an Brems-, Kraftstoff-, Hydraulik- und Klimaleitungen
- Schlüsselköpfen arbeiten wie Federscharniere
- Abgenutzte, beschädigte oder zu kleine Verschraubungen werden fest umschlossen
- Drehmomentabhängiger Klemm-Mechanismus:
Je höher das Drehmoment, desto besser die Klemmung
- Passt sich sowohl metrischen als auch Zollgrößen an

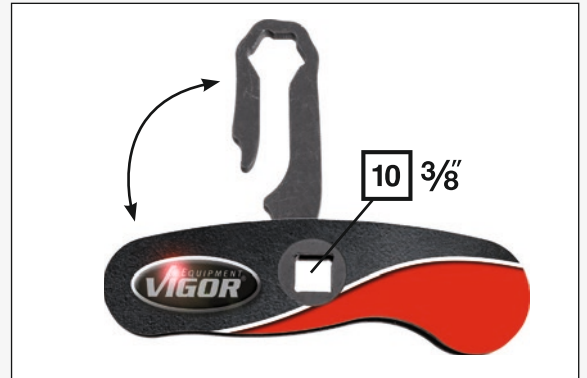

VIGOR No.	SW mm	EAN 4047728+
V3703	10	037037
V3704	11	037044
V3705	12/13	037051
V3706	14	037068

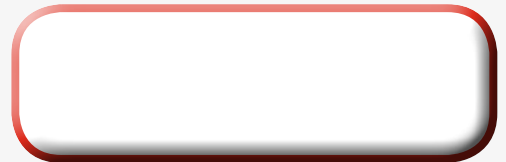



V3760, EAN 4047728037600

Bremskolben-Rückstell Werkzeug-Satz

- Neues System für links- und rechtsdrehende Kolben
- Adapter ermöglichen Einsatz auch bei stark abgefahrenen Belägen sowie den Zusammenbau der Rücksteller im Bremsattel
- Inhalt:
 - 2 Spindeln (links- und rechtsdrehend)
 - 2 Winkelschlüssel (6 und 7 mm)
 - 2 Splintreiber
 - 3 austauschbare Rückhalteplatten
 - 31 Rückhalteplatten und Adapter
 - 1 Gewindeölfasche



V1711, EAN 4047728017114

Pneumatischer Bremskolben-Rückstellwerkzeug-Satz

- Universeller Satz zum Drehen und Drücken von Bremskolben an nahezu allen Pkw
- Drehbewegung rechts und links möglich
- 16-teiliger Satz bestehend aus:
 - 1 Druckluftspindel und 15 Adapterplatten





Räder/Reifen

V4195, EAN 4047728**041959**

Kreuzschlüssel

- Für Pkw und Transporter
- Größen: 17x19x21 mm x $12\frac{5}{8}$ "
- Oberfläche: verchromt
- DIN 3119

$12\frac{5}{8}$ "

$12\frac{5}{8}$ "



SW 17 mm

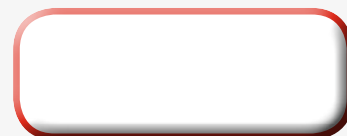

V4309, EAN 4047728**043090**

Spezial Kraft-Steckschlüssel

MERCEDES-BENZ

- Zum Lösen und Festziehen von Radschrauben mit neuem MERCEDES-BENZ Spezialprofil
- Passend für MERCEDES-BENZ, z.B.:
C-Klasse / GLK (W204),
E-Klasse (W211, W212, W207),
SLK (W172),
M-Klasse (W164, W166),
CL-Klasse (W216),
S-Klasse (W221, W222)
MAYBACH

$12\frac{5}{8}$ "



78 mm

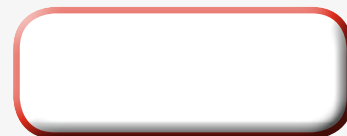

V2257, EAN 4047728022576

12⁵ 1/2 Schlagschrauber-Steckschlüssel-Satz



VIGOR No.	SW mm	L mm	EAN 4047728+
V2471	15	85	024716
V2472	17	85	024723
V2473	19	85	024730
V2474	21	85	024747
V2475	22	85	024754



Schlagschrauber
siehe S. 130



V2522, EAN 4047728025225

12⁵ 1/2 Schlagschrauber-Steckschlüssel-Satz



VIGOR No.	SW mm	L mm	EAN 4047728+
V2472	17	85	024723
V2473	19	85	024730
V2474	21	85	024747

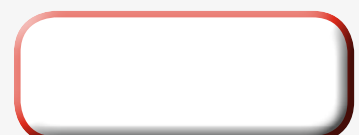

V4366, EAN 4047728**043663**

Felgenschloss-Sortiment, BMW „Vielzahn-Profil“

- BMW Felgenschlösser passend für BMW Felgensicherungen mit „Stern-Profil“
- Satz enthält folgende Größen mit Lochung:
30/13PT, 31/15PT, 32/16PT, 33/17PT, 34/18PT, 35/19PT, 36/20PT, 37/21PT, 38/22PT, 40/23PT
- Satz enthält folgende Größen ohne Lochung:
13/16PT, 12/14PT, 11/15PT, 16/10PT, 15/11PT, 14/12PT, 19/8PT, 18/13PT, 17/7PT, 20/9PT

Hinweis: Betätigung mit Schlagschrauber wird nicht empfohlen!



20

NEU

V4367, EAN 4047728**043670**

Felgenschloss-Sortiment, VAG „Vielzahn-Profil“

- VAG Felgenschlösser passend für VAG Felgensicherungen mit „Stern-Profil“
- Satz enthält folgende Größen mit Lochung:
51/5PT, 52/7PT, 53/8PT, 54/9PT, 55/10PT, 56/11PT, 57/12PT, 58/13PT, 59/14PT, 60/15PT, 61/16PT, 62/17PT
- Satz enthält folgende Größen ohne Lochung:
ABC0/10PT, ABC1/11PT, ABC2/13PT, ABC3/14PT, ABC4/15PT, ABC5/16PT, ABC6/17PT, ABC7/19PT, ABC8/20PT, ABC9/21PT

Hinweis: Betätigung mit Schlagschrauber wird nicht empfohlen!

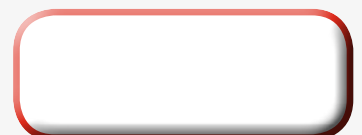

22

NEU

V4365, EAN 4047728**043656**

Felgenschloss-Sortiment, BMW „Kleeblatt-Profil“

- BMW Felgenschlösser passend für BMW Felgensicherungen mit „Kleeblatt-Profil“
- Satz enthält folgende Kennungen:
41, 42, 43, 44, 45, 46, 47, 48, 49, 50, 51, 52, 53, 54, 55, 56, 57, 58, 59, 60

Hinweis: Betätigung mit Schlagschrauber wird nicht empfohlen!

20

NEU

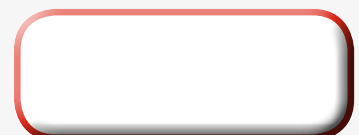
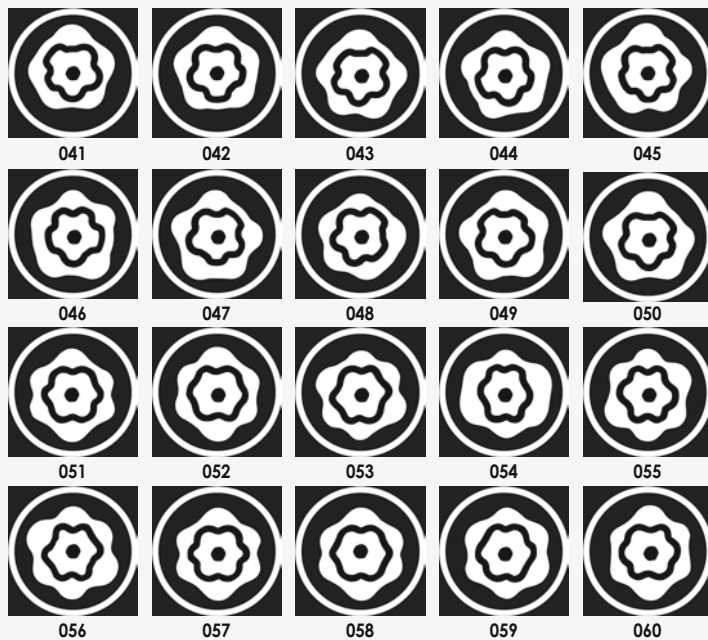

V4431, EAN 4047728**044318**

Werkzeug-Satz für Reifendruck-Kontroll-Systeme (RDKS)

- Inklusive 2 Drehmoment-Schraubendreher für präzise Anzugsmomente von 0,2–2 Nm und 2–10 Nm
- Zur einfachen und fachgerechten Montage von Sensor und Ventil an jeder Felge
- Zum Ein- und Ausdrehen der Ventileinsätze



6.3 1/4 **6.3 1/4**

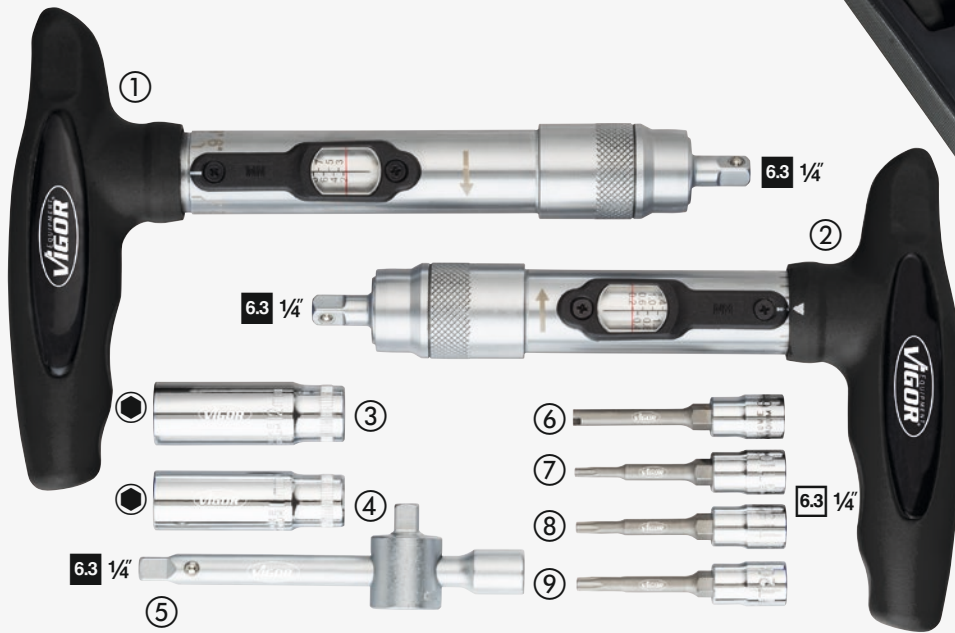

Nr.	VIGOR No.	SW mm	l mm	EAN 4047728+
1	V4431-1	6.3 1/4 2–10 Nm	190	044325
2	V4431-2	6.3 1/4 0.2–2 Nm	170	044332
3	V2700	12	50	027007
4	V2699	11	50	026994
5	V2453	6.3 1/4 6.3 1/4	110	024532
6	V4431-3	-	55	044349
7	V4431-4	T10	55	044356
8	V4431-5	T15	55	044363
9	V4431-6	T20	55	044370



V2479, EAN 4047728024792

Flaschenwagenheber 2 t

- Horizontaler und vertikaler Einsatz möglich
- ⚖️ 2,3 kg

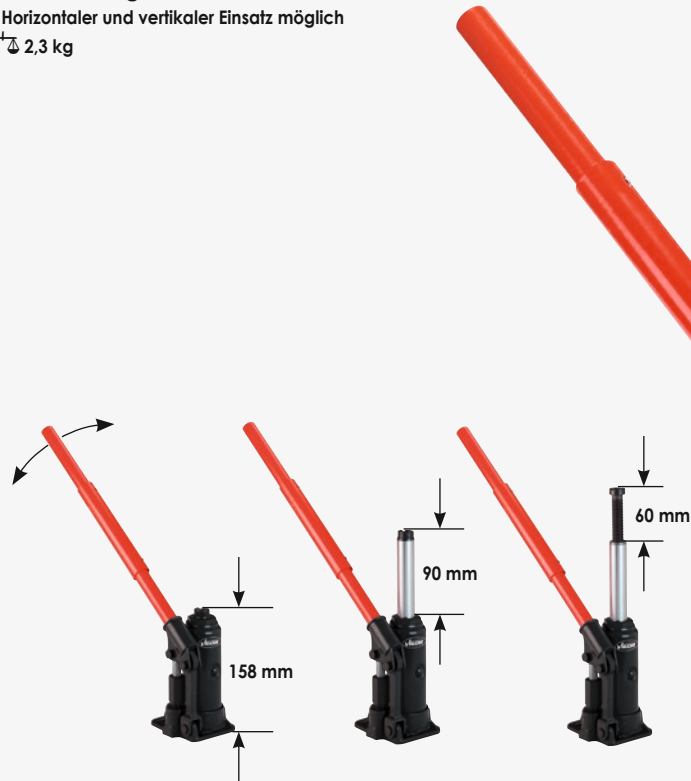

V2478, EAN 4047728024785

Flaschenwagenheber 6 t

- Horizontaler und vertikaler Einsatz möglich
- ⚖️ 4,4 kg

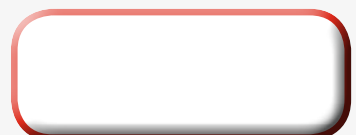
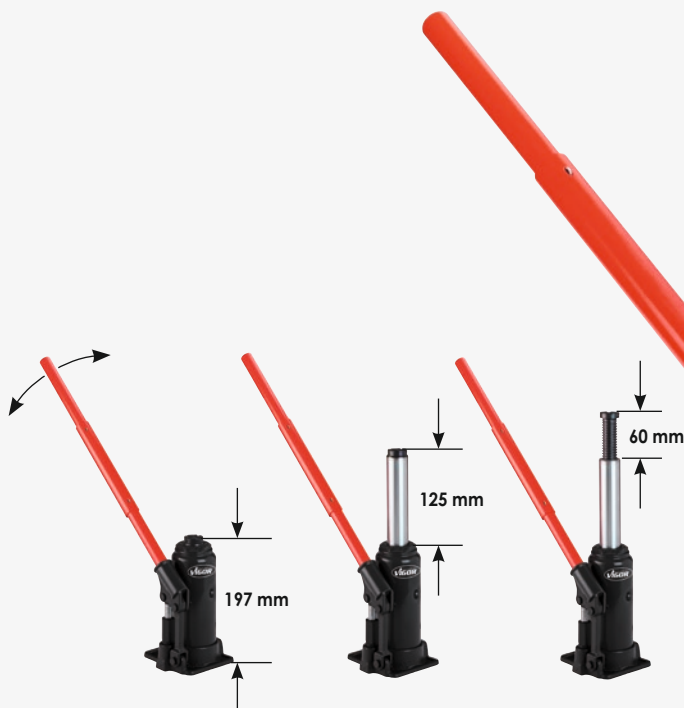



Räder/Reifen



V2481, EAN 4047728024815

Hydraulik Alu-Rangier-Wagenheber 1,35 t

⚖️ 10 kg



**Alu -
nur 10 kg**



VIGOR No.	Bezeichnung	EAN 4047728+
V2640	Gummi-Auflage	026406
V2632	Lenkrollen-Paar	026321
V2631	Bockrollen-Paar	026314
V2639	Hydraulik-Einheit	026390

Räder/Reifen



V2649, EAN 4047728026499
 Hydraulik-Rangier-Wagenheber 2 t
 ⚖️ 38 kg

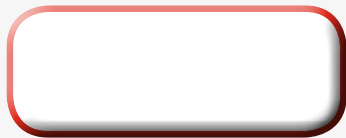
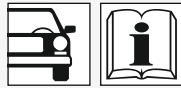

**Extra
flach!**



VIGOR No.	Bezeichnung	EAN 4047728+
V3639	Gummi-Auflage	036399
V3638	Lenkrollen-Paar	036382
V3637	Bockrollen-Paar	036375
V3640	Hydraulik-Einheit	036405

V2480, EAN 4047728024808
 Hydraulik-Rangier-Wagenheber 3 t
 ⚖️ 42,0 kg

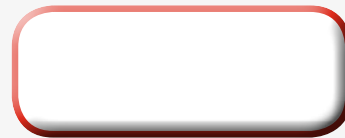
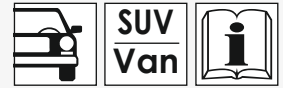

VIGOR No.	Bezeichnung	EAN 4047728+
V2637	Gummi-Auflage	026376
V2633	Lenkrollen-Paar	026338
V2634	Bockrollen-Paar	026345
V2638	Hydraulik-Einheit	026383



Räder/Reifen

V2477, EAN 4047728**024778**

Unterstellböcke 3 t

5,2 kg pro Paar



VIGOR No.	Bezeichnung	EAN
V2762	Gummi-Auflage	027625



V2648, EAN 4047728**026482**

Unterstellbock-Satz 6 t

11 kg pro Paar



VIGOR No.	Bezeichnung	EAN
V2761	Gummi-Auflage	027618

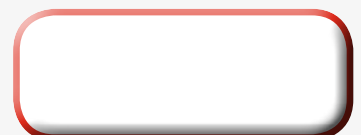

V3564, EAN 4047728**035644**

Reifen- und Montagehebel

- Für Pkw und Transporter
- Doppel-T-Profil für hohe Stabilität



SUV
Van



V3563, EAN 4047728**035637**

Reifen- und Montagehebel mit Kunststoff-Belag

- Zum Auf- und Abziehen der Reifen an Stahl- und insbesondere Alu-Felgen



SUV
Van



VIGOR No.	Bezeichnung	EAN
V3615	Kunststoff-Belag inkl. Schrauben	036153

V2512, EAN 4047728**025126**

Klebegewicht-Entferner-Satz

- Lösemittelbeständig
- Mittels Feile nachschleifbar
- Oberflächen werden nicht beschädigt
- Ideal zur Demontage von Klebegewichten auf Alufelgen bei Pkw und Motorrad
- Auch zum Ablösen von Etiketten, Klebe- und Typenschildern

VIGOR No.	Breite mm	EAN 4047728+
V2513	19	025133
V2514	22	025140
V2515	25	025157
V2516	38	025164



V2514, EAN 4047728**025140**

Klebegewicht-Entferner

Topseller!

22 mm



V1657, EAN 4047728**016575**

Auswuchtgewicht-Zange



190

250 mm

V1584, EAN 4047728015844

Profiltiefenmesser

- Nullstellung in jeder Position möglich
- Verwendbar zur Messung von Profiltiefen, Bremsklötzen und Bremsbelägen
- 3 V (CR 2032) - 240 mAh

max. 27 mm →



V1423, EAN 4047728014236

Reifendrucktester

- Messbereiche:
0,15 – 7 bar
2 – 99,5 PSI
15 – 70 KPA
- 3 V (CR 2032) – 240 mAh



Automatische Abschaltung nach 90 sek.



V1378, EAN 4047728013789

Spezial-Ausdreh-Steckschlüssel-Einsätze



- Spezialprofil zum Lösen von Felgenschlüssern, festsitzenden Radbolzen und Müttern mit rundgedrehten Köpfen
- Steckschlüssel-Einsätze zweiseitig verwendbar:
1. Als normaler Steckschlüsseleinsatz /
2. Als Spezial-Schneidgewinde
- Satz bestehend aus:
 1/2 SW 17 mm
 1/2 SW 19 mm
 1/2 Verlängerung - 60 mm

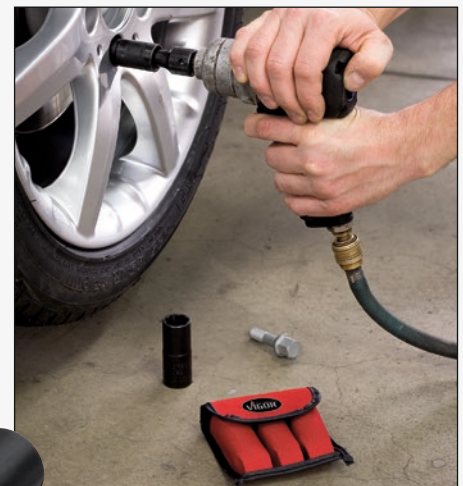

Maschinenbetätigt



V2235, EAN 4047728022354

Gummihammer 2,5 kg

- Speziell zum Lösen festgerosteter Felgen beim Reifenwechsel



V2234, EAN 4047728022347

Gummihammer 5 kg

- Extra schwere Ausführung, besonderes geeignet für Nfz
- Speziell zum Lösen festgerosteter Felgen beim Reifenwechsel



V1571, EAN 4047728015714

Lenkrad-Einstellwaage

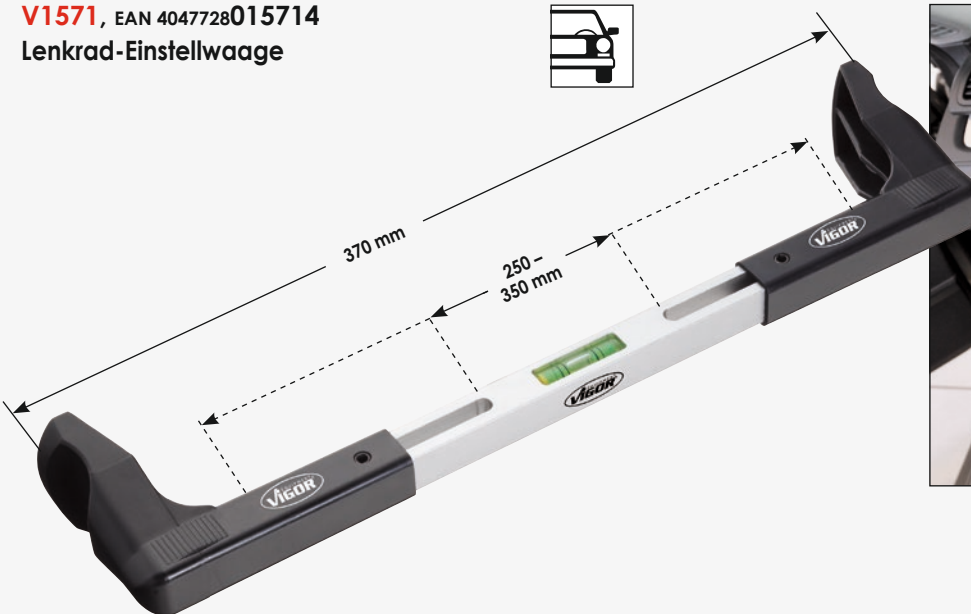

V2236, EAN 4047728**02236** 1

Spannratsche

- Zur einfachen Montage für Band- und Schlaufen- (Free-end) Schellen oder auch vorgefertigten Schellen
- Für Bandschellen mit einer Breite von 6 – 10 mm



V2391, EAN 4047728**02391** 7

Metall-Spannband-Satz

- 20 Stück/Satz
- In Verbindung mit Spannratsche V2236

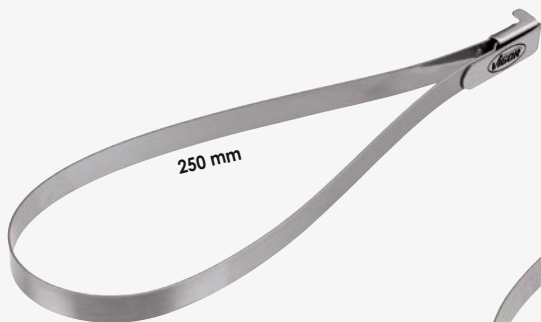

250 mm



V2392, EAN 4047728**02392** 4

Metall-Spannband-Satz

- 20 Stück/Satz
- In Verbindung mit Spannratsche V2236



480 mm

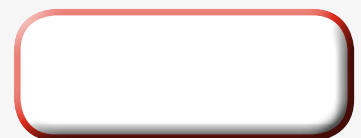

V3551, EAN 4047728035514

Kunststoff-Reparatur-Satz

- Zur Reparatur und Verstärkung von Kunststoffteilen wie z.B. gerissene Lampenbügel und Gehäuseteile
- In wenigen Minuten ist ein Bauteil formstabil repariert und für eine mögliche Weiterverarbeitung wie z. B. Lackierung oder Spachteln vorbereitet.
- Elektrische Leistung: 100–240 V - 50 / 60 Hz
Max: Bis zu 20 W
- Inhalt:
100 Klammern Typ V / \varnothing 0,6 mm
100 Klammern Typ W / \varnothing 0,6 mm
100 Klammern Typ W / \varnothing 0,8 mm



Im Satz enthalten:



Typ V / \varnothing 0,6 mm Typ W / \varnothing 0,8 mm Typ W / \varnothing 0,6 mm

Zusätzlich erhältlich:

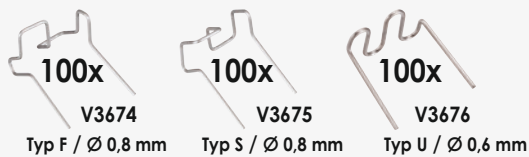

Typ F / \varnothing 0,8 mm Typ S / \varnothing 0,8 mm Typ U / \varnothing 0,6 mm



Typ U / \varnothing 0,8 mm Typ M / \varnothing 0,6 mm



VIGOR No.	Bezeichnung		EAN 4047728+
V3671	Klammern, V-Format 0,6 mm	100	036719
V3672	Klammern, W-Format 0,8 mm	100	036726
V3673	Klammern, W-Format 0,6 mm	100	036733
V3674	Klammern, F-Format 0,8 mm	100	036740
V3675	Klammern, S-Format 0,8 mm	100	036757
V3676	Klammern, U-Format 0,6 mm	100	036764
V3677	Klammern, U-Format 0,8 mm	100	036771
V4400	Klammern, M-Format 0,6 mm	100	044004

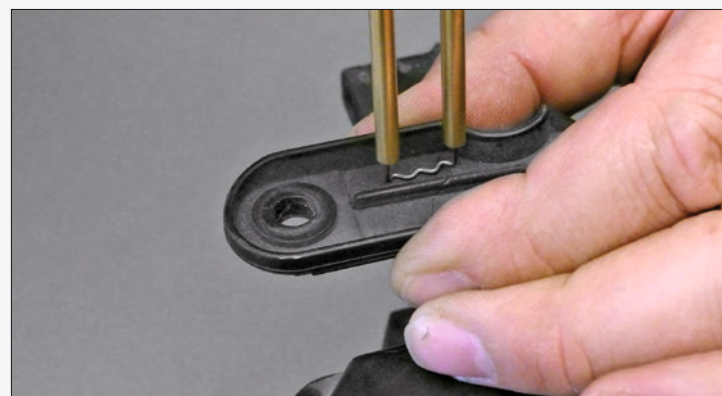

V2523, EAN 4047728**025232**

Scheibenwischerarm-Abzieher-Satz

- Universell verwendbar
- Ermöglicht einen problemlosen Ausbau aller gängigen Wischerarme
- Optimale Einsatzmöglichkeiten bei gerosteten und festsitzenden Wischerarmen
- Größtmöglicher Schutz für integrierte Wischerdüsen bei Anwendung mit Schlagauszieher



NR.	VIGOR No.	Bezeichnung	EAN 4047728+
1	V4153	Universalsabzieher	041539
2	V4154	Schlagauszieher	041546
3	V4155	Druckspindel	041553
4	V4156	Spindelverlängerung	041560
5	V4157	Spindelvorsatz	041577
6	V4159	Zugglocke 1	041591
7	V4160	Zugglocke 2	041607
8	V4161	Zugglocke 3	041614
9	V4162	Zugglocke 4	041621
10	V4163	Zugglocke 5	041638
11	V4164	Zugglocke 6	041645
12	V4165	Zugglocke 7	041652
13	V4158	Zugglocke 8	041584



V2685, EAN 4047728026857

Saugheber



V4193, EAN 4047728041935

Druckkissen-Satz

Einsetzbar für folgende Anwendungen, z. B.:

- Zum beschädigungsfreien Öffnen von Fahrzeugtüren
- Zum Positionieren, Fixieren und Abdrücken von Karosserieteilen, Innenverkleidungen etc.
- Nivellierhilfe beim Einbau von Fenster- und Türrahmen

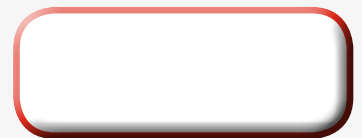

Spurstangen-Gelenk-Werkzeug

- Zum fachgerechten und schnellen Austausch von Spurstangen-Axialgelenken an Pkw und leichten Nfz
- Problemlose Montage längerer Spurstangen durch offene Bauweise

V2684, EAN 4047728**026840**

Für Spurstangenköpfe 28 - 35 mm Ø



V2683, EAN 4047728**026833**

Für Spurstangenköpfe 35 - 45 mm Ø



V3863, EAN 4047728038638

Stoßdämpfer-Montagewerkzeug-Satz

- Zur Demontage und Montage an Stoßdämpfern mit Zuganschlagfeder
- Spezielle Konstruktion ermöglicht fachgerechtes Hochziehen der Kolbenstange ohne Verkanten
- Fixierung mittels Klemmstücke mit V-Form Kunststoffeinsätzen in Endanschlagposition ohne Beschädigung
- Für: BMW, FIAT, FORD, MERCEDES-BENZ, NISSAN, PEUGOT, TOYOTA
- Inhalt:
Spezial-Grundkörper
Robuste M12 Gewindespindel mit Spezialaufnahme
Universal-Klemmstück mit V-Form-Kunststoffeinsätzen

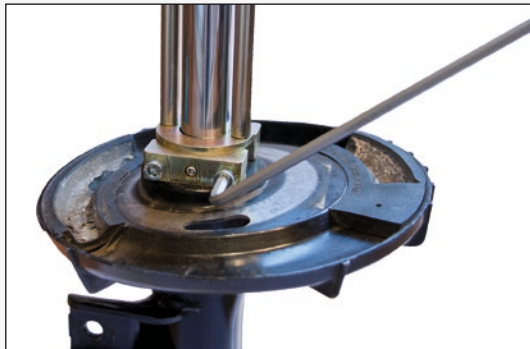
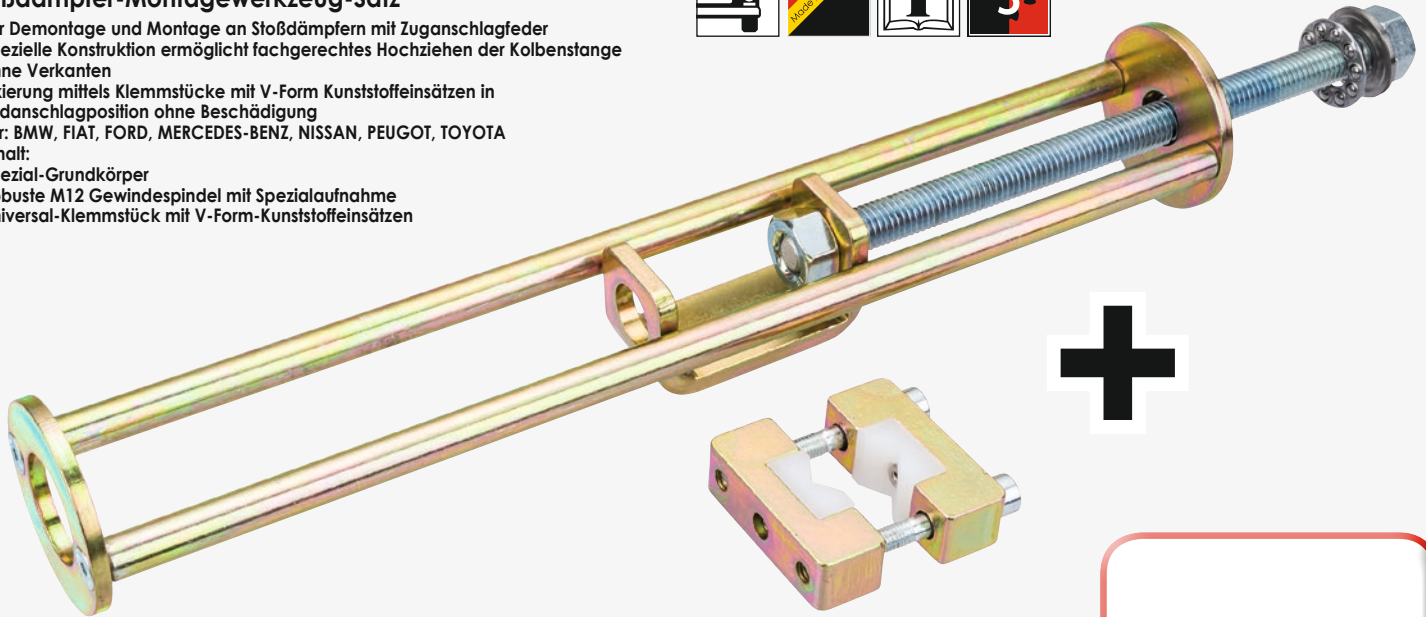

V3661, EAN 4047728036610

Klemmstück mit Kunststoff-Schonbacken (universal)

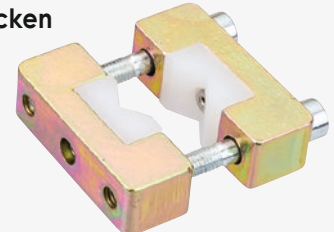

V3308, EAN 4047728033084

Kugelgelenk-Abzieher, hydraulisch

- Zum Ausdrückenn der Kugelgelenkzapfen an Spurstangen, Stabilisatoren usw. für die gängigsten Fahrzeugmarken



Hydraulikspindel,
Kraft: 8 t

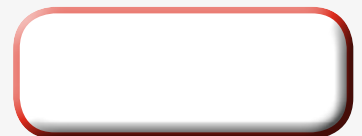

V4126, EAN 4047728**041263**

Klemmschrauben-Demontage-Werkzeug-Satz für Vierlenker-Achse VAG

- Spezialwerkzeug zum Lösen der Klemmschraube an der Vierlenkerachse bei VAG-Fahrzeugen, z. B. AUDI A4, A6 etc.
- Einsetzbar auch bei Aluminium-Achsschenkeln
- Inhalt:
3 Hochleistungsbohrer (HSS Cobalt), Größe: 6 8,5 10 mm
1 Andrückbügel
1 Ausschlag-Werkzeug
- Mit max. 600U/min bohren



6 mm

8,5 mm

10 mm



①



②



③

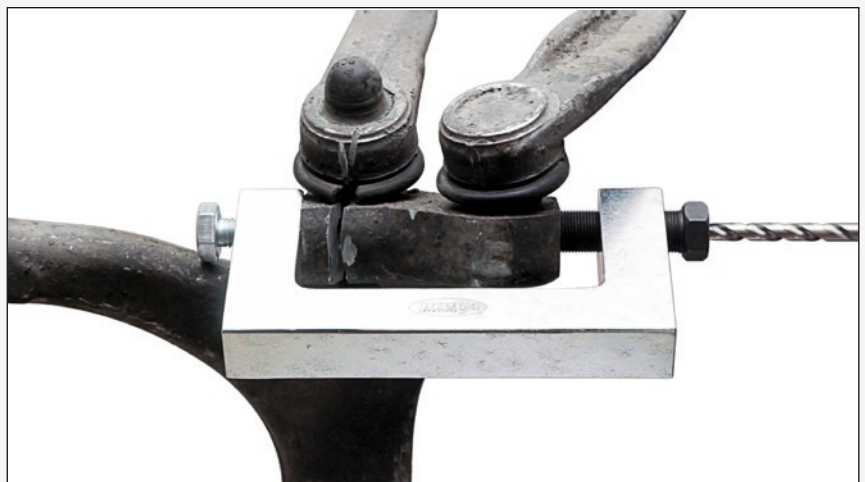

Nr.	VIGOR No.	Bezeichnung	EAN 4047728+
1	V4248	HSS-Bohrer 6 mm	042482
2	V4249	HSS-Bohrer 8,5 mm	042499
3	V4250	HSS-Bohrer 10 mm	042505

DAFÜR

BRENNE

ICH!





VIGOR EQUIPMENT[®]

DAFÜR BRENNNE ICH!

Sprechen Sie uns an:

